



BEST CHOICE
PRODUCTS



INSTRUCTION MANUAL

5-in-1 Outdoor
Sport & Center

! NOTICE

Please retain these instructions for future reference.

- This product requires adult assembly and supervision when in use.
- Please read all instructions before attempting to install or assemble this item. Assembly should be done by adults only.
- Firmly secure all screws before use.
- Reconfirm that all bolts, screws, and knobs are secure before every use.
- Product is intended for outdoor use.
- If any parts are missing, broken, damaged, or worn, stop using this item until repairs are made and/or factory replacement parts are installed.
- Do not use this item in a way inconsistent with the manufacturer's instructions as this could void the product warranty.
- Assemble this product on a flat level surface near its intended space.
- This product is intended for residential use only.

! WARNING

- Do not hang from the rim or climb on the pole. Do not climb on the base or structure in general, as this could result in serious injuries.
- Do not overtighten the hardware as this may damage the products structure.
- Adjustment and moving of the basketball set must be carried out by adults.
- The set requires two people for assembly.

TOOLS REQUIRED



WRENCH
(2, PROVIDED)



14MM WRENCH
(NOT PROVIDED)

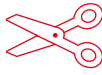

SCISSORS
(NOT PROVIDED)



INTENDED
FOR AGES 8+



2 PERSON
ASSEMBLY



UP TO 75 MIN.
ASSEMBLY

HARDWARE

1

CONNECTOR
KNOB



1 PC

2

8 x 50mm
BOLT &
WASHER SET



8 PCS

3

8 x 30mm
BOLT &
WASHER SET



4 PCS

4

8 x 15mm
BOLT &
WASHER SET



2 PCS

5

NET BUNGIE



28 PCS

6

NET ROPE



2 PCS

PARTS

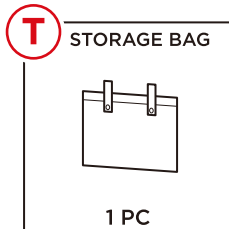
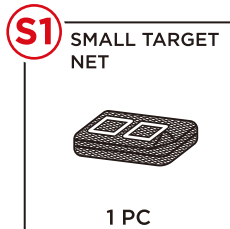
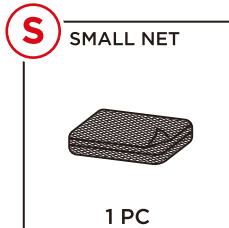
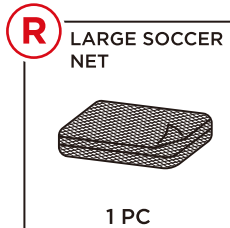
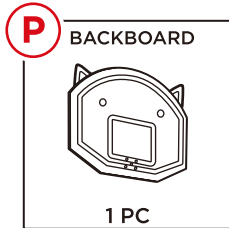
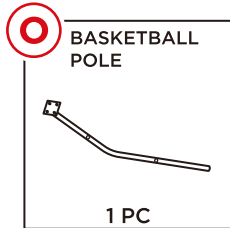
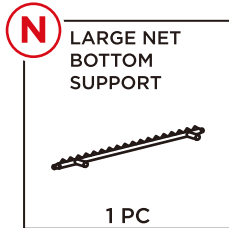
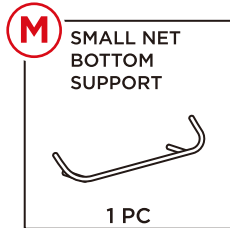
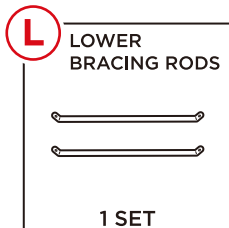
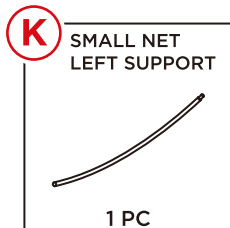
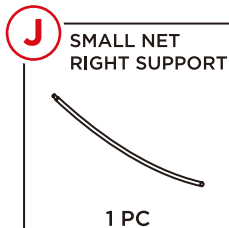
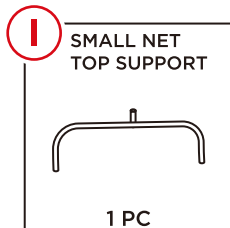
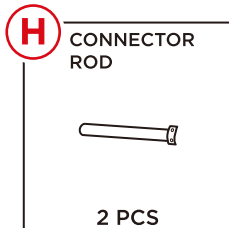
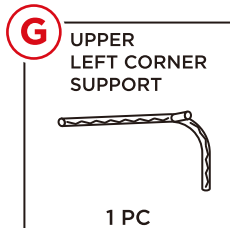
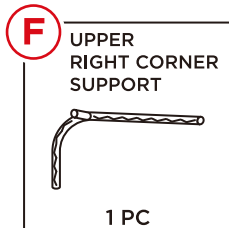
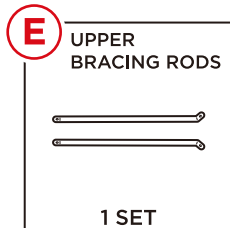
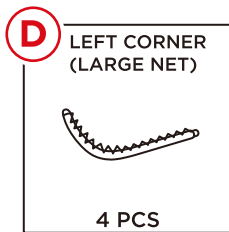
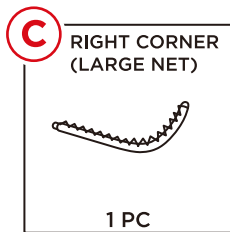
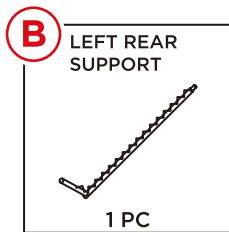
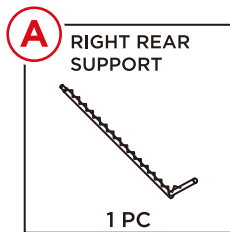

PRODUCT ASSEMBLY

1 Connect the **part A right rear support** to the **part C right corner**, then repeat to connect the **part B left rear support** to the **part D left corner**.

2 Connect the two corner assemblies with the **part N large soccer net bottom support**.

3 Locate and connect **parts F & G upper corner supports**, then attach the upper corners to the **part A & B rear supports**.

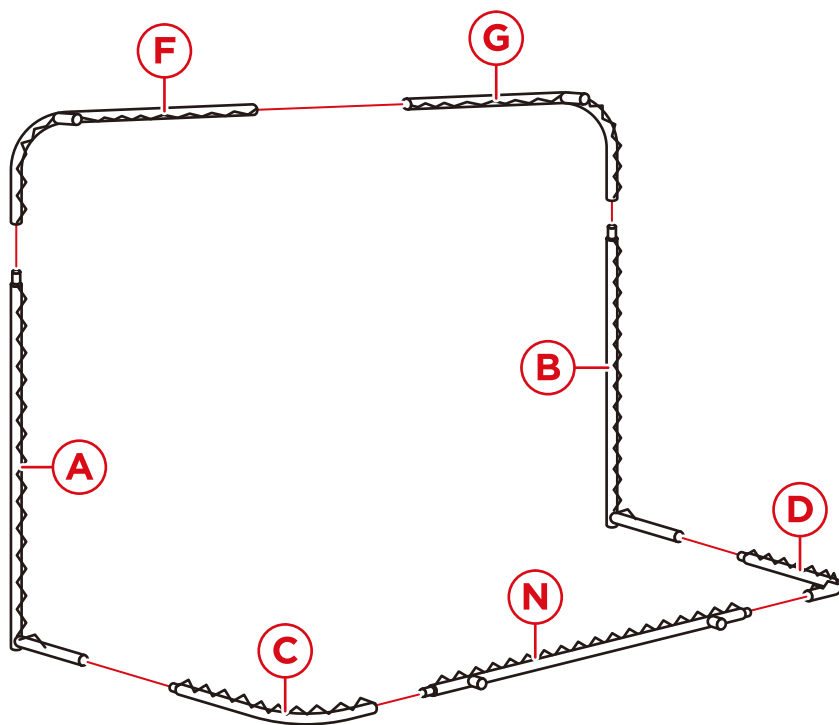

PRODUCT ASSEMBLY

4

Use the **part 6 net rope** to attach the **part R large soccer net** to the assembled large net frame (see steps 1-3).

Begin by draping the net over the frame to reach the optimum shape, then thread the **part 6 net rope** through the net ridge around either the **part A or B corners** and tie a knot.

Continue threading the rope around the frame ridges and through the **part R soccer net**, then tie a second knot to secure the net to the frame. Use scissors to cut away excess rope.

5

Locate and attach the **part I small net top support** to the **part J & K side supports**.

Attach the **part M small net bottom support** to the **part J & K side supports**.

NOTE: The the part I small net top support has a fastening hole in it's upper receiver. This hole should face the back of the frame assembly.

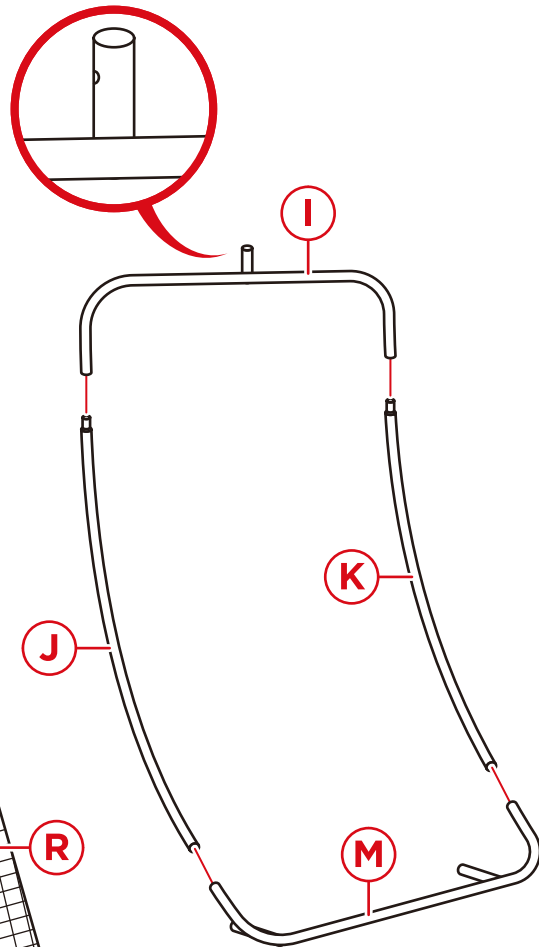
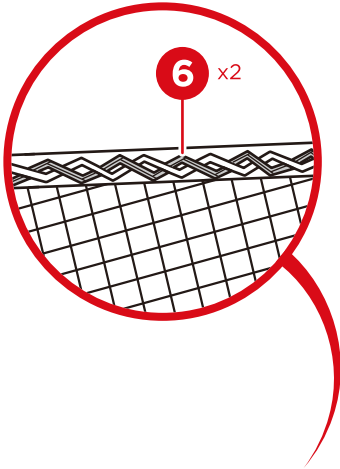

PRODUCT ASSEMBLY

6

Use the **part 5 net bungies** to attach one **part S1 small net** to the small net frame assembly.
NOTE: Part S1 net is shown, but interchangeable with **part S small net**.

Begin by draping the net over the frame to reach the optimum shape, then take one bungee, loop the cord around the frame and thread through the net. Insert the end of the bungee back into bungee's knot and pull until taught. Repeat with the remaining bungies until the net is completely secured.

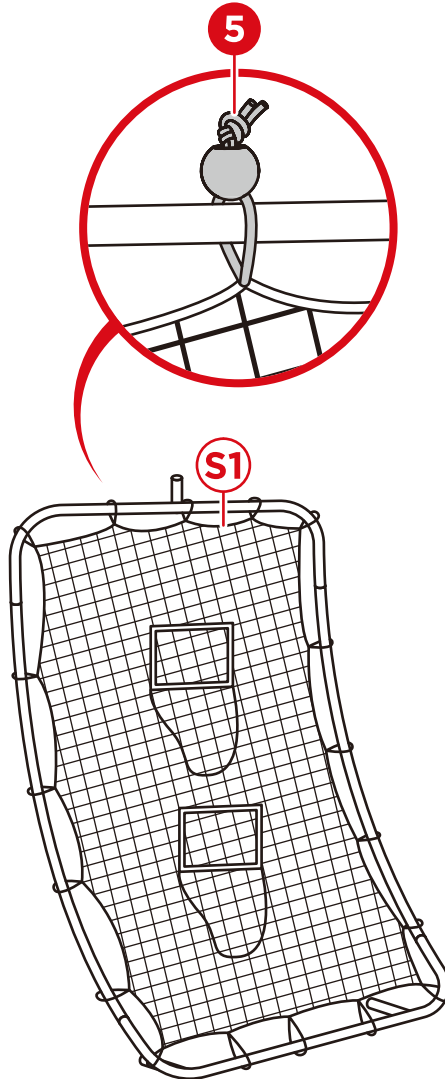

PRODUCT ASSEMBLY

7

Insert two **part H connector rods** into the **part F & G upper corners**, then attach the assembled small net with four **part 2 screws**, two screws per connector. Connect the **part M & N bottom supports** as indicated. Assemble basketball hoop next.

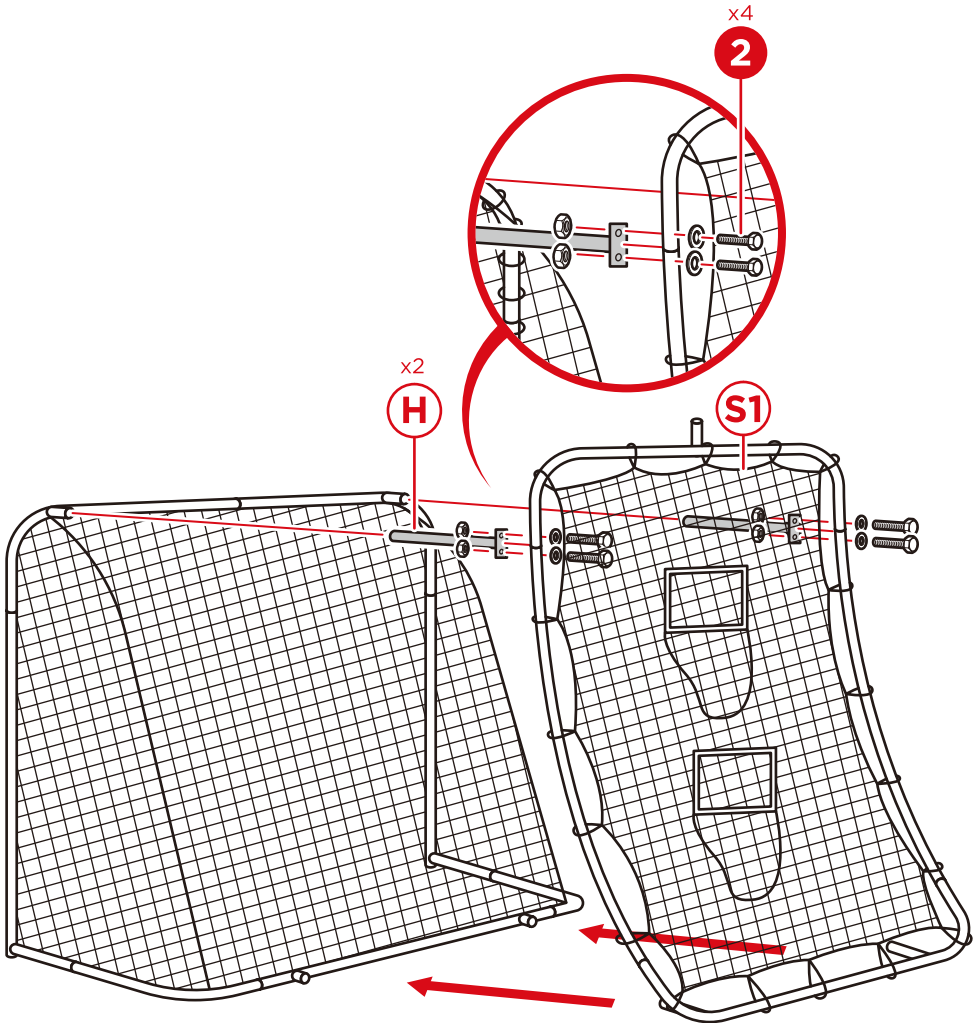

PRODUCT ASSEMBLY

8

Locate the **part Q** basketball hoop frame and attach the **part Q1** basketball hoop net.

9

Locate the **part O** basketball pole and attach the **part P** backboard & **part Q** basketball hoop frame with four **part 3** bolt & washer sets.

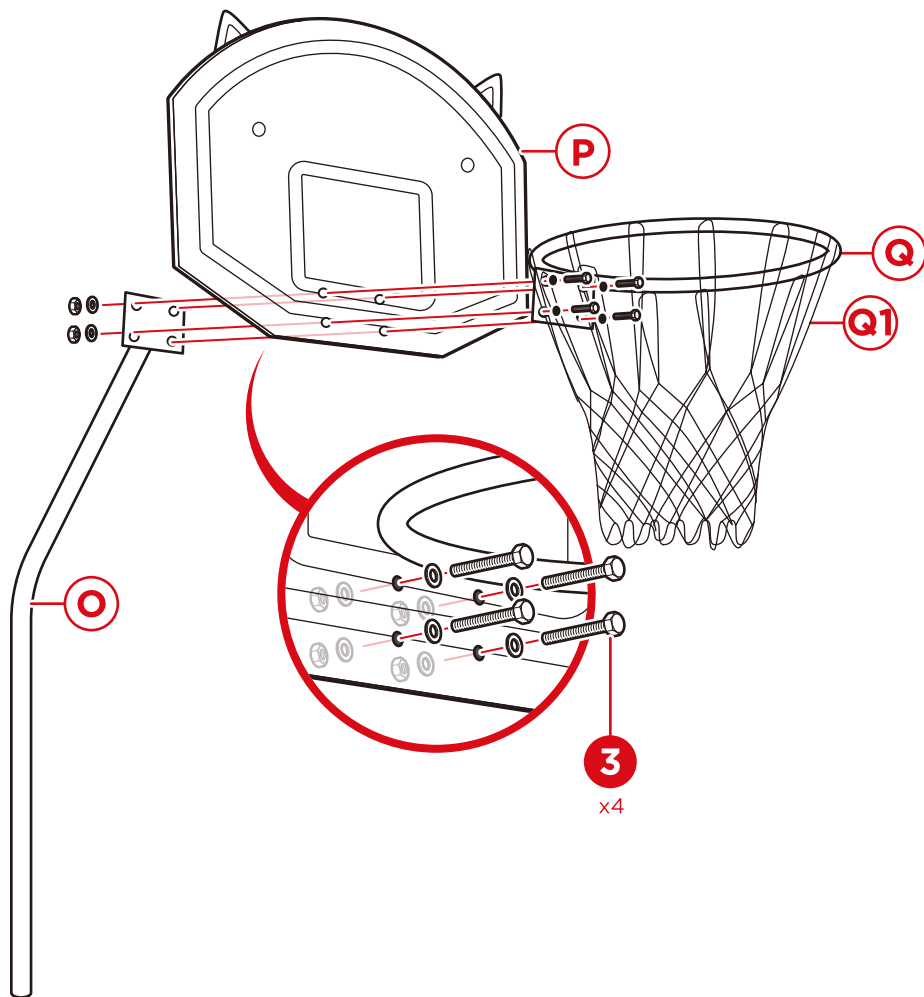

PRODUCT ASSEMBLY

10

Attach two **part E** bracing rods to the **part P** backboard with two **part 4** bolt sets.

NOTE: The bracing rods have two hole placements, one round and one slotted; attach the slotted end to the **part P** backboard.

Secure the **part O** basketball pole to the **part P** backboard by attaching two **part E** bracing rods with one **part 2** bolt & washer set, remove the washer for a tighter fit.

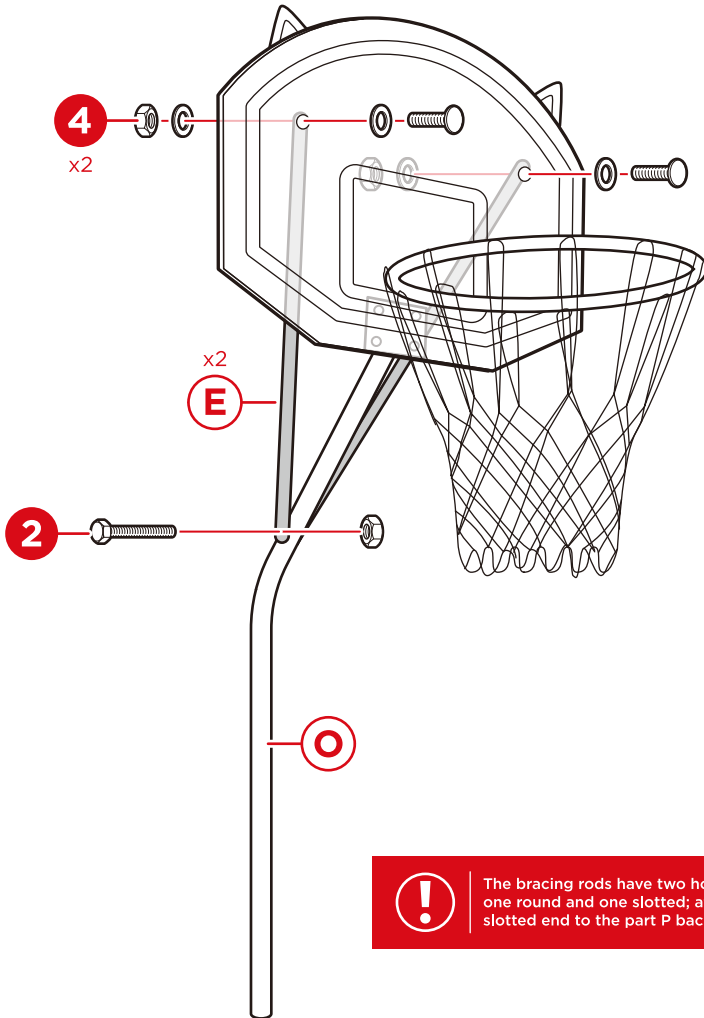

The bracing rods have two hole placements, one round and one slotted; attach the slotted end to the part P backboard.

PRODUCT ASSEMBLY

11

Insert the **part O basketball pole** into the opening on the **part I small net top support** and secure with one **part 1 connector knob**. Firmly twist the knob to secure the pole.

Attach two **part L lower bracing rods** to the **part O basketball pole** with one **part 2 bolt & washer set**. Remove the washer for a tighter fit.

Attach the two **part L lower bracing rods** to **part I small net top support** with two **part 2 bolt and washer sets**.

12

Locate the **part T storage bag** and unbutton the straps, loop the straps around one of the part H connector rods and button the straps to secure.

RECOMMENDED: The **part O basketball pole** may loosen after multiple impacts, check and tighten the **part 1 knob** regularly.

The bracing rods have two hole placements, one round and one slotted; attach the round end to the part O basketball pole.

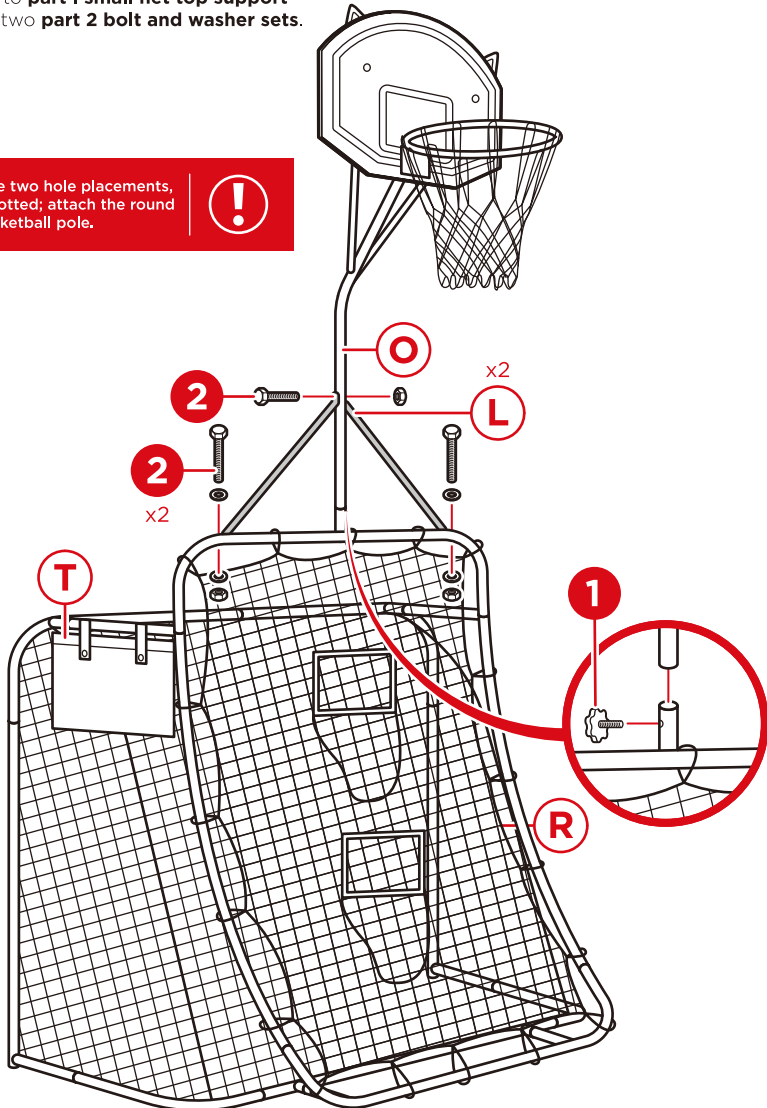

Earn points while you shop. Join today!

bestchoiceproducts
rewards

Join | Earn | Redeem

Give your friends 15% off their first order! For each successful referral you'll receive 100 points.

bestchoiceproducts.com



HELP CENTER



Question about your product? We're here to help. Visit us at:

help.bestchoiceproducts.com



Chat Support



Product Inquiry



Orders FAQ



Product Assembly



Returns & Refunds

PRODUCT WARRANTY INFORMATION

All items can be returned for any reason within 60 days of the receipt and will receive a full refund as long as the item is returned in its original product packaging and all accessories from its original shipment are included. All returned items will receive a full refund back to the original payment method. All returned items will not be charged a re-stocking fee.

All returned items require an RA (Return Authorization) number, which can only be provided by a Best Choice Products Customer Service Representative when the return request is submitted. Items received without an RA may not be accepted or may increase your return processing time. Once an item has been received by Best Choice Products, refunds or replacements will be processed within 5 business days.

All returns must be shipped back to the Best Choice Products Return Center at the customer's expense. If the reason for return is a result of an error by Best Choice Products then Best Choice Products will provide a pre-paid shipping label via email. Boxes for return shipping will not be provided by Best Choice Products, and is the customer's responsibility to either use the original shipping boxes or purchase new boxes.

Pictures may be required for some returns to ensure an item is not damaged prior to its return. Items returned are not considered undamaged until they are received by Best Choice Products and verified as such. All damages to items are the customer's responsibility until the item has been received by and acknowledge by Best Choice Products as undamaged.



WARNING

Manufacturer and seller expressly disclaim any and all liability for personal injury, property damage or loss, whether direct, indirect, or incidental, resulting from the incorrect attachment, improper use, inadequate maintenance, unapproved modification, or neglect of this product.