



Designer Collection Tubs  
Model # 226

**Andrea® 26**  
**54" x 30" x 14.75"**

**GENERAL SPECIFICATIONS:**

- Material** - Acrylic
- Installation** - Drop-in or Undermount
- Plumbed Weight** - 95 lbs / 43 kg
- Soaker Weight** - 65 lbs / 29 kg
- Average Fill** - 16 gal to above jet level
- Maximum Fill** - 32 gal to overflow

*NOTE: Filling this tub to the maximum may require an above average size or dedicated water heater.*

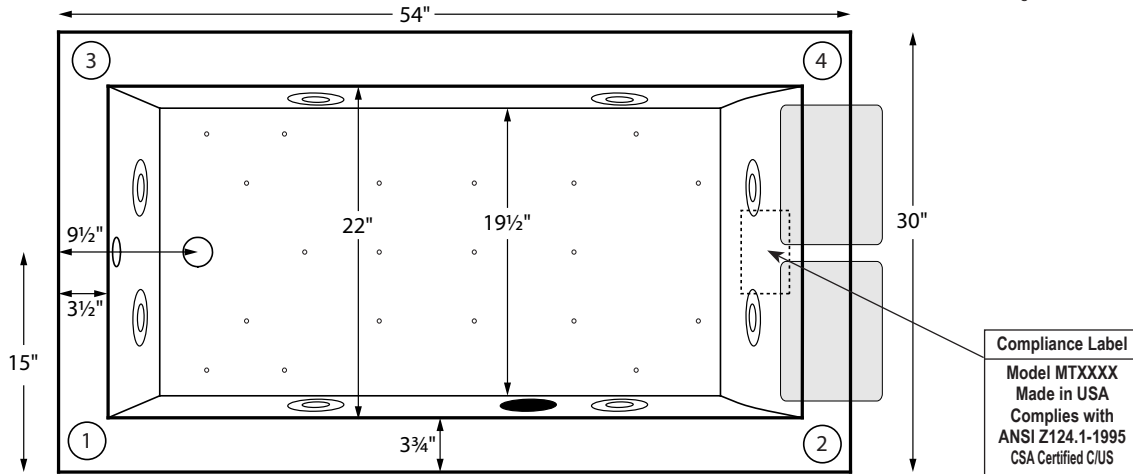

**Compliance Label**  
Model MTXXXX  
Made in USA  
Complies with  
ANSI Z124.1-1995  
CSA Certified CIUS

Numbered areas on tub deck represent possible locations to install cleaning systems, faucets and other fixtures.

**Pump extends out approximately 3" to 4" beyond tub deck.**  
Shown with Air Massage and Ultra Whirlpool Package.

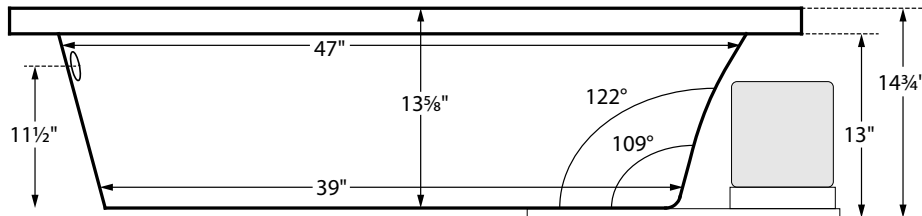

**IMPORTANT:**  
Air baths and tubs with a pre-levleled foam base or frame system add 2-3" to overall tub height.

ELECTRICAL COMPONENTS & SPECIFICATIONS		
Required Electrical Service - 110 Volt		
Hydrotherapy Package	Components Included	GFCI
Standard Whirlpool	2-bhp pump	1-15 amp
Ultra Whirlpool	2 2-bhp pumps, inline heater	2-20 amp
Air Massage	heated blower	1-15 amp
Air Massage Elite	heated blower, chromatherapy	1-15 amp
Air Massage with Standard Whirlpool	2-bhp pump, heated blower	2-15 amp
Air Massage with Ultra Whirlpool	2 2-bhp pumps, inline heater, heated blower	2-20 amp
Air Massage Elite with Standard Whirlpool	2-bhp pump, heated blower, chromatherapy	2-15 amp
Air Massage Elite with Ultra Whirlpool	2 2-bhp pumps, inline heater, heated blower, chromatherapy	2-20 amp

*For electrical requirements of tub options, see specific options specs*  
CSA Certified C/US; ANSI Z124.1 for plastic tubs and ANSI 112.19.7 for whirlpool components.

**IMPORTANT ORDERING & INSTALLATION INFORMATION:**

- Before ordering or installing, please consider future access to equipment.
- Add bedding compound to fully level and support bottom of tub.
- Tubs equipped with an air bath or a pre-levleled foam base are designed to rest on the floor *without* bedding compound, provided the floor is level.
- **Overall tub height is increased by approx. 2-3" when tub is equipped with any air bath package or when pre-levleled foam base or frame system is ordered.**
- Radiance placed on floor locations will affect placement of air jets.
- Please measure tub **on-site** before building tub decking.
- If you are planning to use a glass enclosure, MTI must be advised when ordering for possible relocation of controls.
- Suction and control locations may vary.
- Specifications and configurations are subject to change without notice.
- Measurements are ±1/2" and are subject to change without notice.
- Measurements herein supersede all others published prior to publication date shown below.













See the "Designer Collection Tubs Installation & Operation Manual" included with tub delivery or go to [mtibaths.com/support/installation\\_operation/manuals](http://mtibaths.com/support/installation_operation/manuals) for all the information necessary to install and operate the tub.

MTI's Customer Service Department is available Monday-Friday 8am-6pm EST at 800-783-8827 or [customerservice@mtibaths.com](mailto:customerservice@mtibaths.com) to answer any questions pertaining to ordering or installation.



## Packages and Pricing

For more information on any of the following packages, please visit: [mtibaths.com/therapies-for-wellness/](http://mtibaths.com/therapies-for-wellness/)

Hydrotherapy Packages	Package Contents	Part #	MSRP
 Soaker	Soaking bath - no jets	S226-DI	\$1,960
		S226-UM	
 Stream Bath	6 side vents, 2 end vents, 1-bhp pump	SM226-DI	\$3,810
		SM226-UM	
 Air Massage	20 air jets, heated air blower, Aromatherapy, pre-leveled foam base (increases overall height 2-3")	AST226-DI	\$4,775
		AST226-UM	
 Air Massage Elite	30 air jets, heated air blower, Aromatherapy, Chromatherapy LED lighting, Spa Mode, pre-leveled foam base (increases overall height 2-3")	AE226-DI	\$6,505
		AE226-UM	
 Stream Bath with Air Massage	6 side vents, 2 end vents, 1-bhp pump, 20 air jets, heated air blower, Aromatherapy, pre-leveled foam base (increases overall height 2-3")	ASTSM226-DI	\$6,625
		ASTSM226-UM	
 Stream Bath with Air Massage Elite	6 side vents, 2 end vents, 1-bhp pump, 30 air jets, heated air blower, Aromatherapy, Chromatherapy LED lighting, Spa Mode, pre-leveled foam base (increases overall height 2-3")	AESM226-DI	\$8,355
		AESM226-UM	
 Standard Whirlpool	6 point-massage jets, 2-bhp pump	P226-DI	\$4,080
		P226-UM	
 Ultra Whirlpool	8 point-massage jets, 2-bhp pump, inline heater, Ozone	P226U-DI	\$5,190
		P226U-UM	
 Air Massage with Standard Whirlpool	6 point-massage jets, 2-bhp pump, 20 air jets, heated air blower, Aromatherapy, pre-leveled foam base (increases overall height 2-3")	AW226-DI	\$7,030
		AW226-UM	
 Air Massage with Ultra Whirlpool	8 point-massage jets, 2-bhp pump, inline heater, 20 air jets, heated air blower, Aromatherapy, Ozone, pre-leveled foam base (increases overall height 2-3")	AU226-DI	\$8,160
		AU226-UM	
 Air Massage Elite with Standard Whirlpool	6 point-massage jets, 2-bhp pump, 30 air jets, heated air blower, Aromatherapy, Chromatherapy LED lighting, Spa Mode, pre-leveled foam base (increases overall height 2-3")	AEAP226-DI	\$9,100
		AEAP226-UM	
 Air Massage Elite with Ultra Whirlpool	8 point-massage jets, 2-bhp pump, inline heater, 30 air jets, heated air blower, Aromatherapy, Ozone, Chromatherapy LED lighting, Spa Mode, pre-leveled foam base (increases overall height 2-3")	AEAP226U-DI	\$10,125
		AEAP226U-UM	

**Lead Time** - Soakers, Stream Bath and Whirlpool Packages - 5 business days  
Air Baths and Combo Packages - 7 business days

**NOTES:** • Aromatherapy is eliminated for undermount applications  
• Air Baths, Pre-Leveled Foam Base or Frame Systems increase overall height by 2-3".

### RECOMMENDED SENSORY THERAPIES

SEE NEXT PAGE FOR AN OVERVIEW OF AVAILABLE OPTIONS.



**Chromatherapy**  
Underwater lighting is provided by digitally controlled LEDs. Different colors are thought to have different therapeutic effects.

LE - \$610



**Audiotherapy**  
Stereo H<sub>2</sub>O lets you "feel" the music through the bath water. Available with Bluetooth system or transducers with leads to connect to an external system.

STEREOH202 - \$1,135  
STEREOBT - \$1,235



**Thermotherapy**  
Radiance uses integrated radiant heat to warm the backrest for neck, shoulders and back. Inline heaters maintain bath water temperature.

RAD100 - \$1,080  
HTISOAK - \$750



**Microbubbles**  
For wellness and beauty, billions of the tiniest air bubbles saturate the water with dissolved oxygen to moisturize and soften the skin. Available for soakers and air baths.

MICRO - \$1,745



## Options and Pricing

For more information on any of the following options, please visit: [mtibaths.com/tub-options/](http://mtibaths.com/tub-options/)

### Premium Options

NOTE: part codes for all options listed in parenthesis.

**Microbubbles** - Available on Soakers and Air Baths only  
(MICRO) **\$1,745**  
System components may extend up to 5" beyond perimeter of the tub.

**Radiance** - integrated tub shell heating system  
(RAD100) **\$1,080**

**Chromatherapy** - Included in some hydrotherapy packages  
underwater LED lighting (LE) **\$610**

**Stereo H<sub>2</sub>O - Standard System** - includes 4 integrated audio transducers with leads to connect to an external audio source  
(STEREOH202) **\$1,135**  
**Bluetooth System** - integrated Bluetooth system allows you to directly connect to an applicable device  
(STEREOBT) **\$1,235**

### Standard Options

**Standard Colors:** White (CWH), Bone (CBN), Biscuit (CBS)  
**Color Upgrade:** (COL2) **\$500**, please call for availability of special colors

**Quick Ship** - reduces lead time - please call for availability  
(QSPRI) **\$380**

**Textured, Slip-Resistant Bottom** - meets ASTM F462-1994  
(TXBTM) **\$75**

**Virtual Spout** - high-flow integrated tub filler  
(FPMJ) **\$310**

**Low-Profile Rim** - reduces rim height to 1"  
(LPR) **\$125**

**Inline Heater** - included in some hydrotherapy packages  
For whirlpools or Stream Bath (HTI) **\$545**  
Uses existing pump  
Soaker or Air Baths (HTISOAK) **\$750**  
Includes a recirculating pump.

### Installation Aids

**Tile Flange** must specify flange location(s) on order  
Note: Tile flange not available with Low-Profile Rim option.  
Factory-Installed on 3 sides - rigid ABS (TFK3) **\$190**  
Field Install Kit - includes rigid ABS & adhesive (TFKNI) **\$175**

**Pre-Leveled Foam Base** - for soaker or whirlpools (PLFOAM) **\$175**

**Pre-Leveled Frame and Foam Base (PLF)** **\$525**

**Pre-Leveled Frame and Foam Base with Skirting**  
See skirting options pricing and specs online.

### Accessories & Hardware for All Packages

**Drain Kits** - other finishes also available

#### Toe-Tap with Slim-Line Integrated Overflow

Choose from: Chrome (SLOT), Brushed Nickel (SLOTBN),  
Polished Nickel (SLOTPN) or White (SLOTWH) **\$390**

#### Toe-Tap with Rectangular Overflow -

Chrome (WOTRC) **\$285**  
Brushed Nickel (WOTRBN) **\$290**  
White (WOTRW) **\$290**

#### Toe-Tap with Round Overflow -

Chrome (WOTTC) **\$285**  
Brushed Nickel (WOTTBN) **\$290**  
Polished Nickel (WOTTPN) **\$340**

#### Cable Driven -

Chrome (WOCD) **\$315**  
Brushed Nickel (WOCDBN) **\$385**  
Polished Nickel (WOCDPN) **\$515**  
Oil-Rubbed Bronze (WOCBOR) **\$515**

#### Lift & Turn -Chrome (WOC) **\$125**

Brushed Nickel (WOBN) **\$225**

#### Grab Bars - 9" Curved, set of 2

Acrylic - color-matched with tub  
standard colors only (GB) **\$300**  
Metal - Chrome (GBMCC), Brushed Nickel (GBMCBN) **\$330**

**Pillows** - from **\$125** See pillows pricing and specs online.

**Teak Tub Tray** - Slatted (TK-TRAY1) or Solid (TK-TRAY2) **\$415**

**Teak Bath Mat** (TK-MAT3018) **\$430** custom sizes also available

### Accessories & Cleaning Systems for Whirlpool Packages

**Trim Kits** - must be ordered at time of purchase; other finishes available

Standard Whirlpool - Chrome (TRC) **\$235**; Brushed Nickel (TRBN) **\$595**  
Ultra Whirlpool - Chrome (TRCU) **\$320**; Brushed Nickel (TRBNU) **\$815**

**Pump Upgrade** - 3-bhp (PUMP3) **\$245**

**Additional Jet Options** See jet options pricing and specs online.

#### Whirlpool Cleaning Systems -

Fill-Flush (FFSO) **\$590**; Simple Touch (FFE) **\$710**

**Ozonator** - bath water purification system (OZONE) **\$535**

