

Features

- Two-piece design
- Elongated bowl offers added room and comfort
- Skirted trapway simplifies cleaning
- Revolution 360® flushing technology generates a forceful swirling motion to keep the bowl clean longer
- Comfort Height® feature offers chair-height seating that makes sitting down and standing up easier for most adults
- 1.28 gpf (4.8 lpf)
- 2-1/8" (54 mm) glazed trapway
- CleanCoat™ surface treatment inhibits the growth of water scale and mineral stains for improved ease of cleaning
- Alternative options available: Betello with ContinuousClean - K-20198
- AquaPiston® canister optimizes the flow out of the tank, harnessing gravity and the natural, powerful reducing cascade of water to increase the power and effectiveness of the flush
- Easy-to-flush canister design requires less force to actuate than a 3" (76 mm) flapper, and has 90% less exposed seal material which resists conditions that cause wear, tear, shrinkage and swelling
- Patented ReadyLock® installation system, a simple solution for skirted toilets, saves time, hassle, and eliminates the need to drill into the floor for standard 12" (305 mm) rough-in
- Left-hand trip lever

Installation

- Standard 12" (305 mm) rough-in
- 10" and 14" (254 mm and 356 mm) rough-in kits also available
- Seat and supply line sold separately

Recommended Products/Accessories

K-5383 10" rough-in full skirt trap and attachment system
K-5381 14" rough-in full skirt trap and attachment system
K-26801 Impro® ReadyLatch® Quiet-Close™ elongated toilet seat

Included Components

K-20148 Elongated toilet bowl with skirted trapway
K-20203 Toilet tank, 1.28 gpf

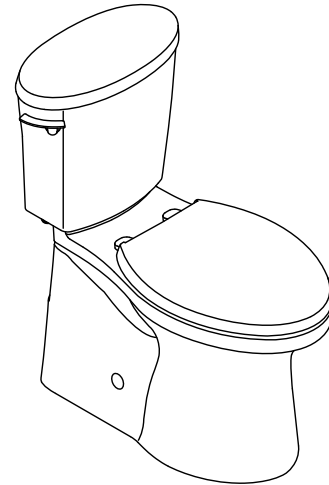

ADA **CSA B651** **OBC**

Codes/Standards





ASME A112.19.2/CSA B45.1
DOE - Energy Policy Act 1992
EPA WaterSense®
California Energy Commission (CEC)
ADA
ICC/ANSI A117.1
CSA B651
OBC

KOHLER® Toilets and Seats Limited Warranty

See website for detailed warranty information.

Available Colors/Finishes

Color tiles intended for reference only.

Color	Code	Description
	0	White
	96	Biscuit
	NY	Dune
	95	Ice™ Grey
	7	Black Black™

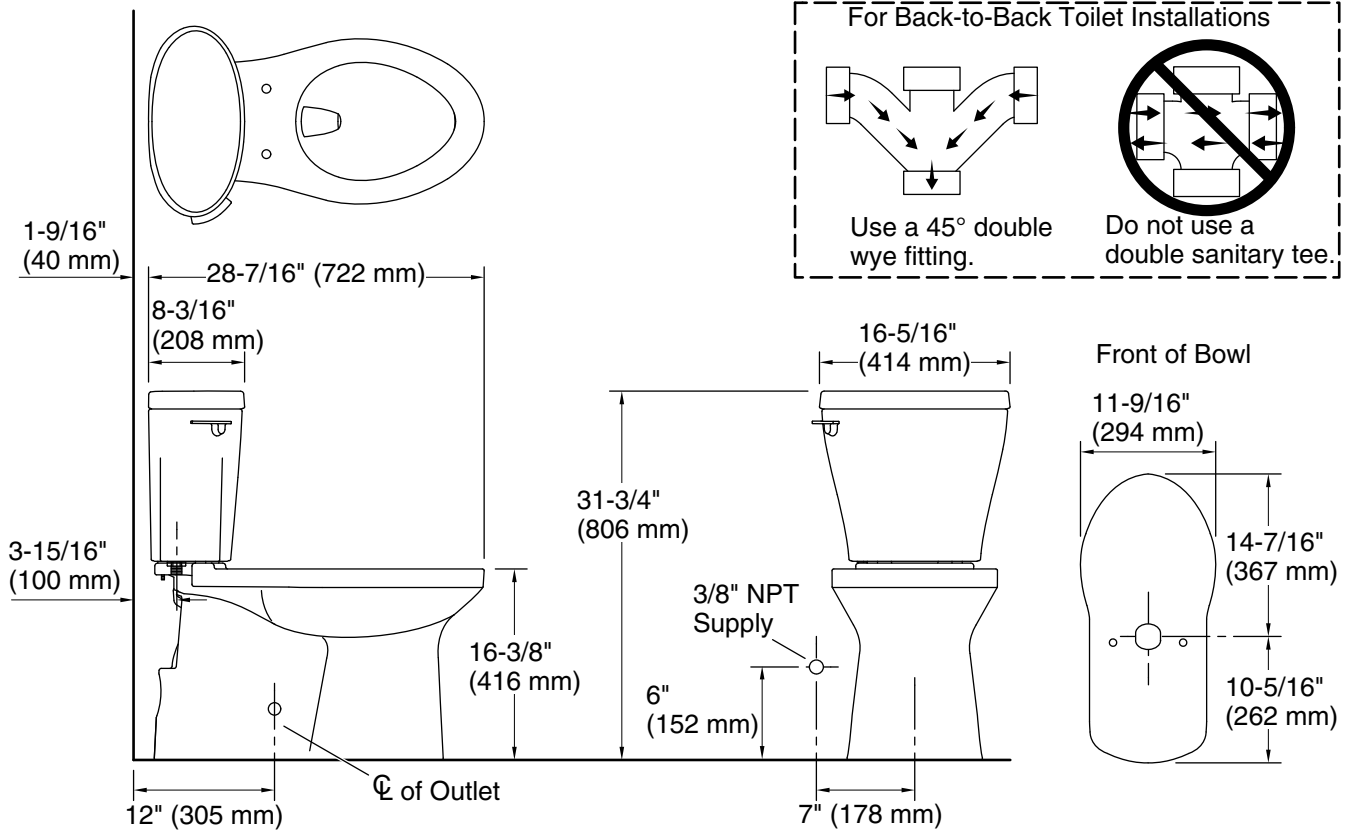

Technical Information

All product dimensions are nominal.

Toilet type:	Floor-mount
Waste Outlet:	Floor
Bowl shape:	Elongated
Flush type:	Revolution 360, AquaPiston
Trap passageway:	2-1/8" (54 mm)
Water surface size:	9-3/8" x 7-3/16" (238 mm x 183 mm)
Rim to water surface:	6-5/16" (160 mm)
Rough-in:	12" (305 mm)

Fixture Supply Requirements

Min static pressure:	20 psi (137.9 kPa)
Max static pressure:	80 psi (551.6 kPa)
Min flowing pressure:	15 psi (103.4 kPa)
Min flow rate:	1 gpm (3.8 lpm)

Notes

Install this product according to the installation instructions.

For back-to-back toilet installations: Use only a 45° double wye fitting.

ADA, OBC, CSA B651 compliant when installed to the specific requirements of these regulations.

Plumbing codes may require elongated toilets and elongated, open-front seats in public bathrooms.

Accessibility standards may require controls to be located on the open side of the toilet.