

MODELS:

IP060S (REB-B1800FF-US)

IP120S (REB-B3500FF-US)

IP090S (REB-B2600FF-US)

IP150S (REB-B4400FF-US)

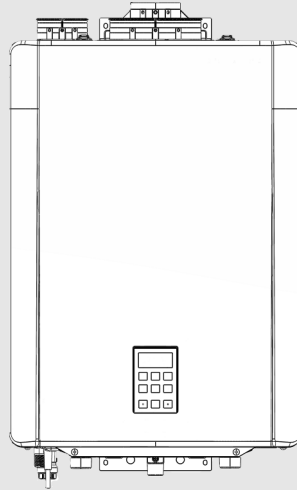

CSA/ANSI Z21.13 CSA 4.9

I-Series Plus Condensing Heat-Only Boiler

Installation and Operation Manual

Rinnai



**WARNING**

If the information in these instructions are not followed exactly, a fire or explosion may result causing property damage, personal injury, or loss of life.

- Do not store or use gasoline or other flammable vapors and liquids in the vicinity of this or any other appliance.
- WHAT TO DO IF YOU SMELL GAS
 - Do not try to light any appliance.
 - Do not touch any electrical switch; do not use any phone in your building.
 - Immediately call your gas supplier from a neighbor’s phone. Follow the gas supplier’s instructions.
 - If you cannot reach your gas supplier, call the fire department.
- Installation and service must be performed by a qualified installer, service agency or the gas supplier.

Contents

1 Welcome.....	4
1.1 To the Installer	4
1.2 To the Consumer	4
1.3 Acronyms and Abbreviations	4
2. Safety	5
2.1 Safety Symbols	5
2.2 Safety Precautions	5
3. About the Boiler	7
3.1 Front View	7
3.2 Bottom View	7
3.3 Components.....	9
3.4 Specifications	10
3.5 Dimensions.....	11
3.6 Accessories.....	13
4. Installation	14
4.1 Installation Guidelines	14
4.2 What You’ll Need	15
4.3 Items Included.....	16
4.4 Choose an Installation Location	17
4.5 Mount the Boiler to the Wall	20
4.6 Fill the Condensate Collector	21
5. Venting.....	22
5.1 Guidelines	22
5.2 Venting Installation Sequence	23
5.3 Termination Considerations.....	23
5.4 PVC Venting Safety Switch	24
5.5 Venting Options	25
6. Gas Supply	47
6.1 Connect the Gas Supply	47
6.2 Gas Operating Instructions	48
6.3 Gas Pipe Sizing Reference Tables.....	49
7. CH System Piping	51
7.1 Guidelines	51
7.2 Instructions	51
7.3 Common CH Components.....	52
7.4 Piping Diagram for a Basic CH System (With Hydraulic Separation)	54
7.5 Hydraulic Separation.....	55
7.6 Connect the Pressure Relief Valves	58
7.7 Connect the Condensate Drain Line	59
7.8 Condensate Pump Safety Switch Wiring.....	60

8. DHW System Piping with Indirect Tank	62
8.1 Guidelines	62
8.2 Indirect Tank Control Options.....	62
8.3 Indirect Tank Electrical Connections.....	63
8.4 Simultaneous CH and DHW Operation	65
8.5 Indirect Tank Parameter Settings.....	66
8.6 Piping Diagram for a Basic DHW Installation	67
9. Power Supply	68
9.1 Guidelines	68
9.2 Electrical Connections.....	69
9.3 Post-Power Supply Connection Checklist	70
9.4 Initial Settings.....	71
10. Commissioning	74
10.1 Safety Precautions	74
10.2 Filling Process.....	74
10.3 Deaeration Process	75
11. Post-Installation Checklist	77
12. Operation	79
12.1 Start-Up Information	79
12.2 Control Panel	80
12.3 Basic Operation Settings	82
12.4 Parameter Settings.....	91
12.5 Outdoor Reset Control.....	99
12.6 Air Handler Control	105
12.7 Bluetooth Low Energy (BLE) and App Instructions	106
12.8 Diagnostic Codes.....	107
12.9 Forced Hi/Low Fire Modes.....	112
13. Maintenance	113
13.1 Owner Maintenance	113
13.2 Licensed Professional Maintenance	114
13.3 Test the Ignition Safety Shutoff Device.....	117
14. Appendices	118
14.1 Approved Cleaners, Inhibitors and Antifreezes	118
14.2 Flush the CH Plumbing System	119
14.3 System Application Examples	122
14.4 Gas Conversion	126
14.5 Wiring Diagram	129
14.6 Ladder Diagram.....	130
14.7 CH Pressure Drop and Flow Curve	131
14.8 Remove a Boiler from a Common Vent System.....	132
14.9 Massachusetts State Gas Regulations.....	133
14.10 Federal Communication Commission (FCC) Interference Statement.....	134
14.11 Industry Canada Statement	135
14.12 Warranty.....	136

1. Welcome

Thank you for purchasing a Rinnai I-Series Plus Condensing Boiler. Before installing and operating this boiler, be sure to read these instructions completely and carefully to familiarize yourself with the boiler's features and functionality.

1.1 To The Installer

- A trained and qualified professional must install the boiler, inspect it, and leak test it before use. The warranty will be voided due to any improper installation.
- The trained and qualified professional should have skills such as:
 - Gas line sizing
 - Connecting gas lines, water lines, valves, and electricity
 - Knowledge of applicable national, state, and local codes
 - Installing venting through a wall or roof
 - Training in installation of condensing boilers. Training on Rinnai I-Series Plus Condensing Boilers is accessible at rinnaiapro.myabsorb.com.
- Read all instructions in this manual before installing the boiler. The boiler must be installed according to the exact instructions in this manual.
- Proper installation is the responsibility of the installer.
- When installation is complete, leave this manual with the boiler or give the manual directly to the consumer.

1.2 To The Consumer

- You must read the entire manual to properly operate the boiler.
- Keep this manual for future reference.
- As when using any appliance generating heat, there are certain safety precautions you should follow. See section "2.2 Safety Precautions" for detailed safety precautions.
- Be sure your boiler is installed by a licensed installer.
- If installing in the state of Massachusetts, read section "14.9 Massachusetts State Gas Regulations" in this manual.

1.3 Acronyms and Abbreviations

Following is a list of common acronyms and abbreviations used in this manual:

Table 1

ANSI	American National Standards Institute
Btu	British Thermal Unit
CH	Central Heating
DHW	Domestic Hot Water
GPM	Gallons per minute
LP	Liquid Propane
LWCO	Low Water Cut Off
NG	Natural Gas
PP	Polypropylene
PRV	Pressure Relief Valve
PSI	Pounds per square inch
W.C.	Inches water column

2. Safety

WARNING

- If the information in these instructions is not followed exactly, a fire or explosion may result causing property damage, personal injury, or death.
- Do not store or use gasoline or other flammable vapors and liquids in the vicinity of this or any other appliance.
- WHAT TO DO IF YOU SMELL GAS:
 - Do not try to light any appliance.
 - Do not touch any electrical switch; do not use any phone in your building.
 - Immediately call your gas supplier from a neighbor's phone. Follow the gas supplier's instructions.
 - If you cannot reach your gas supplier, call the fire department.
- Installation and service must be performed by a qualified installer, service agency or the gas supplier.
- The warning signs in this manual are here to prevent injury to you and others. Please follow them explicitly.

2.1 Safety Symbols

This manual contains the following important safety symbols. Always read and obey all safety messages.



Safety alert symbol. Alerts you to potential hazards that can kill or hurt you and others.

DANGER

Indicates an imminently hazardous situation which, if not avoided, will result in personal injury or death.

WARNING

Indicates a potentially hazardous situation which, if not avoided, could result in personal injury or death.

CAUTION

Indicates a potentially hazardous situation which, if not avoided, could result in minor or moderate injury. It may also be used to alert against unsafe practices.

2.2 Safety Precautions

The following precautions apply to the installer and consumer. Read and follow all instructions in this section.

- Before operating, smell all around the appliance area for gas. Be sure to smell next to the floor because some gas is heavier than air and will settle on the floor.
- Keep the area around the appliance clear and free from combustible materials, gasoline, and other flammable vapors and liquids.
- Do not store or use gasoline or other flammable vapors and liquids in the vicinity of this or any other appliance.
- Combustible construction refers to adjacent walls and ceiling and should not be confused with combustible or flammable products and materials. Combustible and/or flammable products and materials should never be stored in the vicinity of this or any gas appliance.
- Always check the water temperature before entering a shower or bath.

- Do not use this appliance if any part has been under water. Immediately call a licensed professional to inspect the appliance and replace any part of the control system and any manual gas control valve which has been under water.
 - Do not use substitute materials. Use only parts certified for the appliance.
 - Should overheating occur or the gas supply fail to shut off, turn off the manual gas control valve to the appliance.
 - It is strongly recommended that you use a trained and qualified professional who has attended a Rinnai installation training class to adjust parameter settings.
 - Do not use an extension cord or adapter plug with this appliance.
 - Any alteration to the appliance or its controls can be dangerous and will void the warranty.
 - To protect yourself from harm, before performing maintenance:
 - Turn off the electrical power supply by unplugging the power cord or by turning off the electricity at the circuit breaker. (The boiler controller does not control the electrical power.)
 - Turn off the gas at the gas control, usually located immediately below the boiler.
 - Turn off the incoming water supply. This can be done at the isolation valve immediately below the boiler for the domestic hot water. Turning off the water for the central heating system is done at the boiler system filling station shut-off valve or the main water supply to the building.
 - Use only your hand to turn the manual gas control valve. Never use tools. If the manual gas control valve will not turn by hand, do not try to repair it; call a trained and qualified professional. Force or attempted repair may result in a fire or explosion.
 - Proper venting is required for the safe operation of this appliance. Failure to properly vent this appliance can result in death, personal injury and/or property damage.
- Flammable liquids such as cleaning solvents, aerosols, paint thinners, adhesives, gasoline and propane must be handled and stored with extreme care. These flammable liquids emit flammable vapors and when exposed to an ignition source can result in a fire hazard or explosion. Flammable liquids should not be used or stored in the vicinity of this or any other gas appliance.
 - DO NOT operate the boiler without the front panel installed. The front panel should only be removed for service/ maintenance or replacing internal components.
 - BURN HAZARD. Hot exhaust and vent may cause serious burns. Keep away from the boiler. Keep small children and animals away from the boiler.
 - Heating supply, return and domestic hot water outlet pipes leaving the boiler can be hot to touch.
 - Install the vent system per local and national codes.
 - Do not install this boiler above 10,200 ft (3,109 m).
 - Do not obstruct combustion air to the boiler.
 - The installer must verify that at least one carbon monoxide alarm has been installed within a residential living space or home following the alarm manufacturer's instructions and applicable local codes before putting the appliance into operation. Rinnai recommends that every home have a carbon monoxide (CO) alarm in the hallway near bedrooms in each sleeping area. Check batteries monthly and replace them annually.
 - Failure to properly vent this appliance can result in death, personal injury and/or property damage.

3. About the Boiler

- Topics in this section**
- Front View
 - Bottom View
 - Components
 - Specifications
 - Dimensions
 - Accessories

3.1 Front View

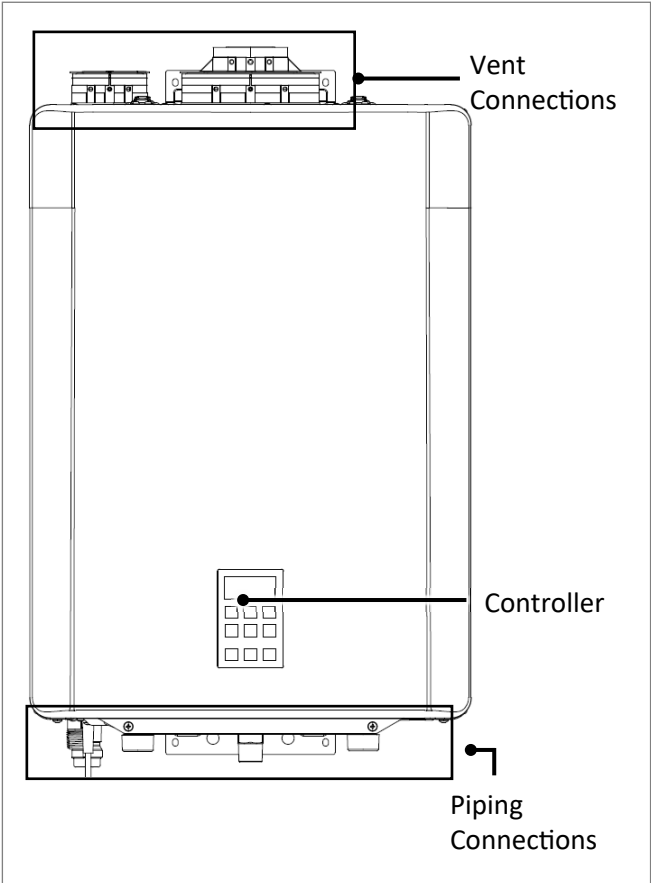

Figure 1: Front View

3.2 Bottom View

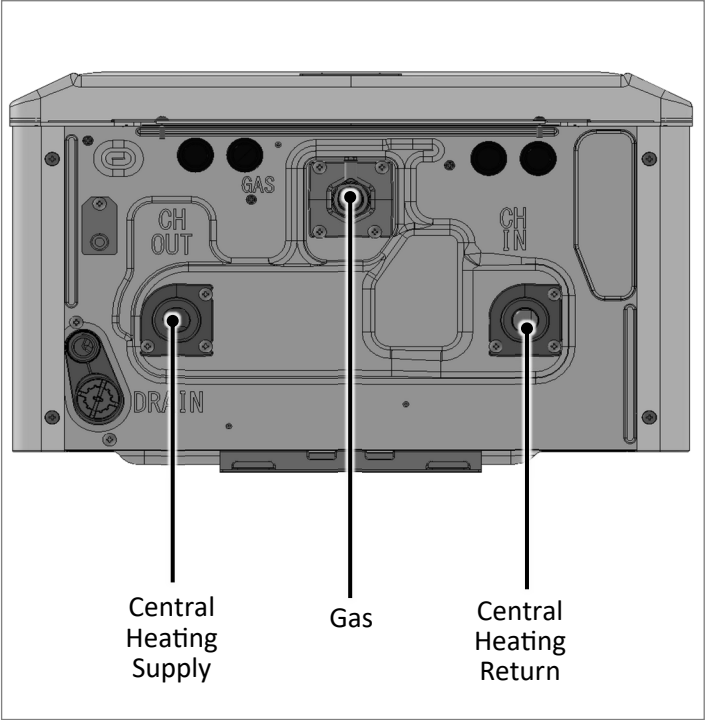

Figure 2: Bottom View

3.2.1 Bottom View Piping

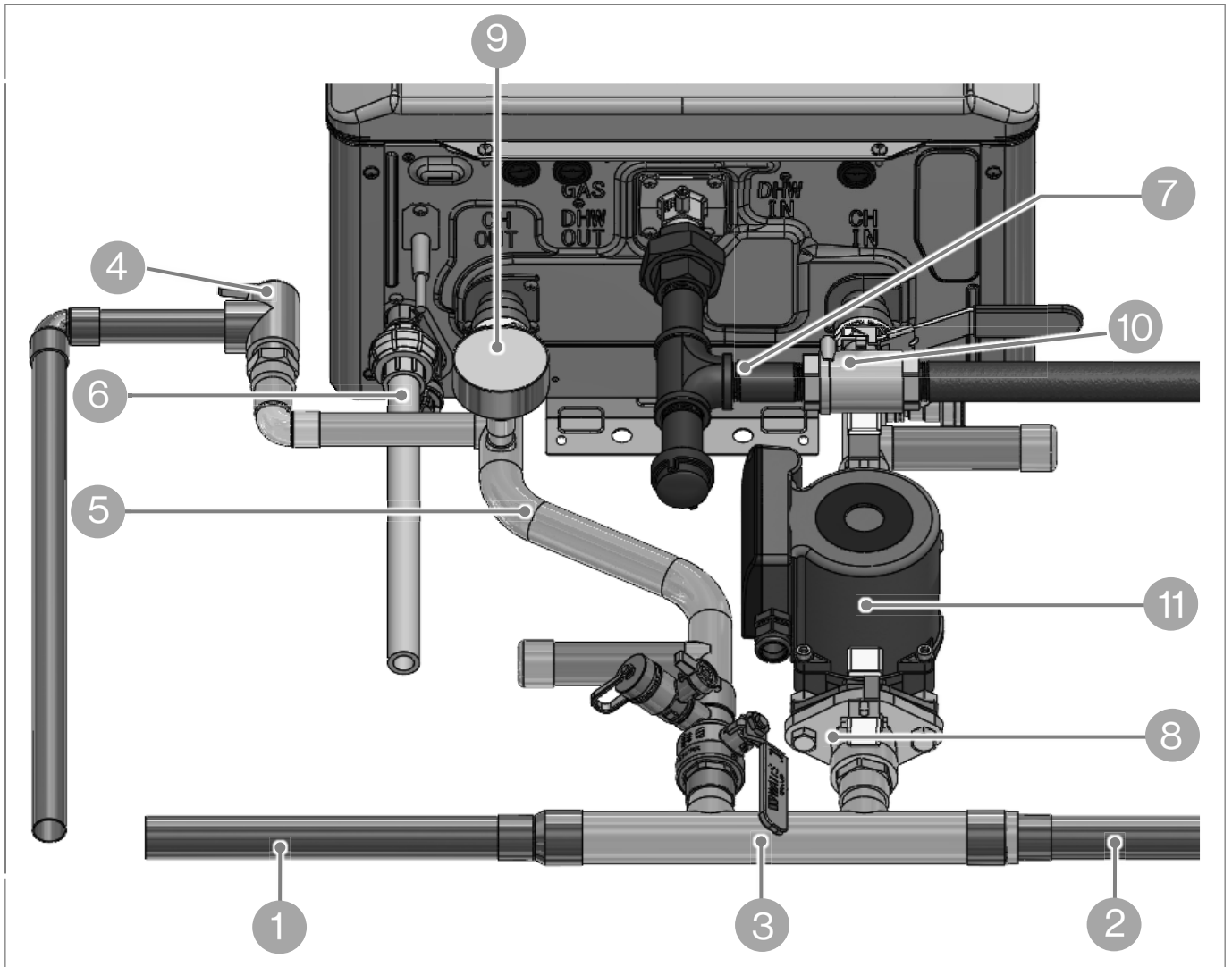

Figure 3: Bottom View Piping

All items are field-supplied unless otherwise noted.

- | | | | |
|---|---|----|--------------------|
| 1 | Supply to CH System | 6 | Condensate Drain |
| 2 | Return from CH System | 7 | Gas Supply |
| 3 | Primary-Secondary Heating Kit | 8 | CH Return |
| 4 | CH Pressure Relief Valve (supplied with boiler) | 9 | CH Pressure Gauge |
| 5 | CH Supply | 10 | Gas Shut Off Valve |
| | | 11 | Boiler Pump |

3.3 Components

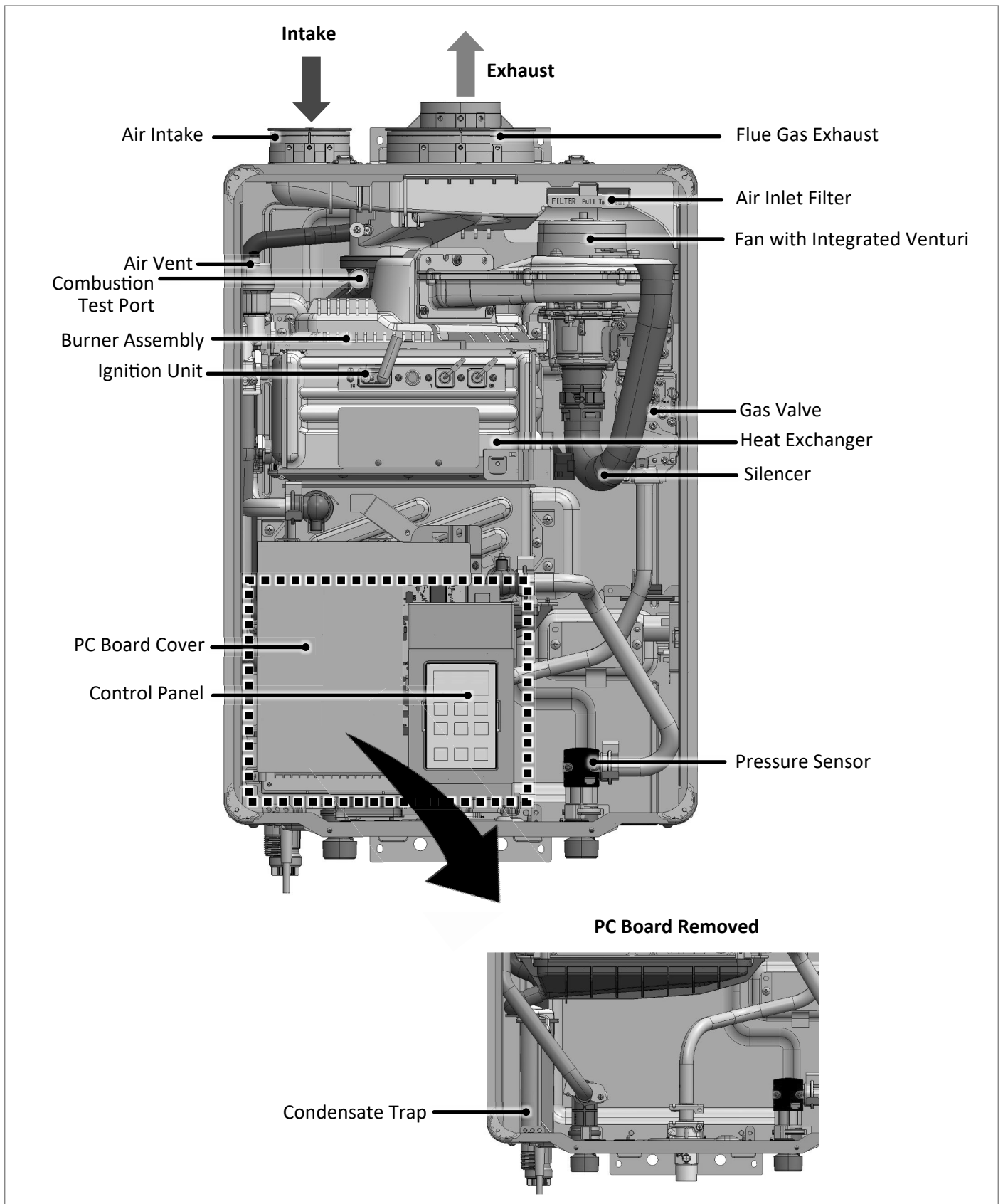

Figure 4: Components

3.4 Specifications

Table 2

Model		IP060S	IP090S	IP120S	IP150S
Weight		62.6 lb (28.4 kg)		64.8 lb (29.4 kg)	
Appliance Type		Wall-Mounted, Gas-Fired Heat-Only (Solo) boiler			
Installation Type		Indoor			
Ignition System		Direct Electronic Ignition			
Heat Exchanger Surface Area		9.3 sq ft		10.9 sq ft	
Gas Consumption (Btu/h)	Minimum	15,000			
	Maximum	60,000	90,000	120,000	150,000
Temperature Setting	CH	(Minimum - Maximum) 86°F - 180°F (30°C - 82°C)			
	Indirect Tank (DHW)	120°F - 150°F (50°C - 65°C)			
Water Content		0.75 gal		0.88 gal	
Water Pressure	CH	Minimum: 13 PSI (90 kPa) Maximum: 45 PSI (310 kPa) Recommended: 17-26 PSI (117-180 kPa)			
	Pressure Relief Valve (included with system)	30 PSI (207 kPa)			
Sound Level		40 dB(A)			42 dB(A)
Electrical Data	Normal	46 W	59 W	64 W	
	Standby	8 W			
	Max Current	14 Amps (Including external pumps and thermostats)			
	Fuse	10 Amps × 1, 4 Amps × 5			
Gas Supply Pressure ¹	Natural Gas	3.5 in. - 10.5 in. W.C. (0.87 - 2.61 kPa)			
	Propane	8.0 in. - 13.5 in. W.C. (1.99 - 3.36 kPa)			
Electric Connections		AC 120 Volts, 60 Hz			
Certifications		ANSI Z21.13, CSA 4.9, ASME			
Canada CRN		2089.9CL			

¹ Maximum gas supply pressure must not exceed the value specified by the manufacturer.

Rinnai products are continually being updated and improved; therefore, specifications are subject to change without prior notice.

3.5 Dimensions

Measurements: in. (mm)

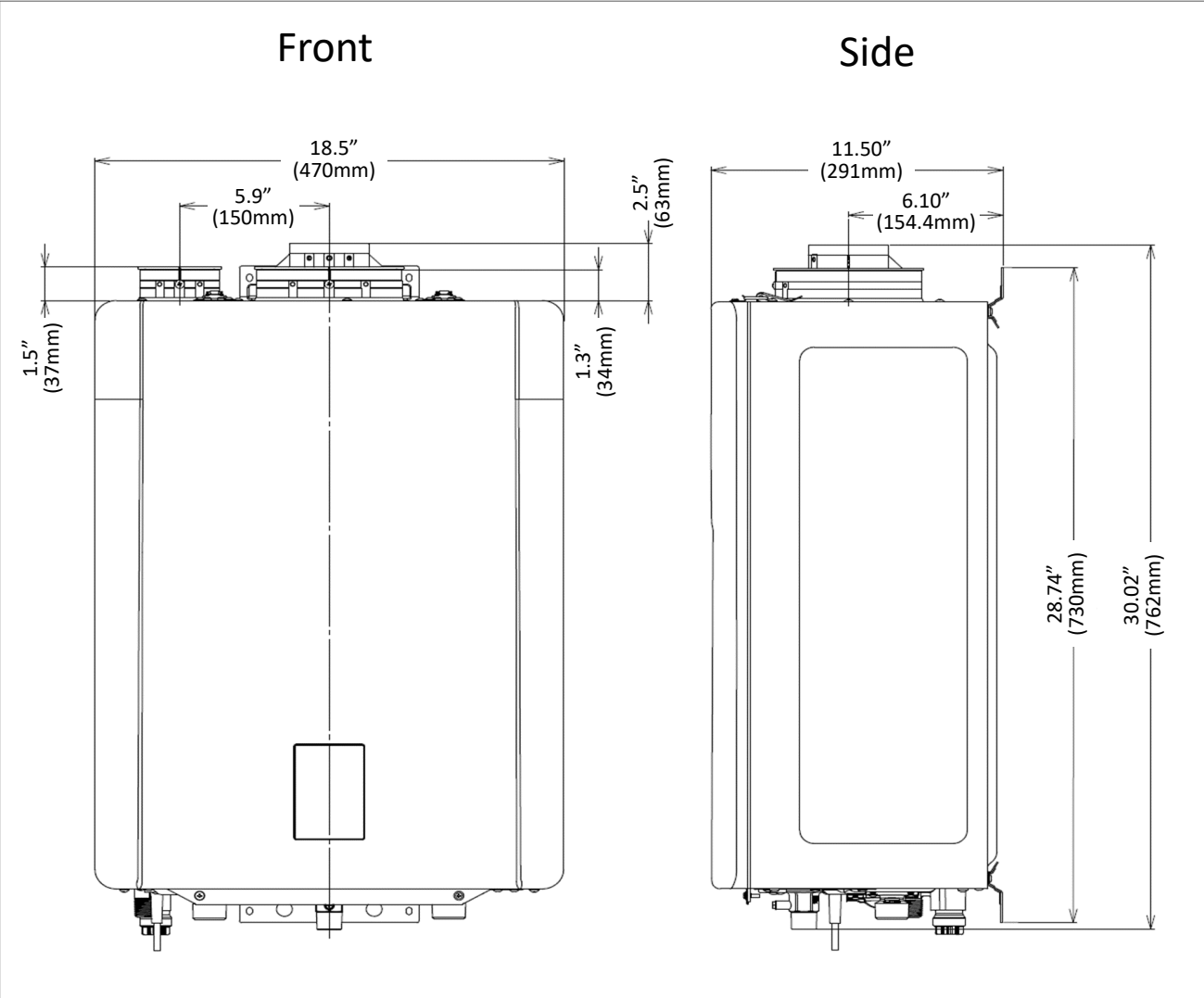

Figure 5: Dimensions

Vent Connection: 2 in. (51 mm) nominal PVC/Polypropylene or 3 in./5 in. Concentric

3.5.1 Supply Connections

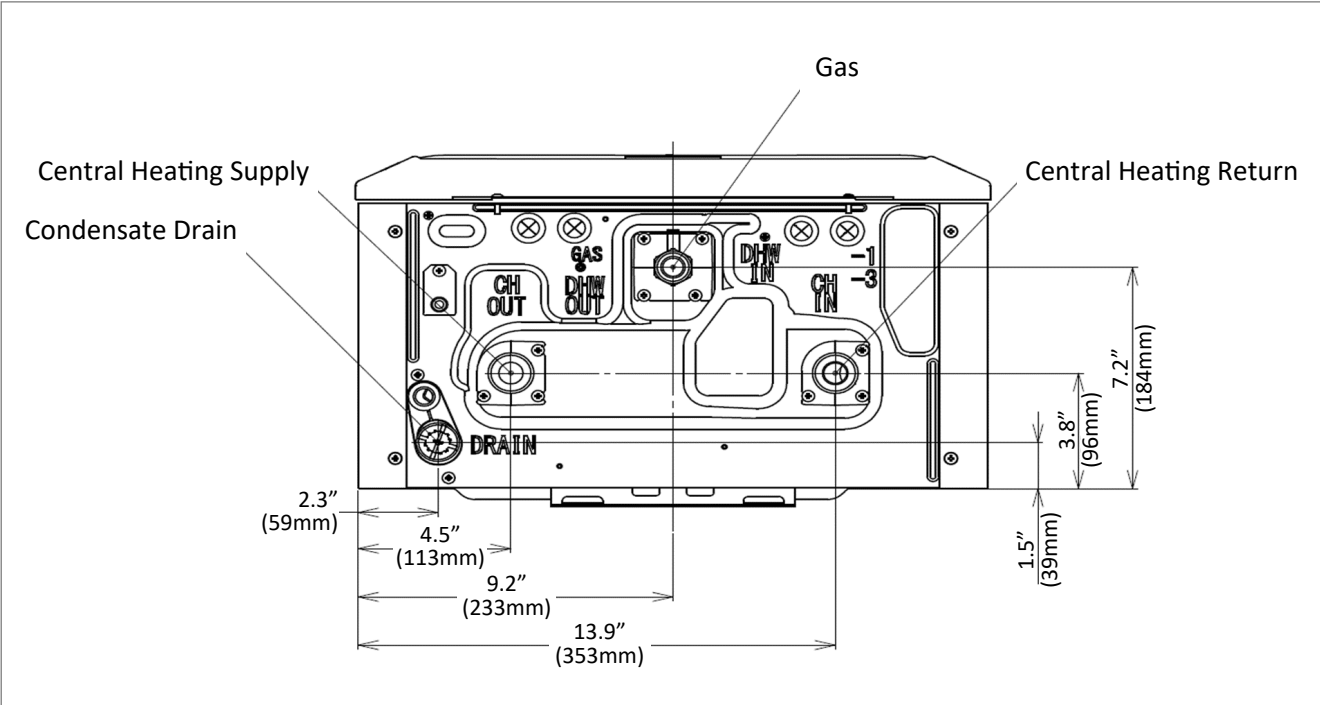

Figure 6: Supply Connections

Table 3

Connection	Connection Size
Gas	3/4 in. NPT
CH In (CH Return)	1 in. NPT
CH Out (CH Supply)	1 in. NPT
Condensate Outlet	1/2 in. NPT

3.6 Accessories

The following optional accessories are available for the Rinnai I-Series Plus Condensing Boiler.

CONDENSATE NEUTRALIZER

Part #: 804000074

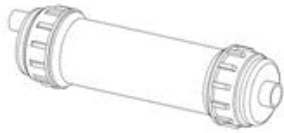

Neutralizes the condensate generated by the boiler.

SCALECUTTER

Part #: 103000038

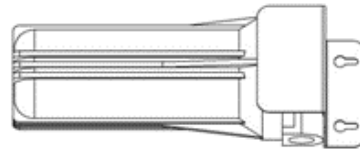

Filters and reduces the amount of scale entering the boiler allowing for greater boiler longevity.

SCALECUTTER REFILL CARTRIDGE

Part #: 103000039

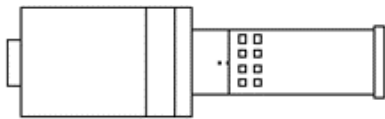

Refill cartridge for the Scale Cutter filter assembly.

PRIMARY-SECONDARY HEATING KIT

Part #: 807000213

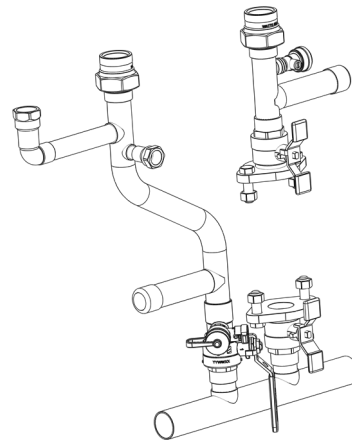

Figure 7

4. Installation

Topics in this section

- Installation Guidelines
- What You'll Need
- Items Included
- Choose an Installation Location
- Mount the Boiler to the Wall
- Fill the Condensate Collector

**THIS SECTION IS INTENDED
FOR THE INSTALLER**

4.1 Installation Guidelines







- This boiler is certified for installation in residential and commercial applications.
- This boiler is suitable for combination water heating through an indirect tank and central heating.
- The installation must conform with local codes or, in the absence of local codes, with the *National Fuel Gas Code, ANSI Z223.1/NFPA 54*, or the *Natural Gas and Propane Installation Code, CSA B149.1*. If installed in a manufactured home, the installation must conform with the *Manufactured Home Construction and Safety Standard, Title 24 CFR, Part 3280* and/or *CAN/SCA Z240 MH Series, Mobile Homes*.
- The appliance, when installed, must be electrically grounded in accordance with local codes or, in the absence of local codes, with the *National Electrical Code, ANSI/NFPA 70*, or the *Canadian Electrical Code, CSA C22.1*.
- The appliance and its main gas valve must be disconnected from the gas supply piping system during any pressure testing of that system at test pressures in excess of 1/2 PSI (3.5 kPa) (13.84 in W.C.). For system testing at pressures less than or equal to 1/2 PSI (3.5 kPa) (13.84 in W.C.) the appliance must be isolated from the gas supply piping by closing its individual manual shutoff valve.
- You must follow the installation instructions and those in section "5. Venting" for adequate combustion air and exhaust.
- If this boiler's DHW system is connected to a closed water supply system, such as one having a backflow preventer in the cold water supply line, means shall be provided to control thermal expansion. Contact the water supplier or local plumbing inspector on how to control thermal expansion.
- Should overheating occur or the gas supply fail to shut off, turn off the manual gas control valve to the appliance.
- Combustion air must be free of chemicals, such as chlorine or bleach, that produce fumes. These fumes can damage components and reduce the life of your appliance.
- Where required by the authority having jurisdiction, the installation must comply with the Standard for Controls and Safety Devices for Automatically Fired Boilers, ANSI/ASME CSD-1.

- Ensure the wall is of sufficient strength to support the weight of the boiler, piping and any other components needed for installation; if it is not, please reinforce the wall as appropriate.
- Operating limits of the boiler:

Table 4

Maximum boiler set point temperature:	180°F (82 °C)
Maximum operating	45 PSI (3.1 bar)
Maximum allowable working temperature ASME:	210°F (99°C)
Maximum allowable working pressure ASME:	45 PSI (3.1 bar)

DO NOT

-  DO NOT install the boiler in an area where water leakage of the unit or connections will result in damage to the area adjacent to the appliance or to lower floors of the structure. When such locations cannot be avoided, it is required that a suitable drain pan, adequately drained, be installed under the boiler. The pan must not restrict combustion air flow.
-  DO NOT install the boiler in an area with negative air pressure.
-  DO NOT obstruct the flow of combustion and ventilation air.
-  DO NOT use substitute parts that are not authorized for this boiler.
-  DO NOT install the boiler on carpeting.
-  DO NOT install the boiler outdoor.

4.2 What You'll Need

Gather the recommended tools and parts before starting installation.

4.2.1 Items Needed

- Pressure/Temperature Gauge
 - Note:** When attaching the pressure/temperature gauge, please comply with applicable codes and the ASME standard.
- Low loss header or closely spaced tee
- Expansion tank for a closed heating system
- Air separator
- Standard tools for central heating, gas fitting, plumbing and electrical wiring.
- Digital manometer
- Digital multimeter capable of reading microamps
- pH digital meter or test strips
- For wall mounting bracket installation:
 - Level
 - Screws (use appropriate screws for type of wall construction)

4.2.2 Other Items You May Need

- Combustion analyzer (intended for use with condensing boilers)
- Hand truck with fastening belt

4.3 Items Included

Carefully unpack your boiler system and verify the following contents are included. If any items are damaged or missing, contact your local dealer/distributor. Do not attempt to use any item that appears damaged.

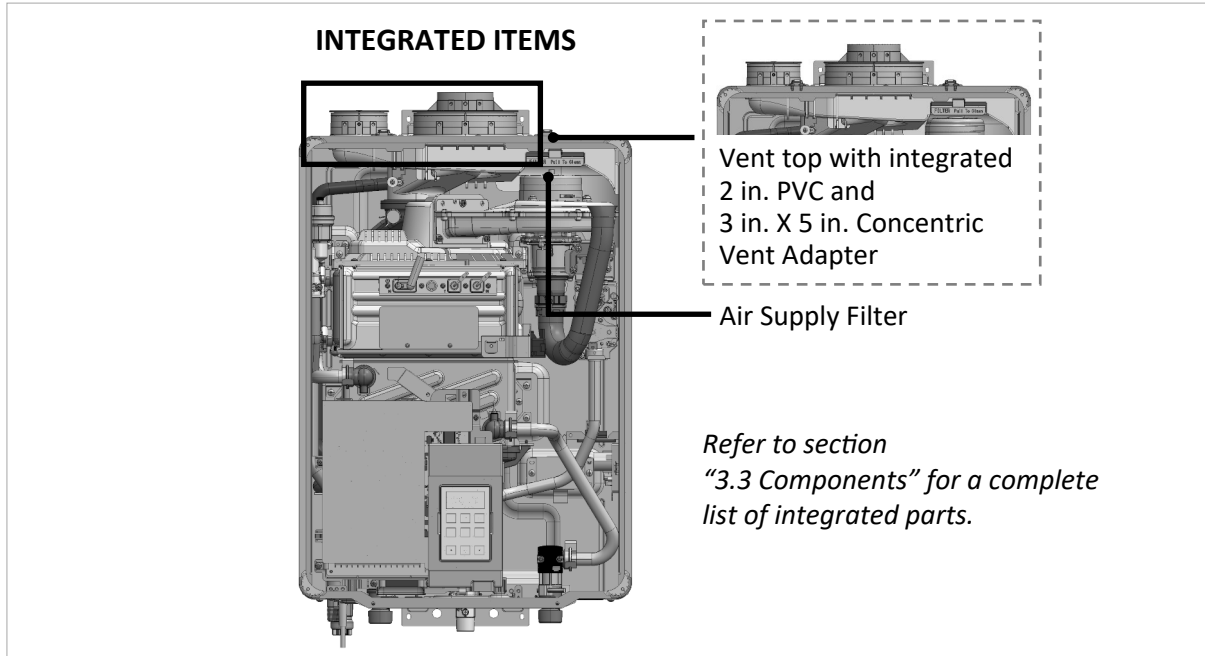
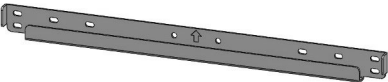





Figure 8

<p>WALL MOUNTING BRACKET</p>  <p>PART #: 109000628</p>	<p>PRESSURE RELIEF VALVE For Central Heating Systems</p>  <p>PART #: 807000211</p>	<p>OUTDOOR TEMPERATURE SENSOR</p> 
<p>VENT SCREENS</p>  <p>Vent screens (x2) and vent screen screws (x2). The vent screen prevents debris and other objects from entering the terminal. One vent screen is for the intake; the other is for the exhaust.</p>	<p>GAS CONVERSION LABEL</p> <p>This boiler is configured for Natural Gas only. Use this kit to convert to Propane Gas if needed. Contents include:</p> <div style="border: 1px solid black; padding: 5px;"> <p>Conversion Kit #: 803000040 for Gas <input type="text" value="NATURAL"/></p> <p>Gas Supply Pressure: Min. <input (1.99="" (3.36="" -="" <input="" kpa)="" kpa)<="" max="" p="" type="text" value="13.5" w.c.=""/> <p>This boiler was converted on _____ to _____ gas with kit No. _____</p> <p>(Name and address of organization making this conversion, who accepts the responsibility for the correctness of this conversion)</p> <p>This appliance has been converted for use with gas: <input type="text" value="PROPANE"/></p> </p></div>	
<p>DOCUMENTATION</p> <ul style="list-style-type: none"> • Installation and Operation Manual (this manual) • User Manual • Technical Data Sheet (located on inside of boiler front panel) • "Key Points for a Successful Installation" Sheet (adhered to boiler front panel) 		

4.4 Choose an Installation Location

When choosing an installation location, you must ensure that clearances will be met and that the vent length will be within required limits. Consider the installation environment, water quality, and need for freeze protection. Requirements for the gas line, water lines, electrical connection, and condensate disposal can be found in their respective installation sections in this manual.

This section provides information on the importance of water quality to the Rinnai Condensing Boiler. The information is intended to serve as general guidelines only and is not a complete list of water quality guidelines.

4.4.1 Water Quality Guidelines

Consideration of care for your boiler should include evaluation of water quality.

- The water must be potable, free of corrosive chemicals, sand, dirt, or other contaminants.
- It is up to the installer to ensure the water does not contain corrosive chemicals or elements that can affect or damage the boiler.
- Water that contains chemicals exceeding the levels below can damage the boiler.

Table 5

Contaminant	Maximum Level
Total Hardness	Up to 200 mg/L
Aluminum *	Up to 0.2 mg/L
Chlorides *	Up to 250 mg/L
Copper *	Up to 1.0 mg/L
Dissolved Carbon Dioxide	Up to 15.0 mg/L
Iron *	Up to 0.3 mg/L
Manganese *	Up to 0.05 mg/L
pH *	6.5 to 8.5
TDS (Total Dissolved Solids) *	Up to 500 mg/L
Zinc *	Up to 5 mg/L

* Source: Part 143 National Secondary Drinking Water Regulations

- Unsuitable heating system water can cause the formation of scale or sludge, which affects system efficiency. It can also cause corrosion and reduce life of the heat exchanger.
- Never use water that has been treated by a reverse osmosis, deionized, or distilled water to soften the water to fill the heating system.
- For Domestic Hot Water systems, if you install the boiler in an area that is known to have hard water or that causes scale build-up, the water must be treated and may require a more frequent flushing schedule. Scale build-up is caused by hard water and can be accelerated if the boiler is set at a high temperature. Rinnai offers Southeastern Filtration's "Scale Cutter Water Conditioning System" that offers superior lime scale prevention and corrosion control by feeding a blend of control compounds into the cold water supply.
- Oxygen permeable or rubber tubing is not permitted in the heating system unless it is separated from the boiler by a plate heat exchanger.
- Thoroughly flush the system prior to filling. While flushing, isolate the boiler.
- Do not introduce any system cleaner into the boiler. Flush the system thoroughly to remove all system cleaner before filling the boiler with water.
- When freeze protection of the heating system is desired, only use Rinnai-approved antifreezes. The allowed maximum concentration is 40%.
- Reference section "14.1 Approved Cleaners, Inhibitors and Antifreezes" in the Appendix for an approved list of system cleaners, inhibitors, and antifreezes.

IMPORTANT

Replacement of components due to water quality damage is not covered by the warranty.

4.4.2 Environment

- Air surrounding the boiler, venting, and vent termination(s) is used for combustion and must be free of any compounds that cause corrosion of internal components.
- These include corrosive compounds that are found in aerosol sprays, detergents, bleaches, cleaning solvents, oil-based paints/varnishes, and refrigerants. The air in hair/nail salons, spas, dry cleaning stores, photo processing labs, and storage areas for pool supplies often contains these compounds. In applications utilizing room air where there are high levels of particulates, Rinnai offers a room air screen.
- The boiler, venting, and vent termination(s) should not be installed in any areas where the air may contain these corrosive compounds.
- Install the boiler as far away as possible from any air inlet vents. Corrosive fumes, sometimes found in hair/nail salons, spas, or other industries exposed to toxic fumes, may be released through these vents when not in operation. Chemicals that are corrosive in nature should not be stored or used near the boiler or vent termination. This requirement applies to indoor installations.
- In coastal regions, the boiler should be installed so that it is sheltered/protected from exposure to sea breeze. Exposure to salty spray or breeze can cause corrosion of the boiler.
- DO NOT install the boiler in areas where intake air might be contaminated with chemicals.
- DO NOT use room air in applications where the indoor air is corrosive. Install the boiler as direct vent in a sealed closet so that it is protected from the potential of contaminated indoor air.
- Install the boiler and/or vent termination as far away as possible from exhaust vent hoods and dryer vents.
- Damage and repair due to corrosive compounds in the air is not covered by warranty.

4.4.3 Clearances

Table 6

Location	Clearance to Combustibles and Non-Combustibles
Top	2 in. (51 mm) (0 in. from vent components)
Bottom/Ground	12 in. (305 mm)
Front	0 in. (Clearance for servicing is 24 in. / 610 mm in front of boiler)
Back	0 in.
Sides (<i>Left and Right</i>)	2 in. (51 mm)
Vent	0 in.

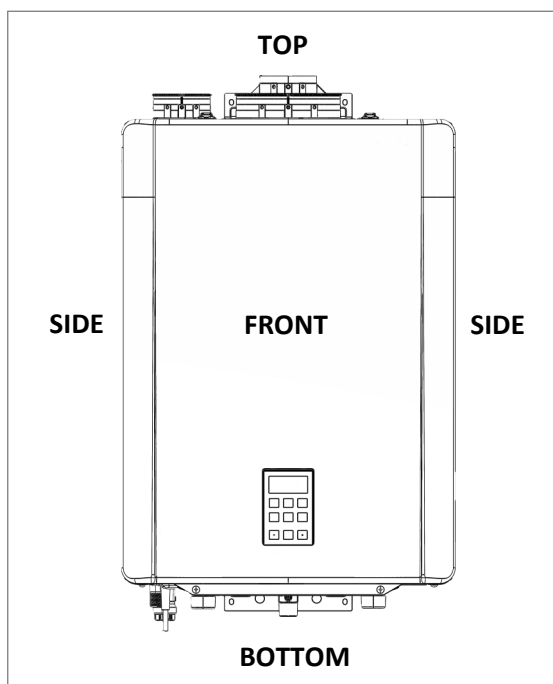

Figure 9

CAUTION

If clearances are not met, damage to the property and boiler may occur.

4.4.4 Installation Location Checklist

Use this checklist to ensure you have selected the correct location for the boiler.

<input type="checkbox"/>	The boiler is not exposed to corrosive compounds in the air.
<input type="checkbox"/>	The boiler location complies with the required clearances.
<input type="checkbox"/>	The planned combustion air and exhaust termination locations meet the required clearances.
<input type="checkbox"/>	The water supply does not contain chemicals or exceed total hardness that will damage the
<input type="checkbox"/>	A standard 3 prong 120 VAC, 60 Hz properly grounded wall outlet or other 120 VAC, 60 Hz
<input type="checkbox"/>	The installation must conform with local codes or, in the absence of local codes, with the <i>National Fuel Gas Code, ANSI Z223.1/NFPA 54</i> , or the <i>Natural Gas and Propane Installation Code, CSA B149.1</i> .

4.5 Mount the Boiler to the Wall

You Will Need:

- Rinnai Condensing Boiler
- Wall Mounting Bracket

Supplied by Installer:

- Level
- Four screws for mounting bracket installation
- Screws for top and bottom bracket installation

Use appropriate screws for type of wall construction.

Instructions:

- 1 Hold the wall mounting bracket up against the wall and use a level to make sure the bracket is even. Proper operation requires the boiler to be level.

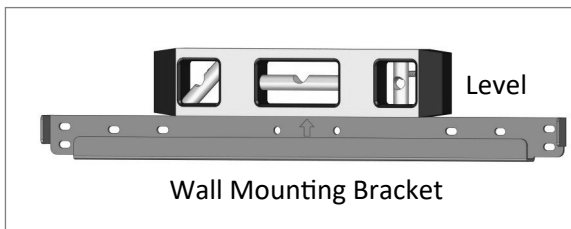

Figure 10

- 2 Use four screws to secure the wall mounting bracket to the wall (two screws on far left side and two screws on far right side).

Use the appropriate screws for the wall construction to secure the mounting bracket to the wall between two studs.

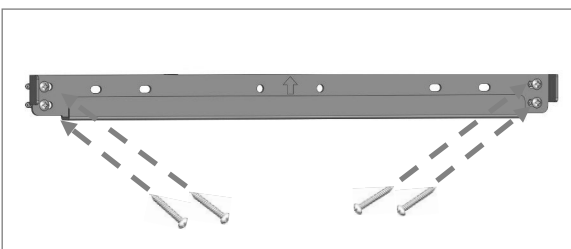

Figure 11

- 3 Insert the top bracket into the wall mounting bracket. Make sure the wall mounting bracket is attached to the wall and can hold the weight of the boiler before you fully let go.

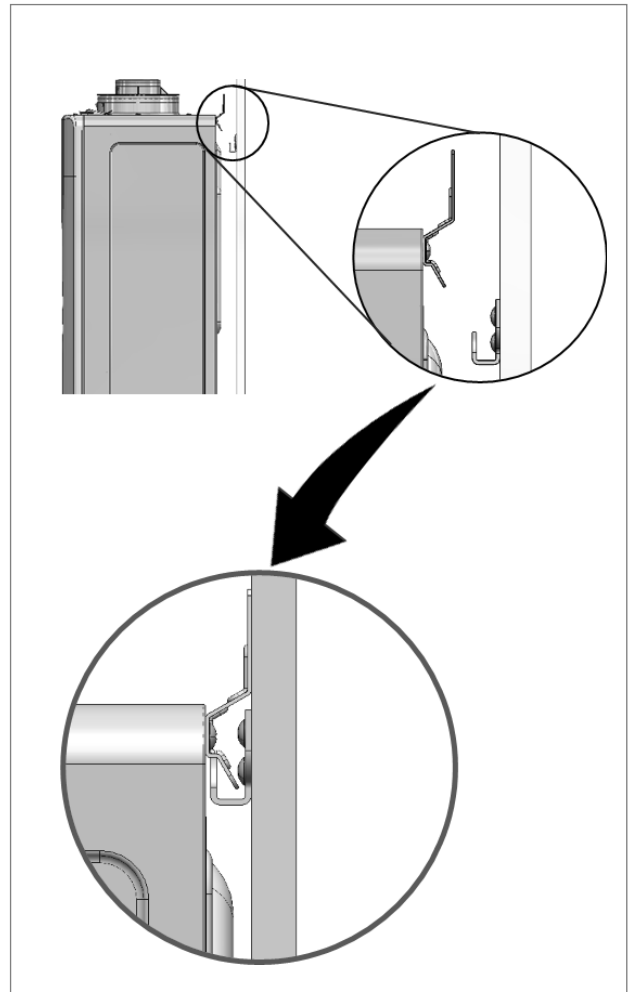

Figure 12

Steps continued on next page.

- 4 Securely screw the top and bottom brackets into the wall, making sure the screws are flush with the wall.
- Use any of the holes in the top and bottom brackets.
 - Make sure the securing method is sufficient to support the weight of the boiler. Refer to the boiler weight in section “3.4 Specifications” of this manual.

IMPORTANT

The boiler must be installed in an upright and level position. Do not install the boiler upside down or on its side.

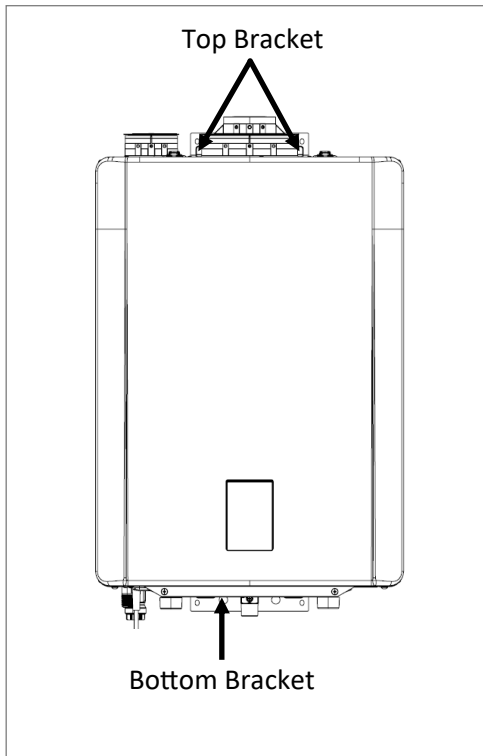

Figure 13

4.6 Fill the Condensate Collector

WARNING

Before operation of the boiler, the condensate collector must be filled with water. This is to prevent the potential of exhaust gasses from entering the building. Failure to fill the condensate collector could result in severe personal injury or death.

The condensate collector must be filled with water prior to installing the vent system.

Pour approximately 10 ounces (1.25 cups) of water directly into the boiler’s exhaust port (do not remove the 2 in. PVC adapter prior to this).

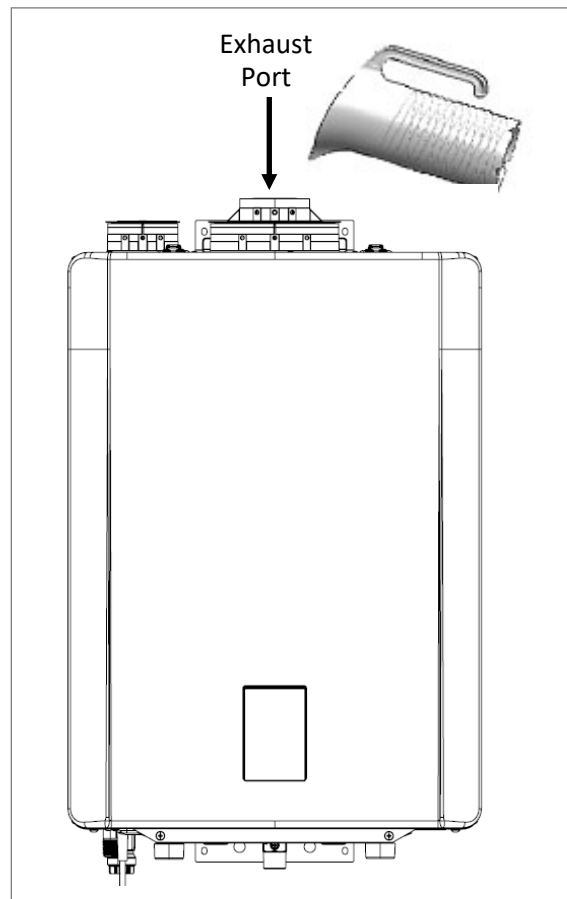

Figure 14

5. Venting

Topics in this section

- Guidelines
- Venting Installation Sequence
- Termination Considerations
- PVC Venting Safety Switch
- Venting Options

5.1 Guidelines

- I-Series Plus boilers can be installed in direct vent or non-direct vent applications.
 - When installed as Direct Vent, refer to the following section for a complete list of approved vent manufacturers and products: “5.5.1 Direct Vent: Approved Vent Manufacturers and Products.”
 - When installed as Non-Direct Vent (Room Air), the vent must be Category IV and of a type listed by a national recognized testing agency.
 - Exhaust must be directly vented to the outside. Combustion air can be provided from outside (Direct Vent) or from room air (Non-Direct Vent).
 - If using room air (Non-Direct Vent) for combustion, ensure the required volume of indoor air is available in accordance with one of the following:
 - A The National Fuel Gas Code, ANSI Z223.1/NFPA 54;
 - B CSA B149.1, Natural Gas and Propane Installation Code; or
 - C Applicable provisions of the local building code.
 - Avoid dips or sags in horizontal vent runs by installing supports per the vent manufacturer’s instructions.
 - Support horizontal vent runs every 4 ft (1.2 m) and all vertical vent runs every 6 ft (1.83 m) or as per vent manufacturer’s instructions or local code requirements.
- Venting should be as direct as possible with a minimum number of pipe fittings.
 - For manufactured vent systems, vent connections must be firmly pressed together so that the connections form an air tight seal. Follow the venting manufacturer’s instructions.
 - Refer to the schedule 40 PVC/CPVC manufacturer for appropriate fittings, solvents or joining methods.
 - If venting reassembly is needed, follow the steps for installing the venting in the following sections. Make certain that the vent piping and seals are not damaged. Only use sealants, primers, or glues that are approved for the vent material in use.
 - Refer to the instructions of the vent system manufacturer for component assembly instructions.
 - If the vent system is to be enclosed, it is suggested that the design of the enclosure shall permit inspection of the vent system. The design of such enclosure shall be deemed acceptable by the installer or the local inspector.
 - Any issues resulting from improper vent installation will not be covered by warranty.

WARNING

- DO NOT use cellular core PVC/CPVC.
- DO NOT use Radel, ABS, or galvanized material to vent this appliance.
- DO NOT cover non-metallic vent pipe and fittings with thermal insulation.
- DO NOT combine vent components from different manufacturers.
- DO NOT reduce the vent diameter. Vent diameter cannot be less than 2 in.
- DO NOT connect the venting system with an existing vent or chimney.
- DO NOT common vent with the vent pipe of any other manufacturer’s boiler or appliance.

IMPORTANT

If reusing existing venting, the venting should be inspected for damage and to ensure it is appropriate (approved) for this boiler. To ensure safe and proper operation, damaged vent components **MUST** be replaced before operating the boiler.

5.2 Venting Installation Sequence

1. Determine the termination method—horizontal or vertical, concentric, or twin pipes, etc.
2. Determine proper location for wall or roof penetration for each termination.
3. Install termination assembly as described in this manual or in the vent manufacturer's installation instructions.
4. Install air and vent piping from boiler to termination.
5. Slope horizontal exhaust run towards the boiler 1/4 in per foot. DO NOT slope combustion air pipe towards boiler.
6. Install vent supports and brackets allowing for movement from expansion, or as per vent manufacturer's instructions or local code requirements.
7. *(Optional step)* Install vent screen or room air filter (not included with purchase) on schedule 40 PVC combustion air and exhaust termination elbows as illustrated below.

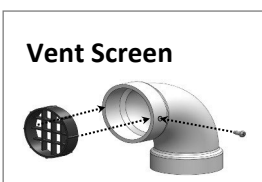

Figure 15

- Press vent screen inside of termination piece/ elbow.
- Secure vent screen to the elbow with screw.

5.3 Termination Considerations

Check to determine whether local codes supersede the following clearances:

- Avoid termination locations near a dryer vent.
- Avoid termination locations near commercial cooking exhaust.
- Avoid termination locations near any air inlets.
- You must install a vent termination at least 12 in above the ground or anticipated snow level.

The vent for this appliance shall not terminate:

- Over public walkways.
- Near soffit vents or crawl space vents or other area where condensate or vapor could create a nuisance or hazard or cause property damage.
- Where condensate or vapor could cause damage or could be detrimental to the operation of regulators pressure relief valves, or other equipment.

Listed below are important considerations for locating vent termination under a soffit (ventilated or unventilated or eave vent; or to a deck or porch):

- Do not install vent termination under a soffit vent such that exhaust can enter the soffit vent.
- Install vent termination such that exhaust and rising moisture will not collect under eaves. Discoloration to the exterior of the building could occur if installed too close.
- Do not install the vent termination too close under the soffit where it could present recirculation of exhaust gases back into the combustion air intake of the termination.

Horizontal portions of the venting system shall be supported to prevent sagging:

- For category IV boilers, have horizontal runs sloping upwards not less than 1/4 in. per foot (21 mm/m) from the boiler to the vent terminal;
- For category IV boilers, be installed so as to prevent accumulation of condensate; and
- For category IV boilers, where necessary, have means provided for drainage of condensate.

5.4 PVC Venting Safety Switch

⚠ WARNING The instructions in this section explain how to adjust boiler settings to allow for higher exhaust temperatures. These instructions apply only for installations using CPVC, listed Polypropylene, or stainless steel venting. If these instructions are not followed exactly, a fire or carbon monoxide leak may result causing property damage, personal injury, or death.

DO NOT adjust boiler settings to allow higher exhaust temperatures when venting with PVC.

This product is equipped with safety devices to control the exhaust temperature which allows for a variety of venting materials to be used in its final installation. The boiler is set up from the factory to be installed with a PVC venting system and a built-in control to limit the exhaust temperature to be below 149°F (65°C). In high temperature applications where the exhaust temperature can exceed 149°F (65°C), CPVC, listed Polypropylene (PP), or stainless steel venting must be used. The choice of venting materials may have an impact on overall performance. Also, If the vent material is other than PVC (CPVC, listed PP or stainless steel) follow the procedure below to adjust the internal settings.

5.4.1 High Temperature Vent Setting Instructions

See section “9.4 Initial Settings” for initial installation. To set up later, follow the below steps.

1. Remove the boiler’s front panel by removing the two screws that secure the panel.
2. Locate the PC Board (lower left side of unit).
3. Press and hold the SW1 left button on the PC Board.

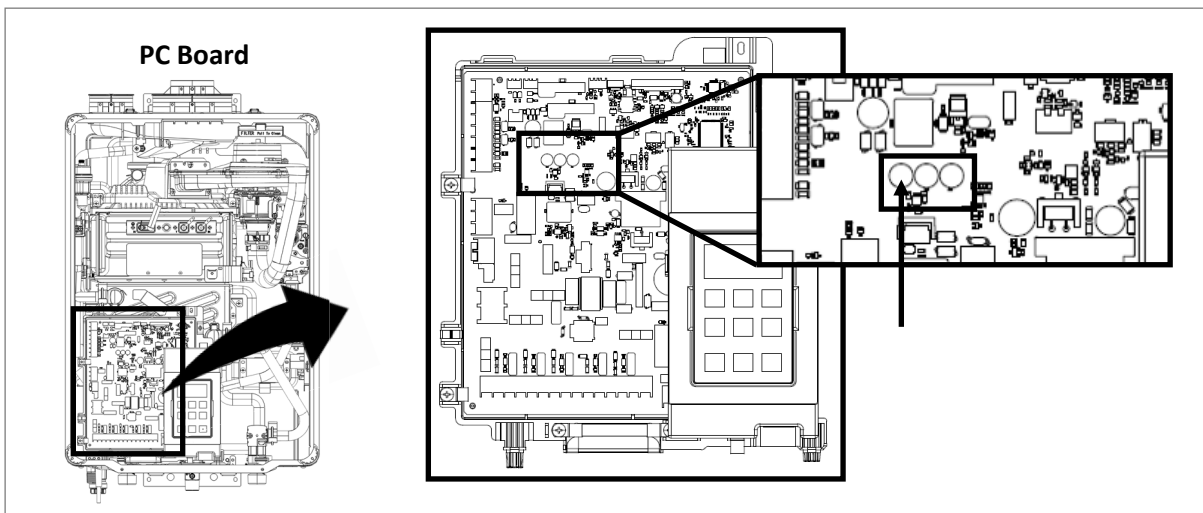

Figure 16

4. Scroll to Parameter R2 by pressing the up and down arrows. Adjust Parameter R2 to “b” to confirm higher temperature vent materials are in use.
5. The boiler is now set to allow higher exhaust temperatures. To exit parameter settings and enter normal operation mode, press the SW1 left button on the PC Board.
6. Replace the boiler’s front panel by reinserting the two screws that secure the panel.

5.5 Venting Options

Two venting options are available: Direct Vent and Non-Direct Vent (Room Air).

Option 1 Direct Vent (Concentric and Twin Pipe)

See the **Direct Vent** section for complete details.

Concentric Pipe

Combustion air and exhaust vent directly through a single concentric connection. Hot exhaust exits through the interior pipe, while combustion air enters through the outer pipe.

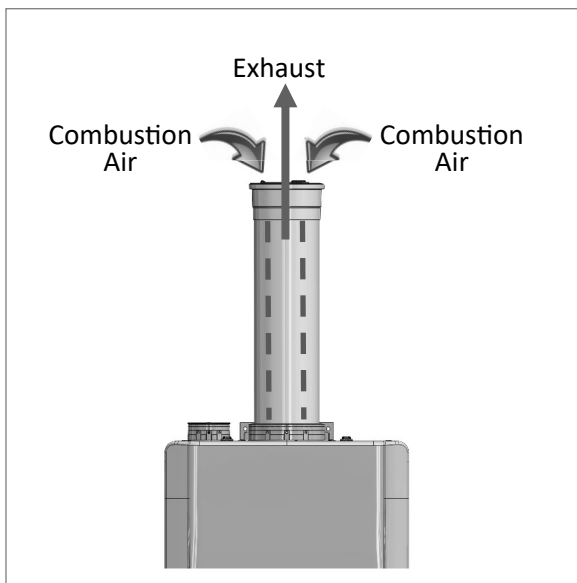

Figure 17

Twin Pipe

Combustion air and exhaust vent directly through separate penetrations.

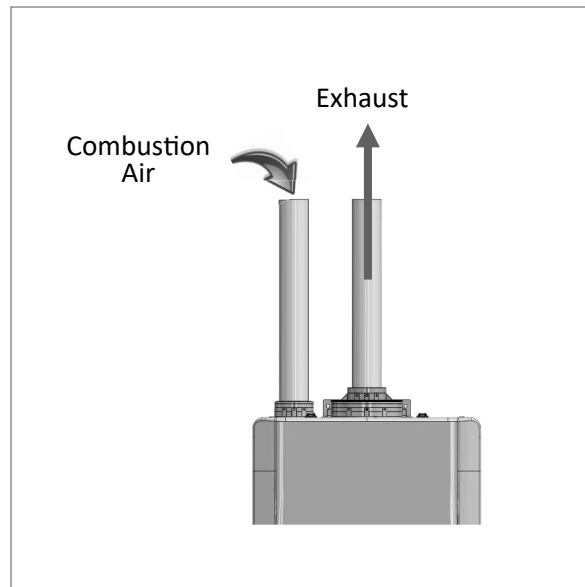

Figure 18

Option 2 Non-Direct Vent (Room Air)

See the **Non-Direct Vent** section for complete details.

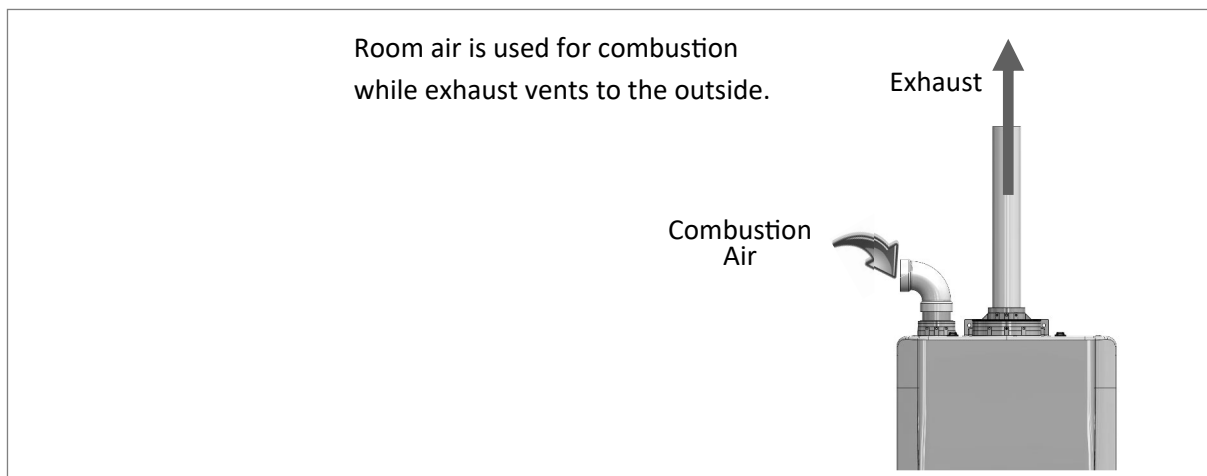

Figure 19

5.5.1 Direct Vent: Approved Vent Manufacturers and Products







Following is a list of vent components and terminations for Direct Vent installations (concentric and twin pipe). Install the correct venting for your model according to the venting manufacturer's instructions and the guidelines below. The information below is correct at time of publication and is subject to change without notice. Contact the vent manufacturer for questions related to the vent system, products, part numbers and instructions.











Table 7

Manufacturer	Phone	Web Site
Ubbink	800-621-9419	www.rinnai.us
Centrotherm	877-434-3432	www.centrotherm.us.com
Heat-Fab	800-772-0739	www.heatfab.com
Metal Fab	800-835-2830	www.metal-fabinc.com
IPEX	U.S.: 800-463-9572 Canada: 866-473-9462	www.ipexamerica.com, www.ipexinc.com
DuraVent	800-835-4429	www.duravent.com
Royal	800-232-5690	www.royalbuildingproducts.com
ECCO Manufacturing	877-955-4805	www.eccomfg.com
DiversiTech	800-995-2222	www.diversitech.com
Z-FLEX	603-669-5136	www.z-flex.com

2 in./4 in. CONCENTRIC VENT TERMINATIONS

Table 8











Manufacturer	Manufacturer Part Number	Product Description	Diagram	Horizontal	Vertical	Equivalent Length (ft)
2 in./4 in. CONCENTRIC VENT TERMINATIONS						
UBBINK	229011NPP 229012NPP, 229031 229013NPP, 229032	2/4 Condensing Horizontal Term Kit 8.7 in. 2/4 Condensing Horizontal Term Kit 12 in. 2/4 Condensing Horizontal Term Kit 21 in.		✓		5
	224356NPP, 224359	2/4 Condensing Roof Discharge Termination 20 in. above roof			✓	5
	710202NPP	2/4 Condensing 90 Degree Diverter Nose (Use with Wall Terminal)		✓		5
	710215NPP	2/4 Condensing 45 Degree Diverter Nose (Use with Wall Terminal)		✓		5
IPEX	196005, 197040	FGV Concentric Vent Kit (16 in. length)		✓	✓	20
	196005PVC (Order from Rinnai)					
	196105, 197033	FGV Concentric Vent Kit (28 in. length)		✓	✓	20
	196105PVC (Order from Rinnai)					
	196125	FGV Concentric Vent Kit (40 in. length)		✓	✓	20
	196125PVC (Order from Rinnai)					

Manufacturer	Manufacturer Part Number	Product Description	Diagram	Horizontal	Vertical	Equivalent Length (ft)
2 in./4 in. CONCENTRIC VENT TERMINATIONS (Continued)						
ROYAL	52CVKGV6502	PVC Concentric Vent Kit 2 in. x 16 in.		✓	✓	20
	52CVKGV6502-28	PVC Concentric Vent Kit 2 in. x 28 in.		✓	✓	20
	52CVKGV6502-40	PVC Concentric Vent Kit 2 in. x 40 in.		✓	✓	20
CENTROTHERM	ICRT2439	2 in. x 4 in. Concentric Roof Termination			✓	20
DURAVENT	2PPS-VKL/VK-TCL	2 in. x 4 in. Vertical Termination Cap Kit-Concentric			✓	20
	2PPS-HKL	2 in. x 4 in. Horizontal Termination Kit-Concentric		✓		20
ECCO	190288	2 in. x 4 in. Concentric Horizontal Termination		✓		5
	190295	2 in. x 4 in. Concentric Vertical Termination			✓	5
DIVERSITECH	CVENT-2	2 in. x 4 in. Concentric Horizontal Termination		✓	✓	20
Z-FLEX	2ZDCTH24	2 in. x 4 in. Concentric Horizontal Termination		✓		5
	2ZDCTV24	2 in. x 4 in. Concentric Roof Termination			✓	5

3 in./5 in. CONCENTRIC VENT TERMINATIONS







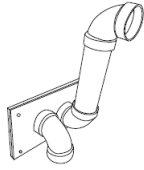



Table 9

Manufacturer	Manufacturer Part Number	Product Description	Diagram	Horizontal	Vertical	Equivalent Length (ft)
3 in./5 in. CONCENTRIC VENT TERMINATIONS						
UBBINK	223174PP 223176PP 223177PP	3/5 Condensing Horizontal Term Kit 8.7 in. 3/5 Condensing Horizontal Term Kit 12 in. 3/5 Condensing Horizontal Term Kit 21 in.		✓		5
	223186PP	3/5 Condensing Horizontal Diverter Termination Kit 19 in.		✓		16
	224047PP	3/5 Condensing Raised Horizontal Termination Kit		✓		24
	184162PP	3/5 Condensing Roof Discharge Termination 20 in. above roof			✓	5
IPEX	196006, 197009	FGV Concentric Vent Kit 3 in. x 20 in.		✓	✓	20
	196006PVC (Order from Rinnai)					
	196106, 197107	FGV Concentric Vent Kit 3 in. x 32 in.		✓	✓	20
	196106PVC (Order from Rinnai)					
	196116, 197117	FGV Concentric Vent Kit 3 in. x 44 in.		✓	✓	20
196116PVC (Order from Rinnai)						
ROYAL	52CVKGV6503 (PVC)/ 52CVKGVSF9003 (CPVC)	PVC/CPVC Concentric Vent Kit 3 in. x 20 in.		✓	✓	20
	52CVKGV6503-32 (PVC)/ 52CVKGVSF9003-32 (CPVC)	PVC/CPVC Concentric Vent Kit 3 in. x 32 in.		✓	✓	20
	52CVKGV6503-44 (PVC)/ 52CVKGVSF9003-44 (CPVC)	PVC/CPVC Concentric Vent Kit 3 in. x 44 in.		✓	✓	20
HEAT-FAB	SC03HT	Horizontal Termination Adapter		✓		20
	SC03VT	Vertical Termination Adapter			✓	20
CENTRO-THERM	ICRT3539	3"/5" Concentric Roof Termination PPs-UV			✓	20

Manufacturer	Manufacturer Part Number	Product Description	Diagram	Horizontal	Vertical	Equivalent Length (ft)
3 in./5 in. CONCENTRIC VENT TERMINATIONS (Continued)						
METAL-FAB	3CGRLSV	Vertical Adapter			✓	1
	3CGRLSH	Horizontal Adapter		✓		6
	3CGRVT	Vertical Termination			✓	5
	3CGRHT	Horizontal Termination		✓		16
DURAVENT	3PPS-VKL/VK-TCL	3 in. x 5 in. Vertical Termination Cap Kit-Concentric			✓	20
	3PPS-HKL	3 in. x 5 in. Horizontal Termination Kit-Concentric		✓		20
ECCO	190388	3 in. x 5 in. Concentric Horizontal Termination		✓		5
	190395	3 in. x 5 in. Concentric Vertical Termination			✓	5
DIVERSITECH	CVENT-3	3 in. x 5 in. Concentric Horizontal Termination		✓	✓	20
Z-FLEX	2ZDCTH35	3 in. x 5 in. Concentric Horizontal Termination		✓		5
	2ZDCTV35	3 in. x 5 in. Concentric Roof Termination			✓	5











2 in. TWIN PIPE TERMINATIONS

Table 10

Manufacturer	Manufacturer Part Number	Product Description	Diagram	Horizontal	Vertical	Equivalent Length (ft)
2 in. TWIN PIPE TERMINATIONS						
CENTROTHERM	ISELL0287UV	2 in. 87° Long PPS-UV		✓		6
	ISTT0220	2 in. Termination Tee		✓		6
	ISLPT0202	2 in. Low Profile Wall Termination		✓		5
DURAVENT	2PPS-HTPL	2 in. Twin Pipe Termination		✓		10
	2PPS-HSTL	2 in. Single Horizontal Termination		✓		6
	2PPS-TBL	2 in. Black UV Resistant Tee		✓		5
IPEX	196984	FGV PVC Low Profile Termination Kit		✓		5
	196984PVC (Order from Rinnai)					
	081216	FGV PVC Wall Termination Kit		✓		16
ROYAL	52SWVKGVS6502	PVC Side Wall Vent Kits		✓		5
	52WTVKGVS6502	PVC Wall Vent Kits		✓		16
DIVERSITECH	HVENT-2	2 in. Low Profile Horizontal Vent Kit		✓		5

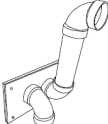
3 in. TWIN PIPE TERMINATIONS

Table 11

Manufacturer	Manufacturer Part Number	Product Description	Diagram	Horizontal	Vertical	Equivalent Length (ft)
3 in. TWIN PIPE TERMINATIONS						
CENTROTHERM	ISELL0387UV	3 in. 87° Long PPS-UV		✓		6
	ISTT0320	3 in. Termination Tee		✓		6
	ISLPT0303	3 in. Low Profile Wall Termination		✓		5
DURAVENT	3PPS-HTPL	3 in. Twin Pipe Termination		✓		10
	3PPS-HSTL	3 in. Single Horizontal Termination		✓		5
	3PPS-TBL	3 in. Black UV Resistant Tee		✓		6
IPEX	196985	FGV PVC Low Profile Termination Kit		✓		5
	196985PVC (Order from Rinnai)					
	081219	FGV PVC Wall Termination Kit		✓		16
ROYAL	52SWVKGVS6503	PVC Side Wall Vent Kits		✓		5
	52WTVKGVS6503	PVC Wall Vent Kits		✓		16
DIVERSITECH	HVENT-3	3 in. Low Profile Horizontal Vent Kit		✓		5

VARIOUS 2 in. OR 3 in. SCHEDULE 40 PVC/CPVC TERMINATIONS

Table 12



Product Description	Image	Horizontal	Vertical	Equivalent Length (ft)
Air Filter Screen		✓	✓	N/A
Tee		✓	✓	5
90° Elbow		✓	✓	5
45° Elbow		✓	✓	2.5

Table 13

Approved PVC/CPVC Vent and Air Piping Material			
Item	Material	Standard for Installation in North America	
		United States	Canada
Thermoplastic Piping Materials			
Vent or Combustion Air Intake Pipe and Fittings	PVC Schedule 40	ANSI/ASTM D1785	Thermoplastic vent pipe must be certified to ULC S636. Intake pipe may be of the materials listed in this table.
	PVC-DWV	ANSI/ASTM D2665	
	CPVC Schedule 40	ANSI/ASTM F441	
PVC Pipe Cement and Primer	PVC	ANSI/ASTM D2564	
	CPVC Schedule 40	ANSI/ASTM F493	
PVC Vent Screens			
Termination Vent Screens	Polyethylene	<ul style="list-style-type: none"> • 2 in. Vent Screens (included in carton box) (IPEX Part Number: 196050) • 3 in. Vent Screens (IPEX Part Number: 196051) 	

Exhaust piping must be of solid core material. Refer to the PVC/CPVC manufacturer for appropriate fittings, solvents or joining methods.

APPROVED VENTING MATERIALS BY MANUFACTURER

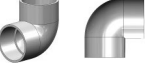
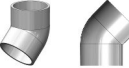
Table 14

Manufacturer	Vent Material
Ubbink	PVC (Outer Vent), Polypropylene (Inner Vent)
Centrotherm	Polypropylene
Heat-Fab	Metal
Metal Fab	Metal
IPEX	PVC/CPVC
DuraVent	Polypropylene
Royal	PVC
ECCO Manufacturing	Polypropylene
DiversiTech	PVC/CPVC
Z-FLEX	Polypropylene

5.5.2 Direct Vent (Concentric and Twin Pipe): Termination Clearances

The information below applies to Concentric and Twin Pipe.

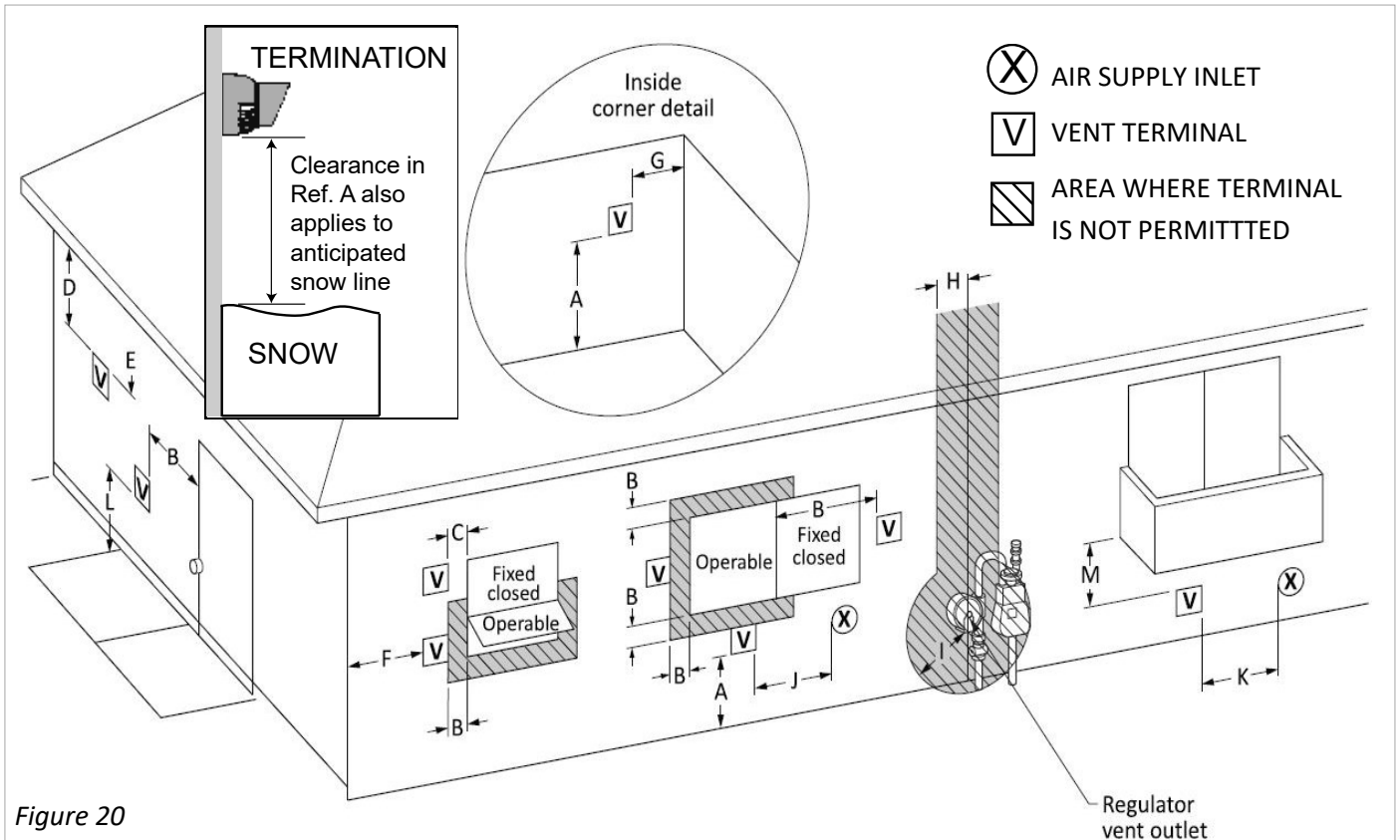

Figure 20

Table 15

Ref	Description	Canadian Installations (CSA B149.1)	U.S. Installations (ANSI Z223.1 /NFPA 54)
		Direct Vent (Indoor Unit)	Direct Vent (Indoor Unit)
A	Clearance above grade, veranda, porch, deck, or balcony	12 in. (30 cm)	12 in. (30 cm)
B	Clearance to window or door that may be opened	<ul style="list-style-type: none"> 6 in. (15 cm) for appliances ≤10,000 Btu/hr 12 in. (30 cm) for appliances > 10,000 Btu/hr and ≤ 100,000 Btu/hr 36 in. (91 cm) for appliances > 100,000 Btu/hr 	12 in. (30 cm)
C	Clearance to permanently closed window	*	*
D	Vertical clearance to ventilated soffit, located above the terminal within a horizontal distance of 2 ft (61 cm) from the center line of the terminal	*	*
E	Clearance to unventilated soffit	*	*
F	Clearance to outside corner	*	*
G	Clearance to inside corner	*	*
H	Clearance to each side of center line extended above meter/regulator assembly	*	*
I	Clearance to service regulator vent outlet	Above a regulator within 3 ft (91 cm) horizontally of the vertical center line of the regulator vent outlet to a maximum vertical distance of 15 ft (4 m)	*
J	Clearance to non-mechanical air supply inlet to building or the combustion air inlet to any other appliance	36 in. (91 cm)	12 in. (30 cm)
K	Clearance to a mechanical air supply inlet	6 ft (1.83 m)	3 ft (91 cm) above if within 10 ft (3 m) horizontally
L	Clearance above paved sidewalk or paved driveway located on public property	7 ft (2.13 m) [1]	*
M	Clearance under veranda, porch, deck, or balcony	12 in. (30 cm) [2]	*

Table 16

Clearance to opposite wall is 24 in. (60 cm).	
[1] A vent shall not terminate directly above a sidewalk or paved driveway that is located between two single family dwellings and serves both dwellings.	* Clearances are in accordance with local installation codes and the requirements of the gas supplier.
[2] Permitted only if veranda, porch, deck, or balcony is fully open on a minimum of two sides beneath the floor.	

5.5.3 Direct Vent: Concentric Pipe

Concentric Pipe: Termination Clearances

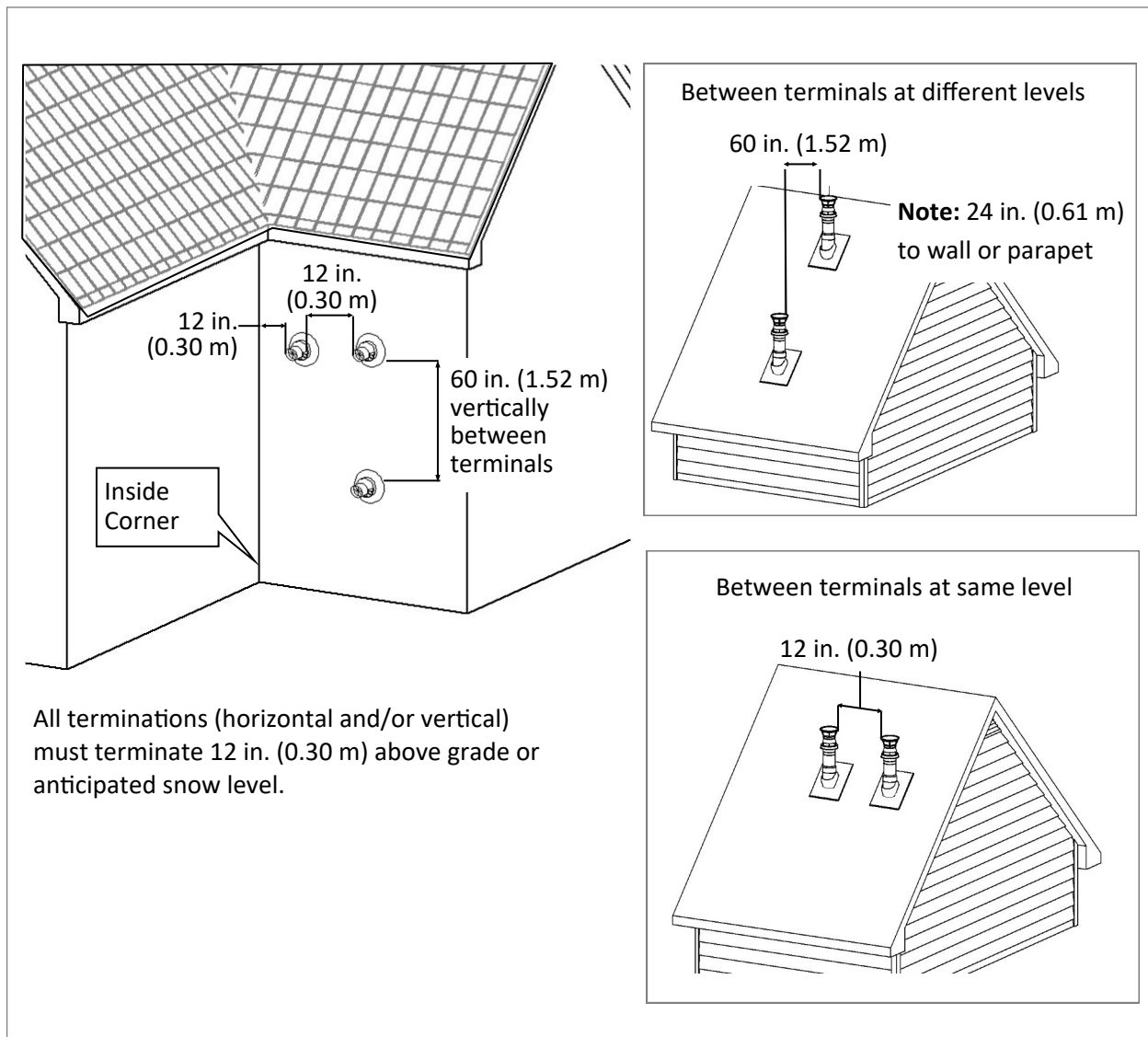

Figure 21

Concentric Pipe: Maximum Equivalent Vent Length

Table 17

Vent Sizes:	2 in. X 4 in.	3 in. X 5 in.
Vent Lengths:	75 ft (23 m)	160 ft (49 m)
<ul style="list-style-type: none"> • 45° elbow is equivalent to 3 ft (1 m) • 90° elbow is equivalent to 6 ft (2 m) 		

Concentric Pipe: Installation Instructions

1. Remove and discard screw from concentric flue connection.

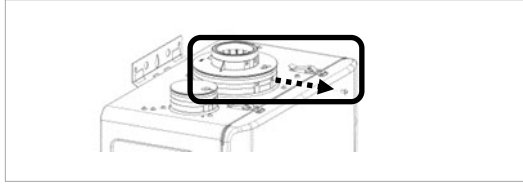

Figure 22

2. Remove exhaust adapter ring (discard for concentric venting configurations.)

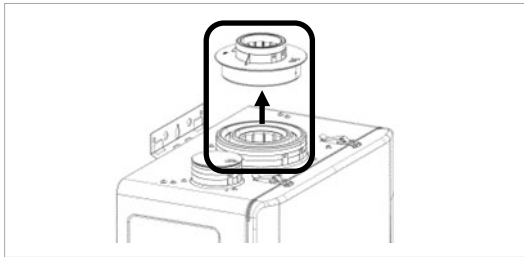

Figure 23

3. Install the concentric vent. Ensure it is properly seated.

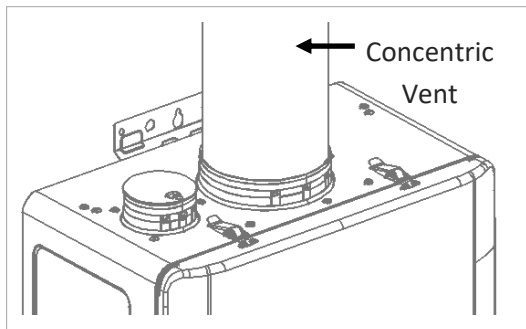

Figure 24

4. Secure the vent pipe to the concentric flue connection with the supplied screws.

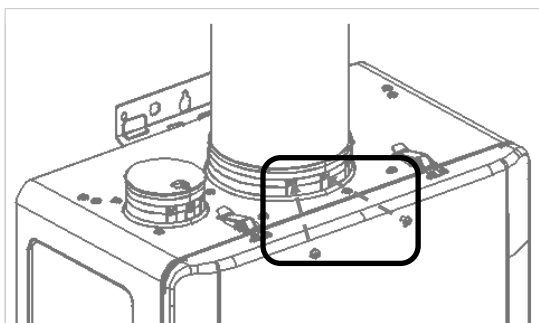

Figure 25



IMPORTANT

Install the venting termination according to the diagrams and instructions in this manual. Slope the venting 1/4 in. per foot (21 mm per meter) toward the appliance according to the vent manufacturer's installation instructions. Dispose of condensate per local codes.

Table 18

Horizontal Wall Terminations	Vertical Roof Terminations
2 in. x 4 in. 	2 in. x 4 in. and 3 in. x 5 in.
3 in. x 5 in. 	

Table 19

Vent Sizes	2 in / 4 in (51 mm/100 mm)	3 in / 5 in (76 mm/125 mm)
45° Elbow	3 ft (1 m)	2.5 ft (0.7 m)
90° Elbow	6 ft (2 m)	5 ft (1.5 m)

5.5.4 Direct Vent: Twin Pipe

Twin Pipe: Termination Clearances

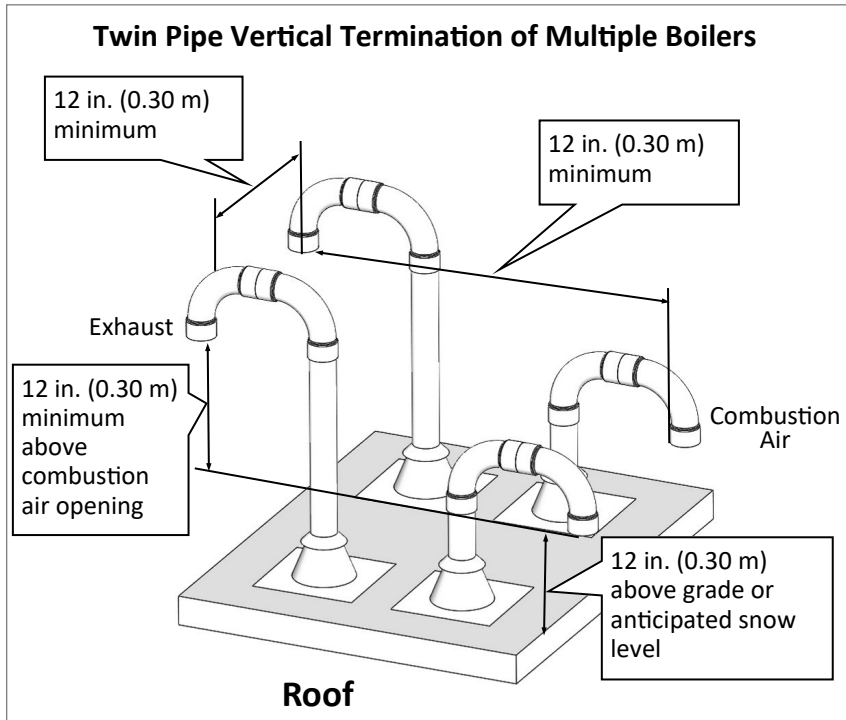

Figure 26

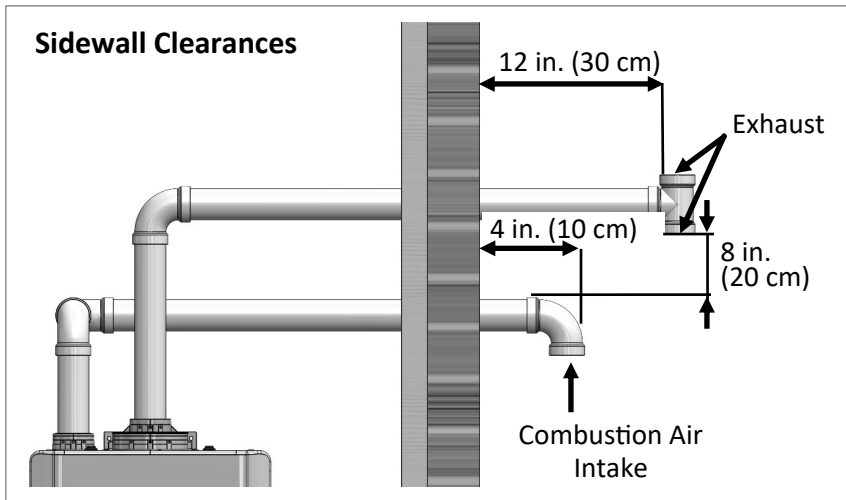

Figure 27

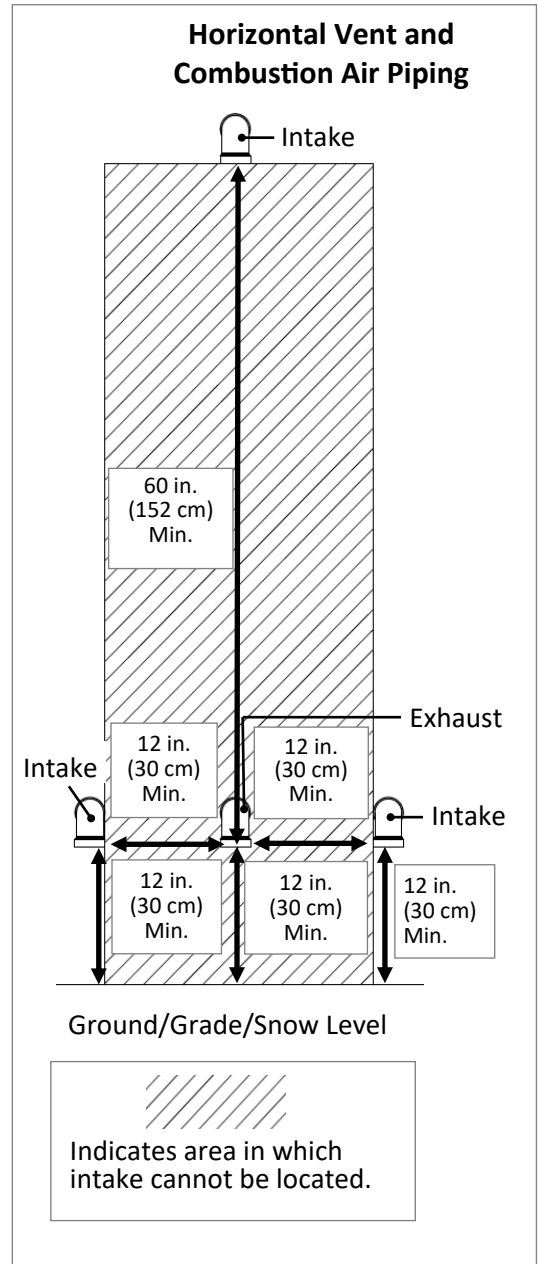

Figure 28

Twin Pipe: Maximum Equivalent Vent Length

Vent length includes the additional venting, fittings and terminations.

Table 20

Vent Sizes:	<ul style="list-style-type: none"> 2 in. PVC 2 in. (60 mm) PP 	<ul style="list-style-type: none"> 3 in. PVC 3 in. (80 mm) PP
Vent Lengths:	75 ft (23 m)	160 ft (49 m)
<ul style="list-style-type: none"> 45° elbow is equivalent to 3 ft (1 m) 90° elbow is equivalent to 6 ft (2 m) 		

Table 21

ACCEPTABLE	ACCEPTABLE	NOT ACCEPTABLE
90° Elbows, Long Sweep	90° Elbows, Short Sweep	90° Elbows, Close Turn

Twin Pipe: Installation Instructions

This boiler is equipped with a 2 in. PVC pipe connection. With the use of a pipe reducer, installers can use a 3 in. pipe for the combustion air and exhaust.

WARNING

DO NOT apply PVC glues, solvents, or cleaners to the boiler's combustion air or exhaust gasket connections. Failure to correctly assemble the components according to these instructions may result in property damage, personal injury, or death.

1. Remove and discard the screw from the combustion air vent connection.

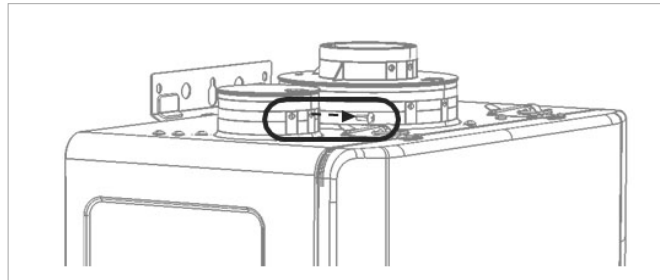

Figure 29

2. Remove and discard the combustion air vent cap.

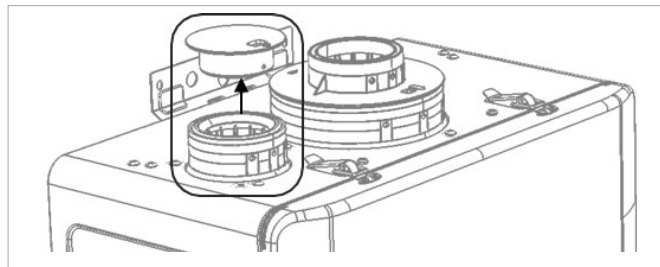

Figure 30

3. Install the combustion air vent pipe. Ensure it is properly seated.
Secure the combustion air vent pipe to the combustion air vent connection with the supplied screw.

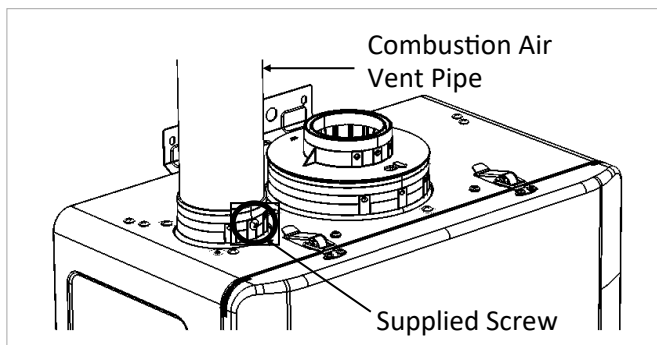

Figure 31

4. Install the exhaust vent pipe. Ensure it is properly seated.
Secure the exhaust vent pipe to the exhaust adapter ring with the supplied screw.

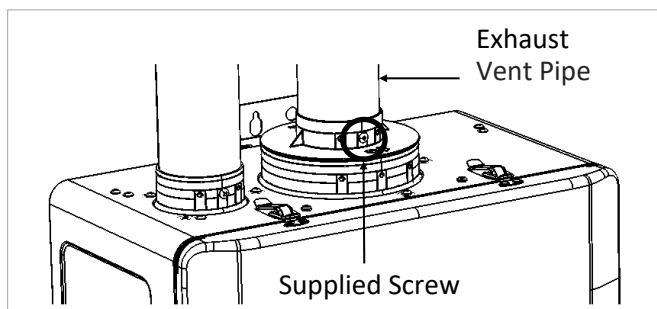

Figure 32





Twin Pipe: Example Vent Applications

Slope horizontal exhaust 1/4 in. per foot towards the boiler. DO NOT slope combustion air pipe towards the boiler.

CAUTION

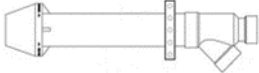
Rinnai cautions against installing the boiler in applications with venting in different pressure planes. It is possible to have poor performance with this installation.

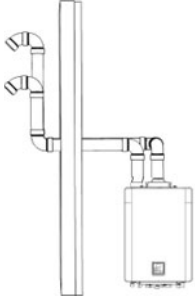
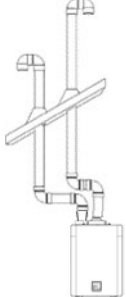
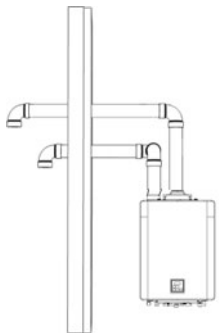
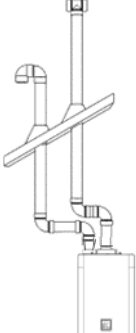
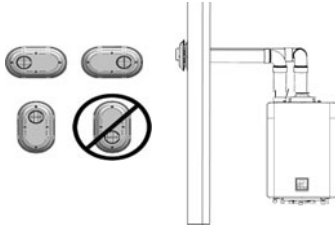
Table 22

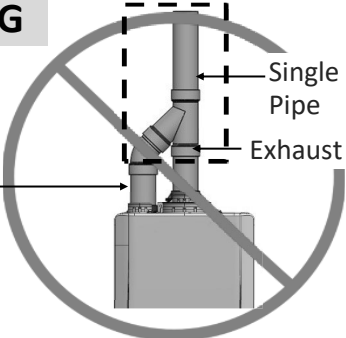
<p>This configuration requires the use of a Concentric Vent Termination</p> <p>2 in. or 3 in. PVC/ CPVC IPEX/ Royal Concentric Side Wall Termination Configuration</p> 	<p>This configuration requires the use of a Concentric Vent Termination</p> <p>2 in. or 3 in. PVC/CPVC IPEX/ Royal Concentric Vertical Termination Configuration</p> 
<p>2 in. or 3 in. Schedule 40 PVC/CPVC or ABS Snorkel Termination Configuration</p> 	<p>2 in. or 3 in. Schedule 40 PVC/CPVC or ABS Standard upside down "U" Vertical Termination Configuration</p> 
<p>2 in. or 3 in. Schedule 40 PVC/CPVC or ABS Elbow or Tee Side Wall Termination Configuration</p> 	<p>2 in. or 3 in. Schedule 40 PVC/CPVC or ABS Tee Vertical Termination Configuration</p> 
<p>2 in. or 3 in. PVC Low Profile Termination Configuration</p> 	<p> WARNING</p> <p>Exhaust and combustion air MUST NOT be brought together into a single PVC pipe using a pipe fitting.</p>  <p>Single Pipe Exhaust Combustion Air</p>

5.5.5 Non-Direct Vent (Room Air)

Room Air: Termination Clearances

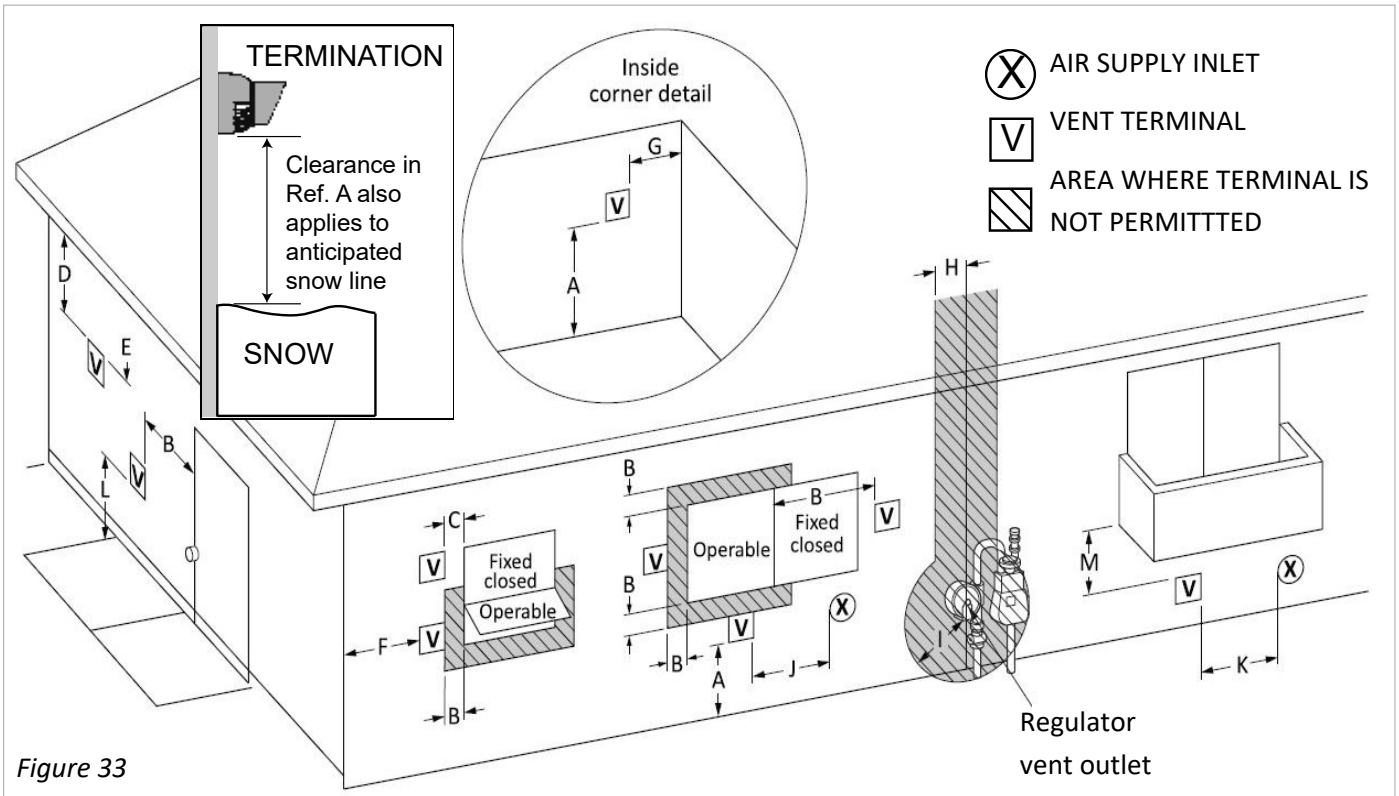

Figure 33

Table 23

Ref	Description	Canadian Installations (CSA B149.1)	U.S. Installations (ANSI Z223.1 /NFPA 54)
		Other than Direct Vent (Room Air)	Other than Direct Vent (Room Air)
A	Clearance above grade, veranda, porch, deck, or balcony	12 in. (30 cm)	12 in. (30 cm)
B	Clearance to window or door that may be opened	<ul style="list-style-type: none"> 6 in. (15 cm) for appliances $\leq 10,000$ Btu/hr 12 in. (30 cm) for appliances $> 10,000$ Btu/hr and $\leq 100,000$ Btu/hr 36 in. (91 cm) for appliances $> 100,000$ Btu/hr 	4 ft (1.2 m) below or to side of opening; 1 ft (300 mm) above opening
C	Clearance to permanently closed window	*	*
D	Vertical clearance to ventilated soffit, located above the terminal within a horizontal distance of 2 ft (61 cm) from the center line of the terminal	*	*
E	Clearance to unventilated soffit	*	*
F	Clearance to outside corner	*	*
G	Clearance to inside corner	*	*
H	Clearance to each side of center line extended above meter/regulator assembly	*	*
I	Clearance to service regulator vent outlet	Above a regulator within 3 ft (91 cm) horizontally of the vertical center line of the regulator vent outlet to a maximum vertical distance of 15 ft (4 m)	*
J	Clearance to non-mechanical air supply inlet to building or the combustion air inlet to any other appliance	36 in. (91 cm)	4 ft (1.2 m) below or to side of opening; 1 ft (300 mm) above opening
K	Clearance to a mechanical air supply inlet	6 ft (1.83 m)	3 ft (91 cm) above if within 10 ft (3 m) horizontally
L	Clearance above paved sidewalk or paved driveway located on public property	7 ft (2.13 m) [1]	7 ft (2.13 m)
M	Clearance under veranda, porch, deck, or balcony	12 in. (30 cm) [2]	*

Table 24

Clearance to opposite wall is 24 in. (60 cm).	
[1] A vent shall not terminate directly above a sidewalk or paved driveway that is located between two single family dwellings and serves both dwellings.	* Clearances are in accordance with local installation codes and the requirements of the gas supplier.
[2] Permitted only if veranda, porch, deck, or balcony is fully open on a minimum	

Room Air Vertical Termination of Multiple Boilers

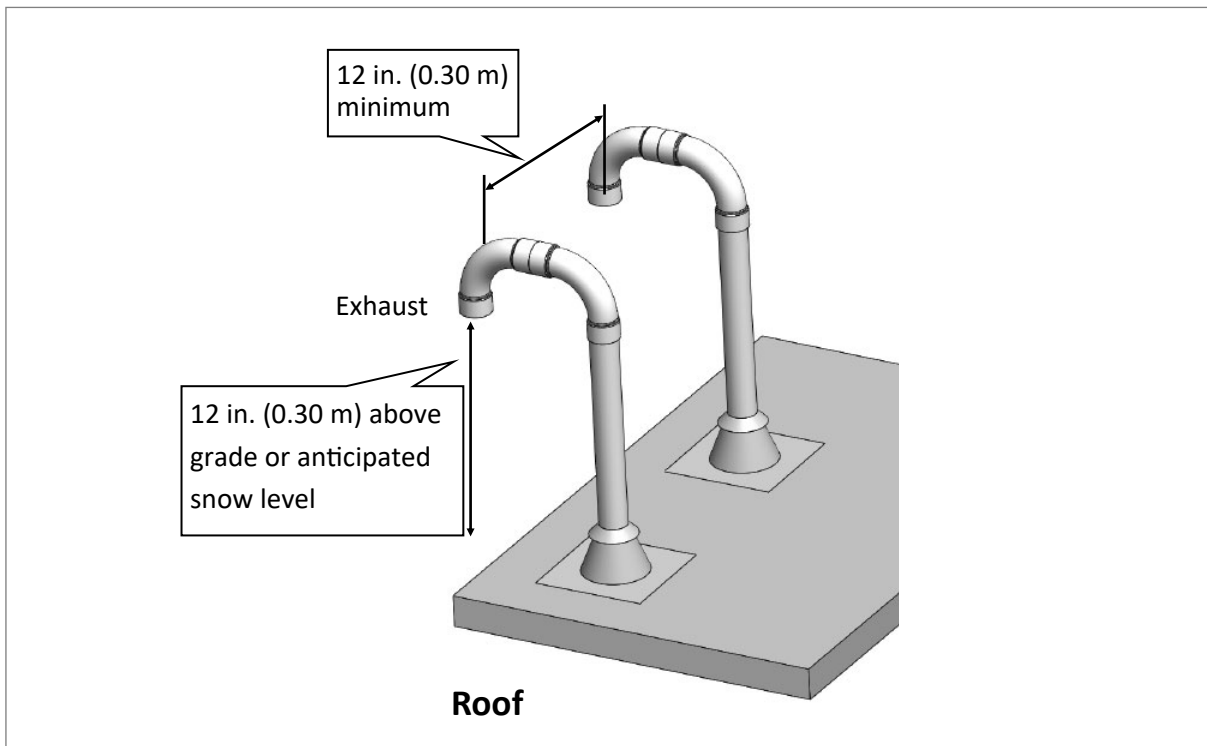

Figure 34

Exhaust Termination Clearances for Internal (Indoor) Room Air Applications

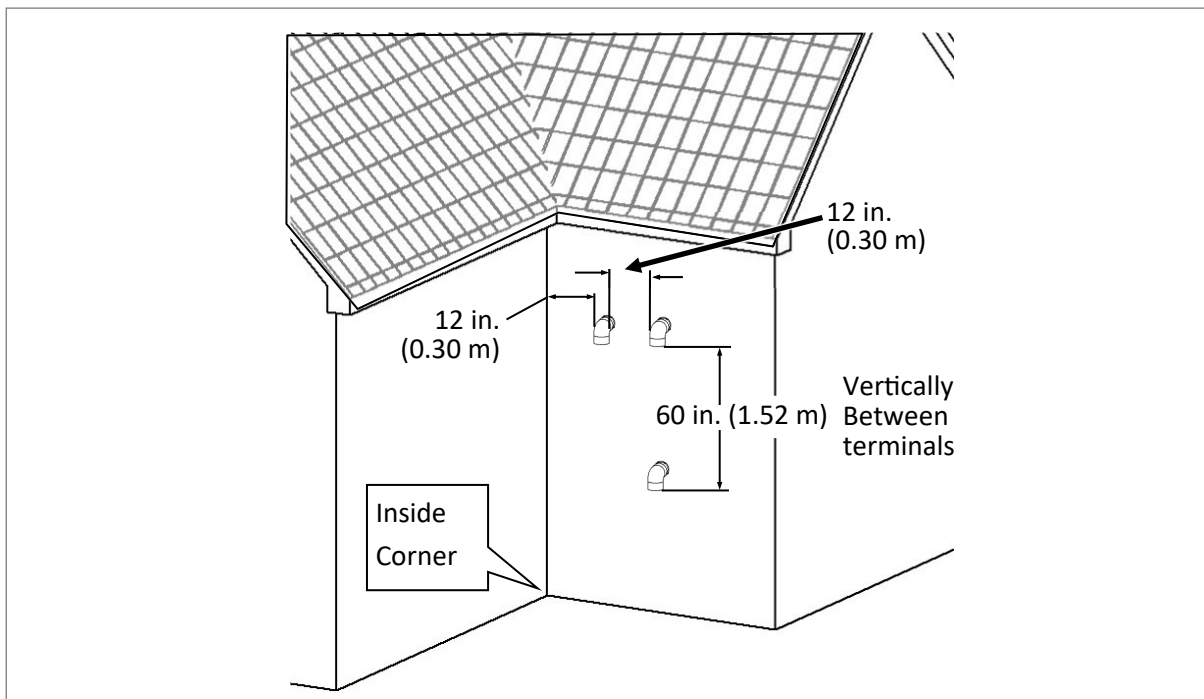

Figure 35

➔ IMPORTANT

- Installation of Room Air must use listed Category IV venting.
- All terminations (horizontal and/or vertical) must terminate 12 in. above grade or anticipated snow level.



Room Air: Maximum Equivalent Vent Length

Table 25

Vent Sizes	<ul style="list-style-type: none"> • 2 in. PVC • 2 in. (60 mm) PP 	<ul style="list-style-type: none"> • 3 in. PVC • 3 in. (80 mm) PP 	Ubbink Rolux® Flexible Vent System: <ul style="list-style-type: none"> • 2 in. (60 mm) PP
Vent Lengths	75 ft (23 m)	160 ft (49 m)	50 ft (15 m)
<ul style="list-style-type: none"> • 45° elbow is equivalent to 3 ft (1 m) • 90° elbow is equivalent to 6 ft (2 m) 			

Vent length includes the additional venting, fittings and terminations.

Table 26

ACCEPTABLE	ACCEPTABLE	NOT ACCEPTABLE
90° Elbows, Long Sweep	90° Elbows, Short Sweep	90° Elbows, Close Turn
		

Room Air: Combustion Air

WARNING

- This boiler requires adequate combustion air for ventilation and dilution of flue gases. Failure to provide adequate combustion air can result in unit failure, fire, explosion, serious bodily injury or death. Use the following methods to ensure adequate combustion air is available for correct and safe operation of this boiler.
- Direct Venting is recommended in unusually tight buildings or in installation locations subject to significant negative air pressure.

IMPORTANT

Combustion air must be free of corrosive chemicals. Do not provide combustion air from corrosive environments. Appliance failure due to corrosive air is not covered by warranty.

For applications containing corrosive indoor air, this appliance must be installed as direct vent. DO NOT use room air in applications where combustion air contains acid forming chemicals such as sulfur, fluorine and chlorine. These chemicals have been found to cause rapid damage and decay and can become toxic when used as combustion air in gas appliances. Such chemicals can be found in, but not limited to bleach, ammonia, cat litter, aerosol sprays, cleaning solvents, varnish, paint and air fresheners. Do not store these products or similar products in the vicinity of this boiler.

Unconfined Space

An unconfined space is defined in *National Fuel Gas Code, ANSI Z223.1/NFPA 54* as "a space whose volume is not less than 50 cubic feet per 1000 Btu/hr (4.8 m³ per kW per hour) of the aggregate input rating of all appliances installed in that space. Rooms communicating directly with the space in which the appliances are installed, through openings not furnished with doors, are considered a part of the unconfined space." If the "unconfined space" containing the appliance(s) is in a building with tight construction, additional outside air may be required for proper operation. Outside air openings should be sized the same as for a confined space.

Confined Space

A confined space is defined in the *National Fuel Gas Code, ANSI Z223.1/NFPA 54* as "a space whose volume is less than 50 cubic feet per 1000 Btu/hr (4.8 m³ per kW per hour) of the aggregate input rating of all appliances installed in that space." Examples include a small room, closet, alcove, utility room, etc. A confined space must have two combustion air openings. Size the combustion air openings based on the Btu input for all gas utilization equipment in the space and the method by which combustion air is supplied.

Using Indoor Air For Combustion

When using air from other room(s) in the building, the total volume of the room(s) must be of adequate volume (greater than 50 cubic feet per 1000 Btu/hr). Combustion air openings between joining rooms must have at least 1 square inch of free area for each 1000 Btu/hr, but not less than 100 square inches each.

Using Outdoor Air For Combustion

Outdoor air can be provided to a confined space through two permanent openings, one commencing within 12 in. (0.30 m) of the top and one commencing within 12 in. (0.30 m) of the bottom, of the confined space. The openings shall communicate to the outside by one of two ways. When communicating directly with the outdoors through horizontal ducts, each opening shall have a minimum free area of 1 in²/2000 Btu/hr (1100 mm²/kW) of total input rating of all appliances in the confined space.

Note: If ducts are used, the cross sectional area of the duct must be greater than or equal to the required free area of the openings to which they are connected.

Louvers and Grills

When sizing the permanent opening consideration must be taken for the design of the louvers or grills to maintain the required free area required for all gas utilizing equipment in the space. If the free area of the louver or grill design is not available, assume wood louvers will have 25% free area and metal louvers or grills will have 75% free area. Under no circumstance should the louver, grill or screen have openings smaller than 1/4 in.

Examples: Wood: 10 in. x 12 in. x 0.25 = 30 in.²

Metal: 10 in. x 12 in. x 0.75 = 90 in.²

Location

To maintain proper circulation of combustion air two permanent openings (one upper, one lower) must be positioned in confined spaces. The upper shall be within 12 in. (0.30 m) of the top of the confined space and the lower opening shall be within 12 in. (0.30 m) of the bottom of the confined space. Openings must be positioned as to never be obstructed.

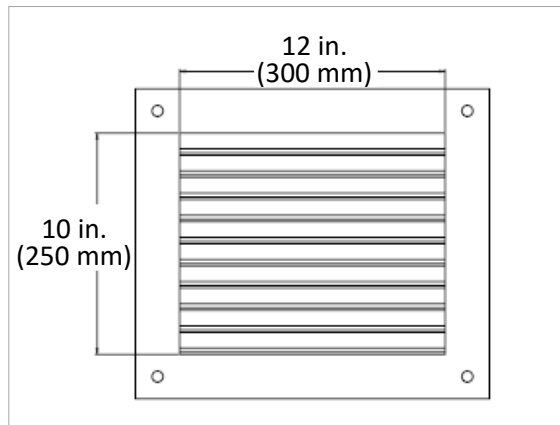

Figure 36



IMPORTANT

Combustion air provided to the appliance should not be taken from any area of the structure that may produce a negative pressure (i.e. exhaust fans, powered ventilation fans).



WARNING

To prevent possible personal injury or death due to asphyxiation, common venting with other manufacturer's induced draft appliances is not allowed.

Checklist for Combustion Air and Venting Requirements

<input type="checkbox"/>	Verify all combustion air opening sizes are correct.
<input type="checkbox"/>	Ensure that the Combustion Air Requirements are followed that will provide sufficient combustion air for the appliance.
<input type="checkbox"/>	DO NOT use room air for combustion in applications where the indoor air is corrosive.
<input type="checkbox"/>	Verify that adequate combustion air is available for all appliances installed in the space.
<input type="checkbox"/>	Installation complies with National Fuel Gas Code, ANSI Z223.1/NFPA 54 as well as local and state regulations therein.

Room Air: Installation Instructions

1. Remove and discard screw from combustion air vent connection.

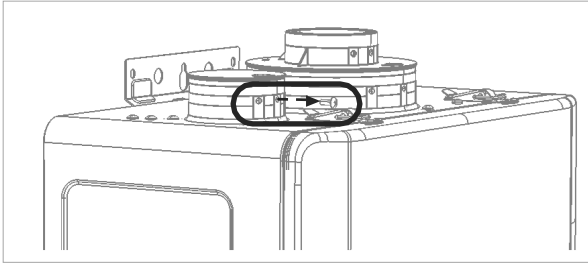

Figure 37

2. Remove and discard the combustion air vent cap.

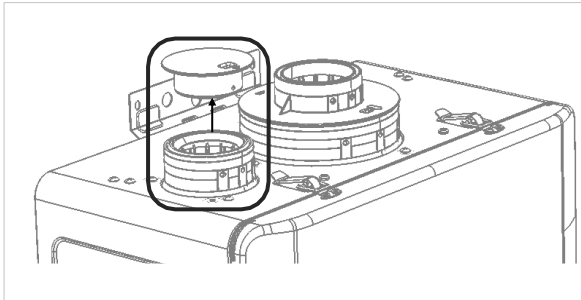

Figure 38

3. Install the combustion air vent pipe. Ensure it is properly seated.
Secure the combustion air vent pipe to the combustion air vent connection with the supplied screw.

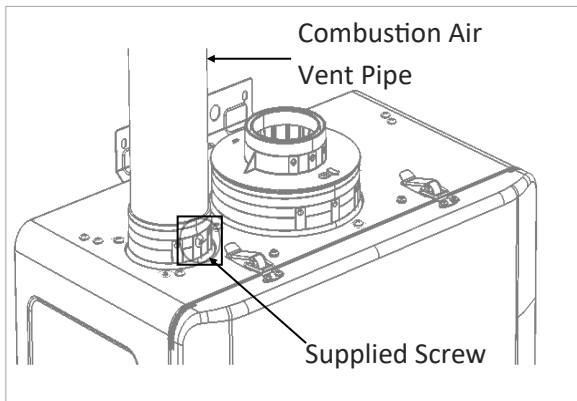

Figure 39

4. Place the vent screen or room air screen inside elbow and secure with the supplied screw. Use the room air screen for environments where room air is dusty.

Notes:

- 2 in vent screen supplied with boiler.
- Room air screen is available as an accessory.

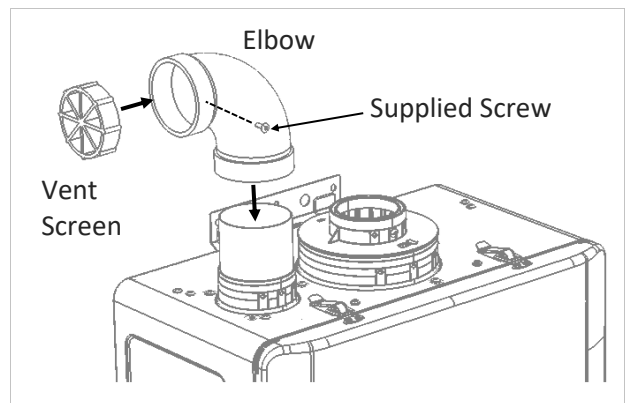

Figure 40

5. Install the exhaust vent pipe. Ensure it is properly seated.

Secure the exhaust vent pipe to the exhaust adapter ring with the supplied screw.

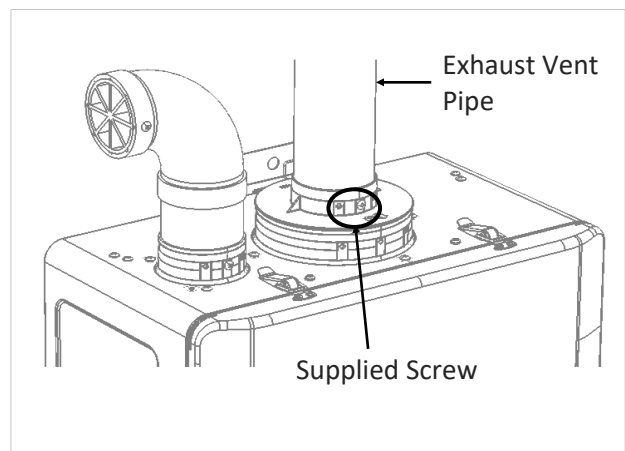

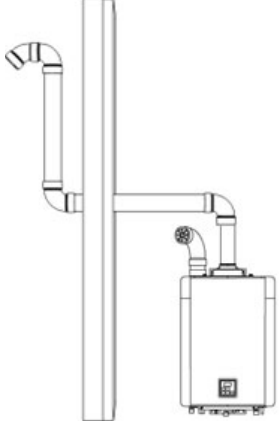

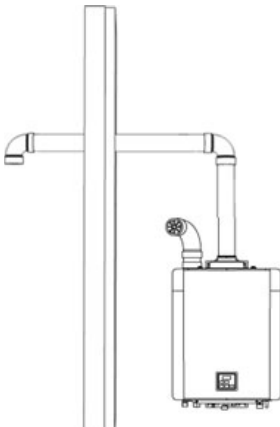

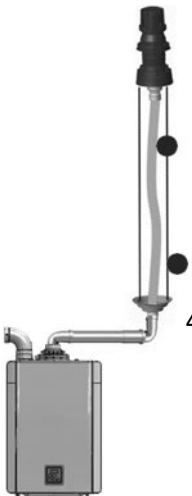

Figure 41

Room Air: Example Vent Applications

CAUTION

Rinnai cautions against installing the boiler in applications with venting in different pressure planes. It is possible to have poor performance with this installation.

Table 27

<p>2 in. or 3 in. Schedule 40 PVC/CPVC or ABS Snorkel Termination Configuration</p> 	<p>2 in. or 3 in. Schedule 40 PVC/CPVC or ABS Standard Upside Down "U" Vertical Termination configuration</p> 
<p>2 in. or 3 in. Schedule 40 PVC/CPVC or ABS Elbow or Tee Side Wall Termination Configuration</p> 	<p>2 in. or 3 in. Schedule 40 PVC/ CPVC or ABS Tee Vertical Termination Configuration</p> 
<p>Ubbink flexible venting approved for vertical non-direct vent (Room Air) applications only. Refer to the flex vent manual for further details.</p>  <p>PP Flex Venting</p>  <p>B-Vent Pipe 4 in. (102 mm)</p>	<p>Slope horizontal exhaust 1/4 in. per foot towards the boiler.</p>

Outdoor Vent Cap Application

The Rinnai RX Series Tankless Water Heater offers an outdoor vent cap as an accessory to enable outdoor installations. This is not an acceptable accessory for the I-Series Plus Condensing Boiler. The boiler is only approved to be installed indoors with appropriate venting to the outdoors.

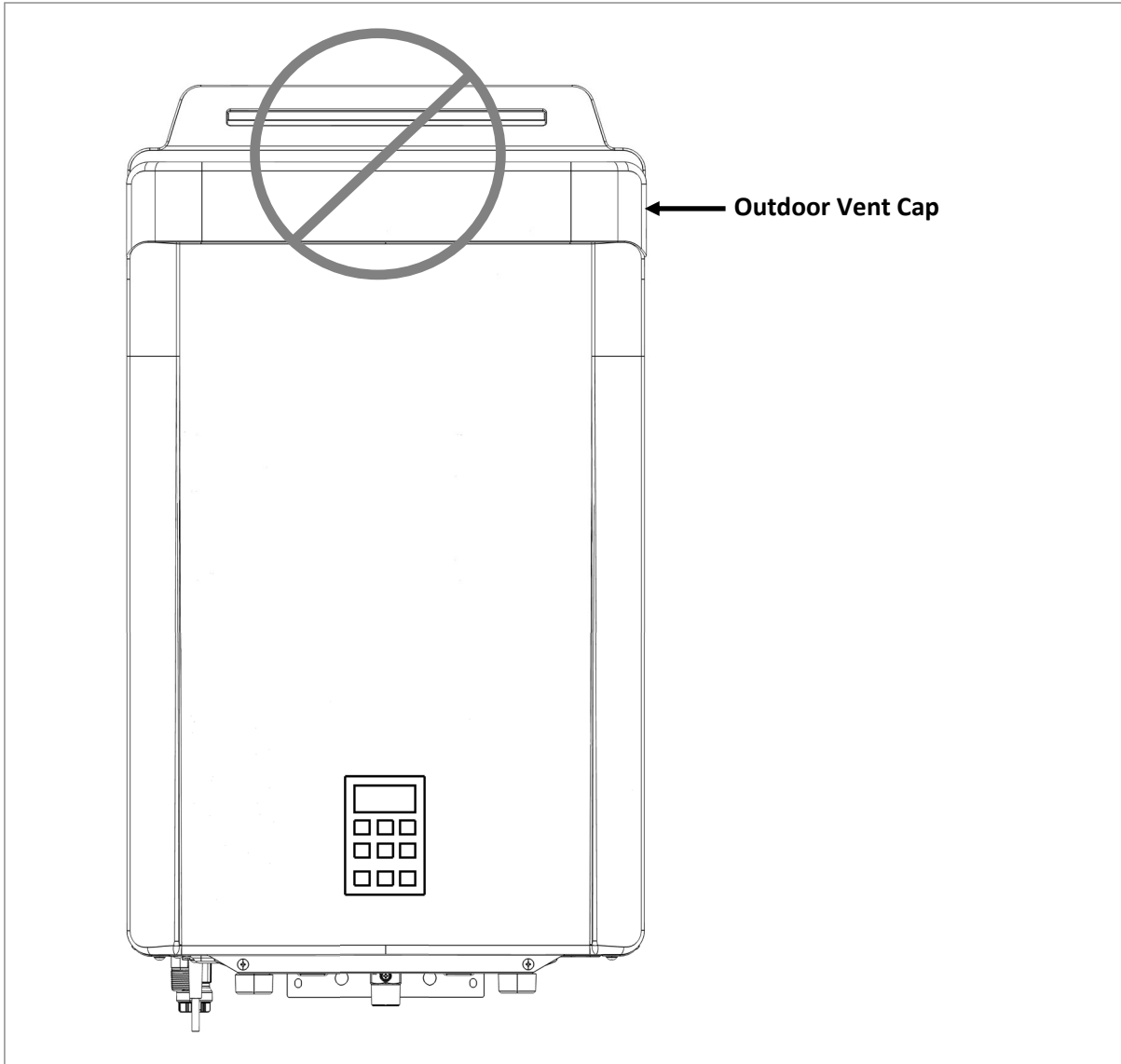

Figure 42

6. Gas Supply

Topics in this section

- Connect the Gas Supply
- Gas Operating Instructions
- Gas Pipe Sizing Reference Tables

6.1 Connect the Gas Supply

WARNING

- A licensed professional must install the gas supply.
- Turn off 120V power supply.
- Turn off the gas.
- Gas is flammable. Do not smoke or provide other ignition sources while working with gas.
- Do not turn on the boiler or gas until all fumes are gone.
- Confirm the gas type before connecting. Failure to install correct gas type may result in injury or damage to the unit.

IMPORTANT

- The boiler shall be installed such that the gas ignition system components are protected from water (dripping, spraying, rain, etc.) during appliance operation and service (circulator replacement, condensate trap, control replacement, etc.).
- A sediment trap must be provided upstream of the gas controls.
- A manual gas shutoff valve between the gas supply and the boiler must be installed.

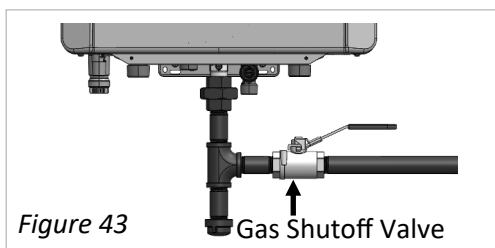

1. Check the type of gas and gas supply pressure before connecting the boiler. If the boiler is not of the gas type that the building is supplied with, converting the gas type of the boiler is necessary. A gas conversion kit is included with the boiler. Refer to section “14.4 Gas Conversion” in the Appendix for gas conversion instructions.
2. Check the gas supply pressure immediately upstream at a location provided by the gas company. Supplied gas pressure must be within the limits shown in section “3.4 Specifications” with all gas appliances operating.
3. Before placing the appliance in operation, all joints including the heater must be checked for gas tightness by means of soap, gas leak detector solution, or an equivalent nonflammable solution, as applicable. Since some leak test solutions, including soap and water, may cause corrosion or stress cracking, the piping shall be rinsed with water after testing, unless it has been determined that the leak test solution is non-corrosive.
4. Use approved and appropriately sized connectors to connect the boiler to the gas line. Purge the gas line of any debris before connection to the boiler.
5. Any compound used on the threaded joint of the gas piping shall be a type that resists the action of liquefied petroleum gas (Propane/LPG).
6. The gas supply line shall be gas tight, sized, and so installed as to provide a supply of gas sufficient to meet the maximum demand of the heater and all other gas consuming appliances at the location without loss of pressure. If in doubt about the size of the gas line, refer to section “6.3 Gas Pipe Sizing Reference Tables.”
7. Perform a leak and pressure test prior to operating the boiler. If a leak is detected, do not operate the boiler until the leak is repaired.

6.2 Gas Operating Instructions

FOR YOUR SAFETY READ BEFORE OPERATING



WARNING: If you do not follow these instructions EXACTLY, a fire or explosion may result causing property damage, personal injury or loss of life.

- A. This appliance does not have a pilot. It is equipped with an ignition device which automatically lights the burner. Do not try to light the burner by hand.
- B. BEFORE OPERATING smell all around the appliance area for gas. Be sure to smell next to the floor because some gas is heavier than air and will settle on the floor.

WHAT TO DO IF YOU SMELL GAS:

- DO NOT try to light any appliance.
 - DO NOT touch any electric switch; DO NOT use any phone in your building.
 - Immediately call your gas supplier from a neighbor's phone. Follow the gas supplier's instructions.
 - If you cannot reach your gas supplier, call the fire department.
- C. Use only your hand to turn the gas control valve. Never use tools. If the gas control valve will not turn by hand, don't try to repair it, call a qualified service technician. Force or attempted repair may result in a fire or explosion.
 - D. Do not use this appliance if any part has been under water. Immediately call a qualified service technician to inspect the appliance and to replace any part of the control system and any gas control which has been under water.

OPERATING INSTRUCTIONS

1. STOP! Read the safety information above on this label.
2. Set the temperature controller to lowest setting.
3. Turn off all electric power to the appliance.
4. This appliance does not have a pilot. It is equipped with a direct ignition device which automatically lights the burner. DO NOT try to light the burner by hand.
5. Turn the manual gas control valve located at gas inlet of appliance clockwise  to the OFF position.
6. Wait five (5) minutes to clear out any gas. Then smell for gas, including near the floor. If you smell gas, STOP! Follow "B" in the safety information above on this label. If you don't smell gas, go to the next step.
7. Turn the manual gas control valve located at gas inlet of appliance counter  clockwise to the ON position.
8. Turn on all electric power to the appliance.
9. Set the temperature controller to desired setting.
10. If the appliance will not operate, follow the instructions "To Turn Off Gas To Appliance" and call your service technician or gas supplier.

TO TURN OFF GAS TO APPLIANCE

1. Set the temperature controller to the lowest setting.
2. Turn off all electric power to the appliance if service is to be performed.
3. Turn the manual gas control valve located at gas inlet of appliance clockwise  to the OFF position.

6.3 Gas Pipe Sizing Reference Tables

The gas supply must be capable of handling the entire gas load required at the location. Gas line sizing is based on gas type, the pressure drop in the system, the gas pressure supplied, and gas line type. For gas pipe sizing, refer to the National Fuel Gas Code, ANSI Z223.1/NFPA 54, or the Natural Gas and Propane Installation Code, CSA B149.1

For some tables, you will need to determine the cubic feet per hour of gas required by dividing the gas input by the heating value of the gas (available from the local gas company). The gas input needs to include all gas products at the location and the maximum Btu usage at full load when all gas products are in use.

Use the table for your gas type and pipe type to find the pipe size required. The pipe size must be able to provide the required cubic feet per hour of gas or the required Btu/hr.

The information below is provided as an example. The appropriate table from the applicable code must be used.

Natural Gas

Table 28

Pressure Drop 0.5 in. w.c.				
Information in table obtained from NFPA 54, ANSI Z223.1.	Schedule 40 Metallic Pipe			
	Inlet Pressure:		Less than 2 PSI	
	Specific Gravity:		0.60	
	Nominal Pipe Size (in.)			
	1/2	3/4	1	1 1/4
Length in ft (meters)	Capacity in Cubic Feet of Gas per Hour			
10 (3)	172	360	678	1,390
20 (6)	118	247	466	957
30 (9)	95	199	374	768
40 (12)	81	170	320	657
50 (15)	72	151	284	583
60 (18)	65	137	257	528
70 (21)	60	126	237	486
80 (24)	56	117	220	452
90 (27)	52	110	207	424
100 (30)	50	104	195	400

GAS PIPE SIZING CALCULATION WORKSHEET

Instructions: Enter values in empty boxes.

Rinnai Model Gas Input:

A Btu/hr

Additional Appliance Total Gas Input:

B Btu/hr

Heating Value of Gas:

C Btu/ft³

Cubic Feet Per Hour (CFH):

$$(CFH) = \frac{A + B}{C}$$

(CFH) =

ANSWER: CFH = FT³/HR

EXAMPLE

Rinnai Model Gas Input:

A Btu/hr

Additional Appliance Total Gas Input:

B Btu/hr

Heating Value of Gas:

C Btu/ft³

Cubic Feet Per Hour (CFH):

$$(CFH) = \frac{A + B}{C}$$

(CFH) =

ANSWER:

CFH = FT³/HR

For this example, the pipe diameter must be at least 3/4 in. pipe size and 10 ft (3 m) in length.

Natural Gas

Table 29

Pressure Drop 3.0 in. w.c.																																																																
Intended use: Initial supply pressure of 8.0 in. w.c. or greater.		Schedule 40 Metallic Pipe																																																														
		Inlet Pressure:	Less than 2 PSI																																																													
Information in table obtained from NFPA 54, ANSI Z223.1.		Specific Gravity:																																																														
		0.6																																																														
Nominal Pipe Size (in.)																																																																
<table border="1"> <thead> <tr> <th></th> <th>1/2</th> <th>3/4</th> <th>1</th> <th>1 1/4</th> </tr> </thead> <tbody> <tr> <td>Length in ft (meters)</td> <td colspan="4">Capacity in Cubic Feet of Gas per Hour</td> </tr> <tr> <td>10 (3)</td> <td>454</td> <td>949</td> <td>1,790</td> <td>3,670</td> </tr> <tr> <td>20 (6)</td> <td>312</td> <td>652</td> <td>1,230</td> <td>2,520</td> </tr> <tr> <td>30 (9)</td> <td>250</td> <td>524</td> <td>986</td> <td>2,030</td> </tr> <tr> <td>40 (12)</td> <td>214</td> <td>448</td> <td>844</td> <td>1,730</td> </tr> <tr> <td>50 (15)</td> <td>190</td> <td>397</td> <td>748</td> <td>1,540</td> </tr> <tr> <td>60 (18)</td> <td>172</td> <td>360</td> <td>678</td> <td>1,390</td> </tr> <tr> <td>70 (21)</td> <td>158</td> <td>331</td> <td>624</td> <td>1,280</td> </tr> <tr> <td>80 (24)</td> <td>147</td> <td>308</td> <td>580</td> <td>1,190</td> </tr> <tr> <td>90 (27)</td> <td>138</td> <td>289</td> <td>544</td> <td>1,120</td> </tr> <tr> <td>100 (30)</td> <td>131</td> <td>273</td> <td>514</td> <td>1,060</td> </tr> </tbody> </table>						1/2	3/4	1	1 1/4	Length in ft (meters)	Capacity in Cubic Feet of Gas per Hour				10 (3)	454	949	1,790	3,670	20 (6)	312	652	1,230	2,520	30 (9)	250	524	986	2,030	40 (12)	214	448	844	1,730	50 (15)	190	397	748	1,540	60 (18)	172	360	678	1,390	70 (21)	158	331	624	1,280	80 (24)	147	308	580	1,190	90 (27)	138	289	544	1,120	100 (30)	131	273	514	1,060
	1/2	3/4	1	1 1/4																																																												
Length in ft (meters)	Capacity in Cubic Feet of Gas per Hour																																																															
10 (3)	454	949	1,790	3,670																																																												
20 (6)	312	652	1,230	2,520																																																												
30 (9)	250	524	986	2,030																																																												
40 (12)	214	448	844	1,730																																																												
50 (15)	190	397	748	1,540																																																												
60 (18)	172	360	678	1,390																																																												
70 (21)	158	331	624	1,280																																																												
80 (24)	147	308	580	1,190																																																												
90 (27)	138	289	544	1,120																																																												
100 (30)	131	273	514	1,060																																																												

Propane (Undiluted)

Table 30

Pressure Drop 0.5 in. w.c.																																																						
Information in table obtained from NFPA 54, ANSI Z223.1.		Schedule 40 Metallic Pipe																																																				
		Inlet Pressure:	11 in. w.c.																																																			
		Specific Gravity:																																																				
		1.50																																																				
Nominal Inside Pipe Size (in.)																																																						
<table border="1"> <thead> <tr> <th></th> <th>1/2</th> <th>3/4</th> <th>1</th> <th>1 1/4</th> </tr> </thead> <tbody> <tr> <td>Length in ft (meters)</td> <td colspan="4">Capacity in Thousands of Btu/hr</td> </tr> <tr> <td>10 (3)</td> <td>291</td> <td>608</td> <td>1,150</td> <td>2,350</td> </tr> <tr> <td>20 (6)</td> <td>200</td> <td>418</td> <td>787</td> <td>1,620</td> </tr> <tr> <td>30 (9)</td> <td>160</td> <td>336</td> <td>632</td> <td>1,300</td> </tr> <tr> <td>40 (12)</td> <td>137</td> <td>287</td> <td>541</td> <td>1,110</td> </tr> <tr> <td>50 (15)</td> <td>122</td> <td>255</td> <td>480</td> <td>985</td> </tr> <tr> <td>60 (18)</td> <td>110</td> <td>231</td> <td>434</td> <td>892</td> </tr> <tr> <td>80 (24)</td> <td>101</td> <td>212</td> <td>400</td> <td>821</td> </tr> <tr> <td>100 (30)</td> <td>94</td> <td>197</td> <td>372</td> <td>763</td> </tr> </tbody> </table>						1/2	3/4	1	1 1/4	Length in ft (meters)	Capacity in Thousands of Btu/hr				10 (3)	291	608	1,150	2,350	20 (6)	200	418	787	1,620	30 (9)	160	336	632	1,300	40 (12)	137	287	541	1,110	50 (15)	122	255	480	985	60 (18)	110	231	434	892	80 (24)	101	212	400	821	100 (30)	94	197	372	763
	1/2	3/4	1	1 1/4																																																		
Length in ft (meters)	Capacity in Thousands of Btu/hr																																																					
10 (3)	291	608	1,150	2,350																																																		
20 (6)	200	418	787	1,620																																																		
30 (9)	160	336	632	1,300																																																		
40 (12)	137	287	541	1,110																																																		
50 (15)	122	255	480	985																																																		
60 (18)	110	231	434	892																																																		
80 (24)	101	212	400	821																																																		
100 (30)	94	197	372	763																																																		

EXAMPLE
Rinnai Model Gas Input:

A Btu/hr

Additional Appliance total Gas Input:

B Btu/hr

Heating Value of Gas:

C Btu/ft³

Cubic Feet Per Hour (CFH):

$$(CFH) = \frac{A + B}{C}$$

$$(CFH) = \frac{199,000 + 65,000}{1,000}$$

ANSWER:

CFH = ft³/HR

For this example, the pipe diameter must be at least 1/2 in. nominal pipe size and 20 ft (6 m) in length.

EXAMPLE
Rinnai Model Gas Input:

A Btu/hr

Additional Appliance Total Gas Input:

B Btu/hr

Total Gas Input:

$$\text{Total Gas Input} = A + B$$

$$\text{Total Gas Input} = 199,000 + 65,000$$

ANSWER:

Total Gas Input = Btu/hr

For this example, the pipe diameter must be at least 1/2 in. nominal pipe size and 10 ft (3 m) in length.

7. CH System Piping

Topics in this section

- Guidelines
- Instructions
- Common CH Components
- Piping Diagram for a Basic CH System (With Hydraulic Separation)
- Hydraulic Separation
- Connect the Pressure Relief Valves
- Connect the Condensate Drain Line

7.1 Guidelines



IMPORTANT

Purge the heating system to remove all debris and air. Debris and air in the lines will damage the boiler.

- When removing the plastic sealing caps from the boiler connections, water may come out of the boiler due to live fire testing during manufacturing.
- The boiler, when used in connection with a refrigeration system, must be installed so the chilled medium is piped in parallel with the boiler with appropriate valves to prevent the chilled medium from entering the boiler.
- The boiler piping system of a hot water boiler connected to heating coils located in air handling units where they may be exposed to refrigerated air circulation must be equipped with flow control valves or other automatic means to prevent gravity circulation of the boiler water during the cooling cycle.
- Some installations with multiple zone valves may require a differential bypass, which will prevent excessively high flow rates through a single zone when the other zone valves are closed.

- It is required to include an air separator on the central heating supply of the system.
- Hydraulic separation with primary/secondary piping is required when connecting the water supply (see section “7.5 Hydraulic Separation” for more information).
- System piping should be insulated when freezing is a potential concern.
- All piping must comply with local, state, national or ASME code as appropriate.



CAUTION

The boiler may not be installed directly to a heating system where polybutylene or other oxygen permeable piping is used.

7.2 Instructions

To connect the water supply, follow the instructions below.

For standard installations, refer to the “Piping Diagram for Basic Central Heating Installation” in this chapter.



IMPORTANT

Water connections to the boiler should follow all state and local plumbing codes.

1. Plumb the heating return line to the heating return connection on the bottom of the boiler.

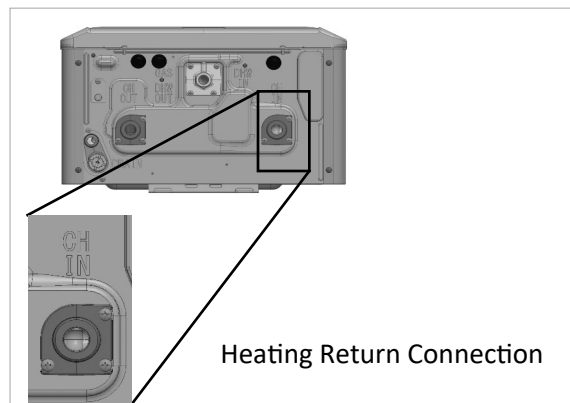

Figure 44

2. Plumb the heating supply line to the heating supply connection on the bottom of the boiler.

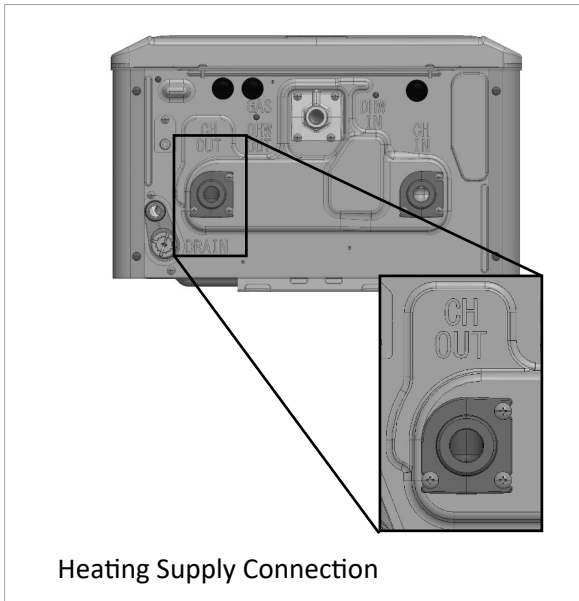

Figure 45

7.3 Common CH Components

Listed below are common components in a Central Heating system. Refer to the diagram on the next page.

- **Expansion Tank** - A properly sized expansion tank charged to 2 PSI (14 kPa) below the cold system pressure is required to limit pressure changes in the heating system. When replacing an expansion tank, consult the expansion tank manufacturer for sizing.
- **Air Separator** - An air separator is needed on the central heating supply side of the system to remove any air that may be present in the piping.
- **Pressure/Temperature Gauge** - The current pressure and temperature will alternately be displayed on the boiler control panel. A port for an external gauge is present in the Primary-Secondary Heating Kit accessory offered by Rinnai.
- **Pressure Relief Valve (PRV)** - A PRV located directly on the supply side of the boiler is required. The PRV must be 3/4 in. with at least 30 PSI (207 kPa) and a maximum of 45 PSI (310 kPa). A 30 PSI (207 kPa) PRV is supplied with the boiler. A port for the central heating PRV is present in the Primary-Secondary Heating Kit accessory offered by Rinnai.
- **Oxygen Elimination** - The boiler may only be installed in a pressurized closed-loop heating system, free of air and other impurities. If using oxygen permeable tubing in the central heating system, a plate heat exchanger is necessary to isolate the tubing and boiler.
- **Water Fill Valve** - Maintains proper water pressure in the central heating circuit.
- **Back Flow Preventer** - Use a back flow preventer in the filling circuit to the appliance as required by local code.
- **Low Water Cut Off (LWCO)** - This boiler has a factory-installed pressure sensor type LWCO. The boiler's internal LWCO is not serviceable or adjustable. Check your local codes to determine if a LWCO is required and if this device conforms to the local code. If a LWCO is required to be installed, the probe must be located higher than the minimum safe water level. When a LWCO is installed, it must be wired back to the appropriate terminal on the boiler PC Board.
- **Dirt Trap** - Protects the boiler from debris in the plumbing system.

CH System Common Components Diagram

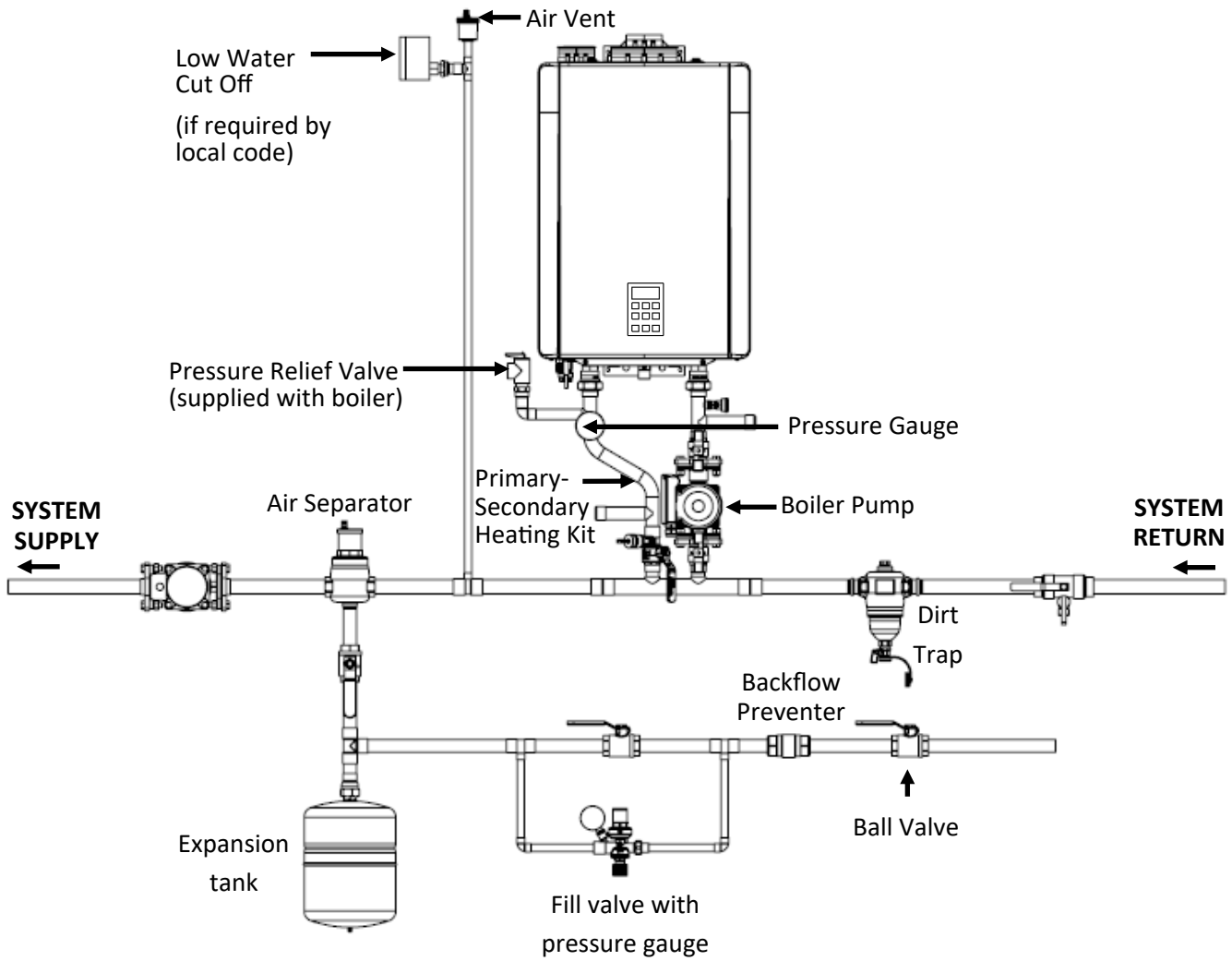

Figure 46

7.4 Piping Diagram for a Basic CH System (With Hydraulic Separation)

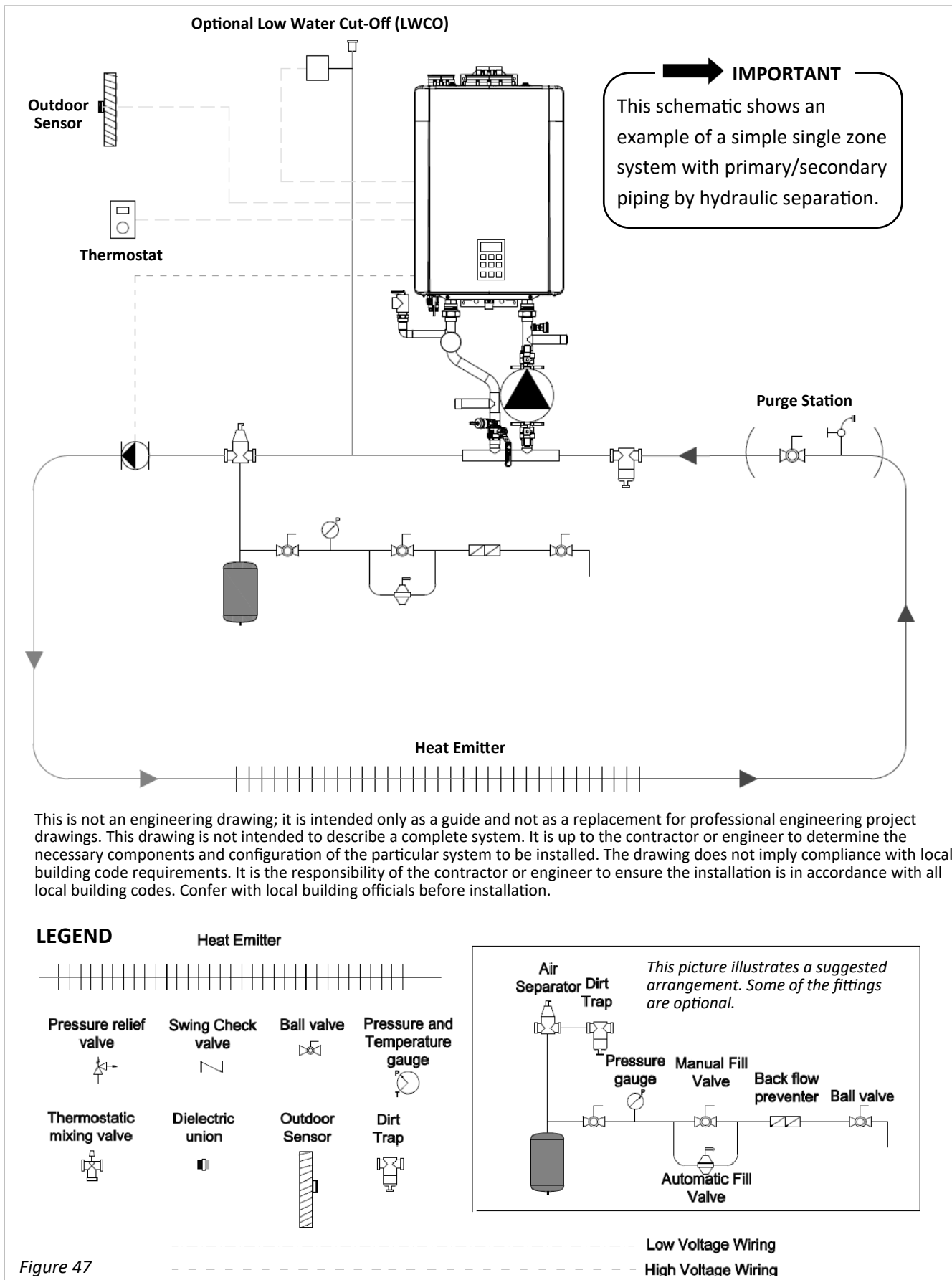

Figure 47

7.5 Hydraulic Separation

Rinnai requires the use of hydraulic separation between the boiler and central heating system. Hydraulic separation and primary/secondary piping allow two or more circulators in a hydronic system to operate independently, without interfering with flow in connecting piping circuits.

NOTE

When Rinnai I-Series Plus Boilers are in use with Rinnai air handlers, please reference the air handler Installation and Operation Manual for installation and performance details.

Examples of Hydraulic Separation

Closely spaced tees and low loss headers are common examples of hydraulic separators and are used to separate the boiler loop from the central heating loop.

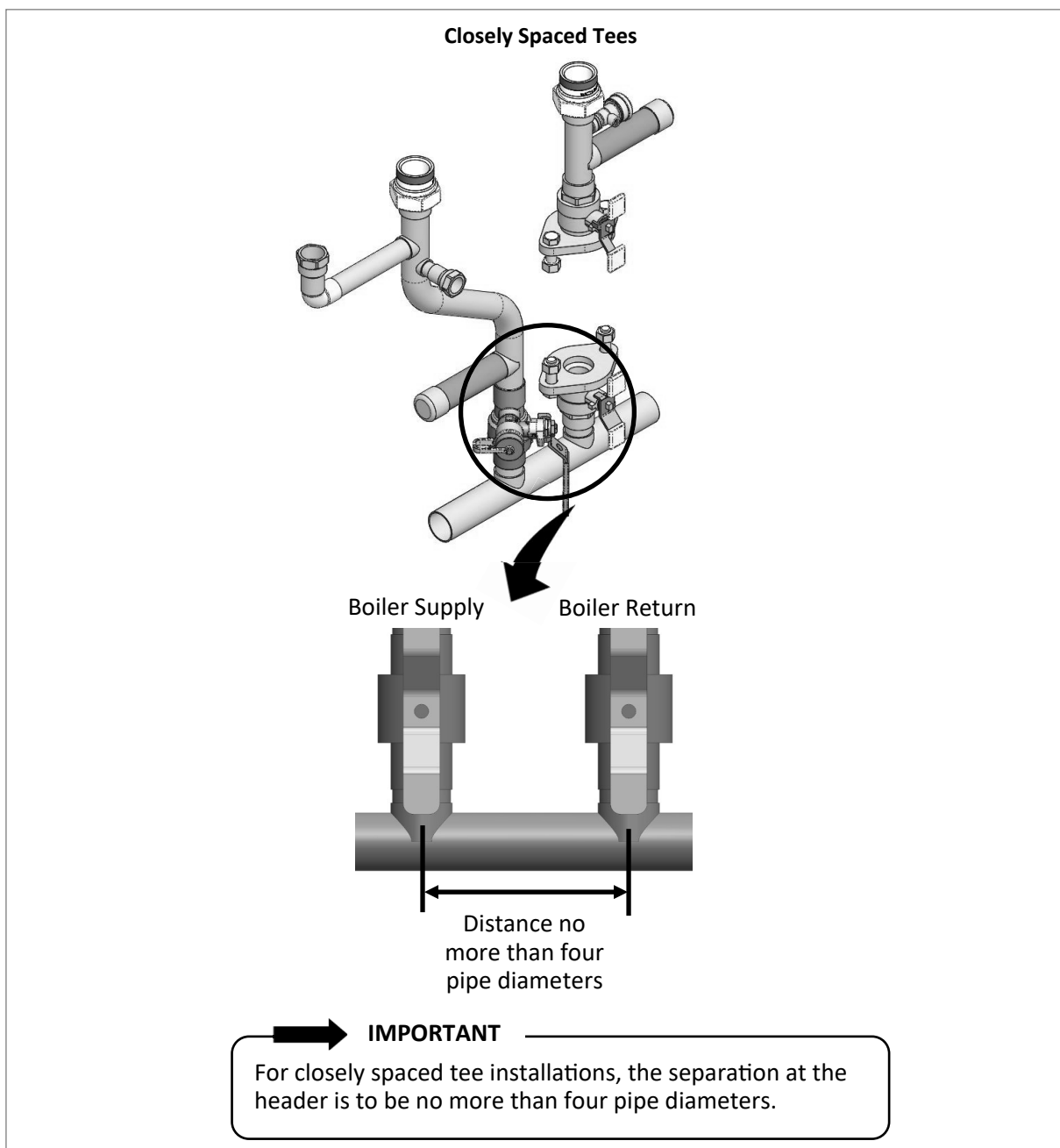

Figure 48

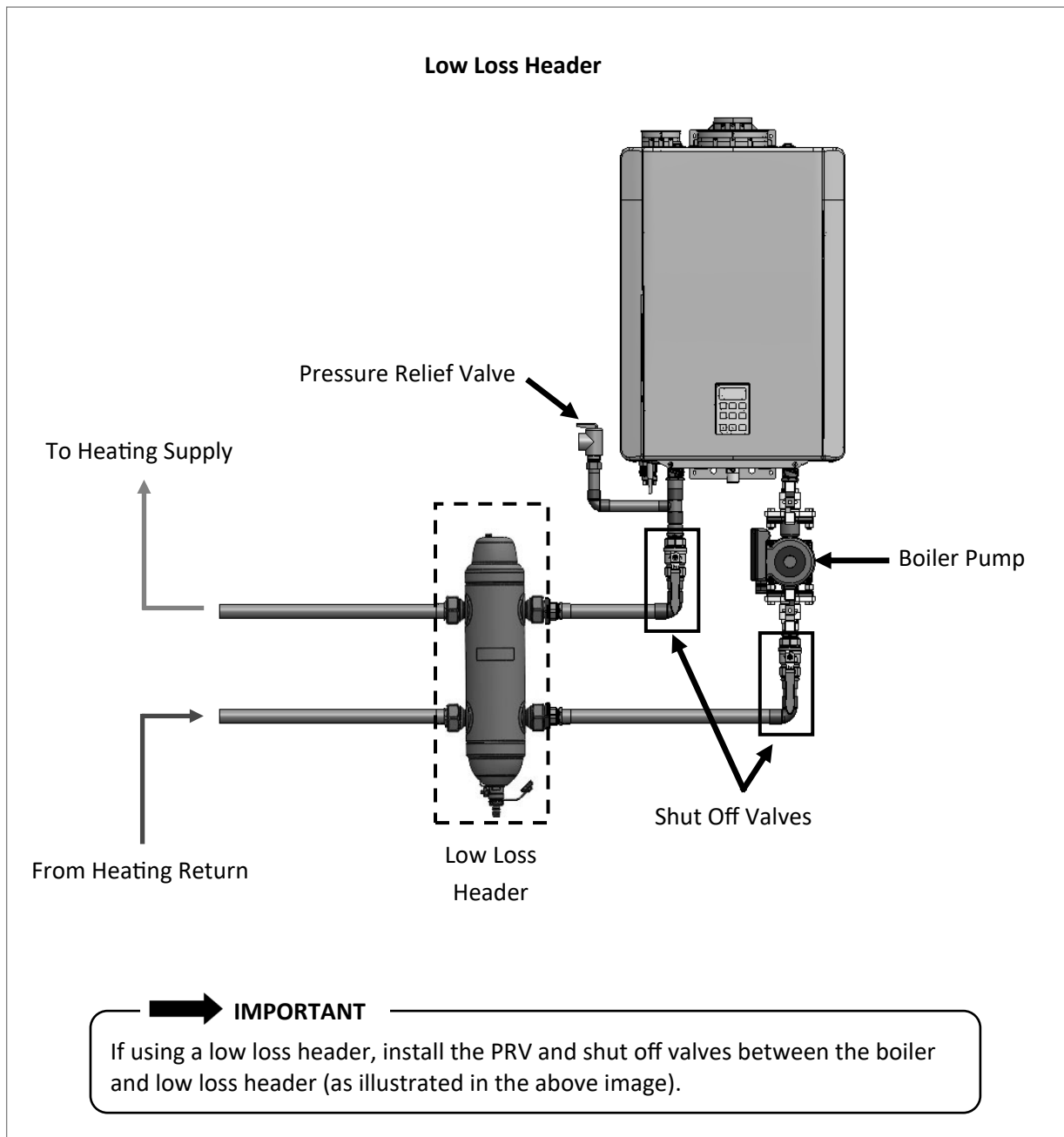

Figure 49

7.5.1 Pressure Drop and Water Flow Curve with Hydraulic Separation

The I-Series Heat-Only Boiler does not have an included a boiler pump. An external boiler pump must be installed and sized to the flow rate and pressure drop through the boiler, system piping, and system components. Larger systems, or systems with large pressure drops, should incorporate a form of hydraulic separation, such as closely spaced tees or a low loss header.

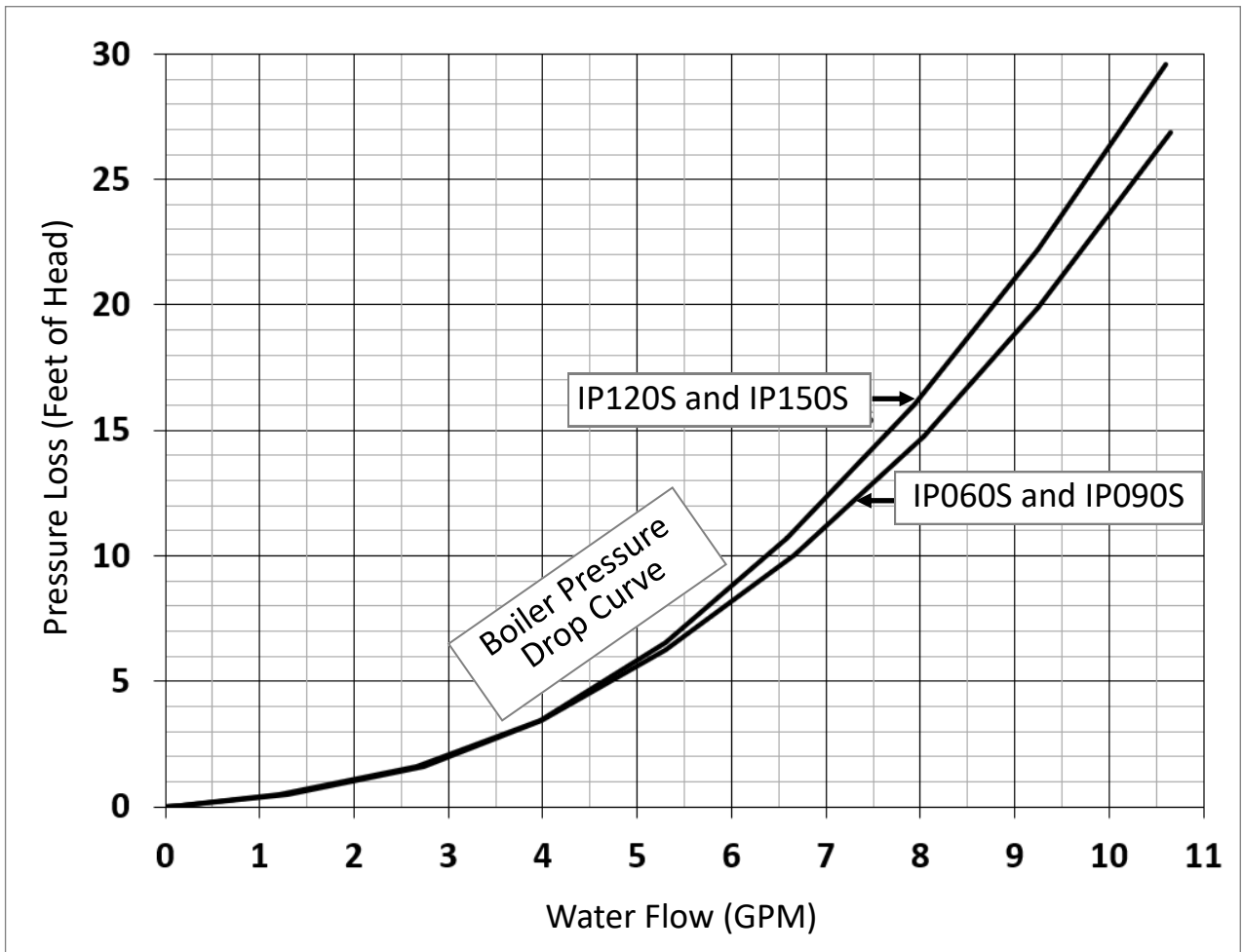

Figure 50

Below are options for the primary pump circulating across the boiler. No additional pressure drop is accounted for through the system piping or system components. Recommended circulation pumps are listed below. The maximum amperage permitted is 2 Amps.

Table 31

Model	Pump Model			
	Grundfos	Taco	Bell & Gossett	Armstrong
IP060S	UPS 15-42	007-IFC	NRF-25	ASTRO 230CI
IP090S	UPS 15-42	007-IFC	NRF-25	ASTRO 230CI
IP120S	UPS 15-58	008-IFC	NRF-25	ASTRO 230CI
IP150S	UPS 26-99	0011-IFC	N/A	ASTRO 280CI

Manufacturer part numbers are correct at time of publication and are subject to change without notice. Contact manufacturer to confirm performance and part number prior to placing an order.

7.6 Connect the Pressure Relief Valves

WARNING

Water discharged from the pressure relief valve could cause severe burns instantly or death from scalds.

7.6.1 General Guidelines

An approved pressure relief valve is required by the *American National Standard (ANSI Z21.13) and ASME Boiler and Pressure Vessel Code, Section IV (Heating Boilers)* for all water heating systems and shall be accessible for servicing (an approved pressure relief valve is supplied with the boiler). When connecting a pressure relief valve, follow the guidelines below:

- The pressure relief valve must comply with the standard for *Relief Valves and Automatic Gas Shutoff Devices for Hot Water Supply Systems ANSI Z21.22*, the *standard Temperature, Pressure, Temperature and Pressure Relief Valves and Vacuum Relief Valves, CAN1-4.4*, and/or the *ANSI/ASME Boiler and Pressure Vessel Code, Section IV (Heating Boilers)*.
- The pressure relief valve must be rated up to 30 psi for central heating systems, and to at least the maximum Btu/hr of the appliance.
- The discharge from the pressure relief valve should be piped to the ground or into a drain system per local codes.
- The pressure relief valve must be manually operated once a year to check for correct operation.
- The discharge line from the pressure relief valve should pitch downward and terminate 6 in. (152 mm) above drains where discharge will be clearly visible.

- The discharge end of the line shall be plain (unthreaded) and a minimum of 3/4 in. nominal pipe diameter. The discharge line material must be suitable for water at least 180°Fahrenheit (82°Celsius).
- If a pressure relief valve discharges periodically, this may be due to thermal expansion in a closed water supply system. Contact the water supplier or local plumbing inspector on how to correct this situation. Do not plug the pressure relief valve.
- The *American National Standard (ANSI Z21.13)* does not require a combination temperature and pressure relief valve for this appliance. However, local codes may require a combination temperature and pressure relief valve.
- Protect pressure relief valve and pressure relief valve discharge line from freezing. Do not plug or restrict flow of the pressure relief valve.

IMPORTANT

An ASME 30 psi safety pressure relief valve is included with the boiler and must be fitted before any shut off valve in the system.

- DO NOT plumb the pressure relief valve with the condensate drain; both must be plumbed independently to drain.
- DO NOT plug the pressure relief valve and do not install any reducing fittings or other restrictions in the relief line. The pressure relief line should allow for complete drainage of the valve and the line.
- DO NOT place any other valve or shutoff device between the pressure relief valve and the boiler.

7.7 Connect the Condensate Drain Line

7.7.1 Guidelines

To prevent condensate damage, follow these guidelines:

- Do not plumb the condensate drain with the pressure relief valve; both must be plumbed independently to drain.
- All condensate must drain and be disposed of according to local codes.
- Use only corrosion resistant materials for the condensate drain lines such as PVC pipe or plastic hose.
- The condensate drain pipe (along its entire length) must be at least the same diameter as the drain line (1/2 in. MNPT).
- Condensation drain lines installed in areas that are subject to freezing temperatures should be wrapped with an approved supplemental heat source. Install per manufacturer's instructions.
- Slope the condensate drain lines toward the inside floor drain or condensate pump.
- The end of the condensate drain pipe should be open to the atmosphere. The end should not be under water or other substances.

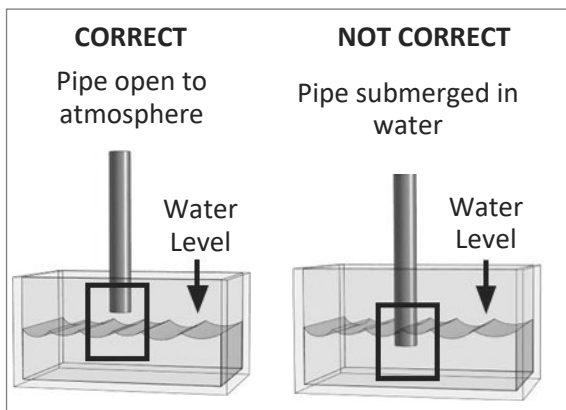

Figure 51

- For external (outdoor) installations, to minimize freezing of the condensate, run the condensate drain line through an interior wall or between insulation and an interior wall.
- If a floor drain is not available or the drain is above the level of the condensate drain, a condensate pump should be installed.

- A condensate neutralizer kit (part number 804000074) is available from Rinnai. The kit allows condensate to flow through neutralizing media that raises the pH of the condensate to a level that will help prevent corrosion of the drain and public sewer system. Refer to section "3.6 Accessories" for more information.
- The condensate drain pipe should be as short as possible and have a downward pitch.
- Pour approximately 10 ounces (1.25 cups) of water directly into the boiler's exhaust port.
- DO NOT connect the condensate drain line with an air conditioning evaporator coil drain.
- Boilers have an integrated condensate trap. DO NOT install an external condensate trap.



Figure 52

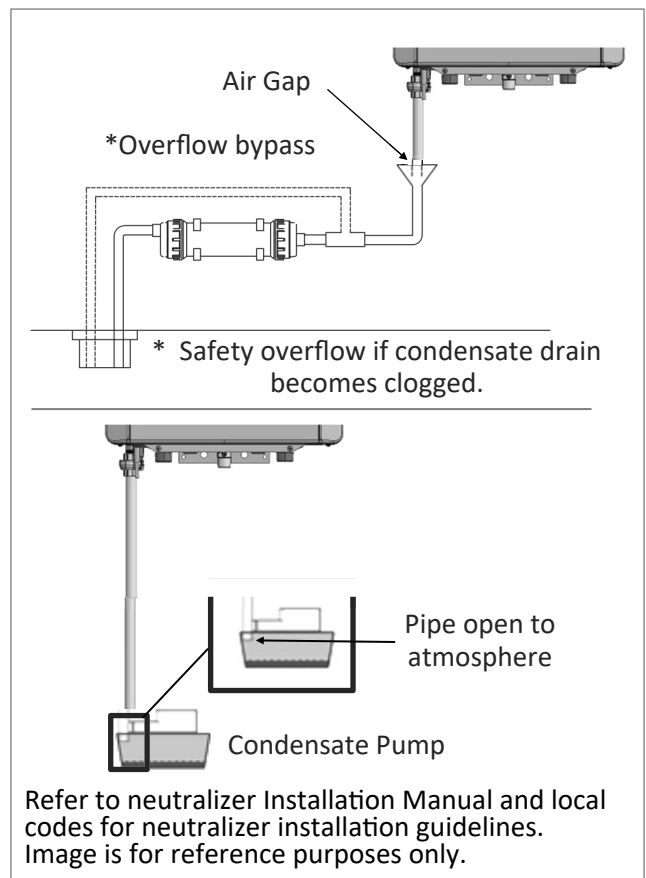

Figure 53

Refer to neutralizer Installation Manual and local codes for neutralizer installation guidelines. Image is for reference purposes only.

7.7.2 Connect the Condensate Drain Pipe

To connect the condensate drain pipe:

1. Apply thread sealant to 1/2 in. NPT condensate drain port.
2. By hand, thread 1/2 in. NPT fitting onto condensate drain port.
3. Follow the steps in the next section: "7.8 Condensate Pump Safety Switch Wiring."

IMPORTANT
DO NOT use a wrench to tighten the condensate drain pipe connection as this could cause the connection to break.

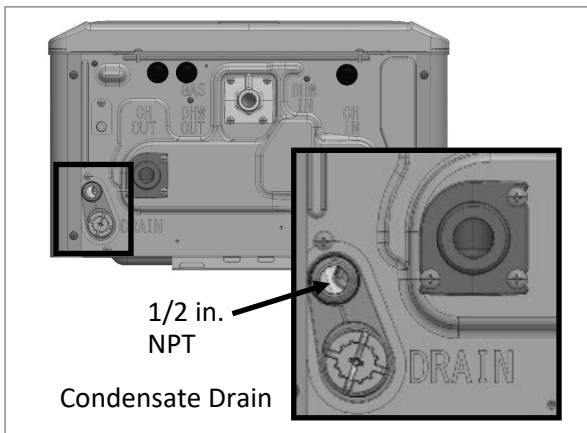

Figure 54

7.8 Condensate Pump Safety Switch Wiring

IMPORTANT
The steps in this section must conform with local codes and the guidelines established by the National Electrical Code (NEC).

The condensate pump (if installed) should be wired to deactivate the boiler in the event the condensate pump fails.

1. Disconnect power from the boiler.
2. Open the boiler cover and locate two white wires labeled "To Condensate Pump" (the wires may be located behind the PC Board).
3. Cut crimp connectors off white wires and strip the insulation off of the two ends.

4. Select an appropriate length of wire (18 AWG or greater) and strip the insulation off the ends. Follow the wiring guidelines established by the National Electrical Code (NEC).
5. With wire nuts or other approved wire connectors, connect the "To Condensate Pump" wires to the normally open contacts on the condensate pump (see image below).
6. Reconnect power to the boiler and press the "On/Off" button on the controller.

Test Operation

1. Test the operation of the shut off switch by unplugging the condensate pump and filling the condensate reservoir with water until the float switch closes the circuit.
2. Turn on the boiler.
3. The boiler displays diagnostic code "250."
4. Plug in the condensate pump and confirm condensate is flowing out of the reservoir.
5. Turn off the boiler by pressing the "On/Off" button on the controller. Wait five seconds, then turn the power back on. This will clear the diagnostic code.

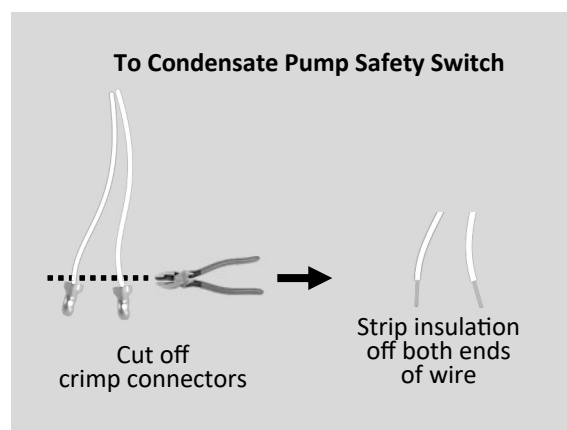

Figure 55

See visual illustration on next page.

IMPORTANT
Boiler condensate pump safety switch is NO (normally open) and faults when the circuit closes.

Condensate Pump Safety Switch Installation

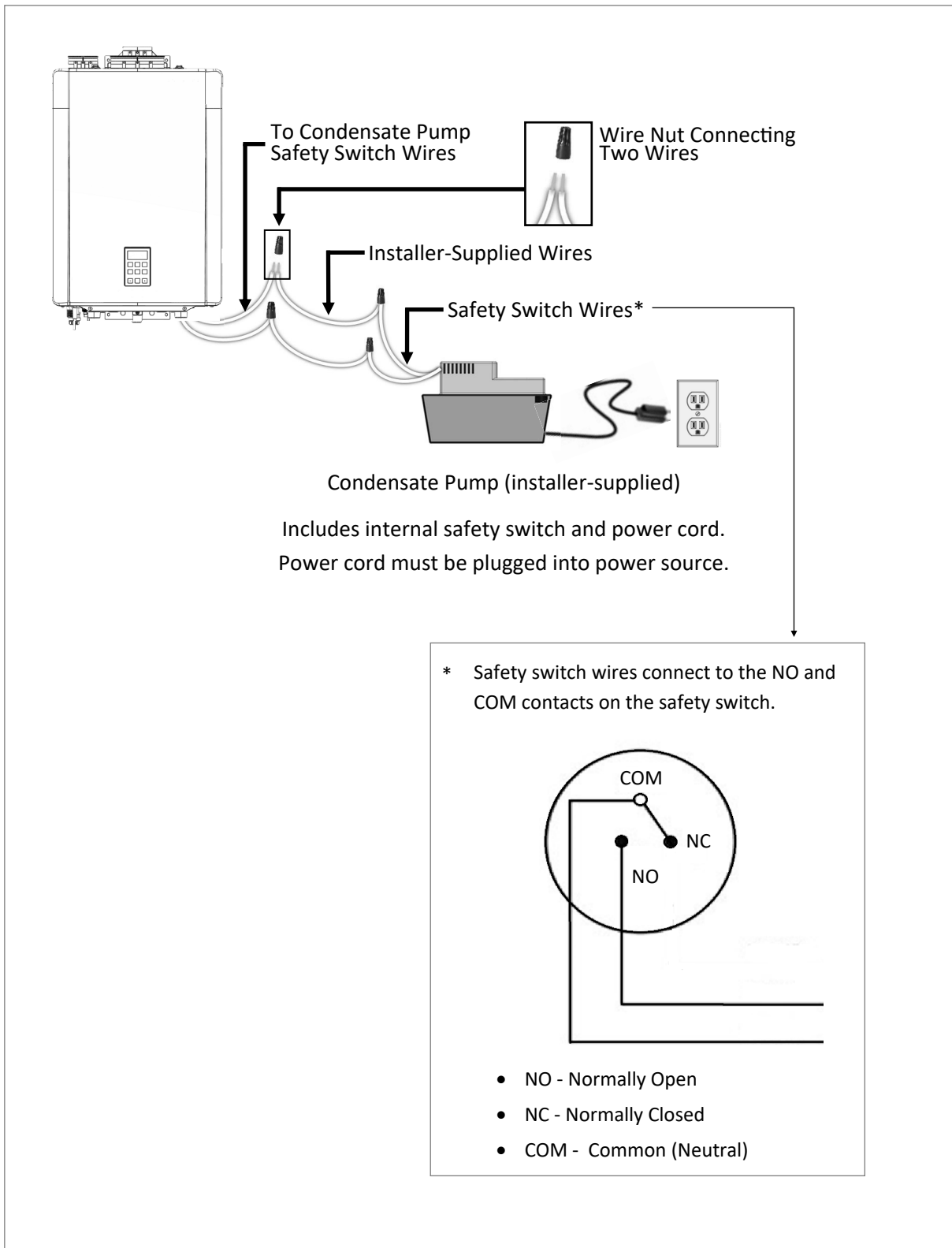

Figure 56

8. DHW System Piping with Indirect Tank

Topics in this section

- Guidelines
- Indirect Tank Control Options
- Indirect Tank Electrical Connections
- Simultaneous CH and DHW Operation
- Indirect Tank Parameter Settings
- Piping Diagram for a Basic DHW Installation

This boiler provides DHW through an indirect tank. The boiler incorporates temperature control features for the boiler and indirect tank controls, including indirect tank heating priority.

8.1 Guidelines

- The piping (including soldering materials) and components connected to this appliance must be approved for use in potable water systems.
- Purge the water line to remove all debris and air. Debris will damage the boiler.
- DHW must not be connected to a system that was previously used with a non-potable water heating appliance.
- DO NOT introduce toxic chemicals such as those used for boiler water treatment to the potable water used for central heating into the DHW system.

⚠ DANGER



Water temperatures over 125° F (52° C) can cause severe burns or scalding resulting in death.

Hot water can cause first degree burns with exposure for as little as:

- 3 seconds at 140°F (60°C)
- 20 seconds at 130°F (54°C)
- 8 minutes at 120°F (49°C)

Children, disabled, or elderly are at highest risk of being scalded. Feel water before bathing or showering.

8.2 Indirect Tank Control Options

The indirect tank temperature is controlled through either a thermistor (default) or thermostat.

- **Thermistor (Default):** In thermistor control of the tank, 180°F (82°C) is the maximum supply temperature. The higher the supply temperature to the tank, the quicker the tank will heat up. If 180°F (82°C) is too high, select other temperature settings as appropriate. When thermistor control is selected, Parameter 31 becomes available; this parameter selects the differential temperature between the indirect tank setpoint temperature and the recognized temperature of the thermistor. The smaller the value, the more frequently the indirect tank will call for heat.
- **Thermostat:** If thermostat control of the tank is desired, the thermostat connects to the T/T2 connection on the boiler PC board. In thermostat control of the tank, 180°F (default) (82°C) is the maximum supply temperature. The higher the supply temperature to the tank, the quicker the tank will heat up. If 180°F (82°C) is too high, select other temperature settings as appropriate. Ensure the indirect tank supply temperature is 18°F (10°C) higher than the set point temperature of the tank thermostat.

8.3 Indirect Tank Electrical Connections

When parameter 28 is set to “A”, the default position, Parameter 32 becomes available. The option to select an indirect tank pump (default) or a 3-Way Valve with the boiler pump for recovering the indirect tank becomes available. If the 3-Way Valve option is desired, only 120VAC 3-Way Valves may be used. Do not use a 3-Way Valve if simultaneous CH and DHW via an indirect tank is desired.

1. Remove the boiler’s front panel by removing the two screws that secure the panel.
2. Locate the PC Board (lower left side of unit).
3. Connect the indirect tank thermistor to the terminals shown below using minimum 18 AWG wiring to the two terminals provided in the enclosure.
4. Ensure Parameter 29 is set to “A” for thermostat control or “b” for thermistor control of the indirect tank.
5. Set parameters 30-35 as appropriate for your application (see the Parameter Settings Table for more information).

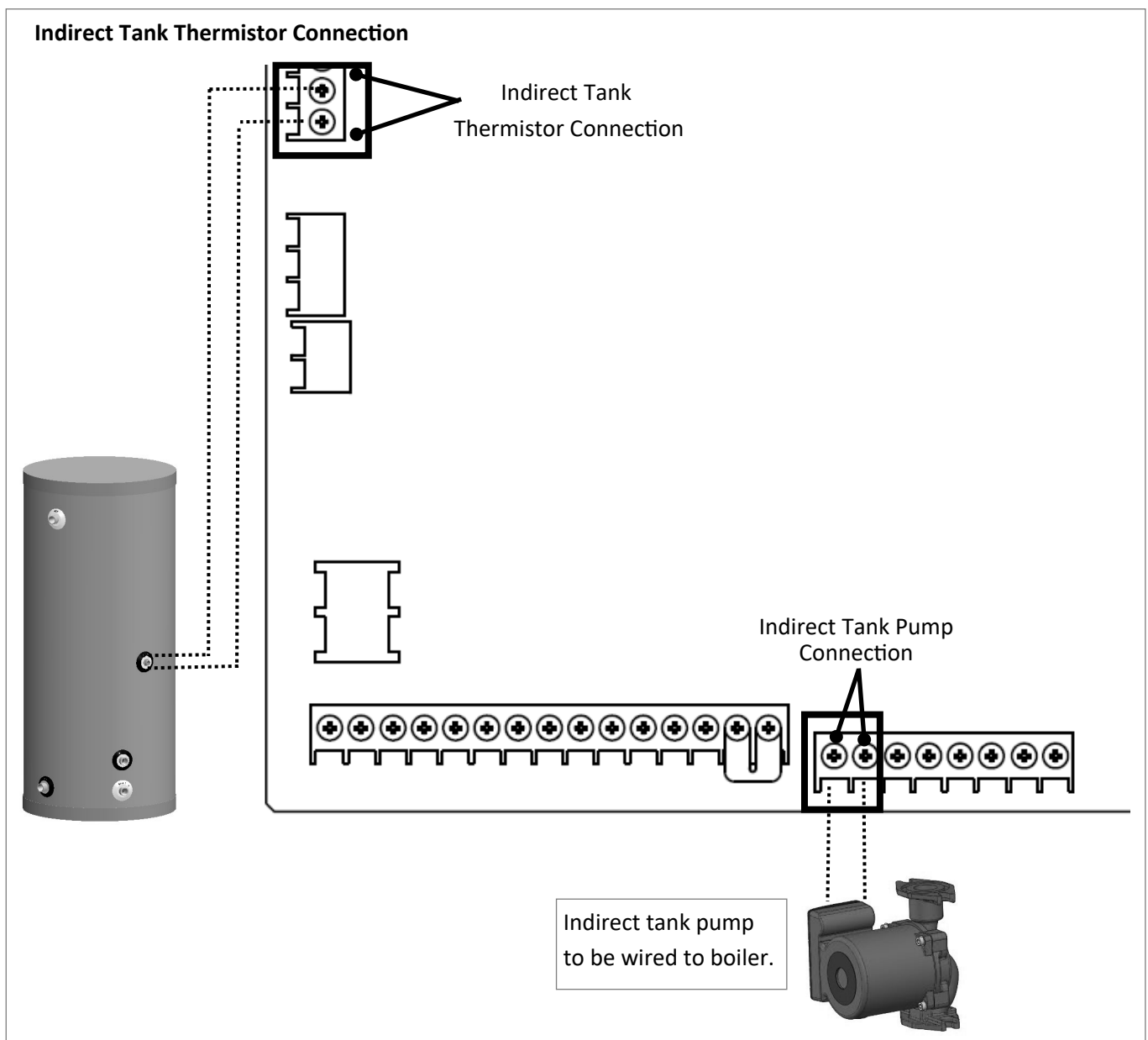

Figure 57

Indirect Tank Thermostat Connection

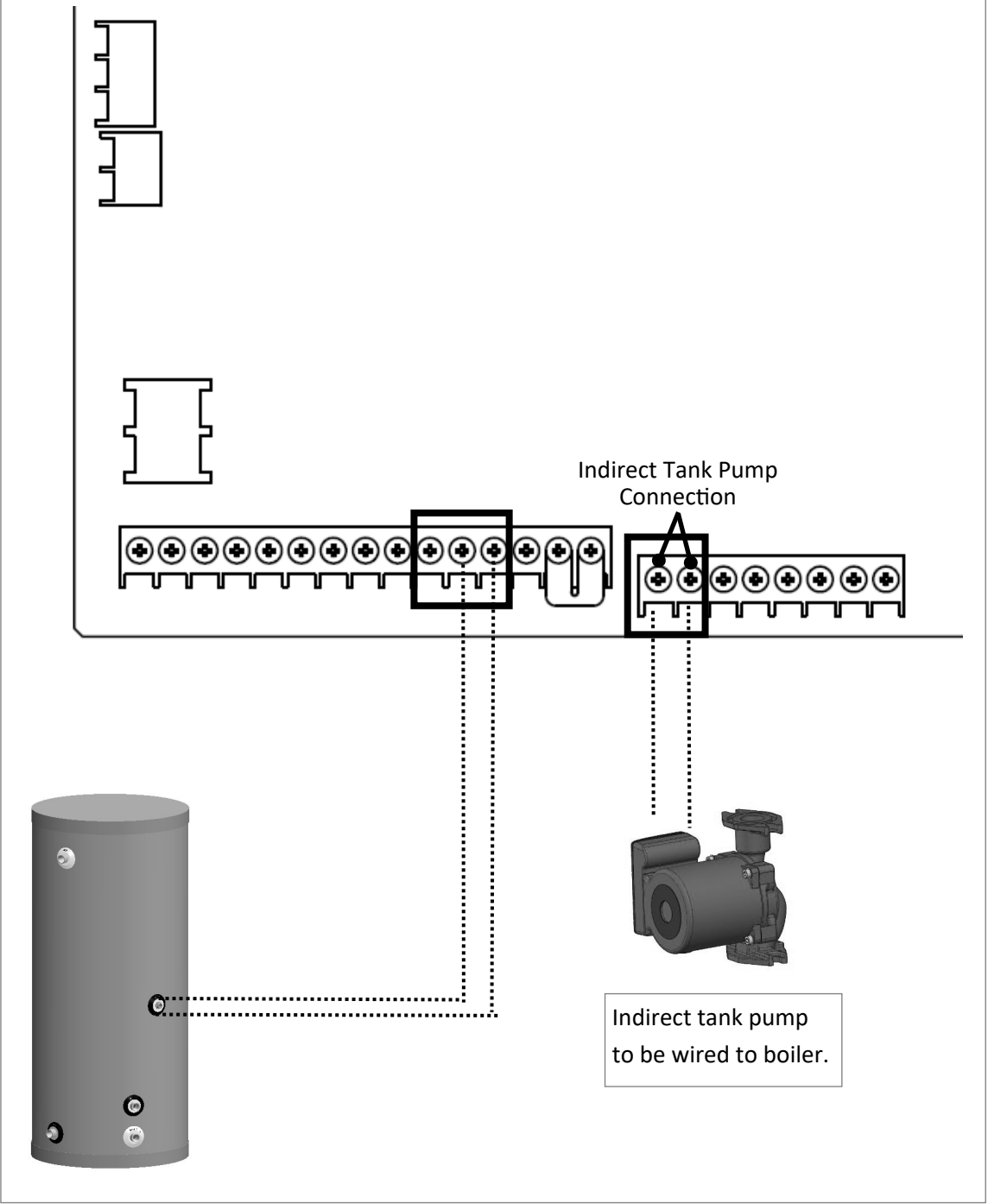

Figure 58

8.4 Simultaneous CH and DHW Operation

The boiler has the ability to operate simultaneously between central heating and domestic indirect tank heating. The boiler can control dividing the flow between domestic hot water production to the indirect tank and the central heating circuit.

The boiler is set to domestic indirect tank recovery as the priority. If it is desired to have simultaneous operation of central heating and domestic hot water, access the parameters (as shown in the "Parameter Settings" section of this manual) and adjust parameter 33 to "b."

When Parameter 28 is set to "A", the option to select the duration of the indirect tank priority will become available in Parameter 34. After this period of time passes, the indirect tank will cease to be heated and central heating will have priority. If there is still an indirect tank demand after 60 minutes passes of CH priority, indirect tank priority will begin again.

When Parameter 28 is set to "A", Parameter 32 is selected to be "Use Pump," and when Parameter 33 is selected to be "Simultaneous Heating with Indirect Tank and CH" Parameter 35 becomes available. This enables CH setting limitation during simultaneous heating. This can prevent unintentionally supplying high temperature supply water to low water heating temperature applications such as floor heating. During simultaneous operation, the heating supply temperature is based on the indirect tank supply temperature. When "NO" is selected, make sure that the CH system and heating application is designed to allow for the high supply temperature.

IMPORTANT:

The central heating supply temperature may be up to 180°F (82°C) or higher during simultaneous operation. If the central heating temperature is lower than 140°F (60°C), the default setting is not to permit the simultaneous operation. The boiler would then default to a DHW system with Indirect Tank priority setting. In this scenario, it prevents unintentionally supplying high temperature supply water to low water heating application.

If the indirect tank setting is above 140°F (60°C) and it is desired to have simultaneous operation with the indirect tank setpoint higher than the CH setpoint, access the parameters (as shown in the "Parameter Settings" section of this manual) and adjust parameter 35 to "b." In this scenario, there is the potential to have higher temperature water being supplied to the central heating system. Ensure that the central heating system is designed for this high supply water temperature.

NOTE

- When set for simultaneous operation, the time to recover the indirect tank may be increased. If high domestic hot water usage is desired without greater potential of temperature loss, it is not recommended to use the simultaneous operation feature.
- When the boiler is unable to perform simultaneous operation between CH and recovering an indirect tank, the indirect tank heating will take priority and CH operation will occur after the tank temperature is satisfied or indirect tank priority time has elapsed.

8.5 Indirect Tank Parameter Settings

NOTE

Refer to section “12.4.1 Parameter Settings Table” for more information on parameter settings.

Table 32

Parameter Number	Setting Description	Selection				
		A	b	C	d	
30	Indirect Tank Supply Temperature with Thermistor Control	180°F (82°C)	Setting Temperature +18°F (+10°C)	Setting Temperature +27°F (+15°C)		
	Indirect Tank Supply Temperature with Thermostat Control	180°F (82°C)	160°F (71°C)	140°F (60°C)		
31	Allowed Indirect Tank Temperature Drop before Firing (with Thermistor)	5.4°F (3°C)	10.8°F (6°C)	16.2°F (9°C)	21.6°F (12°C)	
32	Indirect Tank Operation Option	Use Pump	Use 3-Way Valve			
33	Indirect Tank Simultaneous Heating	Indirect Tank Priority	Simultaneous Heating with Indirect Tank and CH			
34	Indirect Tank Priority Time	60 minutes	40 minutes			90 minutes
35	CH Temperature Limitation to Allow Simultaneous Operation with Indirect Tank	Yes	No			

8.6 Piping Diagram for a Basic DHW Installation

This is not an engineering drawing; it is intended only as a guide and not as a replacement for professional engineering project drawings. This drawing is not intended to describe a complete system. It is up to the contractor or engineer to determine the necessary components and configuration of the particular system to be installed. The drawing does not imply compliance with local building code requirements. It is the responsibility of the contractor or engineer to ensure the installation is in accordance with all local building codes. Confer with local building officials before installation.

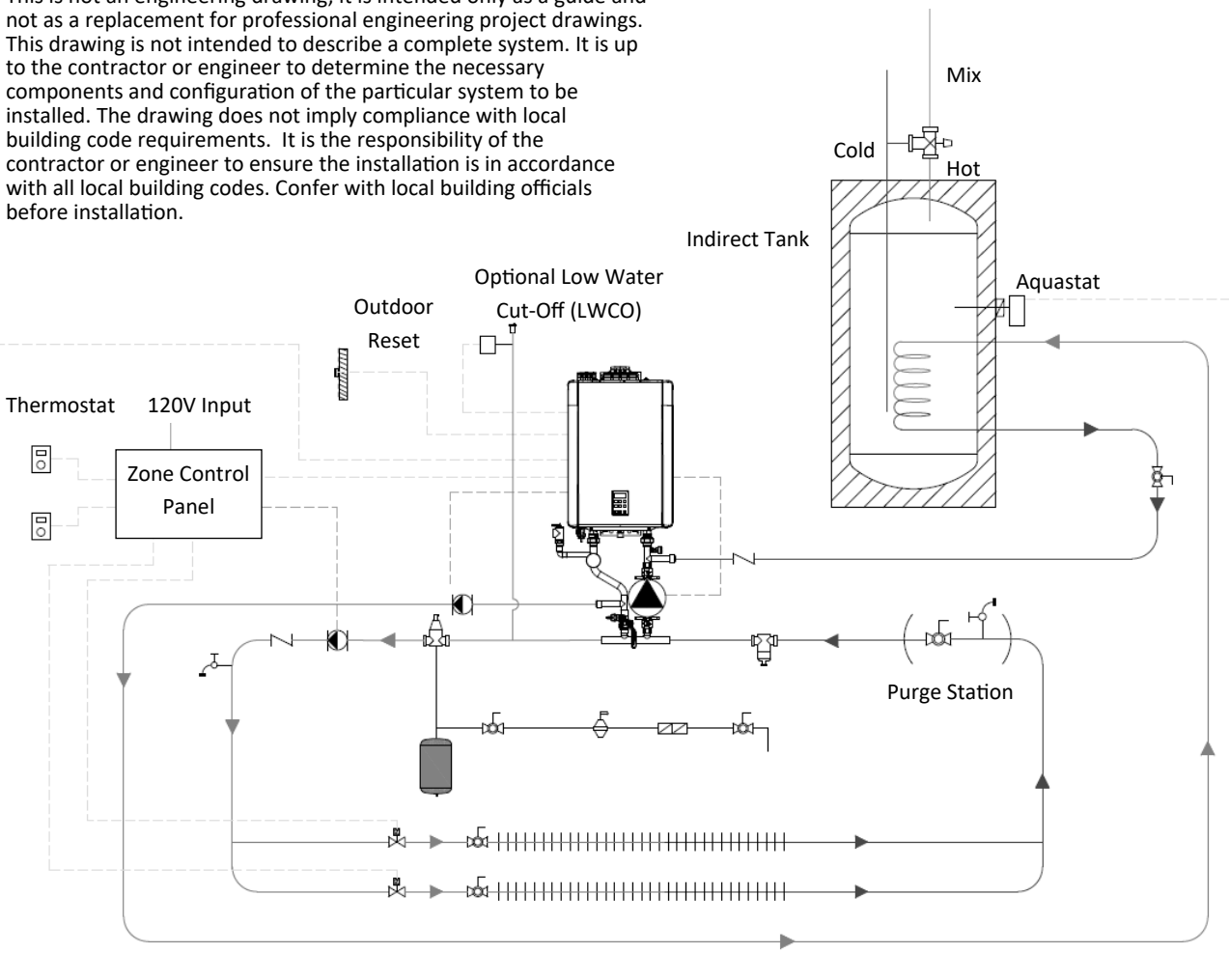

LEGEND

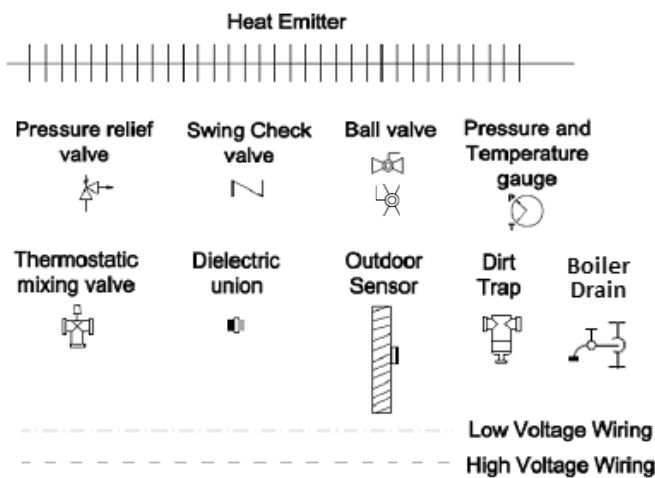

The image below illustrates a suggested arrangement. Some of the fittings are optional.

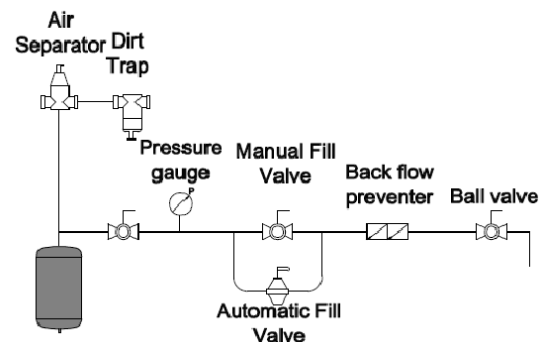

Figure 59

9. Power Supply

Topics in this section

- Guidelines
- Electrical Connections
- Post-Power Supply Connection Checklist
- Initial Settings

WARNING

- Do not use an extension cord or adapter plug with this appliance.
- The boiler must be electrically grounded in accordance with local codes and ordinances or, in the absence of local codes, in accordance with the National Electrical Code, ANSI/ NFPA No. 70.
- Boilers are equipped with a three-prong (grounding) plug for your protection against shock hazard and should be plugged directly into a properly grounded three-prong receptacle. Do not cut or remove the grounding terminal from this plug.

CAUTION

- This boiler is supplied with 120 volts and is equipped with a three-prong (grounding) plug for your protection against shock hazard. The plug should be plugged directly into a properly grounded three-prong receptacle. Do not cut or remove the grounding terminal from this plug.
- Disconnect incoming power to the boiler by removing the three-prong plug before:
 - Performing repairs or installation to internal components or accessories.
 - Making wiring connections and/or changes to the wiring terminals on the boiler.

CAUTION

- No changes may be made to the wiring of the boiler.
- All connections should be designed in accordance with the applicable regulations.
- Label all wires prior to disconnection when servicing controls. Wiring errors can cause improper and dangerous operation.
- Verify proper operation after operation servicing.

9.1 Guidelines

When connecting the power supply, follow these guidelines:

- If using the 5 ft (1.5 m) power cord (supplied with boiler), plug it into a standard three-prong 120 VAC, 60 Hz properly grounded wall outlet.
- The boiler requires 120 VAC, 60 Hz power from a properly grounded circuit.
- Do not rely on the gas or water piping to ground the boiler. Ground locations are provided inside the boiler.
- The wiring diagram is located on the inside of the boiler front cover.

IMPORTANT

A manually operated remote switch should be located outside the boiler room door for shutting down the boiler. Consideration should be given to protect the switch against tampering. If there is more than one door to the boiler room, a switch should be located at each door.

9.2 Electrical Connections

Devices such as the room thermostat, outdoor temperature sensor, zones pumps, and relay controls are connected to the boiler PC Board.

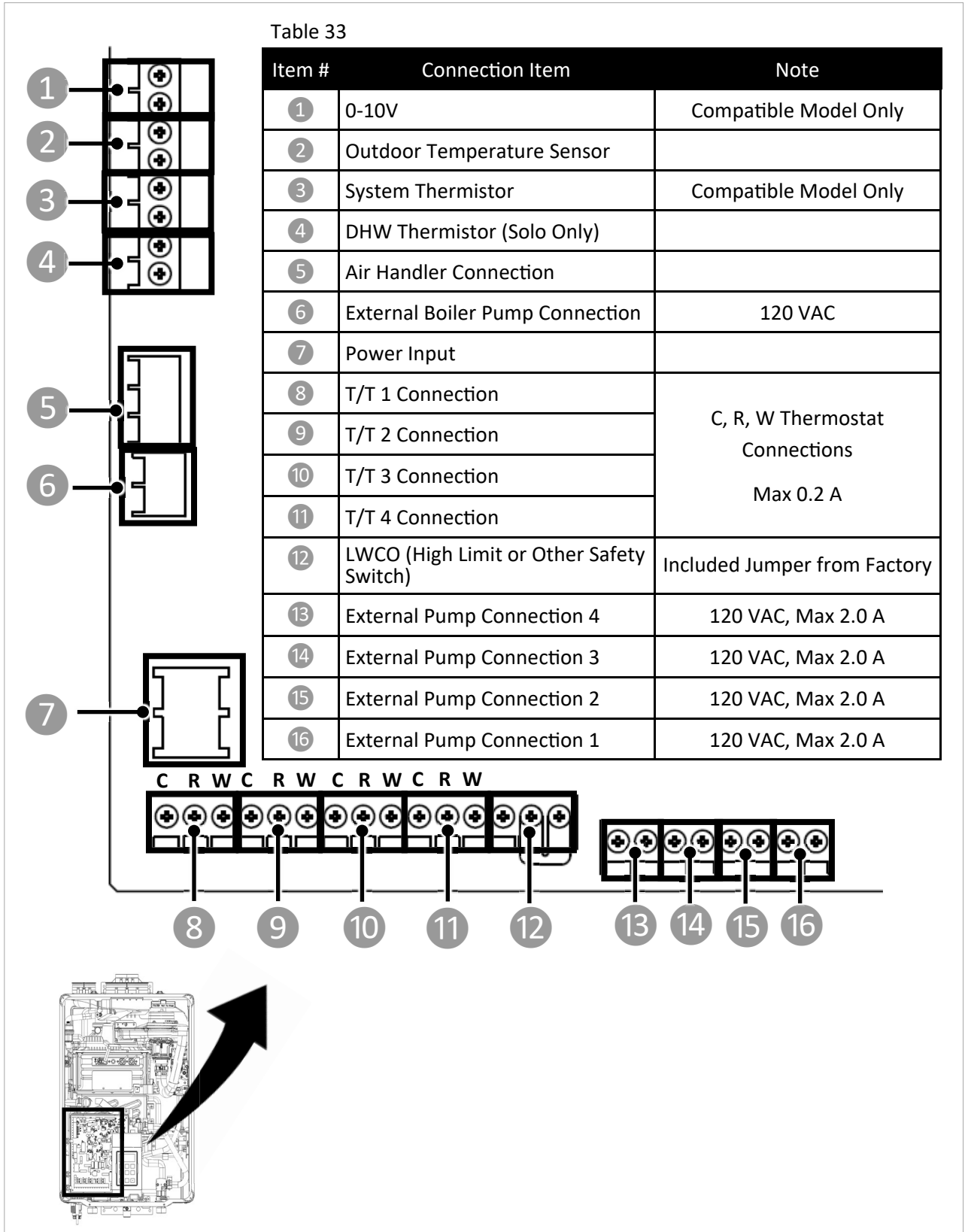

Figure 60



CAUTION

- Rinnai recommends the use of spade connectors or similar components for wiring to the screw terminals.
- Ensure that the insulation of the wire is not exposed to contact any other components besides the terminal.
- If exposed wiring contacts to any other exposed wiring or metal components, an electrical short may occur and cause damage to the PCB or other connected components.
- Use proper size of screwdriver for preventing the screw on the terminal from breaking.
- Do not use an electric or torque screwdriver for wiring on the PC Board.
- Wiring should pass through the grommets provided at the bottom of the boiler.
- Use proper diameter and size of wiring.

9.3 Post-Power Supply Connection Checklist

<input type="checkbox"/>	Confirm that the electricity is supplied from a 120 VAC, 60 Hz power source and is in a properly grounded circuit.
<input type="checkbox"/>	Confirm that an extension cord or adapter plug has NOT been used with the boiler.
<input type="checkbox"/>	Confirm connection terminals are connected correctly.

9.4 Initial Settings

This boiler is set up for natural gas and PVC indoor installations as default. When power is connected for the first time, you need to confirm the settings below or change them properly.



WARNING

If proper settings are not selected before you use the boiler, it will cause a hazardous situation which results in personal injury or property damage.

Confirm/change initial settings of the boiler by choosing one of the two options below:

Option 1 (recommended): Confirm/change settings from a smart device using Bluetooth Low Energy (BLE).

Option 2: Confirm/change settings from the boiler controller.

Option 1: BLE

To confirm/change initial settings of the boiler from a smart device using BLE (recommended), follow the steps below:

Note: To utilize BLE, your connecting device (smartphone, tablet, computer, etc.) needs to have Bluetooth 4.0 or a newer version. Contact your connecting device manufacturer if you are not sure. If your connecting device has Bluetooth 4.0 or a newer version.

1. Download the Rinnai Central app by scanning the following QR code:



2. Supply power to the boiler for the first time. The controller displays “SEt” and the **Maintenance Mode** icon on the controller is blinking.



Figure 61

3. Open the Rinnai Central app from your smart device and log into the Rinnai Central app with a professional account.
4. Push the Bluetooth button on the controller. The Bluetooth LED light turns solid.

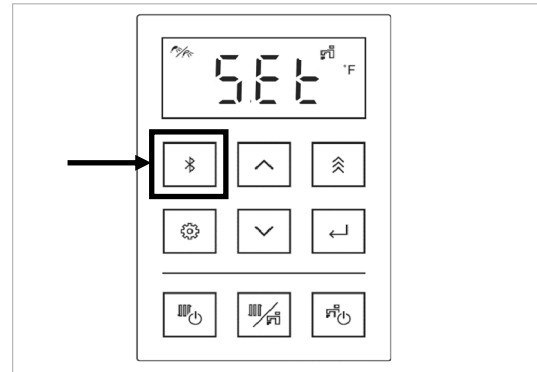

Figure 62

5. Tap “Connect to a Rinnai Boiler” on the Rinnai Central app. You will hear a beeping sound when pairing between the app and boiler is established.

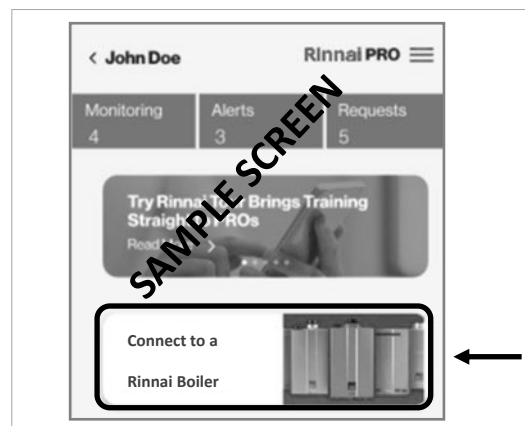

Figure 63

6. Follow the steps in the Rinnai Central app to confirm and/or change your boiler settings.
7. When settings are completed, the controller display will be normal operation status.



Figure 64

Option 2: Controller

1. Supply power to the boiler for the first time. The controller displays "SEt" and the **Maintenance Mode** icon appears.

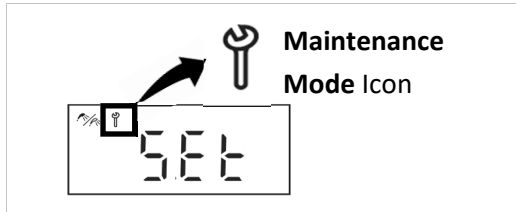

Figure 65

2. Press the Select button. The controller displays "nG" (natural gas).

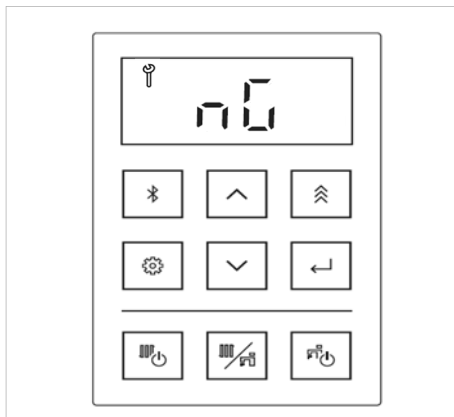

Figure 66

- 3(A). **If using natural gas:** Press the Select button to confirm natural gas. Then, proceed to step 4.

If using propane gas, skip this step and proceed to step 3(B).

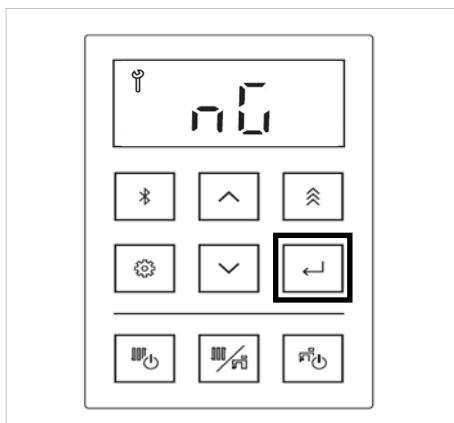

Figure 67

- 3(B). **If using propane gas:** Press the up or down arrow button. The controller displays "LPG" (Liquid Propane Gas).

Press the Select button to confirm Liquid Propane Gas. Proceed to step 4.

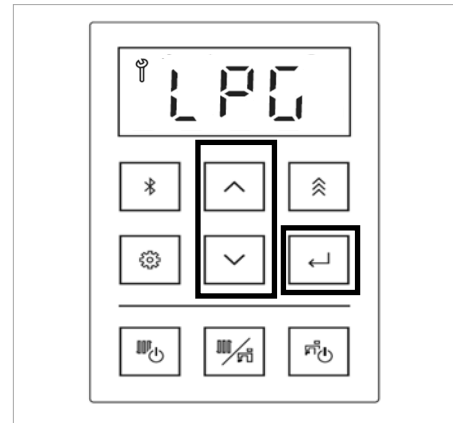

Figure 68

4. The controller displays "PVC."

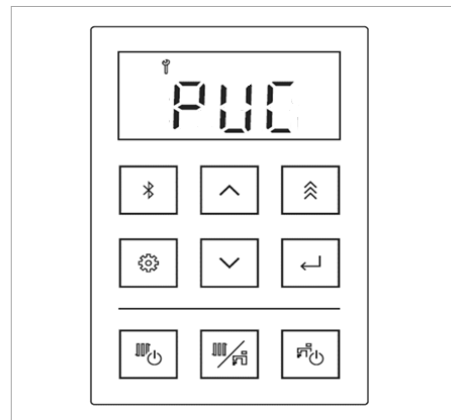

Figure 69

- 5(A). **If you install the boiler by PVC venting:**

Press the Select button. Proceed to step 6.

If you install the boiler by PP venting:

Proceed to step 5(B).

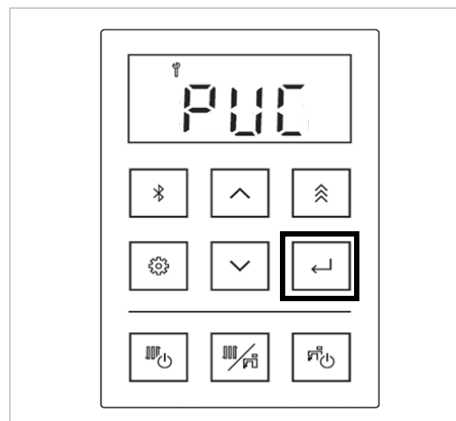

Figure 70

- 5(B). **If you install the boiler by PP venting:**
 Press the up or down arrow buttons.
 The controller displays “PP.” Press the select button to confirm PP. When you re-enter each setting, press the setting menu button to go back to step 1.
 Proceed to step 6.

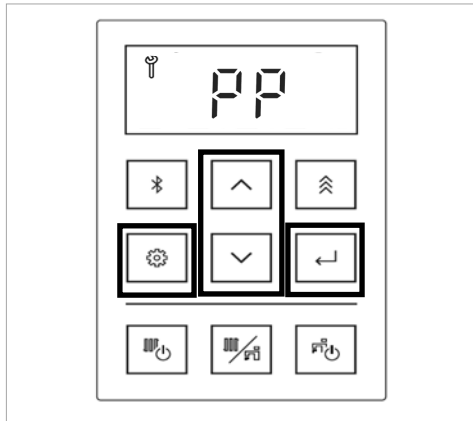

Figure 71

6. The controller displays “nG” or “LPG” and “PVC” or “PP” alternatively while the Setting menu button and ON/OFF button is blinking. The controller shows the current gas setting and venting setting.

For example, the controller displays “NG” and “PVC” alternatively, indicating the boiler is set for natural gas and PVC venting installation. If you need to change these settings, press the Setting menu button to go back to step 1. Otherwise, press the “ON/OFF” button.

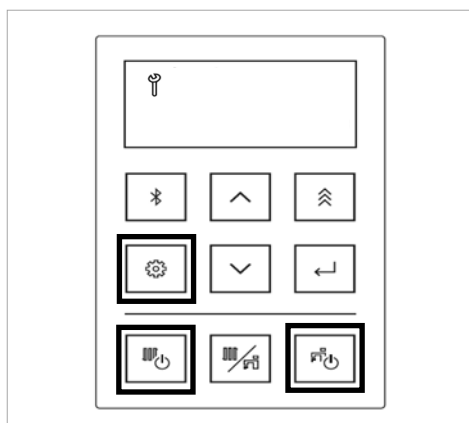

Figure 72

7. The controller briefly displays “888” while a beeping sound is observed. Then, complete initial settings and the controller is off.



Figure 73

8. If you set initial settings incorrectly, you can adjust the settings by configuring the parameter settings. Follow the steps in section “12.4 Parameter Settings” and change parameters R0 (Gas Type) and R2 Venting correctly.
9. After initial settings are completed, press the On/ Off button to turn on the unit.

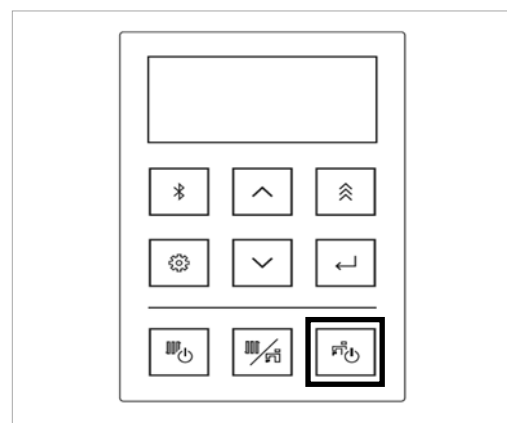

Figure 74

10. If “LPG” (Liquid Propane Gas) is selected, apply the supplied gas conversion label at an open space above the existing label on the left side of the boiler.
 Note: See the “Key Points For A Successful Installation” document (on boiler front cover) for illustration of label location.
11. The default altitude setting for this boiler is 0-2,000 ft. (0-610 m). If this boiler is installed at a different altitude, select the appropriate altitude setting. Also, set up other parameters property. Refer to section “12.4 Parameter Setting” for specific details on setting parameters.

10. Commissioning

Topics in this section

- Safety Precautions
- Filling Process
- Deaeration Process

THIS SECTION IS INTENDED FOR THE INSTALLER

This boiler must be commissioned by a licensed professional. Installer qualifications: A trained and qualified professional must install the appliance, inspect it, and leak test the boiler before use. The warranty will be voided due to any improper installation. The trained and qualified professional should have skills such as: Gas sizing; Connecting gas lines, water lines, valves, and electricity; Knowledge of applicable national, state, and local codes; Installing venting through a wall or roof; and training in installation of condensing boilers. Training for Rinnai Condensing I-Series Plus Boilers is accessible online at rinnaiapro.myabsorb.com.

Boiler commissioning is a procedure used after boiler installation to ensure the system and boiler were installed correctly and ready for operation.

10.1 Safety Precautions

WARNING

Failure to properly commission the boiler as described in this section may result in unreliable and unsafe burner operation and reduced component life.

IMPORTANT

- Work on the boiler must be carried out by a licensed professional, using correctly calibrated instruments with current test certification. The commissioning instructions are intended for licensed professionals who have the necessary knowledge and are approved for working on heating and gas systems.
- The fan will operate when power is initially provided to perform a safety check on the boiler.
- The boiler and its individual shut off valve must be disconnected from the gas supply piping system during any pressure testing of that system at test pressures in excess of 1/2 PSI (3.5 kPa).
- Before the boiler is fired for the first time:
 - Ensure the boiler and system are fully de-aerated
 - Purge the gas line between the gas meter and boiler
 - Prime the pump (as described in this section)

10.2 Filling Process

IMPORTANT

Do not fill the boiler unless permanent power is available. Freeze protection is not available if the boiler is not filled, air purged, and supplied with power and gas.

1. Ensure all boiler components are installed correctly.
2. Open the air vent inside the boiler.
3. Power on the boiler.
4. Open the fill valve on the filling circuit.
5. Check the pressure on the controller and/or pressure gauge. Fill the boiler to a minimum of 20 PSI (138 kPa) water pressure and a maximum of 30 PSI (207 kPa).
6. An E430 diagnostic code will be present until the boiler senses at least 13 PSI (90 kPa).
7. Check the heating system for leaks.
8. Begin the deaeration process shown in the next section (“10.3 Deaeration Process”).

10.3 Deaeration Process

You Will Need:

- Philips head screwdriver

1. Remove the boiler's front panel by removing the two screws that secure the panel.

Note: Alternately, on initial installation, you may press and hold the **DHW** button then simultaneously press the **CH** button on the control panel instead of removing the boiler's front panel.

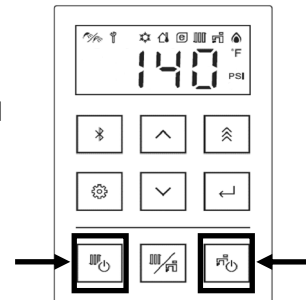

Figure 75

2. On the PC Board, press and hold the SW2 button shown below. The **Maintenance Mode** icon (see right image) on the controller display will appear and initiate the deaeration process.

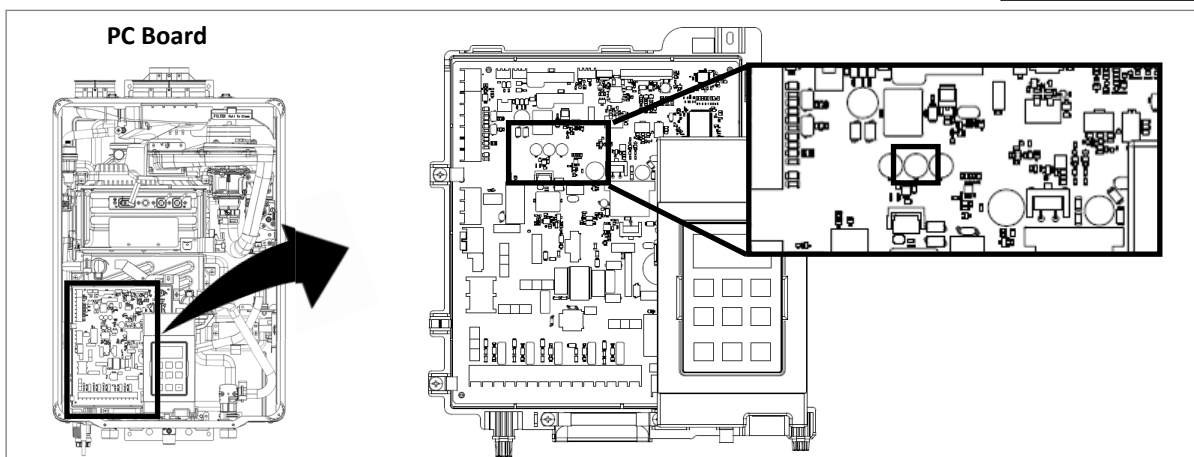
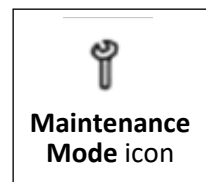

Figure 76

3. Confirm whether all heat emitters and pumps are connected to the piping system.
4. Fill the boiler to a minimum of 20 PSI (138 kPa) water pressure and a maximum of 30 PSI (207 kPa).
5. The deaeration process takes approximately 15 minutes for completion.

After 15 minutes, the display will show "End" (see right image). The commissioning process is complete.

6. On the PC Board, press and hold the SW2 button again to resume normal operation mode.
7. Operate the central heating to ensure the boiler operates properly.
8. Close the air vent located inside the boiler. After approximately one week, all air in the system should be eliminated via the air separator in the piping system.

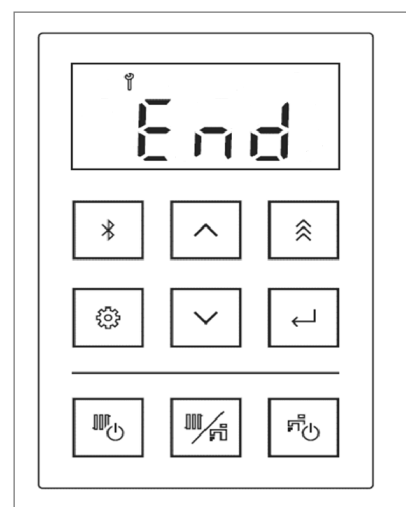

Figure 77

10.3.1 Bypass Deaeration

Deaeration is an effective method of purging air from the boiler after the system has been filled or serviced. While the boiler is running the deaeration process, the **Maintenance Mode** icon (see image) appears on the controller display.

Do not bypass deaeration during commissioning or if the system pressure has dropped below 13 PSI (90 kPa). If there is any chance that air has entered the system, deaeration is critical to prevent damage to the boiler.



Maintenance Mode icon

WARNING

DO NOT bypass the deaeration program during commissioning or if any part of the system has been opened or disconnected. Failure to properly deaerate the boiler and system may result in damage to the boiler, which is not covered by the boiler warranty.

To initiate or end the deaeration process, press and hold the SW2 button (shown below).

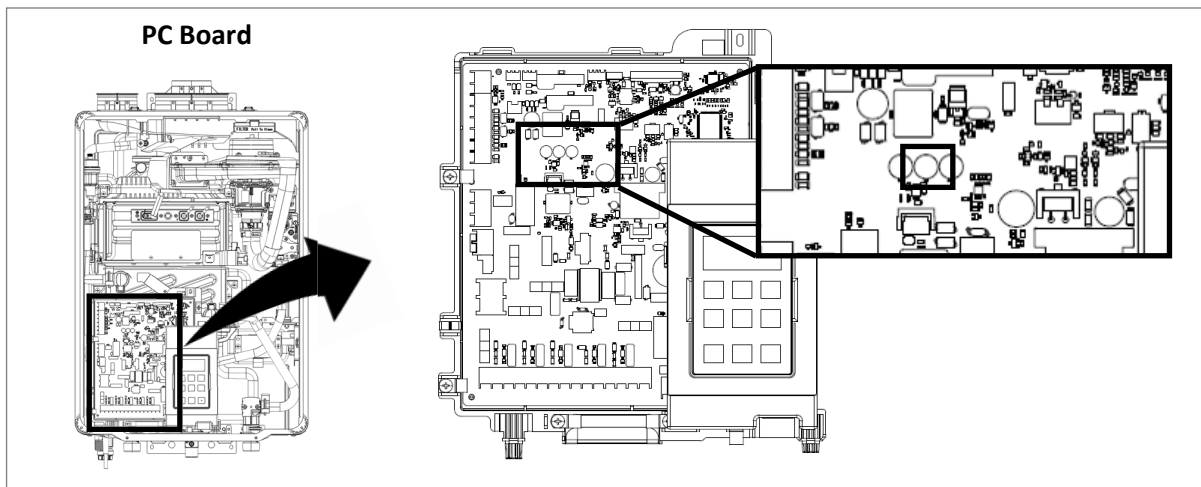

Figure 78

11. Post-Installation Checklist

Complete the following checklist when boiler installation is complete. You should be able to answer YES to each question. If you answer NO, installation is not complete. Refer to the applicable section in this manual for additional information.

INSTALLATION LOCATION	YES	NO
Have you verified the unit, vent and air intakes meet the clearance requirements?	<input type="checkbox"/>	<input type="checkbox"/>
VENTING	YES	NO
Have all corrosive compounds been removed from around the combustion air intake of the boiler?	<input type="checkbox"/>	<input type="checkbox"/>
Have you followed the combustion air requirements to provide sufficient combustion air for the boiler?	<input type="checkbox"/>	<input type="checkbox"/>
Are the correct venting products for the installed model being utilized?	<input type="checkbox"/>	<input type="checkbox"/>
Have you installed the vent screen(s) for Schedule 40 PVC/CPVC vent applications if applicable?	<input type="checkbox"/>	<input type="checkbox"/>
Have you verified the vent system does not exceed maximum length?	<input type="checkbox"/>	<input type="checkbox"/>
SYSTEM PIPING	YES	NO
Have the water lines been purged of all debris and the filter cleaned?	<input type="checkbox"/>	<input type="checkbox"/>
Have you verified the hot and cold water lines to the boiler are not interchanged?	<input type="checkbox"/>	<input type="checkbox"/>
Does the water supply to the boiler have adequate pressure? Is it free of chemicals? Did you verify it does not exceed total hardness that will damage the heat exchanger?	<input type="checkbox"/>	<input type="checkbox"/>
Have you verified that no toxic chemicals were introduced to the potable water?	<input type="checkbox"/>	<input type="checkbox"/>
Did you drain the boiler if not intended to be used immediately?	<input type="checkbox"/>	<input type="checkbox"/>
Have water quality issues (if any) been addressed?	<input type="checkbox"/>	<input type="checkbox"/>
Have you performed the leak and pressure test for the boiler and plumbing system?	<input type="checkbox"/>	<input type="checkbox"/>
CONDENSATE DRAIN	YES	NO
If the condensate pump is installed, is it wired to deactivate the boiler in the event of failure?	<input type="checkbox"/>	<input type="checkbox"/>
Did you verify the condensate drain pipe is as short as possible and has a downward pitch toward the drain or condensate pump?	<input type="checkbox"/>	<input type="checkbox"/>
Is all condensate drained and disposed of as per local codes?	<input type="checkbox"/>	<input type="checkbox"/>
Did you use ONLY corrosion resistant materials for the condensate drain lines?	<input type="checkbox"/>	<input type="checkbox"/>
Did you verify the condensate drain pipe along its entire length is at least the same diameter as the drain line?	<input type="checkbox"/>	<input type="checkbox"/>
Did you check to ensure the condensation drain lines are protected from freezing?	<input type="checkbox"/>	<input type="checkbox"/>
Have you verified the condensate drain line is not plumbed with the pressure relief valve?	<input type="checkbox"/>	<input type="checkbox"/>
Have you confirmed the condensate drain line is not connected with an air conditioning evaporator coil drain?	<input type="checkbox"/>	<input type="checkbox"/>
This boiler has an integrated condensate trap. Have you verified that an external condensate trap is not installed?	<input type="checkbox"/>	<input type="checkbox"/>
Have you confirmed the end of the condensate drain pipe is open to atmosphere?	<input type="checkbox"/>	<input type="checkbox"/>
Has an air gap been installed in the condensate drain line?	<input type="checkbox"/>	<input type="checkbox"/>

PRESSURE RELIEF VALVE (PRV)	YES	NO
Does the PRV comply with the standard for <i>Relief Valves and Automatic Gas Shutoff Devices for Hot Water Supply Systems ANSI Z21.22</i> , and/or the standard <i>Temperature, Pressure, Temperature and Pressure Relief Valves and Vacuum Relief Valves, CAN1-4.4</i> ?	<input type="checkbox"/>	<input type="checkbox"/>
Is the discharge from the PRV piped to the ground or into a drain system as per local codes?	<input type="checkbox"/>	<input type="checkbox"/>
Is the discharge line from the PRV pitched downward and does it terminate 6 in. (152 mm) above the drains?	<input type="checkbox"/>	<input type="checkbox"/>
Is the discharge end of the line plain (unthreaded) and a minimum of 3/4 in. diameter?	<input type="checkbox"/>	<input type="checkbox"/>
Is the discharge line material suitable for at least 180°F/(82°C) water?	<input type="checkbox"/>	<input type="checkbox"/>
Did you take measures to protect the PRV and PRV discharge line from freezing?	<input type="checkbox"/>	<input type="checkbox"/>
Have you verified the PRV is not plumbed with the condensate drain line?	<input type="checkbox"/>	<input type="checkbox"/>
Have you verified the PRV is not plugged and that reducing fittings, valves, or other restrictions are not installed in the relief line?	<input type="checkbox"/>	<input type="checkbox"/>
GAS SUPPLY	YES	NO
Did you verify the gas system is appropriately sized?	<input type="checkbox"/>	<input type="checkbox"/>
Did you verify the boiler is rated for the gas type supplied?	<input type="checkbox"/>	<input type="checkbox"/>
Have you performed a gas line and connection leak test?	<input type="checkbox"/>	<input type="checkbox"/>
Did you install a manual gas control valve in the gas line to the boiler?	<input type="checkbox"/>	<input type="checkbox"/>
Is the inlet gas pressure within limits?	<input type="checkbox"/>	<input type="checkbox"/>
Did you purge the gas line of any debris before connecting the boiler?	<input type="checkbox"/>	<input type="checkbox"/>
POWER SUPPLY	YES	NO
Did you confirm that the electricity is supplied from 120 VAC, 60 Hz power source and is in a properly grounded circuit?	<input type="checkbox"/>	<input type="checkbox"/>
Did you confirm that an extension cord or an adapter plug has NOT been used with the boiler?	<input type="checkbox"/>	<input type="checkbox"/>
COMMISSIONING	YES	NO
Did you prime the pump?	<input type="checkbox"/>	<input type="checkbox"/>
Was the boiler filled to 17-26 PSI?	<input type="checkbox"/>	<input type="checkbox"/>
Was the deaeration process performed on the boiler?	<input type="checkbox"/>	<input type="checkbox"/>

12. Operation

Topics in this section

- Start-Up Information
- Control Panel
- Basic Operation Settings
- Parameter Settings
- Outdoor Reset Control
- Air Handler Control
- Bluetooth Low Energy (BLE) and App Instructions
- Diagnostic Codes
- Forced Hi/Low Fire Modes

12.1 Start-Up Information

IMPORTANT

- On initial startup of the system, it is necessary to put the boiler into a deaeration process to remove all air from the system piping and boiler. Failure to properly deaerate the boiler and system may result in damage to the boiler, which is not covered by the boiler warranty.
- It can take up to a week before all the air has disappeared from a newly-filled and pressurized installation. During the first week of operation, noises can be heard which indicate the presence of air. The automatic air vent in the boiler and air separator in the heating system will remove the air, which means the water pressure will reduce some during this period; therefore, additional water is necessary to maintain proper pressure in the heating system. Water pressure needed for operation:
 - The boiler is in normal operation between 17 - 26 PSI.
 - Below 7.3 PSI, the boiler will have an error code (E430 diagnostic code will be present on the controller display) and will not operate. Increasing the heating system water pressure is necessary for operation.
 - Between 7.3 - 13 PSI, operation will be limited (E430 diagnostic code will be present on the controller display).
 - The maximum pressure permitted inside the heat exchanger is 45 PSI.
 - The pressure relief valve supplied with the boiler is rated to 30 PSI.

12.2 Control Panel

12.2.1 Control Panel Feature

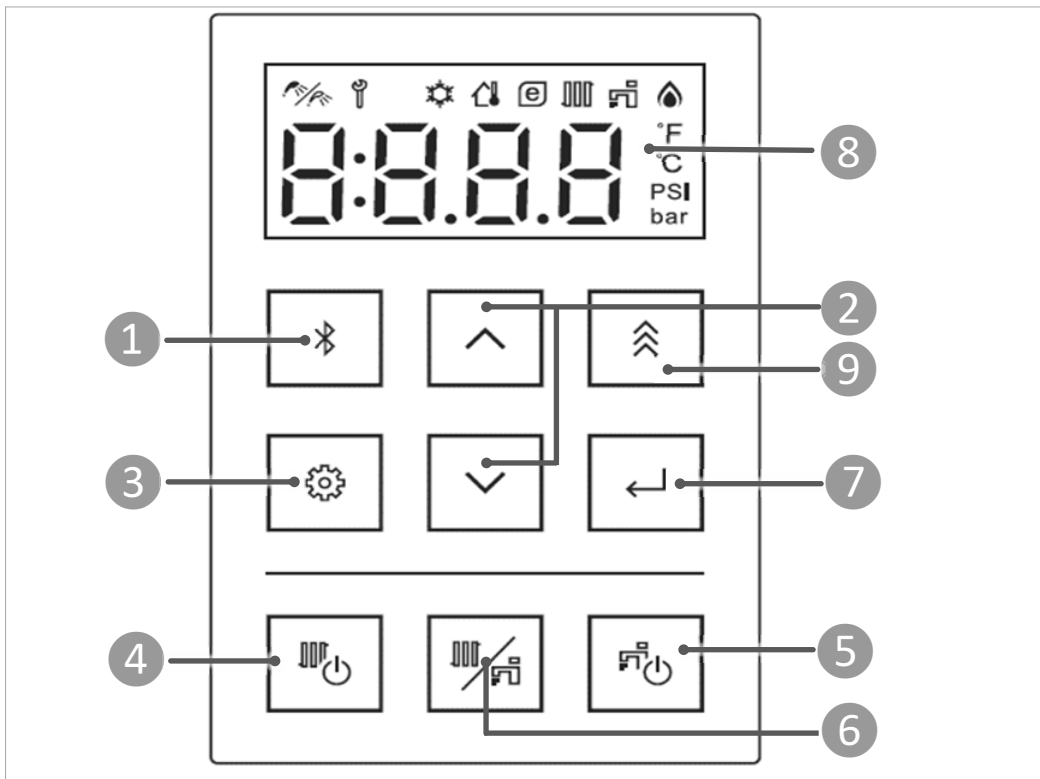

Figure 79

- 1 Bluetooth**
Connects for BLE setup.
- 2 Up/Down Arrows**
Scrolls through available menu options including adjusting the temperature.
- 3 Settings Menu**
Selects Further Menus to adjust settings.
- 4 Central Heating (CH)**
Press to run the boiler in Central Heating mode.
- 5 Domestic Hot Water**
Press to run the boiler in Domestic Hot Water Indirect Tank mode.
- 6 Switch Operation Mode**
Press to change the display between DHW and CH for temperature setting.
- 7 Select Button**
Press to select the option in the display window.
- 8 Display Window**
Displays boiler status information.
See section “12.2.2 Display Window” for more information.
- 9 Boost Button**
Engages the Boost Function on the boiler.

12.2.2 Display Window

When the boiler is turned on, the main screen (also called the home screen) appears in the display.

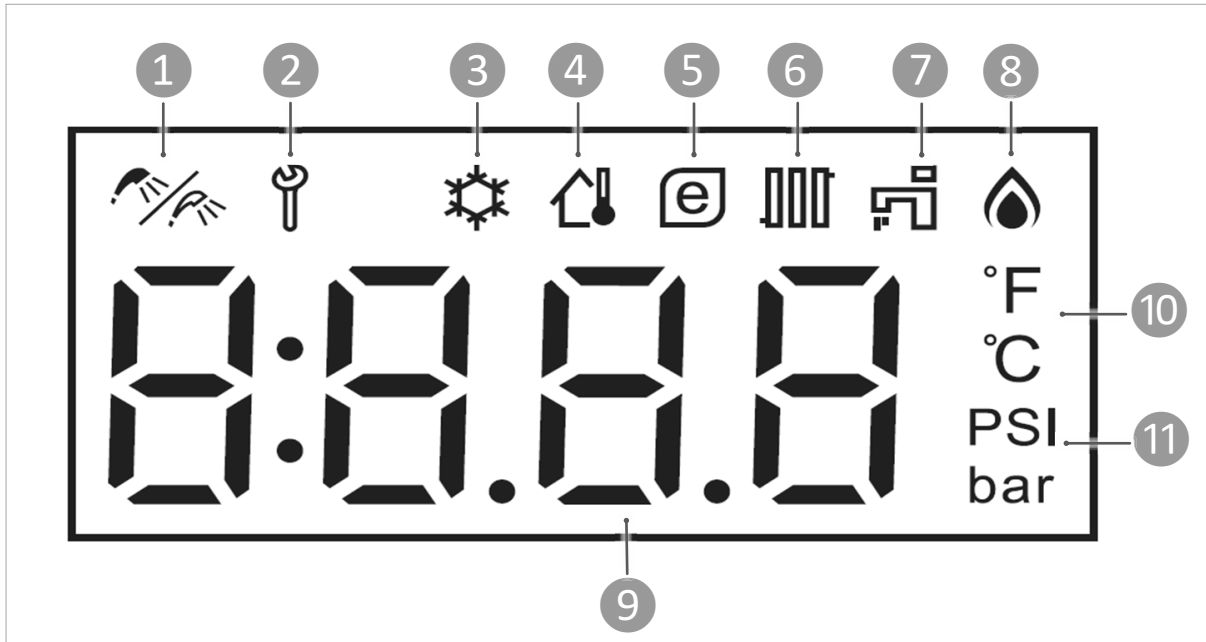

Figure 80

- | | |
|--|--|
| <p>1 Priority Icon
This icon will be present on the controller that has priority.</p> <p>2 Maintenance Mode Icon
Appears when the boiler is in Parameter Settings Mode, Deaeration Mode, Performance Data Mode, Error History Mode, etc.</p> <p>3 Freeze Protection Active</p> <p>4 Outdoor Temperature Sensor Connected</p> <p>5 Eco Mode Active</p> <p>6 Central Heating Mode Active</p> | <p>7 Domestic Hot Water Indirect Tank Mode Active</p> <p>8 “In Use” Light (boiler has fired and is running)</p> <p>9 Setpoint Temperature, Current Temperature or Current Pressure, and Diagnostic Information
Note: Pressure and temperature are alternately displayed on the controller.</p> <p>10 Unit of Measurement for Temperature</p> <p>11 Unit of Measurement for Pressure
Note: Pressure and temperature are alternately displayed on the controller.</p> |
|--|--|

12.3 Basic Operation Settings

12.3.1 Central Heating Setpoint Temperature

The Central Heating (CH) setpoint temperature is not adjustable in outdoor reset control unless the custom heating curve (Curve 4) is selected.

If Parameter \square is set to “d” (Curve 4), follow the steps below to change the CH target temperature.

For more information, see section “12.4.1 Parameter Settings Table” > Parameter \square > Selection “H” (Curve 7).

Table 34

Parameter	Setting Description	Selection						
		A	b	C	d	E	F	H
\square	Outdoor Reset Curve Select the proper curve from below. See section “12.5.4 Outdoor Reset Curves” for more information. Curve 1: Standard baseboard, high-efficiency air handler, panel radiators Curve 2: Staple up radiant. Curve 3: High temperature air handler or undersized baseboard. Curve 4: Cast Iron Baseboard Curve 5: Radiators Curve 6: High Mass Radiant Curve 7: Custom curve based on customer input	Curve 1	Curve 2	Curve 3	Curve 4	Curve 5	Curve 6	Curve 7

IMPORTANT

- When outdoor reset control activates, the target supply temperature for the CH system will not follow the target temperature set on the controller.
- When the boiler is in operation, pressure and temperature are alternately displayed on the controller.

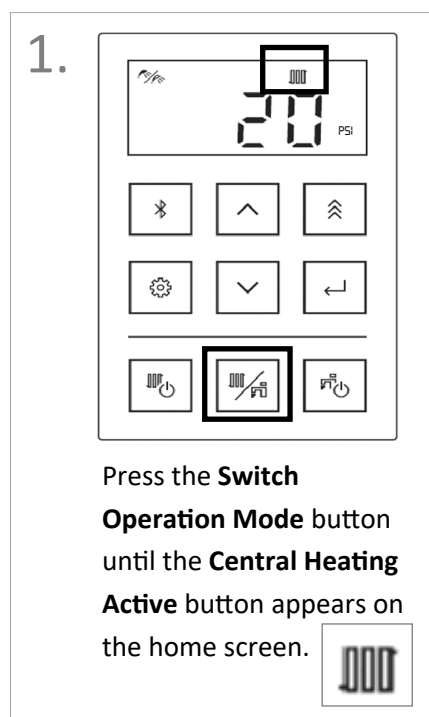

Figure 81

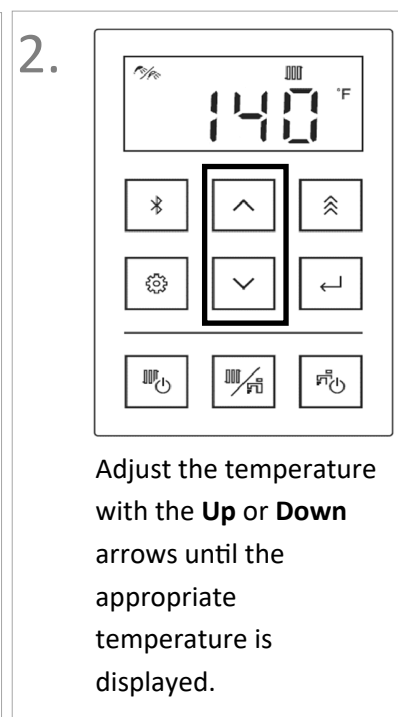

Figure 82

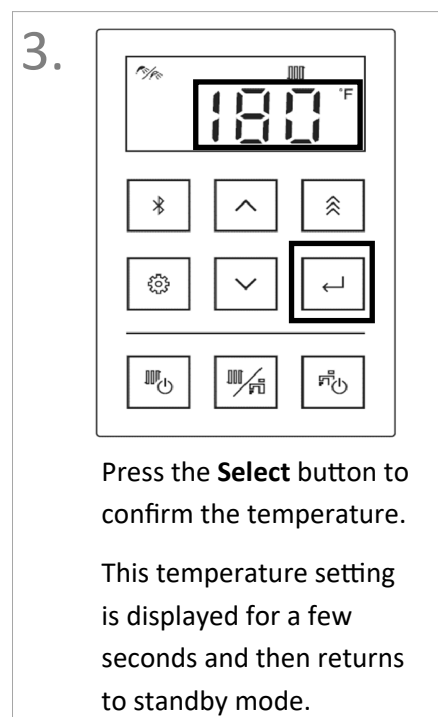



Figure 83

12.3.2 Indirect Tank DHW Setpoint Temperature

When the indirect tank is connected to the boiler PC board, the indirect tank setpoint temperature can be adjusted via the controller (this is applicable only when using the indirect tank thermistor).

To adjust the indirect tank DHW setpoint temperature, follow the steps below.

1.



If the backlit LED of the **DHW** button is not illuminated, press the **DHW** button.

If the backlit LED of the **DHW** button is illuminated, proceed to Step 2.

2.

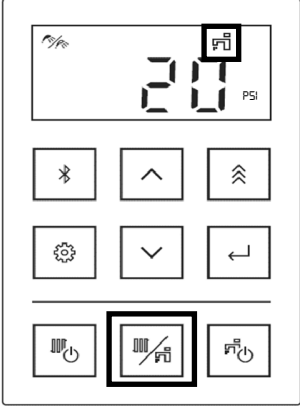

Press the **Switch Operation Mode** button until the **DHW Active** icon appears on the home screen.

3.

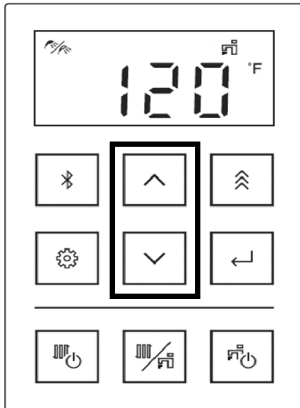

Adjust the temperature with the **Up** and **Down** arrows until the appropriate temperature is displayed.

4.

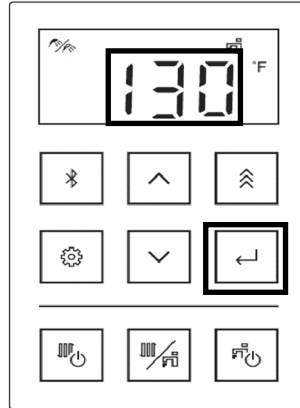

Press the **Select** button to confirm the temperature.

This temperature setting is displayed for a few seconds and then returns to standby mode.

Figure 84

Indirect Tank Temperature Settings

Temperature	120°F (50°C)	130°F (55°C)	140°F (60°C)	150°F (65°C)
--------------------	--------------	--------------	--------------	--------------

12.3.3 Central Heating Eco Mode

Central Heating Mode is a gas-saving function available on the I-Series Heat-Only (Solo) Boilers.

- **Eco Mode (Default) (Eco icon illuminates)**

If it is desired to reduce the amount of gas used in CH operation, Eco mode will turn the space heating off when the return water temperature is close to the target setpoint temperature for five minutes every 15 or 30 minutes depending on the setting of Parameter 48.

- **Comfort Mode (Eco icon does not illuminate)**

The boiler will operate via a call for heat from the thermostat or the heating need for the CH button dependent on the selection made on parameter 61. This mode will use more gas but will provide a more consistent home heating temperature.

By default, Eco mode is enabled (turned on). To enable (turn on) comfort mode, follow the steps below.

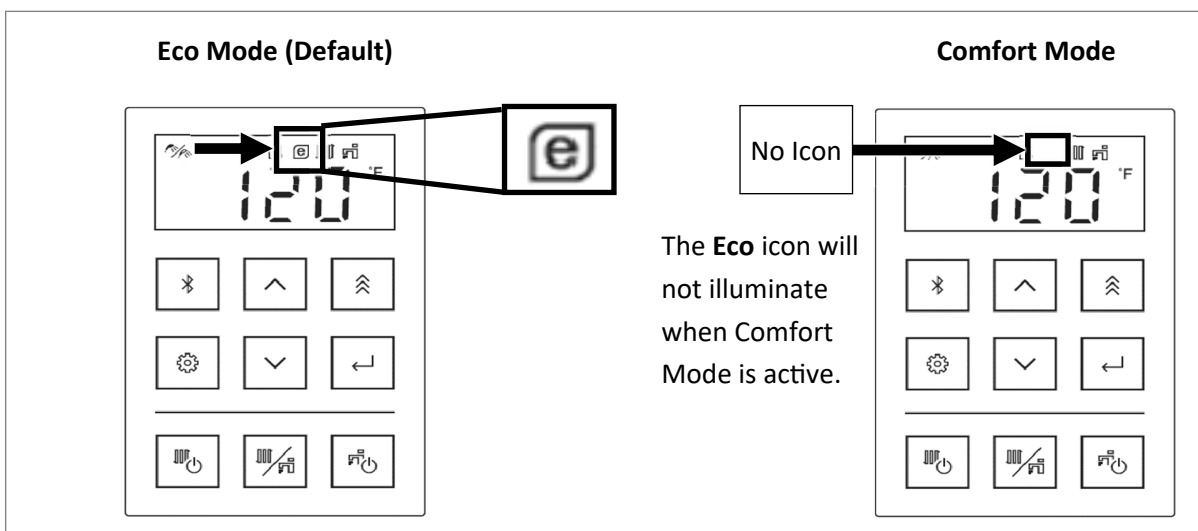

Figure 85 (A)

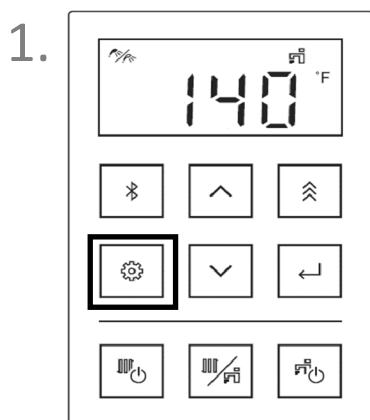

Figure 85 (B)

Press the **Settings Menu** button four times.

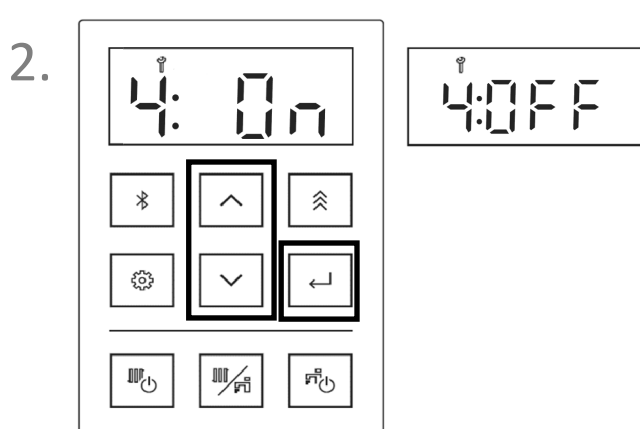

Figure 85 (C)

Press the **Up** or **Down** arrows to select the mode, and press the Select button.

- **On** = Eco Mode Active
- **OFF** = Comfort Mode Active

12.3.4 Units of Measurement

To change the units of measurement appearing on the boiler display, follow the steps below.

1.

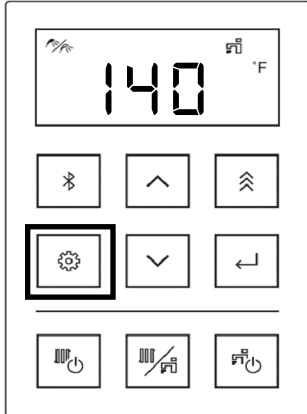

Figure 86

Press the **Settings Menu** button.

2.

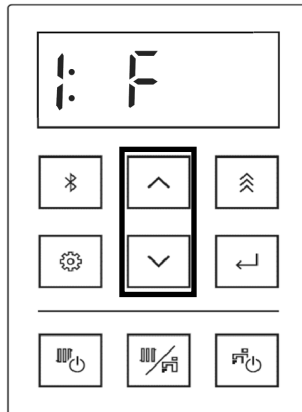

Figure 87

Press the **Up** or **Down** arrows to select a unit.

- **F** = U.S. Measurement (°F/PSI)
- **C** = Metric (°C/bar)

3.

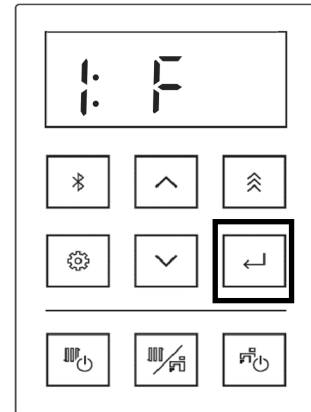

Figure 88

Press the **Select** button.

12.3.5 Control Panel Sound

To turn the control panel click sound on or off, follow the steps below.

1.

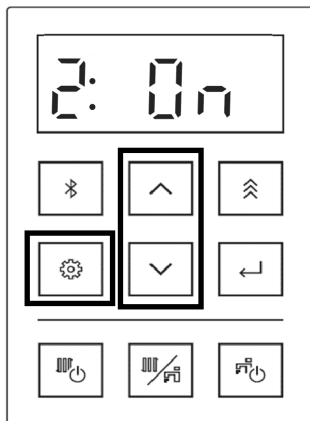

Figure 89

Press the **Settings Menu** button twice.

2:On should appear on the display.

Press the **Up** or **Down** arrows to select ON or OFF.

2.

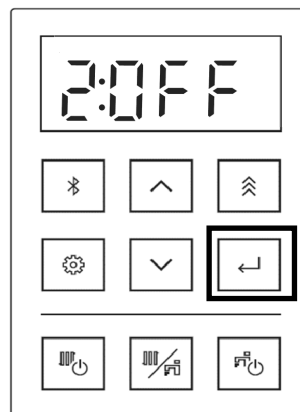

Figure 90

Press the **Select** button.

12.3.6 Child Lock

To turn the child lock function on or off, follow the steps below.

▶ IMPORTANT

- When Child Lock mode is enabled, the only function available is to turn off Central Heating (by pressing the **Central Heating** button on the controller); this occurs only if Parameter 11 is set to “b”. See section “12.4 Parameter Settings” for more information.
- If using multiple controllers, Child Lock can be set only on the controller that has priority.
- If a button is pressed when the Child Lock function is engaged, “LOC” will be displayed on the controller.

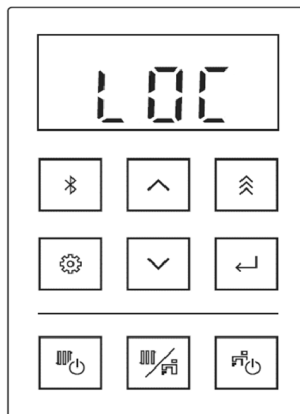

Figure 91

1.

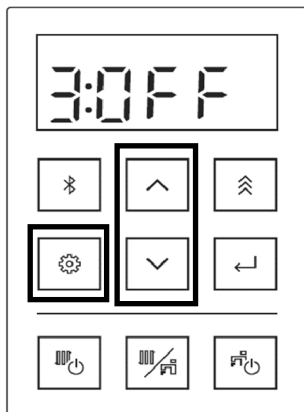

Figure 92

Press the **Settings Menu** button three times. 3:0FF should appear on the display. Press the **Up** or **Down** arrows to select:

- OFF - Child Lock OFF
- LOC - Child Lock ON

2.

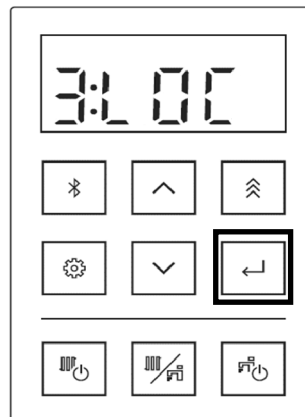

Figure 93

Press the **Select** button.

12.3.7 Performance Data

To view the boiler's performance data, follow the steps below.

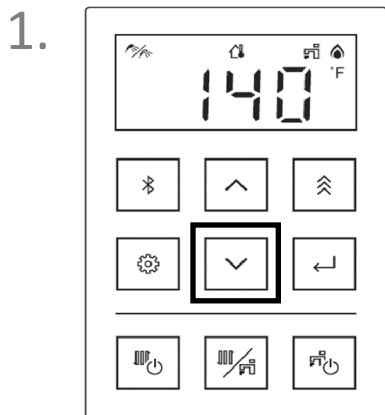

Figure 94

Press and hold the ▼ (Down) button for two seconds.

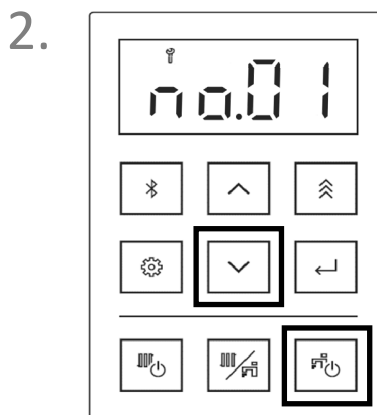

Figure 95

While continuing to hold the ▼ (Down) button, press and hold the **Domestic Hot Water** button (press and hold both buttons down at the same time).

3.

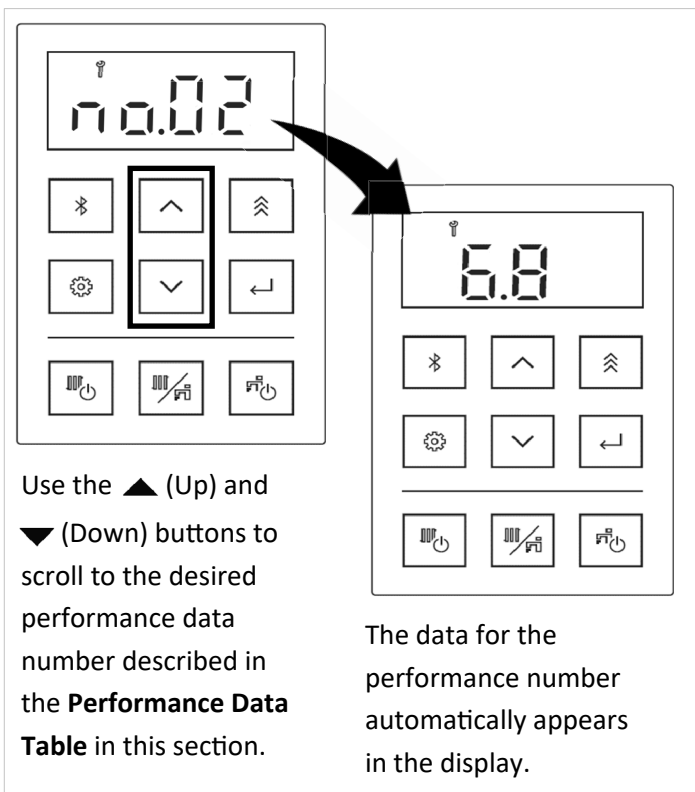

Figure 96

4. To exit performance data:

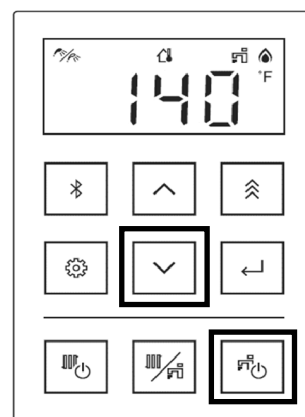

Figure 97

While continuing to hold the ▼ (Down) button, press and hold the **Domestic Hot Water** button (press and hold both buttons down at the same time).

Performance Data Table



IMPORTANT

Unit of measurement (°F/°C, PSI/bar, and GPM/LPM) will vary depending on unit of measure selection.

Table 35

#	DATA	UNIT
01	Water Pressure	PSI/bar
03	Supply Temperature	°F/°C
04	Return Temperature	°F/°C
05	Freeze Protection Temperature	°F/°C
06	Exhaust Temperature	°F/°C
11	Fan Frequency	Hz
17	Venturi Position	0=Closed, 1=Open
18	Venturi Cycles	x100
20	Pump Cycles	x100
21	Pump Hours	x10 Hours
22	Pump for Boiler	0=OFF, 1=ON
23	Pump for System (Pumps 1-3)	0=OFF, 1=ON
24	Pump for System (Pump 4)	0=OFF, 1=ON
30	Indirect Tank Thermistor Temperature	°F/°C
31	Outdoor Temperature	°F/°C
40	Energization Hours	x100 Hours
41	Combustion Hours	x10 Hours
42	Combustion Cycles	x100
45	Commissioning Cycles	x1

* Refer to the Technical Data Sheet located on the inside front cover of the boiler for additional information.

12.3.8 PC Board Buttons

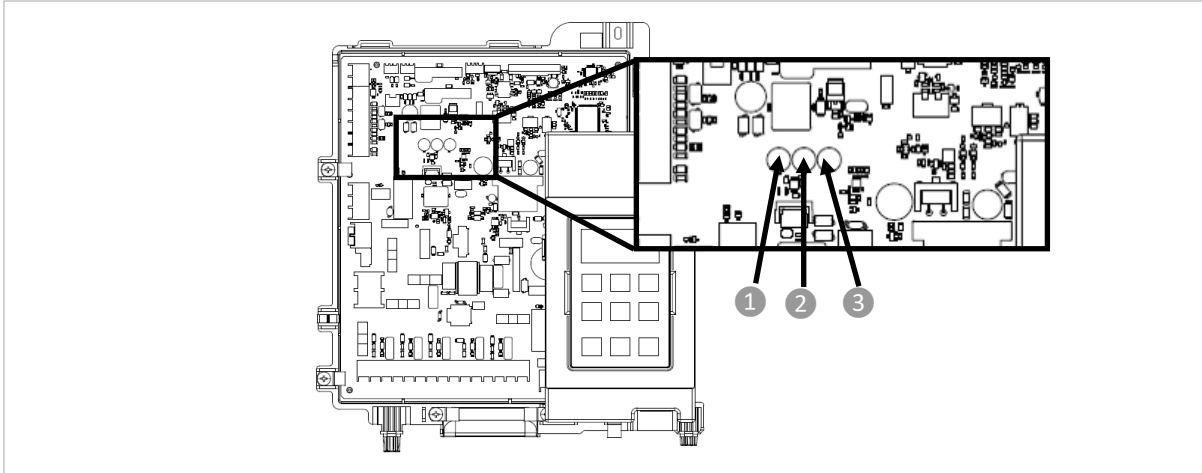

Figure 98

Table 36

Item #	PC Board Switch	Primary Function	Notes
1	Button 1	Parameter Setting Mode	Refer to section "12.4 Parameter Settings."
2	Button 2	Deaeration Mode	Refer to section "10. Commissioning"
3	Button 3	Data Transfer Mode/Test Combustion Mode/Flushing Mode	This is for transferring PCB data when replacing the PCB. Refer to the instructions included in the replacement parts. Also, this is used for setting the boiler into forced combustion mode and flushing mode.

12.3.9 Altitude

To change the altitude, follow the steps below.

1. Remove the boiler's front panel by removing the two screws that secure the panel.
2. Locate the PC Board (lower left side of unit) (see below).
3. Locate the PC Board buttons on the PC Board (see below).
4. Press and hold the SW1 left button on the PC Board (see below).
5. Scroll to Parameter R3. Adjust Parameter R3 based on the altitude settings in the table below.

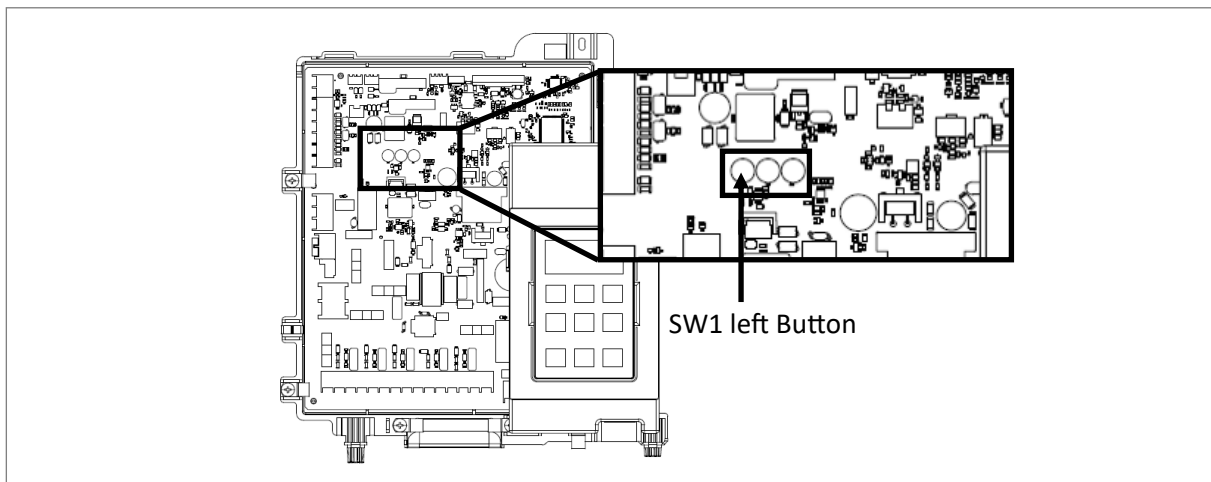

Figure 99

Table 37

Parameter Number	Parameter Title	Setting			
		A	B	C	D
R3	Altitude	0-2,000 ft (0-610 m)	2,001-5,400 ft (610-1,646 m)	5,401-7,700 ft (1,646-2347 m)	7,701-10,200 ft (2,347-3,109 m)

→ IMPORTANT

When a PC Board button is adjusted, it is not necessary to adjust the gas pressure setting for high altitude.

12.4 Parameter Settings

- 1 Remove the boiler's front panel by removing the two screws that secure the panel.
- 2 Locate the PC Board (lower left side of unit).
- 3 Locate the left PC Board button.
- 4 Press and hold the button for five seconds.

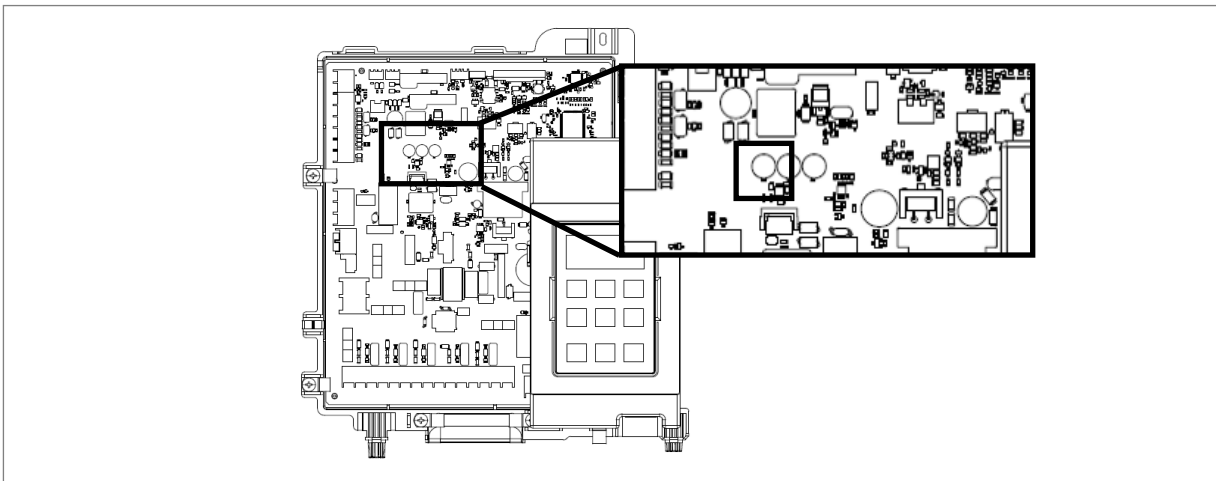

Figure 100

5. 00-R appears on the display.

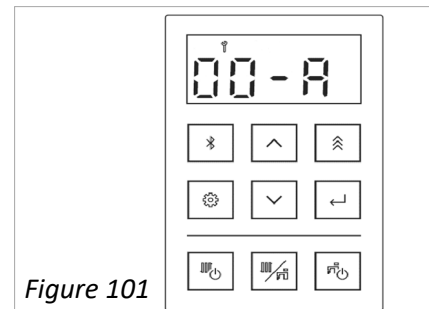

Figure 101

6. Press the ▲ (Up) or ▼ (Down) arrows to select a parameter setting number. Then, press the **Select** button.

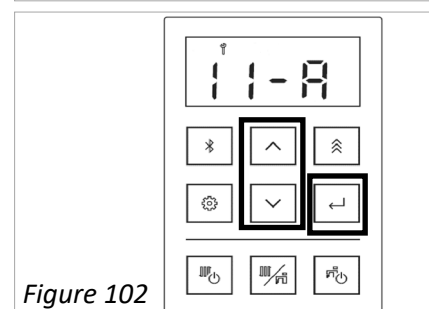

Figure 102

7. Press the ▲ (Up) or ▼ (Down) arrows to change the selection for the setting number (such as 11-R or 11-b). Then, press the **Select** button.

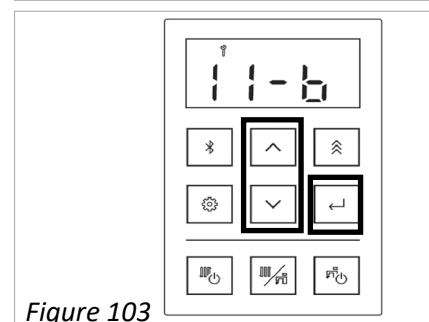

Figure 103

8. To exit parameter settings and enter normal operation mode, press the PC Board button.

12.4.1 Parameter Settings Table

Table 38

		Selection							
Parameter Number	Function/Description	A (Default)	b	C	d	E	F	H	
00	Outdoor Temperature Sensor Enables or disables the outdoor temperature sensor.	In Use	Not In Use						
01	Outdoor Reset Curve (*) This parameter shows up only when selecting Outdoor Temperature Sensor "In Use" as selecting parameter number 00. For selecting outdoor reset curve, see below: Curve 1: Standard baseboard, high-efficiency air handler, panel radiators Curve 2: Staple up radiant. Curve 3: High temperature air handler or undersized baseboard. Curve 4: Low Mass Radiant Curve 5: Radiators Curve 6: High Mass Radiant Curve 7: Custom curve based on customer input	1	2	3	4	5	6	7	
02	Boost This parameter is available when parameter number 00 is selected as "A." Boost Mode increases the CH set temperature above the outdoor reset curve target when the boiler has been running on an unusually long call for heat.	30 Minutes	60 Minutes						
03	Maximum Outdoor Temperature This parameter is available when parameter number 00 is selected as "A." This sets the maximum outdoor temperature the boiler will fire in CH mode. This can prevent the boiler from firing in warm outdoor temperatures.	No Maximum	77°F (25°C)						
04	Service Soon SS is a time based service indicator set during installation.	Disabled	0.5 Year						1 Year
05	Pressure Indication on Controller Panel The current pressure will cycle on the controller display. If an external pressure gauge is present, it is permissible to change the setting to "No."	Yes	No						
06	De-Rate This parameter is to limit maximum input when it is necessary.	No	Setting 1						Setting 2
28	Indirect Tank Enables the Indirect Tank Function for Pump 4.	On	Off						

12.4.1 Parameter Settings Table (Continued)

Table 38 (Continued)

Parameter Number	Function/Description	Selection			
		A (Default)	b	C	d
29	Indirect Tank Thermistor/Thermostat Selection Selects the method of controlling the indirect tank.	Thermostat	Thermistor		
30	Indirect Tank Supply Temperature with Thermostat Control This parameter is available when parameter number 28 is selected as "A" and parameter number 29 is selected as "A." This selects the supply temperature for the indirect tank when using a thermostat. 180°F (82°C) (Default) is the maximum supply temperature. The higher the supply temperature to the tank, the quicker the tank will heat up. If this temperature is too high, select other settings as appropriate. Ensure the indirect tank supply temperature is 18°F (10°C) higher than the set point temperature of the tank thermostat.	180°F (82°C)	160°F (71°C)	140°F (60°C)	
	Indirect Tank Supply Temperature with Thermistor Control This parameter is available when parameter number 28 is selected as "A" and parameter number 29 is selected as "b." This selects the supply temperature for the indirect tank when using a thermostat. 180°F (82°C) (Default) is the maximum supply temperature. The higher the supply temperature to the tank, the quicker the tank will heat up. If this temperature is too high, select other settings as appropriate.	180°F (82°C)	Tank Setting Temperature +18°F (10°C)	Tank Setting Temperature +27°F (15°C)	
31	Allowed indirect tank temperature drop before firing (with thermistor) This parameter is available when parameter number 28 is selected as "A" and parameter number 29 is selected as "b." This selects the differential temperature between the indirect tank setpoint temperature and thermistor reading. The smaller the value, the more frequently the indirect tank will call for heat.	5.4°F (3°C)	10.8°F (6°C)	16.2°F (9°C)	21.6°F (12°C)
32	Indirect Tank Operation Option This parameter is available when parameter number 28 is selected as "A." When a 3-Way Valve and the boiler pump are to be used for recovering the indirect tank, select "b". Only 120 VAC 3-Way Valves may be used in this application.	Use Pump	Use 3-Way Valve		

12.4.1 Parameter Settings Table (Continued)

Table 38 (Continued)

Parameter Number	Function/Description	Selection			
		A (Default)	b	C	d
33	<p>Indirect Tank Simultaneous Heating-Up</p> <p>This parameter is available when parameter number 28 is selected as "A" and parameter number 32 is selected as "A." This selects the operation of the indirect tank heating by priority or simultaneously with CH. When "Indirect Tank Priority" is selected, other pumps except for the indirect tank pump will not operate while the tank is being heated. When "Simultaneous Heating with Indirect Tank and CH", all pumps may operate simultaneously. When in Simultaneous mode, if the tank does not achieve the Indirect Tank Setpoint Temperature within 60 minutes, it will transition to Indirect Tank Priority.</p>	Indirect Tank Priority	Simultaneous Heating with Indirect Tank and CH		
34	<p>Indirect Tank Priority Time</p> <p>This parameter is available when parameter number 28 is selected as "A." This selects the time that the indirect tank will maintain priority. After this period of time passes, the indirect tank will cease to be heated and central heating will have priority. If there is still an indirect tank demand after 60 minutes passes of CH priority, indirect tank priority will begin again.</p>	60 Minutes	40 Minutes	90 Minutes	
35	<p>CH Temperature Limitation to Allow Simultaneous Operation with Indirect Tank</p> <p>This parameter is available when parameter number 28 is selected as "A," parameter number 32 is selected as "A" and parameter number 33 is selected as "b."</p> <p>This enables CH setting limitation during simultaneous heating. This can prevent unintentionally supplying high temperature supply water to low water heating temperature applications such as floor heating. During simultaneous operation, the heating supply temperature is based on the indirect tank supply temperature. When "NO" is selected, make sure that the CH system and heating application is designed to allow for the high supply temperature.</p>	Yes	No		
40	<p>Linked Operation Among Each CH Pumps</p> <p>This parameter enables linked operation among each CH pumps. For example, when parameter b is selected and T/T 1 is active, both pump 1 and 2 are ON. The T/T wire must be connected to the T/T1 connection. This setting is primarily for an application that requires two pumps or more for one zone, such as in use with an injection loop or similar system.</p>	No	Linked Together CH pump 1 and pump 2	Linked Together CH pump 1, pump 2 and pump 3	Linked Together CH pump 1, pump 2, pump 3 and pump 4

12.4.1 Parameter Settings Table (Continued)

Table 38 (Continued)

Parameter Number	Function/Description	Selection		
		A (Default)	b	C
41	<p>Linked Operation Between Main Boiler Pump and CH Pump 1</p> <p>This enables the linked operation between the main boiler pump and CH pump 1. For example, when the main pump is on, pump 1 is also on.</p>	No	Yes (Linked together)	
42	<p>Main Pump Runs When the Target Temperature is Reached</p> <p>This selects the mode of the main pump running when the target setpoint is achieved. This setting is for whether running on intervals to reduce pump operation or continuously running to reduce wait time to re-fire. Intervals are 10 minutes ON and 30 minutes OFF.</p>	Continuously	Intervals	
43	<p>External Pump Runs When the Temperature is Reached</p> <p>For selecting the mode of external pump running when the temperature is reached to setting. This is setting for whether stopping external pump running to reduce pump operation timing or operating as same as main pump operation to enable to deliver remained heat in heat exchanger</p>	Same as main Pump	Does Not Run	
44	<p>External Pump Running at Freeze Protection Operation</p> <p>For selecting the mode of external pump running when the freeze protection operation. This is setting for whether stopping external pump running to reduce pump operation timing or operating as same as main pump operation to enable to deliver remained heat to the system for keeping the system piping from freezing. But it could reduce the temperature of inside of heat exchanger.</p>	Does Not Run	Same as Main Pump	

12.4.1 Parameter Settings Table (Continued)

Table 38 (Continued)

Parameter Number	Function/Description	Selection			
		A (Default)	b	C	d
45	Freeze Protection Level This selects the freeze protection level. Selecting “b” will prevent the boiler from operating in freeze protection mode more than believed necessary.	Normal	For warm room temp		
46	The Differential Temperature From Extinguishing Fire to Fire Again How much temperature drop is permitted by the supply water thermistor before the boiler will fire again. When selecting “Quick”, the boiler will fire more frequently and achieve more temperature control	Normal	Quick		
	CH Setting Temperature	Temperature Drop	Temperature Drop		
	168°F -182°F (75-82°C)	27°F (15°C)	15°F (8°C)		
	104°F -166°F (40-74°C)	15°F (8°C)	9°F (5°C)		
47	The Time Which Not Allow to Fire Again for CH For selecting time which not allow to fire again for CH after shutdown burner. This is setting for whether preventing from frequently operating unit or allowing frequent operation for quick heating up again.	Normal (3 Minutes)	Quick (10 Seconds)		
48	Heating Eco Mode On Time This setting changes the on time of the heating Eco mode. This mode enables greater energy savings by reducing the length of time the boiler is operating. The output temperature of the boiler is slower in this mode.	30 Minutes	15 Minutes		
50	Air Handler Connection The setting changes to enable to AH output with linking pump 3.	No	Yes		
51	Air Handler Post Pump Extension Setting Extending the post Pump timing of pump 3.	15 Seconds	40 Seconds		
60	N/A Manufacture Use Only	For Manufacturer Use Only			

12.4.1 Parameter Settings Table (Continued)

Table 38 (Continued)

		Selection					
Parameter Number	Function/Description	A (Default)	b	c	d	E	F
R1	Thermostat Usage Changes the mode between Thermostat Usage and Central Heating Button	Thermostat Used	Central Heating ON button used. Boiler fires based on return water temperature				
R2	Gas Type For selecting gas type when conducting gas conversion	Natural Gas	Liquid Propane				
R3	Model Manufacture Use Only	For Manufacture use Only					
R4	Vent Material Used This selects the venting material used. The boiler is set from the factory to be installed in a PVC venting system. If CPVC, PP, or other approved venting is used, this may be adjusted. See the section on PVC Safety Switch for more information.	PVC	Material other than PVC: <ul style="list-style-type: none"> • CPVC • PP • Other 				
R5	Altitude Setting Sets the elevation of the boiler installation.	Level 0 0-2,000 ft (0-610m)	Level 1 2,001-5,400 (610-1646m)				

12.4.2 Service Indicator (Service Soon, 55)

This boiler includes a service indicator (Service Soon, 55). When selected in the parameter settings, an 55 code will display on the controller indicating that it is time to flush and service the boiler.

- Selection is installers preference based on water conditions or other factors that may influence the suggested interval of service.
- See the “Parameter Settings” section of this manual for selectable service intervals.
- If Service Soon (55) appears on the controller display, contact your local service provider to flush and service the boiler.
- Service Soon will appear again based on the selected service interval.

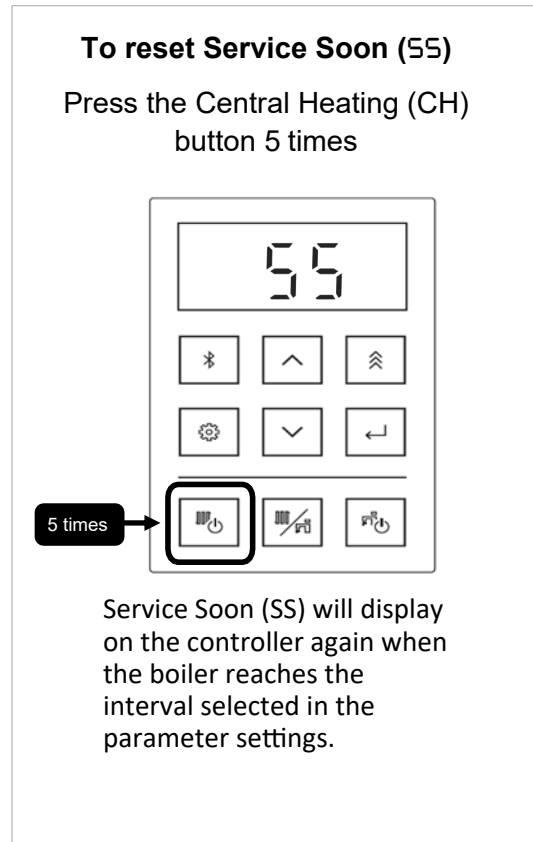

Figure 104

12.5 Outdoor Reset Control

Outdoor reset is a built-in function to help maximize the efficiency of the boiler. The design of this function is to adjust the target temperature of the boiler relative to the outdoor ambient temperature via the seven outdoor reset curve options included in the boiler parameters. The outdoor ambient temperature is observed via the provided outdoor temperature sensor.

12.5.1 Outdoor Temperature Sensor

The outdoor temperature sensor should be mounted on a North facing wall of the house below an eave to avoid direct sunlight (to prevent obtaining a false reading of the outdoor temperature). The sensor should also be mounted away from any vent, duct, or other device that may create an artificial heat source. The sensor should then be wired back to the outdoor temperature sensor terminal on the boiler. Refer to the following sections for more information.

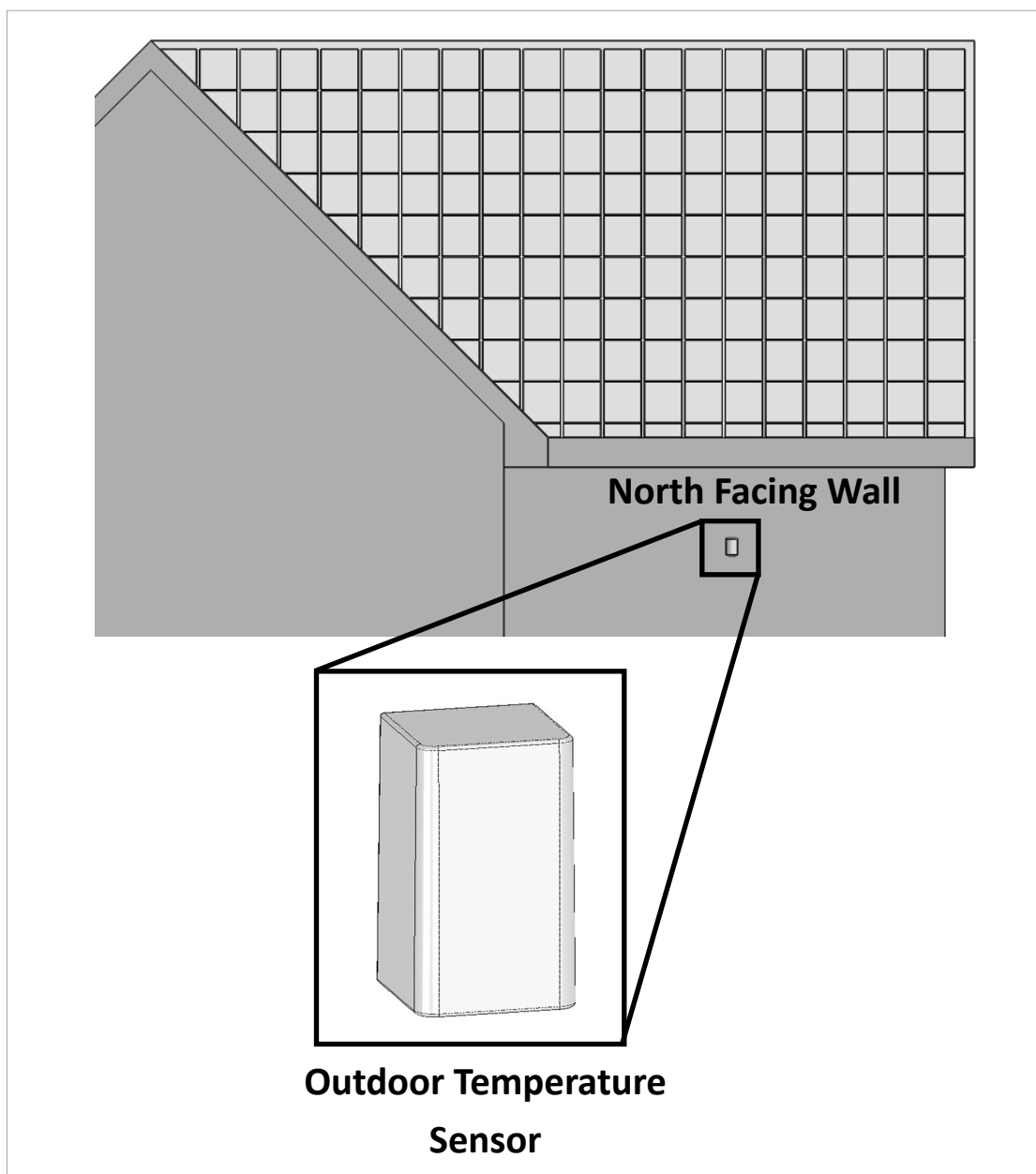

Figure 105

12.5.2 Outdoor Reset Connection

1. Remove the boiler's front panel by removing the two screws that secure the panel.
2. Locate the PC Board (lower left side of unit).
3. Connect the outdoor sensor to the terminals shown below using minimum 18 AWG wiring to the two terminals provided in the enclosure.
4. Ensure Parameter 00 is set to "A" (Default). This ensures the boiler will operate based on the outdoor temperature.
5. Set parameters 01-03 as appropriate for your application (see section "12.4.1 Parameter Settings Table" for more information).

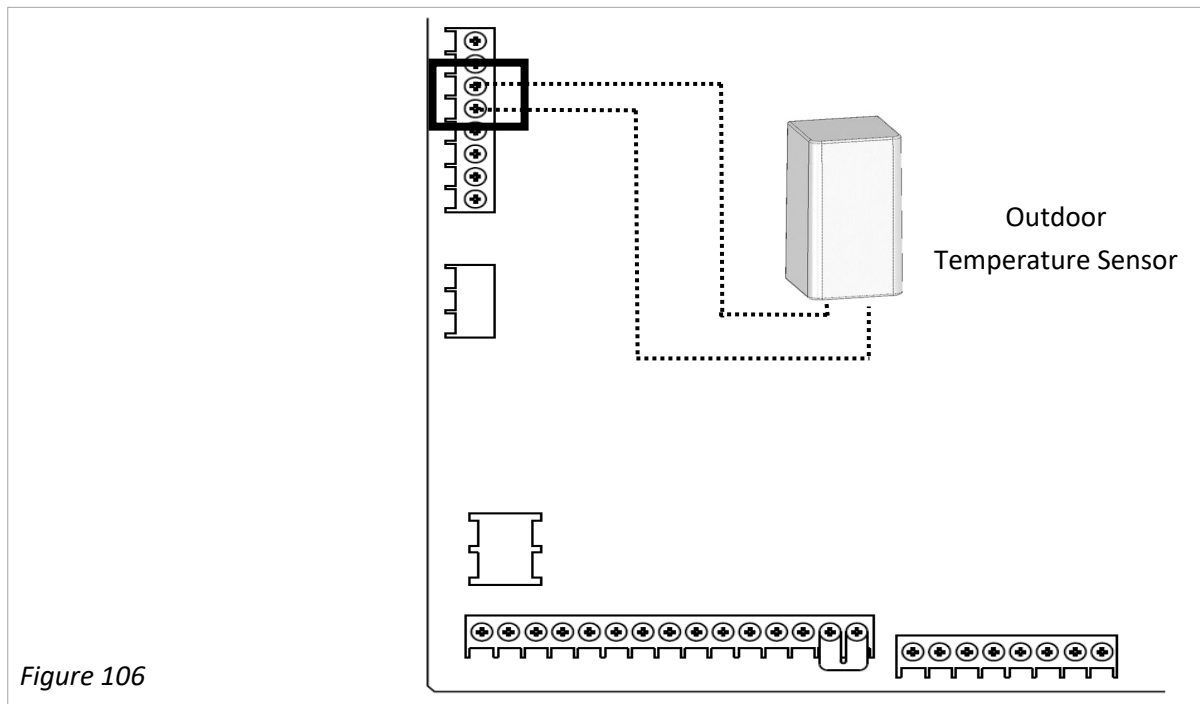

Figure 106



IMPORTANT

If Parameter 00 is set to "A" (default), and the wire harness to the outdoor sensor is disconnected, then error code E393 will display. While the E393 error is displayed, the boiler will operate at the CH setpoint temperature.

12.5.3 Outdoor Reset Curve Temperature Guidelines

Below are some typical target temperatures for various heat emitters. These are basic guidelines; thus, check with the emitter manufacturer or consult your heating design engineer.

Note: If temperatures lower than 104°F/40°C are necessary, a mixing valve may be needed in the system.

Table 39

Type of Heat Emitter	Typical Minimum Supply Temperature	Typical Maximum Supply Temperature
Hydronic Air Handler	120°F - 140°F (49°C - 60°C)	140 °F - 180°F (60°C - 82°C)
Unit Heater	130°F - 140°F (55°C - 60°C)	160°F - 180°F (71°C - 82°C)
Base Board Convectors	100°F - 140°F (38°C - 60°C)	140°F - 180°F (60°C - 82°C)
Cast Iron/Panel Radiator	90°F - 120°F (32°C - 49°C)	140°F - 180°F (60°C - 82°C)
Undermount Radiant	100°F -120°F (38°C - 49°C)	120°F - 150°F (49°C - 66°C)

12.5.4 Outdoor Reset Curves

The boiler has seven outdoor reset heating curves, which are different target temperature lines dependent on the outdoor temperature. The selected curve should be based off of the type of heat emitter and the target temperature desired. The heating curves are described below.

Table 40

Curve Number	Heat Emitter	Maximum Supply Temperature at 14°F (-10°C) Outdoor Temperature	Minimum Supply Temperature at 68°F (20°C) Outdoor Temperature
1 (Default)	Standard baseboard, high-efficiency air handler, panel radiators	180°F (82°C)	122°F (50°C)
2	Staple up radiant	140°F (60°C)	104°F (40°C)
3	High temperature air handler or undersized baseboard	180°F (82°C)	140°F (60°C)
4	Low Mass Radiant	170°F (77°C)	120°F (49°C)
5	Radiators	170°F (77°C)	104°F (40°C)
6	High Mass Radiant	120°F (49°C)	86°F (30°C)
7	Custom curve based on customer input	Setting temperature on the controller	Setting temperature on the controller - 36°F (20°C)

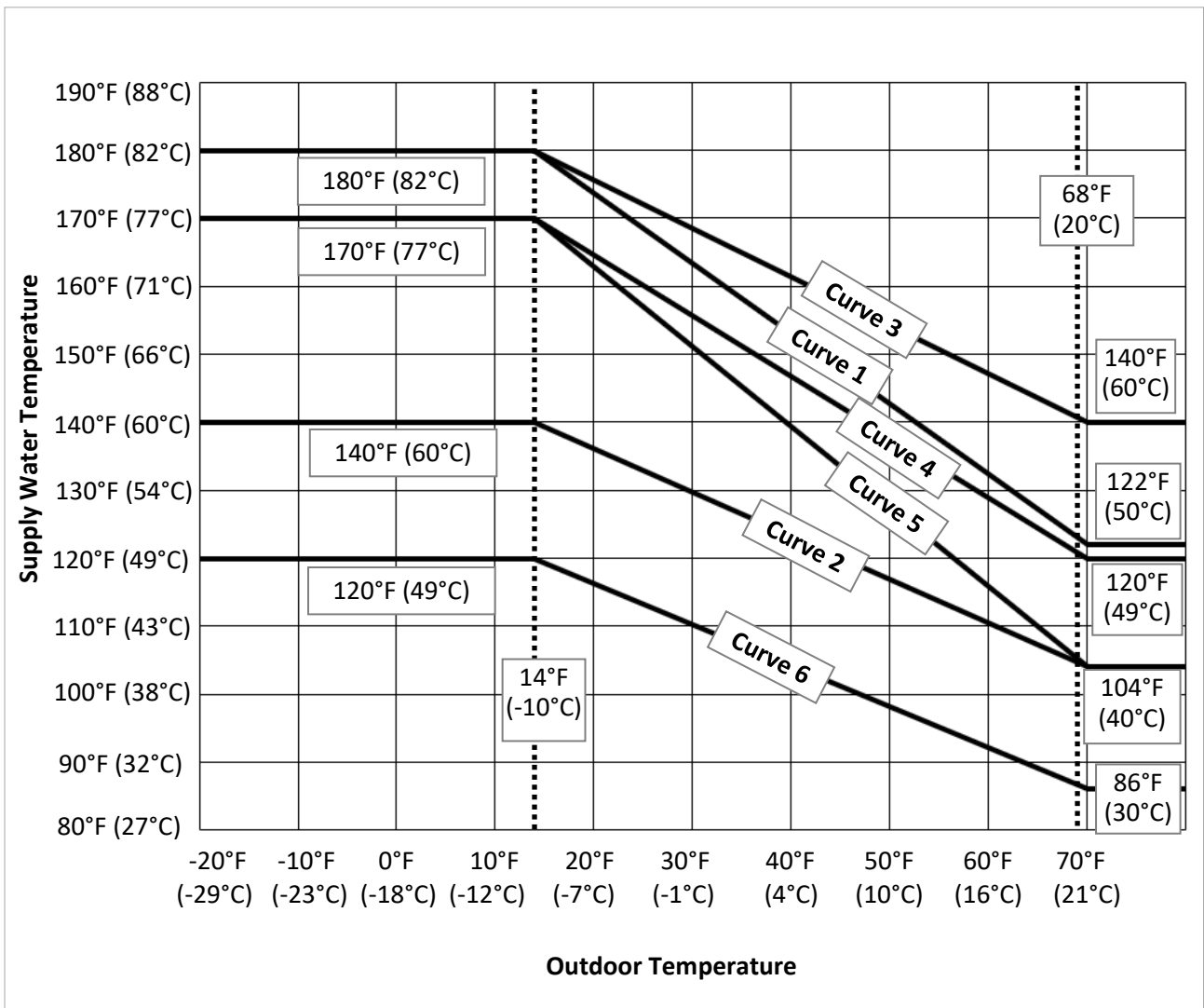

Figure 107

Curve 7

Curve 7 is a custom curve based on the target setpoint temperature of the boiler the customer selects. The maximum temperature is the target temperature. The minimum temperature is 36°F (20°C) lower than the target temperature with a minimum of 86°F (30°C). See example curves below.

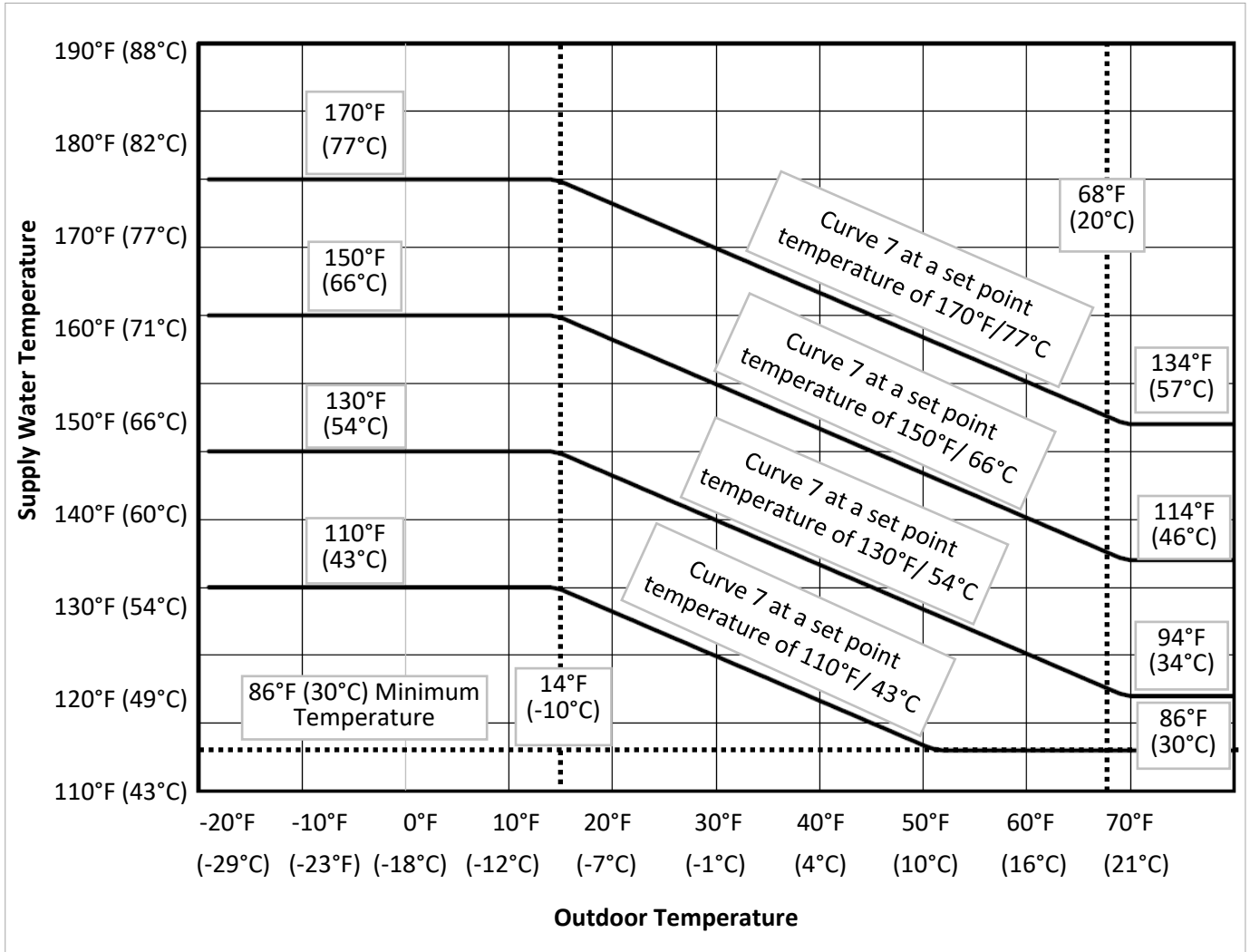

Figure 108

Select Reset Curve

To select the desired reset curve, access the parameters (as shown in section “12.4 Parameter Settings”) and select parameter \square !. Then, select the desired curve.

Table 41

Parameter Number	Setting Description	Selection						
		A	b	C	d	E	F	H
\square !	Outdoor reset curve	1	2	3	4	5	6	7

12.5.5 Boost Mode

Boost mode allows the boiler to override the target temperature determined by the outdoor reset control, and will boost the boiler target temperature to the setting of Parameter 01 after a continuous run time or an interval as selected in Parameter 02. The boost function is active until the call for heat is satisfied or the boiler cycles off.

For example: In the case of selecting curve 1 on parameter number 01 and 30 minutes on parameter number 02, outdoor temperature is 51°F/11°C, and supply temperature is 140°F/60°C. When the boiler continues operating with firing for 30 minutes, the target supply temperature will rise toward 180°F/82°C. This control continues until shut down.

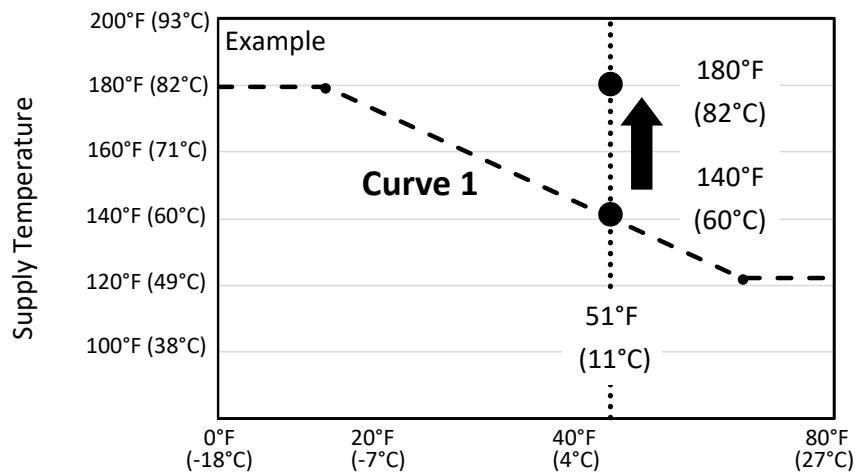

Figure 109

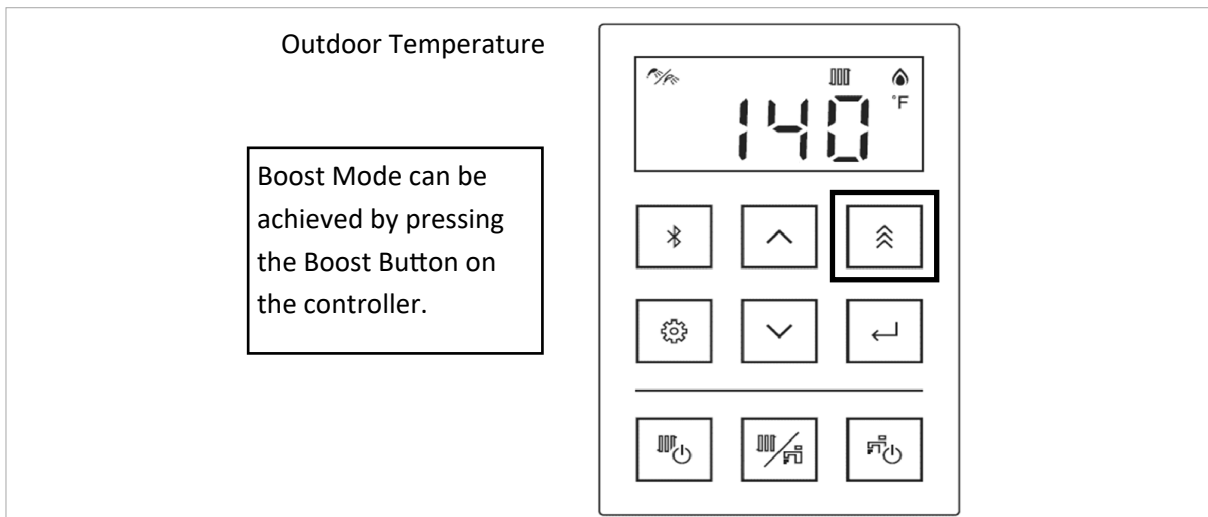

Figure 110

12.5.6 Maximum Outdoor Temperature

The maximum outdoor temperature parameter setting (warm weather shutdown) enables the boiler CH operation to shut down when the outdoor temperature is higher than 77°F (25°C). This mode can prevent the boiler from operating under warm conditions unexpectedly.

Maximum outdoor temperature is selected by setting parameter number 03 to “77°F (25°C)” or “No Maximum” (see section “12.4 Parameter Settings” for more information).

12.6 Air Handler Control

The I-Series Plus Condensing Boiler has the capability to send an output signal to an Air Handler. The zone pump for the air handler must be connected to Pump 3 and the thermostat must be connected to T/T 3.

When selecting parameter 5! as "b" ON, the output signal for air handler operation is available.

Table 42

Domestic Priority/Maintenance Indication Settings			
Switch Configuration	Required Leads/Wires	Function	Function
Air Handler Operation	White/Black	In series with thermostat "W" wire	Normally Closed or Normally Open

The OPU can be set up to operate with the boiler on Zone 3 thermostat connections.

The post pump timer can be selected in parameter 5! (see table below).

Table 43

Parameter	Description	Setting A (Default)	Setting b
5!	Air Handler Post Pump Operation	15 Seconds	40 Seconds

OPU Terminal Connections

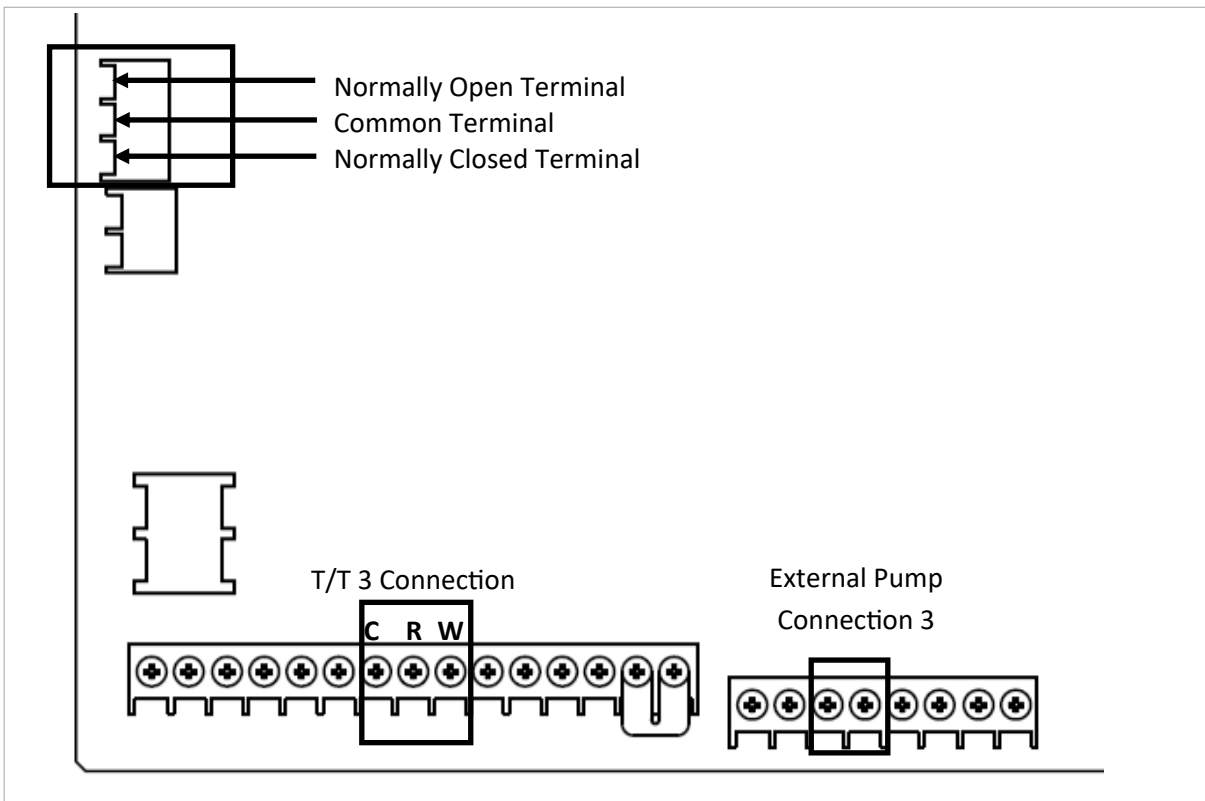

Figure 111

12.7 Bluetooth Low Energy (BLE) and App Instructions

Instructions on this page are correct at the time of publishing; however, these instructions may be updated without notice. To make sure you have the most current instructions, please visit rinnai.us/wifi (for United States installations) or rinnai.ca/wifi (for Canadian installations).

To download the Rinnai Central app:

1. Scan the QR code shown to the right.
2. Download the Rinnai Central app from the app store.

To configure your boiler using the Rinnai Central app:

Note: To use the Rinnai Central app BLE feature with your boiler, your connecting device (smartphone, tablet, computer, etc) must support Bluetooth 4.0 or newer. Contact your connecting device manufacturer if you are not sure if your device supports Bluetooth 4.0 or newer.



1. Press and release the Bluetooth button on the controller. The Bluetooth LED on the controller turns solid white.
2. Log into the Rinnai Central app with a professional account and choose “Connect to a Rinnai Boiler.”
3. The boiler will beep once when pairing is successful. If the pairing mode on the boiler expires without having successfully paired, the boiler will beep twice.
4. Follow the Rinnai Central app through setting up your boiler.

To connect a Rinnai BLE push button to your boiler:

1. Press and hold the Bluetooth button on the controller until the Bluetooth LED on the controller starts blinking.
2. Press and hold the Rinnai BLE push button until the green light flashes. The boiler will beep once when pairing is successful. If the pairing mode on the boiler expires without having successfully paired, the boiler will beep twice. Pressing the Rinnai BLE push button starts recirculation of your boiler.

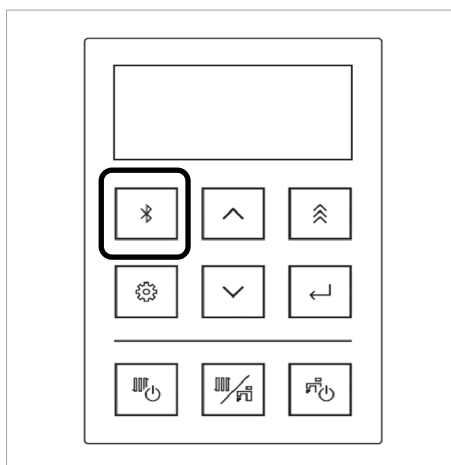

Figure 112

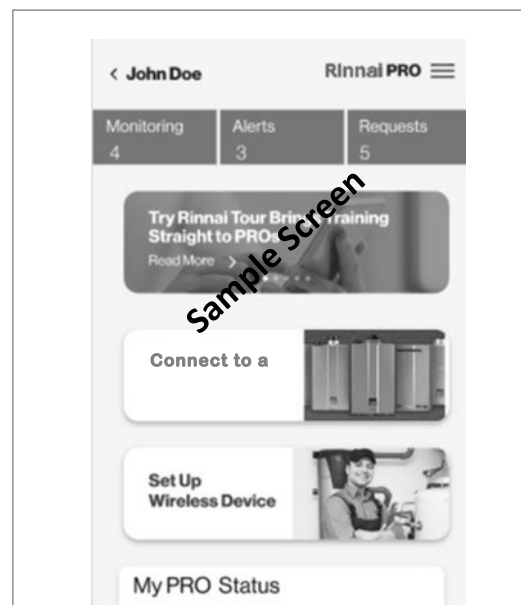

Figure 113

12.8 Diagnostic Codes

WARNING Some of the checks below should be performed by a licensed professional. Consumers should never attempt any action that they are not qualified to perform.

Display Diagnostic Codes

To display diagnostic codes, follow the steps below.

1. Press and hold the **Domestic Hot Water** button for two seconds, and then the ▲ (Up) button (hold both buttons at the same time).
2. The last nine maintenance codes display and flash one after the other.
3. To exit diagnostic codes and return the boiler to normal operation, press and hold the **Domestic Hot Water** button for two seconds, and then the ▲ (Up) button (hold both buttons at the same time).

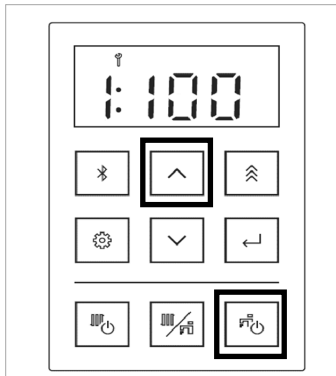

Figure 114

Reset Diagnostic Codes

To reset diagnostic codes, either the **Central Heating** or **Domestic Hot Water** button on the control panel will be blinking. Press the button to reset the code.

IMPORTANT

- Diagnostic codes that occur during DHW operation may be able to reset by turning off the faucet.
- Some diagnostic codes may not reset by pressing the CH or DHW buttons. If this is the case, contact your service provider for troubleshooting assistance.

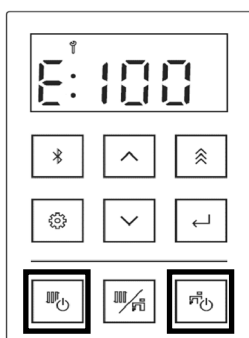

Figure 115

* See “Electrical Diagnostics” on Technical Data Sheet located on inside front cover of boiler.

Diagnostic Codes

Table 44

E:100	Air Supply or Exhaust Blockage/ Condensate Trap is Full
	<ul style="list-style-type: none"> • Fan current initial check error. • Ensure condensate line and trap is not blocked. • Ensure internal air filter is clean with no obstructions. • Ensure high altitude setting is set properly (See High Altitude Setting). • Ensure combustion air and exhaust vents are not blocked and the approved venting materials are being used. • Ensure either the exhaust ring or intake cap is removed properly. • Ensure vent length is within limits. • Check fan for debris and ensure wheel turns freely. • Verify fan check valve is not stuck
E:101	No Ignition (Unit Not Turning On)
	<ul style="list-style-type: none"> • Ignition Error. • Check that the gas is turned on at the boiler, gas meter, and/or propane cylinder. • If the unit is installed in a propane system, ensure that gas is in the tank. • Bleed all air from the gas lines. • Check the ground wire for the PC Board. • Ensure the flame rod wire is connected. • Ensure the igniter is operational.* • Ensure the venting is installed in accordance to this manual. • Check that the surface of the electrode and flame rod are clean. • Check gas solenoid valves for open or short circuits.* • Verify gas orifice installed is correct for the gas system the unit is installed in. • Check flame rod voltage to ground during ignition.

* See “Electrical Diagnostics” on Technical Data Sheet located on inside front cover of boiler.

120	Flame Failure
	<ul style="list-style-type: none"> Boiler has flame failure. Check that the gas is turned on at the boiler, gas meter, and/or propane cylinder. If the unit is installed in a propane system, ensure that gas is in the tank. Ensure the venting is installed in accordance to this manual. Ensure the flame rod wire is connected. Ensure the gas type and inlet gas pressure are correct. Bleed all air from the gas lines. Check the ground wire to the PC Board. Check flame rod voltage to ground during ignition.
140	Heat Exchanger Overheat
	<ul style="list-style-type: none"> Overheat switch is tripped. Measure the resistance of the Overheat Switch.* Check the heat exchanger surface for hot spots which may indicate blockage due to scale buildup. Ensure the boiler pump is not locked up. Ensure that all of the valves in the CH circuit are open. Ensure the boiler and CH circuit does not have a freezing condition. The surface of the heat exchanger may turn to a black color as stainless steel is tempered even in normal conditions. This does not indicate an abnormal condition. Check for damage on the exhaust, seal, and venting.
150	Venturi Control
	<ul style="list-style-type: none"> Venturi operation error. Ensure the venturi motor is operating correctly.* Replace the gas valve assembly.
161	High Outgoing Temperature
	<ul style="list-style-type: none"> Safety shutdown because DHW outgoing temperature is too hot. Check sensor wiring for damage of outgoing thermistor. Measure resistance of outgoing thermistor.* Ensure the gas valve has no damage and the orifice is installed correctly. Replace the gas valve assembly.

* See "Electrical Diagnostics" on Technical Data Sheet located on inside front cover of boiler.

170	Venturi Blockage
	<ul style="list-style-type: none"> Check the venturi and silencer for blockage. Before resetting this error, check if the condensate drain is block and if the venting is connected properly.
180	Gas Valve Adjustment Limit
	<ul style="list-style-type: none"> Ensure gas type is correct. Ensure the ground from PCB is correct. Ensure gas type parameter is correct. Please call Rinnai Technical Support.
190	Electrical Grounding
	<ul style="list-style-type: none"> Secondary circuit ground fault. Check all electrical components for electrical short.
210	Data Transfer Error
	If the PCB has been replaced, ensure the data transfer process is complete.
220	Gas Valve Adjustment
	<ul style="list-style-type: none"> Ensure a Reed switch is located properly. Ensure the gas valve adjustment is operating correctly.*
250	Condensate Pump (Accessory)
	<ul style="list-style-type: none"> Boiler will operate for 60 seconds. Confirm wire connections and harnesses are good. Ensure the condensate reservoir is empty and condensate pump is operational.
310	Freeze Protection Thermistor
	<ul style="list-style-type: none"> Check sensor wiring for damage. Measure the resistance of the sensor. Replace if necessary.
321	Outgoing Thermistor (Combi Only)
	<ul style="list-style-type: none"> Check sensor wiring for damage. Clean sensor of any scale buildup present. Measure the resistance of the sensor. Replace if necessary.
331	Heat Exchanger Thermistor (Combi Only)
	<ul style="list-style-type: none"> Check sensor wiring for damage. Measure the resistance of the sensor. Replace if necessary.
341	Inlet Thermistor (Combi Only)
	<ul style="list-style-type: none"> Check sensor wiring for damage. Measure the resistance of the sensor. Replace if necessary.
353	Supply Thermistor
	<ul style="list-style-type: none"> Check sensor wiring for damage. Clean the surface of the sensor. Measure the resistance of the sensor. Check the return thermistor. Replace if necessary.

363	Return Thermistor
	<ul style="list-style-type: none"> • Check sensor wiring for damage. • Measure the resistance of the sensor. • Replace if necessary.
371	Indirect Thermistor
	<ul style="list-style-type: none"> • Check sensor wiring for damage. • Check if the indirect thermostat is not used at the setting for thermistor usage. • Measure resistance of sensor. • Replace if necessary.
380	Exhaust Thermistor
	<ul style="list-style-type: none"> • Check sensor wiring for damage. • Clean the surface of the sensor. • Measure the resistance of the sensor. • Check the return thermistor. • Replace if necessary.
393	Outdoor Thermistor
	<ul style="list-style-type: none"> • Ensure that parameter number 00 is set to the appropriate position. • Check sensor wiring for damage. • Measure the resistance of the sensor. • Replace if necessary.
400	Pressure Sensor
	<ul style="list-style-type: none"> • Check sensor wiring for damage. • Measure the voltage of the sensor. • Replace if necessary.
430	High/Low Water Pressure
	<ul style="list-style-type: none"> • If the water pressure is too low, add water into the system until at least 13 PSI is observed. • Ensure there are no leaking components in the CH system. • If the pressure is too high, adjust the pressure to a maximum of 30 PSI. • Ensure the pressure relief valve and water fill are working correctly.
443	Low Water Cut-Off (LWCO)
	<ul style="list-style-type: none"> • Ensure the LWCO device is working correctly. • Ensure the LWCO jumper is connected properly when LWCO is not in use. • Ensure the output is 24 V AC. If it is not, a transformer is needed.

* See “Electrical Diagnostics” on Technical Data Sheet located on inside front cover of boiler.

520	Solenoid Valve Circuit
	<ul style="list-style-type: none"> • Check the flame rod and wire for damage. • Close the gas shut off valve installed near the boiler. • Ensure the flame rod and wire are not wet. • Check the output from the PC Board to the solenoid gas valve. • If the output from the PC Board is abnormal, replace the PC Board. • If the output from the PC Board is normal, replace the gas control.
540	High Exhaust Temperature
	<ul style="list-style-type: none"> • Make sure boiler pump activates during operation. • Check the exhaust thermistor wiring for damage. • Clean the surface of the thermistor. • Measure the resistance of the exhaust thermistor.* • If the sensor has been replaced and the error still appears, check the return thermistor. • If the boiler is used in a hard water area, flush the DHW plate heat exchanger. • Check the exhaust duct, seal, and venting for damage.
610	Combustion Fan
	<ul style="list-style-type: none"> • Check the motor wire harness for loose or damaged connections. • Measure resistance and voltage of motor wire harness.* • Ensure the combustion fan spins freely.
631	DHW Recirculation Pump (Combi Only)
	<ul style="list-style-type: none"> • Ensure the DHW recirculation matches the Parameter 12 setting. • Ensure the dedicated return line is properly installed. • Ensure the inlet water filter and bypass filter are clean and free of debris. • Ensure the DHW recirculation pump is connected to the DHW Pump Terminal. • Ensure the capacity of the recirculation pump is sized appropriately for the piping (DHW recirculation pump should be higher than 1.3 GPM). • Ensure air is removed from the recirculation line.

651	Water Flow Control (Combi Only)
	<ul style="list-style-type: none"> • Measure the resistance values and voltage of the water flow control.* • Ensure the harness and connector are not wet. • If the voltage from the PC Board is abnormal, replace the PC Board; otherwise, replace the water flow servo valve.
661	By-Pass (Combi Only)
	<ul style="list-style-type: none"> • Measure the resistance values and voltage of the bypass servo valve.* • Ensure the harness and connector are not wet. • If the voltage from the PC Board is abnormal, replace the PC Board; otherwise, replace the bypass servo valve.
670	3-Way Valves (Combi Only)
	<ul style="list-style-type: none"> • Check the CH system water quality. • Measure the resistance values and voltage of the 3-way valve control.* • Replace the 3-way valve control device.
681	Hot Water Supply Temperature Abnormality (Combi Only)
	<ul style="list-style-type: none"> • If the DHW water temperature is higher than the set point temperature because the boiler bypass servo fails to close. • Measure resistance values and voltage of the bypass flow control.* • Replace the bypass flow control device if needed; otherwise, check the inlet thermistor and heat exchanger thermistor wiring for damage. • Measure the resistance of the sensor. Replace if needed. • Clean the sensor of any scale buildup present.
700	PC Board
	<ul style="list-style-type: none"> • PC Board circuit error. • Replace PC Board.
710	Solenoid Valve Circuit
	<ul style="list-style-type: none"> • Ensure Dip switch 5 on the PC Board is in the OFF position (default). • Ensure the gas control wire is not loose or damaged. • Ensure the heater circuit is not grounded. • Ensure the outgoing thermistor works without error by using DHW (Combi Only). • Replace the PC Board.

720	Flame Rod
	<ul style="list-style-type: none"> • Check the flame rod and wire for damage. • Ensure the flame rod and wire are not wet. • If there is no issue with the flame rod or wiring, replace the PC Board.
831	Indirect Tank Temperature
	<ul style="list-style-type: none"> • Indirect tank runs for more than twelve hours without cycling off. • Check if the tank size is adequate. • Check the thermistor location. • Confirm that primary-secondary piping is utilized (such as low loss header, closely spaced tees, etc.) • Check if the supply temperature for the tank is higher than the tank setting temperature (see parameter 30 in "Parameter Settings" section). • Check sensor wiring for damage. • Measure resistance of sensor.* • If something is wrong on the sensor, replace the sensor.
890	Freeze Issue
	<ul style="list-style-type: none"> • The boiler checks the heat exchanger temperature at the time of operation. If the temperature is too low, an error will occur. • Check if there is freezing in the boiler or CH system.
LC	Scale Buildup in Heat Exchanger (Combi Only)
	<ul style="list-style-type: none"> • Flush the DHW plate heat exchanger. • The LC code will reset automatically when scaling is removed. • If the LC code remains, check the DHW thermistor, flow sensor or boiler pump.
FFF	Maintenance Indicator
	<ul style="list-style-type: none"> • This code is a placeholder in diagnostic code history indicating a service provider performed maintenance or service. • Enter this code after performing service by pressing the following buttons at the same time: UP, DOWN, and DHW. FFF appears on the monitor.
55	Service Soon
	<ul style="list-style-type: none"> • Service Soon (55) is a time-based service indicator set during installation. See parameter 04 in section "12.4 Parameter Settings" for more information. • To reset 55 code, press Central Heating button 5 times until 55 disappears.

* See "Electrical Diagnostics" on Technical Data Sheet located on inside front cover of boiler.

NO CODE	Decreasing or Fluctuating DHW Water Flow Volume (Combi Only)
	<ul style="list-style-type: none"> • Ensure the gas pressure is proper. • Ensure the water pressure is proper. • Ensure the inlet water filter for DHW is clean. • Ensure there is not lime scale buildup present. • Ensure the vent and vent settings are properly set up. • If a DHW recirculation system is used, the DHW flow volume may vary slightly. • Ensure all air has been purged from the system.
NO CODE	Fluctuating DHW Outgoing Temperature (Combi Only)
	<ul style="list-style-type: none"> • Ensure the gas pressure is proper. • Ensure the water pressure is proper. • Ensure the DHW thermistor, flow servo, and bypass servo are in good condition. • Ensure the inlet filter for DHW is clean. • If a DHW recirculation system is used, the DHW temperature may vary slightly. • Ensure all air is removed from the system.
NO CODE	Boiler Does Not Start Heating With a Heating Demand Present
	<ul style="list-style-type: none"> • Supply temperature or return temperature inside the boiler may be too hot. • Ensure the pump operates properly. • If there is a demand immediately after using DHW, wait at least three minutes for operation.
NO CODE	Cannot Turn off ECO Mode
	<ul style="list-style-type: none"> • During DHW recirculation, ECO switch will always be on (Combi only).
NO CODE	Cannot Set Up Lock
	<ul style="list-style-type: none"> • Lock is available only when the controller has the priority. (When connecting additional remote controller) (Combi only).

* See “Electrical Diagnostics” on Technical Data Sheet located on inside front cover of boiler.

NO CODE	DHW Recirculation Does Not Begin (Combi Only)
	<ul style="list-style-type: none"> • Ensure the DHW recirculation pump is connected to the DHW_Pump terminal. • Ensure parameter number 09 is ON. • Ensure the DHW recirculation plumbing type is set properly per Parameter 12. • Ensure the DHW recirculation with timer relay input is set properly per Parameter 13. • Ensure the wiring to the external timer is correct. • Ensure the external timer is ON, if in use. • The recirculation logic has an OFF interval after use.
NO CODE	Simultaneous DHW and CH is Not Functional (Combi Only)
	<ul style="list-style-type: none"> • Ensure parameter number 08 is ON. • If CH set point temperature is lower than 140°F/60°C, it is not permitted (this includes outdoor reset temperature settings). • Ensure the DHW inlet temperature is not too hot. • Ensure the heating load for DHW and CH are within limits to handle both simultaneously.
NO CODE	Cannot Change the DHW Set Point Temperature (Combi Only)
	<ul style="list-style-type: none"> • When DHW is being produced, the temperature setting can only be adjusted between 98°F (37°C) and 110°F (43°C).
NO CODE	Supply Temperature is Different From the Setting Temperature on the Controller
	<ul style="list-style-type: none"> • During outdoor sensor control, the supply temperature will vary dependent on the outdoor temperature. • During simultaneous operation of DHW and CH, the supply temperature for CH is based on DHW control (Combi Only).
NO CODE	CH Capacity is Insufficient
	<ul style="list-style-type: none"> • Ensure the parameters are properly set for the installation. • During simultaneous operation of DHW and CH, flow volume to heating can be reduced (Combi Only).
NO CODE	Pump or Fan Even With No Demand
	<ul style="list-style-type: none"> • The boiler may start or operate the pump for freeze protection operation. • The pump may intermittently operate to prevent it from becoming stuck.

12.9 Forced Hi/Low Fire Modes



WARNING

This section should be performed by a licensed professional. Consumers should never attempt any action that they are not qualified to perform.

1. Remove the boiler's front panel by removing the two screws that secure the panel.
2. Locate the PC Board (lower left side of unit).
3. Press and hold the SW3, right-side, black button.

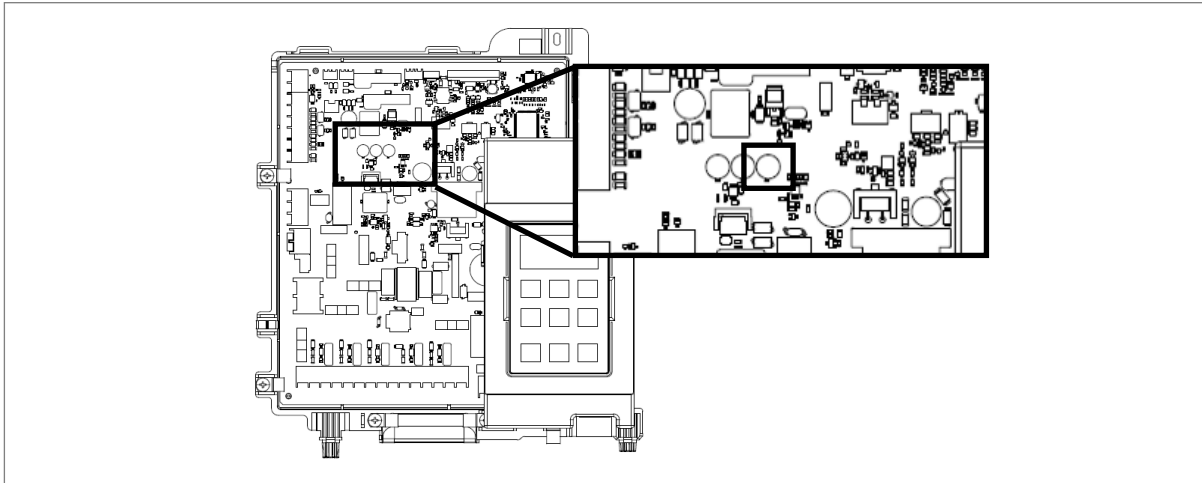

Figure 116

4. Press the up and down arrows to select FOC (forced combustion mode.)
5. Press the Select button to enter the forced combustion mode.
6. Press the up and down arrows to select FL (forced low combustion).
7. Press the Select button to enter FL (force low combustion).
8. To finish FL (forced low combustion), press the Setting menu button.
9. Press the up and down arrows to select FH (forced high combustion).
10. Repeat step 6, 7 and 8 for FH (forced high combustion).

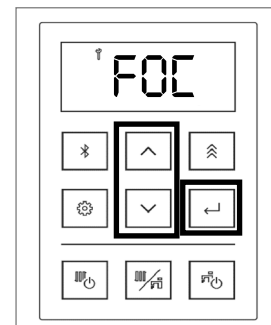

Figure 117

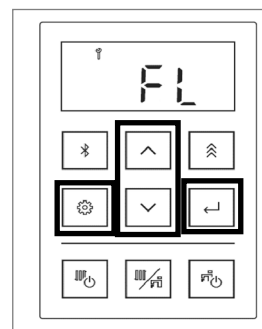

Figure 118 (A)

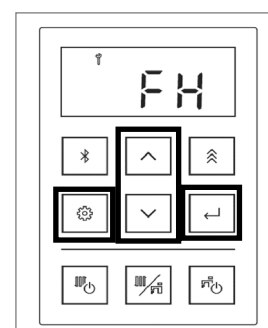

Figure 118 (B)

11. To enter back into normal operation, press the SW3 right-side, black button. The controller now displays normal operation mode.

13. Maintenance

Topics in this section

- Owner Maintenance
- Licensed Professional Maintenance
- Test the Ignition Safety Shutoff Device

WARNING

- Maintenance is required to maintain safe operation of the boiler.
- The boiler is recommended to be inspected annually by a licensed professional. Repairs and maintenance shall be performed by a licensed professional. The licensed professional is recommended to verify proper operation after servicing.
- Keep the boiler area clear and free from combustible materials, gasoline, and other flammable vapors and liquids.
- To protect yourself from harm, before performing maintenance:
 - Turn off the electrical power supply by unplugging the power cord or by turning off the electricity at the circuit breaker. (The boiler controller does not control the electrical power.)
 - Turn off the gas at the manual gas control valve, usually located immediately below the boiler.
 - Turn off the incoming water supply. This can be done at the isolation valve immediately below the boiler or by turning off the water supply to the building.

13.1 Owner Maintenance

WARNING

If you encounter a problem that is difficult to solve, stop the operation and immediately contact a licensed professional.

Table 45

MONTHLY	
Boiler Area	<ul style="list-style-type: none"> • Verify the area is free of combustible materials, gasoline and other flammable vapors and liquids. • Verify the area is clean from dust and obstructions. • Verify the air intake area is free of any contaminants listed in the boiler Installation and Operation Manual. Any contaminants in the boiler intake air vicinity must be removed. If they cannot be removed, contact a licensed professional.
Piping	<ul style="list-style-type: none"> • Inspect all water, gas, and condensation piping for leaks. Look for signs of leaking lines or corrosion. • Confirm the condensation line is not blocked. If a condensation drain pump is used, confirm the condensation drain pump operates correctly.
Venting	<ul style="list-style-type: none"> • Verify the boiler vent discharge and air intake is clean and free of obstructions. • Check for leakage, damage, or deformation of venting.
Boiler	<ul style="list-style-type: none"> • Verify the boiler is free from any abnormal situations, such as diagnostic error codes, loud noises, leakage or other potential issues. • Check that the pressure on the controller display or external pressure gauge indicates 17 to 26 PSI (117 to 180 kPa).

13.2 Licensed Professional Maintenance

Table 46

ANNUALLY	
Vent System	<ul style="list-style-type: none"> Inspect for blockages or damage. Inspect vent screen or room air filter (if using) for debris and blockages. Clean if needed.
Fan and Motors	Clean dust and dirt from fan and motor (motors are permanently lubricated and do not require lubrication).
Controller	Clean by using a soft, damp cloth. Do not use solvents.
Pressure	Confirm the pressure is within the proper range (between 17-26 PSI). If the pressure is lower than the specified range, add water until in the proper range.
Pressure Relief Valve	<p>Operate the pressure relief valve manually once a year. In doing so, it will be necessary to take precautions with regard to the discharge of potentially scalding hot water under pressure. Ensure discharge has a safe place to flow. Contact with your body or other property may cause damage or harm.</p> <div style="border: 1px solid black; padding: 5px; margin-top: 10px;"> <p> WARNING Testing the pressure relief valve should only be performed by a licensed professional. Water discharged from the pressure relief valve could cause severe burns instantly or death from scalds.</p> </div>
Heating System Dirt Trap	Clean annually. Be sure to close the shut off valves under the boiler. After cleaning and installing the filter, purge the air.
Expansion Tank	Perform annual checks as recommended by the manufacturer to ensure proper operation.
Condensation Trap	Check if the trap contains sediment. To remove sediment, unplug the bottom of the condensate trap. Remove the sediment, and then return the plug. Do not use a wrench to tighten the condensate drain as this could cause the connection to break.
Condensation Drain	<ul style="list-style-type: none"> Confirm the condensation drain line is not blocked or clogged. Ensure the condensation drain pump (if utilized) is working correctly.
Draining Water	When the system will be shutdown for a long period of time (seasonal shutdown), close the shutoff valves below the boiler and drain the boiler to protect it from potential freeze damage.

Pump Lock	Confirm the pump operates smoothly. The boiler operates pump lock operation at least in 48 hours for all of system pumps. If it is pump locked, rotate the cap in front of pump by flat driver.
Water Quality	Confirm the water quality. Refer to section “4.4.1 Water Quality Guidelines” to determine if the water needs to be treated or conditioned. DHW must be potable, free of corrosive chemicals, sand, dirt, or other contaminates. It is up to the installer to ensure the water does not contain corrosive chemicals or elements that can affect or damage the heat exchanger. Water that contains chemicals exceeding the levels required affect and damage the heat exchanger. Replacement of the heat exchanger due to water quality damage is not covered by the warranty.
Snow Accumulation	<ul style="list-style-type: none"> • Verify the area around the flue terminal is free of snow and ice. The boiler will not function properly if the combustion air or exhaust vent pipes are impeded (blocked or partially blocked) by obstructions. • Verify the condensate drain line is free of snow and ice. Ensure the line is not blocked or clogged and that condensate is flowing freely.
Freeze Protection	<ul style="list-style-type: none"> • Freeze protection for new or existing systems must use glycol that is specially formulated for this purpose. This includes inhibitors, which prevent the glycol from attacking the metallic components. The glycol should be for multi-metallic components. Reference section “14.1 Approved Cleaners, Inhibitors and Antifreezes” in the Appendix for an approved list of system cleaners, inhibitors, and antifreezes. • Check that the system fluid is correct for the glycol concentration and inhibitor level. The system should be tested at least once a year and as recommended by the producer of the glycol solution. The allowed maximum concentration is 40 percent.
Coast Area Installations	Installations located in or near coastal areas may require additional maintenance due to corrosive airborne ocean salt. If corrosion is observed on the body of the boiler, the boiler shall be inspected to ensure proper operation and repaired or replaced, if necessary.
Cleaning	<p>It is imperative that control compartments, burners, and circulating air passageways of the boiler be kept clean. Check burner flame for proper color. Once ignited, the flame must cover the surface of the burner. The flame must burn with a clear, blue, stable flame. If the flame does not have this appearance, complete the following steps:</p> <ul style="list-style-type: none"> • Turn off and disconnect electrical power. Allow to cool. • Remove the front panel. • Use a vacuum to remove dust from the main burner and fan blades. Do not use a wet cloth or spray cleaners on the burner. Do not use volatile substances such as benzene and thinners; they may ignite or fade the paint. • Do not open the burner cabinet and touch the burner surface. <p>Condensate Trap Cleaning:</p> <ul style="list-style-type: none"> • Inspect the condensate drain assembly inside the boiler and your external drain system. • Remove any debris that may be present in the condensate removal system.

<p>Intake Filter</p>	<p>Inspection:</p> <ul style="list-style-type: none"> • To maintain optimum performance, periodically inspect the air filter. • If the air filter appears to have lint and/or dust build up, follow the cleaning procedure described below. • If the air filter appears damaged, contact a trained and qualified professional for a replacement air filter assembly. <p>Cleaning:</p> <ul style="list-style-type: none"> • Clean the Air Filter: With mild dish soap and a soft bristle brush, scrub the filter area of the air filter door. With clean water, rinse the soap off the filter. • Dry the Air Filter: With a lint free towel, dry the air filter.
-----------------------------	--

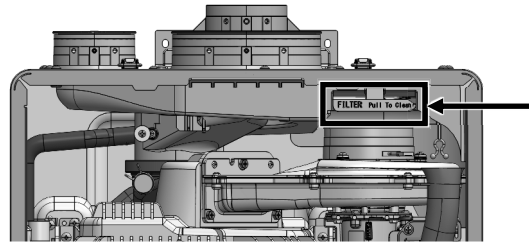

Figure 119

AFTER SERVICING: VISUAL INSPECTION OF FLAME

Verify proper operation after servicing. The burner must flame evenly over the entire surface when operating correctly. The flame must burn with a clear, blue, stable flame. See the parts breakdown of the burner for the location of the view ports. The flame pattern should be as shown in the images below:

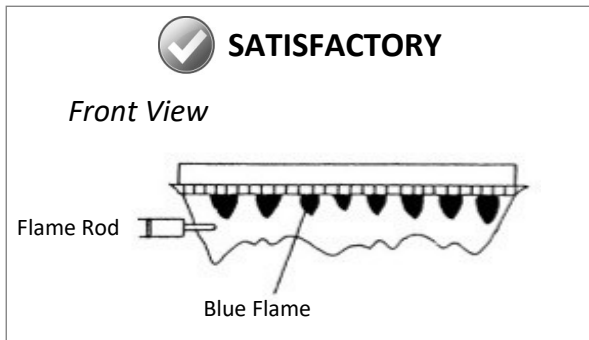

Figure 120

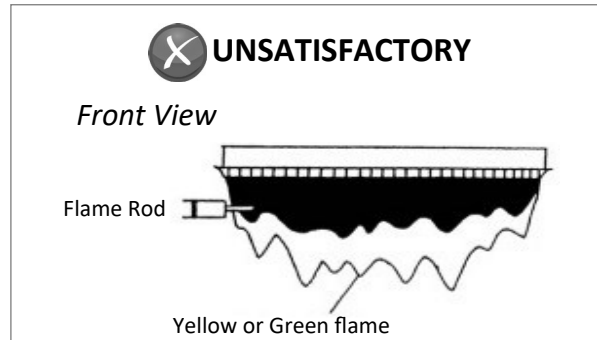

Figure 121

Freeze Protection Operation

When the boiler detects low outdoor ambient temperatures, the boiler will begin its freeze protection operation. The freeze protection operation can protect the boiler from freezing down to as low as -22°F (-30°C) outdoor temperature.

When freeze protection is in operation, the pump may circulate water and/or the boiler may operate to prevent the boiler from freezing.

Ensure power and gas are supplied to the boiler for freeze protection to function. The internal freeze protection will not necessarily prevent the system piping from freezing. During freeze protection operation, the pressure and supply temperature will alternately display on the controller.

The icon for CH and DHW may alternate depending on the operation of the freeze protection sequence.

When the system needs to be shutdown for extended periods of time, the boiler and all system piping should be drained. The power and gas supply should then be disconnected from the boiler. Freezing damage may occur if there is water remaining in the boiler or system piping. The plumbing lines should also be blown out via compressed air.

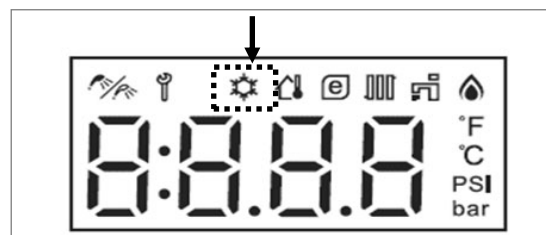

Figure 122

13.3 Test the Ignition Safety Shutoff Device

1. Ensure the boiler is not currently firing and the flame rod is not hot.
2. Remove the boiler front panel.
3. Disconnect the wiring connection from the left side flame rod (located on front of the boiler under the burner).

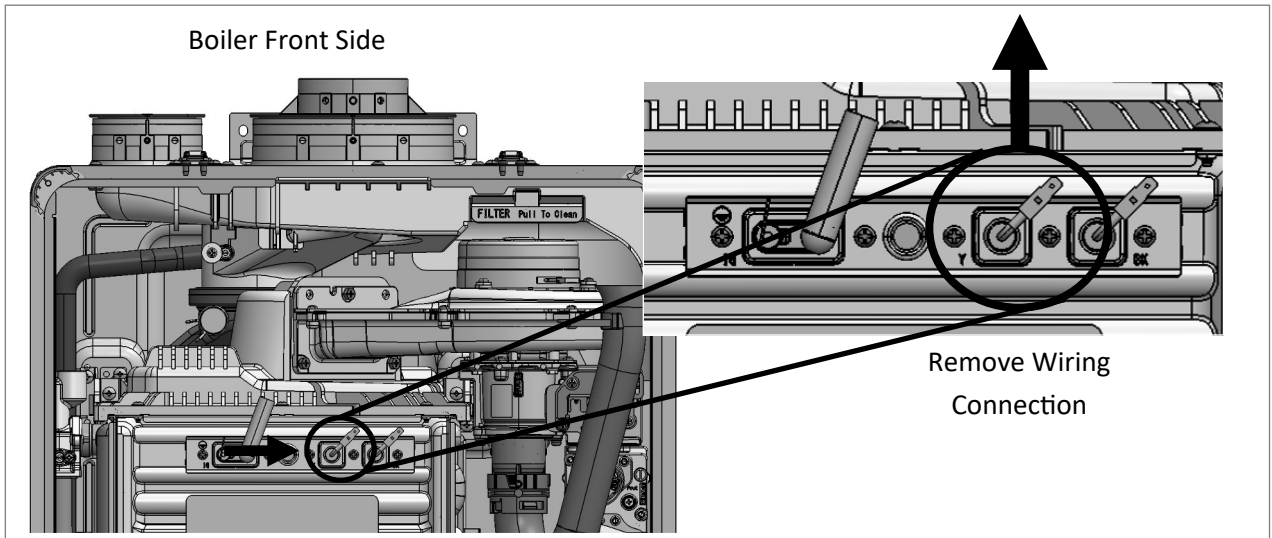

Figure 123

WARNING Do not touch the inside of the wiring connection while it is disconnected.

4. Place the boiler in operation by either a call for heat or by turning on a Domestic Hot Water fixture.
5. The boiler initiates one start-up attempt and multiple restart attempts.
After the last start-up attempt, the boiler locks out and the gas valve shuts off. Code **!!!** appears on the controller display which indicates ignition system safety shutoff.
6. Reconnect the wiring connection to the flame rod. Be careful not to touch the inside of the wiring connection. To reset the error, press the **Central Heating** button. The boiler starts up.

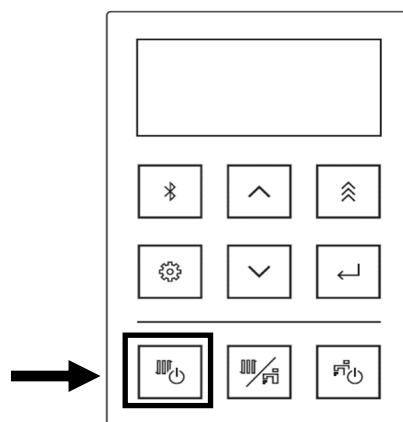

Figure 124

7. Replace the boiler front panel.
8. The boiler may now go back into normal operation.

14. Appendices

Topics in this section

- Approved Cleaners, Inhibitors and Antifreezes
- Flush the CH Plumbing System
- System Application Examples
- Gas Conversion
- Wiring Diagram
- Ladder Diagram
- CH Pressure Drop and Flow Curve
- Remove a Boiler from a Common Vent System
- Massachusetts State Gas Regulations
- Warranty

14.1 Approved Cleaners, Inhibitors and Antifreezes

Below is a list of approved system cleaners, inhibitors, and antifreezes for use in hydronic plumbing systems utilizing Rinnai boilers.

Approved System Cleaners:

- Fernox F3 Cleaner
- Noble Noburst Hydronic System Cleaner
- Rhomar Hydro-Solv 9100
- Sentinel X400

Approved System Inhibitors:

- Fernox F1
- Noble Noburst AL Inhibitor
- Rhomar Pro-tek 922
- Sentinel X100

Approved System Antifreezes:

- Chem Frost 100%
- Cryo-Tek 100
- Fernox Alphi 11
- Hall-Chem Solar II
- NemFrost-PG HTF
- Rechochem Recofreeze AL
- Rhomar RhoGard Mutli-Metal (AL safe)
- Sentinel X500
- Univar Vanfrost



IMPORTANT

- If replacing a boiler, add system cleaners while the old boiler is installed and operate the old boiler for heating for several days to most effectively clean the system.
- The Rinnai boiler must be closed off (valved off) from the rest of the system, or not connected, while cleaners are in the system.
- When cleaning is complete, drain the system and then flush with clean water to remove any sediment.

14.2 Flush the CH Plumbing System

Note: This section explains how to flush the CH plumbing system.

When replacing an existing boiler, the heating system shall be flushed with an approved system cleaner before the new boiler is added to the system.

Manual Flush Procedure:

Note: Reference section “14.1 Approved Cleaners, Inhibitors and Antifreezes” in the Appendix for an approved list of system cleaners, inhibitors, and antifreezes.

1. Disconnect the power supply to the boiler and turn off gas.
2. Add an approved cleaner to the system following the manufacturer’s directions. Allow the boiler to run for 3 days in DHW and/or heating operation.
3. Flush the boiler and the system, and clean the dirt trap if present.
4. Purge the boiler and the system as described below. Add an approved inhibitor (recommended). Run the boiler in its deaeration program per the instructions in section “10.3 Deaeration Process.”

Boiler Flush or Purge Procedure:

- **System:** Close supply shutoff #3 and boiler valves #1 and #2. Open autofill to at least 20 PSI, then flush or purge through Hose #2 by opening boiler drain #4.
- **Boiler:** Keep valves #1 and #3 closed. Open #2 and close #4. With the autofill open to at least 20 PSI, flush or purge the boiler through Hose #1.

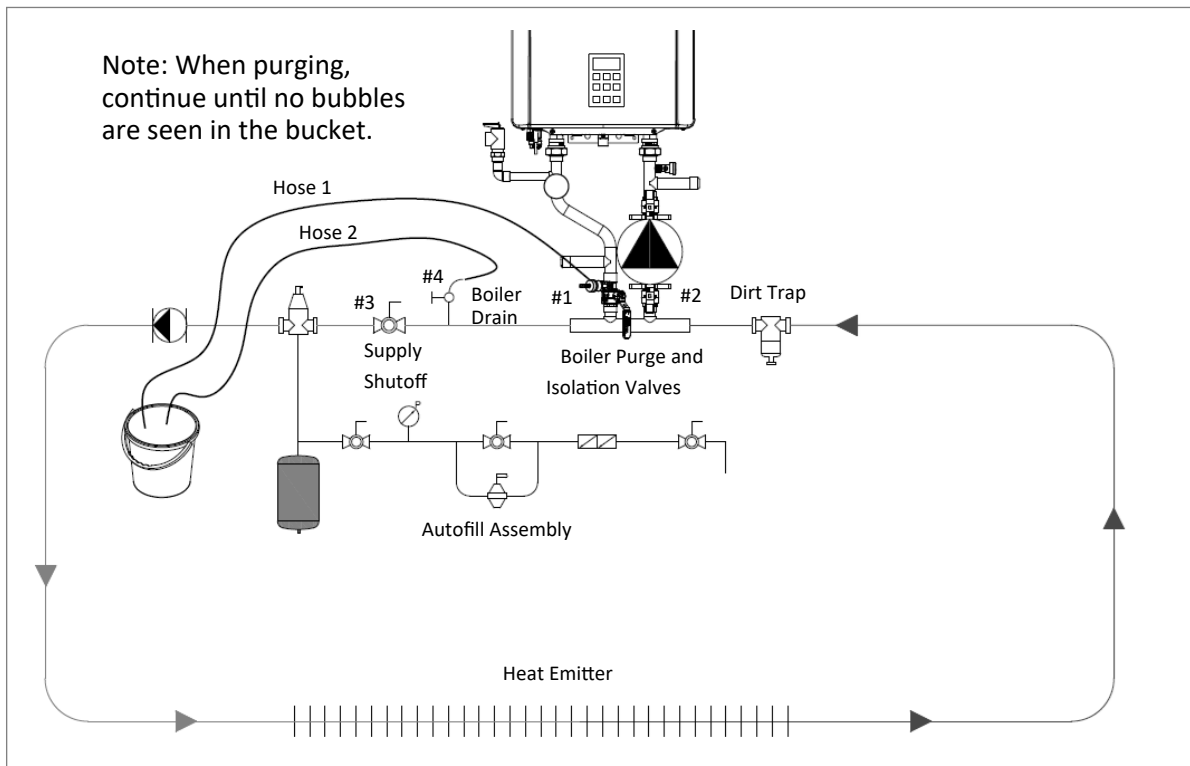
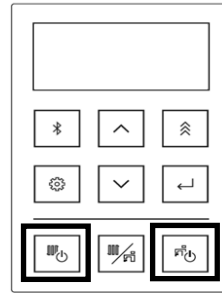

Figure 125

Boiler Automated Flush Procedure:

1. Shut off gas supply and turn off DHW and CH buttons on the controller.

Figure 126



2. Remove the boiler front panel by removing the two screws that secure the panel.
3. Locate the PC Board (lower left side of unit).
4. Press the SW3 button on the PC Board (Figure 127).

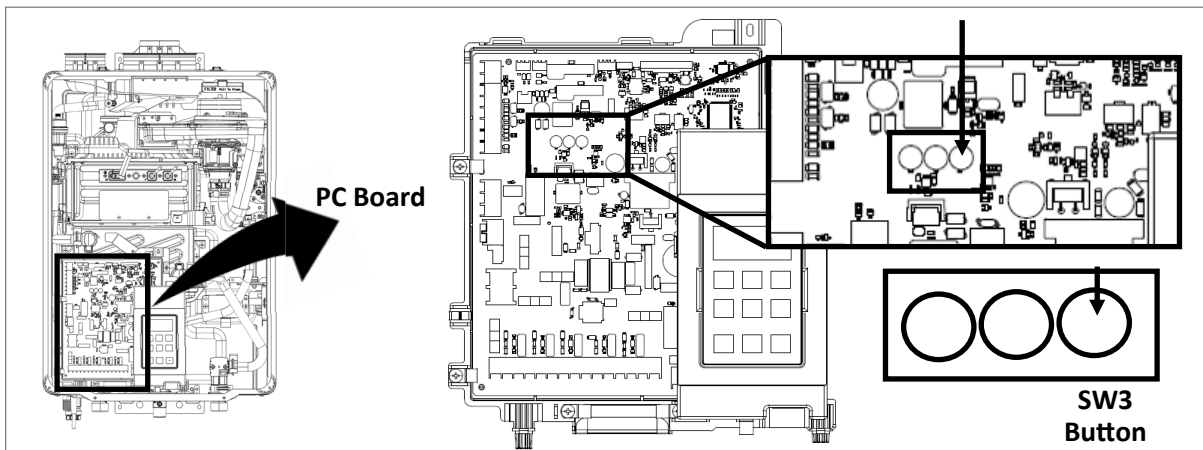

Figure 127

5. Press the up or down arrow button on the controller to select dES (descaling) (Figure 128).
6. Press the Select button to select the dES (Figure 128).

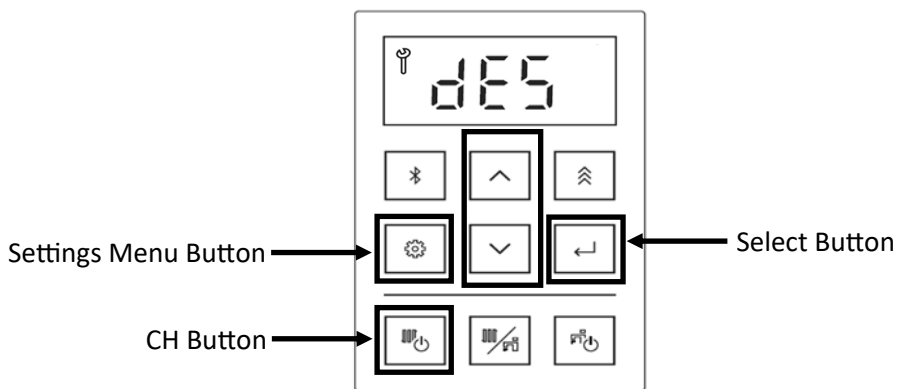

Figure 128

7. Make sure the valves and hoses are set up as shown in the previous page. Next, operate the pump and allow the cleaner to circulate through the boiler for at least 1 hour at a rate of four gallons per minute (15.1 liters per minute).
8. Press the Central Heating (CH) button to start the count down (Figure 128).
9. Display shows "60" (Figure 129) which indicates the remaining flush time in minutes. The number decreases by 1 every minute.

Note: If you need to cancel this procedure, you may press the Settings Menu button on the controller (Figure 128), or press the SW3 button on the PC Board (Figure 127).



Figure 129

10. After 60 minutes flushing time completes, display shows “rnS” (rinsing) (Figure 130) and beeping sound is observed.

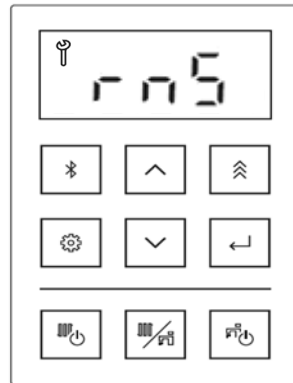

Figure 130

11. Turn off the pump.
- 12(A). Rinse cleaner from **system**:
- Remove the free end of the drain hose (H2) from the pail. Place in sink or outside to drain. Open autofill to at least 20 PSI.
 - Close boiler valves 1 and 2. Close shutoff valve (V3).
 - Open drain valve 4.
 - Allow water to flow through the boiler for five minutes.
 - Close drain valve (V4).
 - Open shutoff valve (V3), boiler valve 1 and 2.
- 12(B). Rinse cleaner from **boiler**:
- Remove the free end of the drain hose (H1) from the pail. Place in sink or outside to drain. Open autofill to at least 20 PSI.
 - Close drain valve (V4).
 - Open boiler valves 1 and 2. Close shutoff valve (V3).
 - Allow water to flow through the boiler for five minutes.
 - Open shutoff valve (V3).
13. Push the Select button, and the display shows “End” (Figure 131).

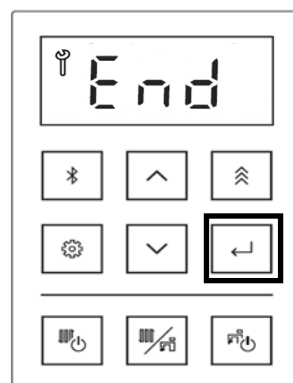

Figure 131

14. Disconnect all hoses.
15. Push the Select button to go back to "dES" and press the SW 3 on the PC board to put the unit back to normal mode.
16. Install the front panel and restore gas supply.

IMPORTANT

Scale build-up will affect the performance of the boiler. Water should be treated. Rinnai offers Southeastern Filtration's "Scale Cutter Water Conditioning System" that offers superior lime scale prevention and corrosion control by feeding a blend of control compounds into the cold water supply.

14.3 System Application Examples

IMPORTANT

Primary/secondary piping is necessary in the following applications:

- When using external pumps
- Large zoned systems
- High flow applications
- Systems with high differential pressures
- Systems with high pressure drops

For pressure curve information, refer to the following sections in the Appendix.

- 14.7 CH Pressure Drop and Flow Curve

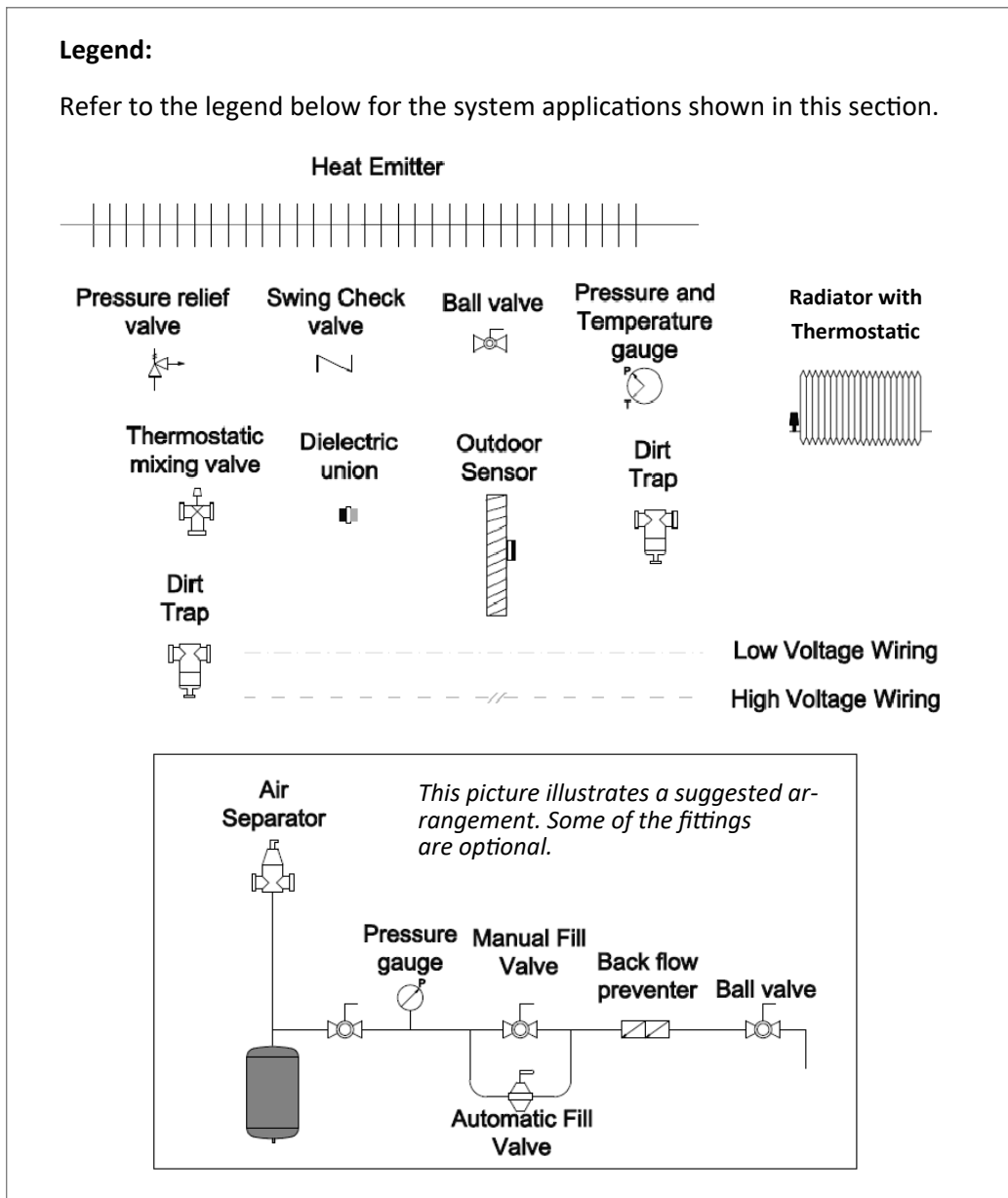

Figure 132

14.3.1 Single Zone Pump Control with Hydraulic Separation Plumbing

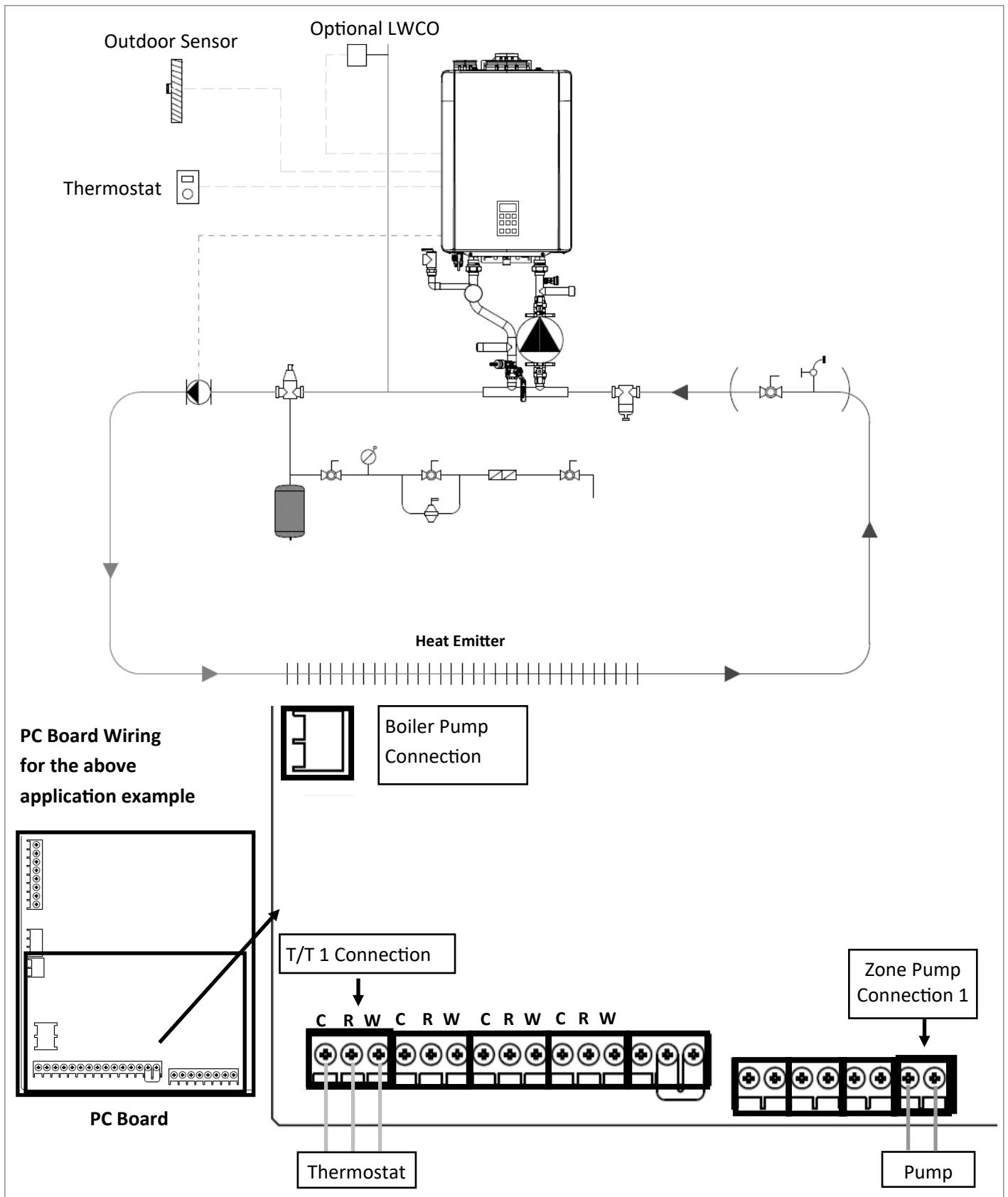

Figure 133

14.3.2 Four Zone Valve Control with Hydraulic Separation Plumbing (Option 1)

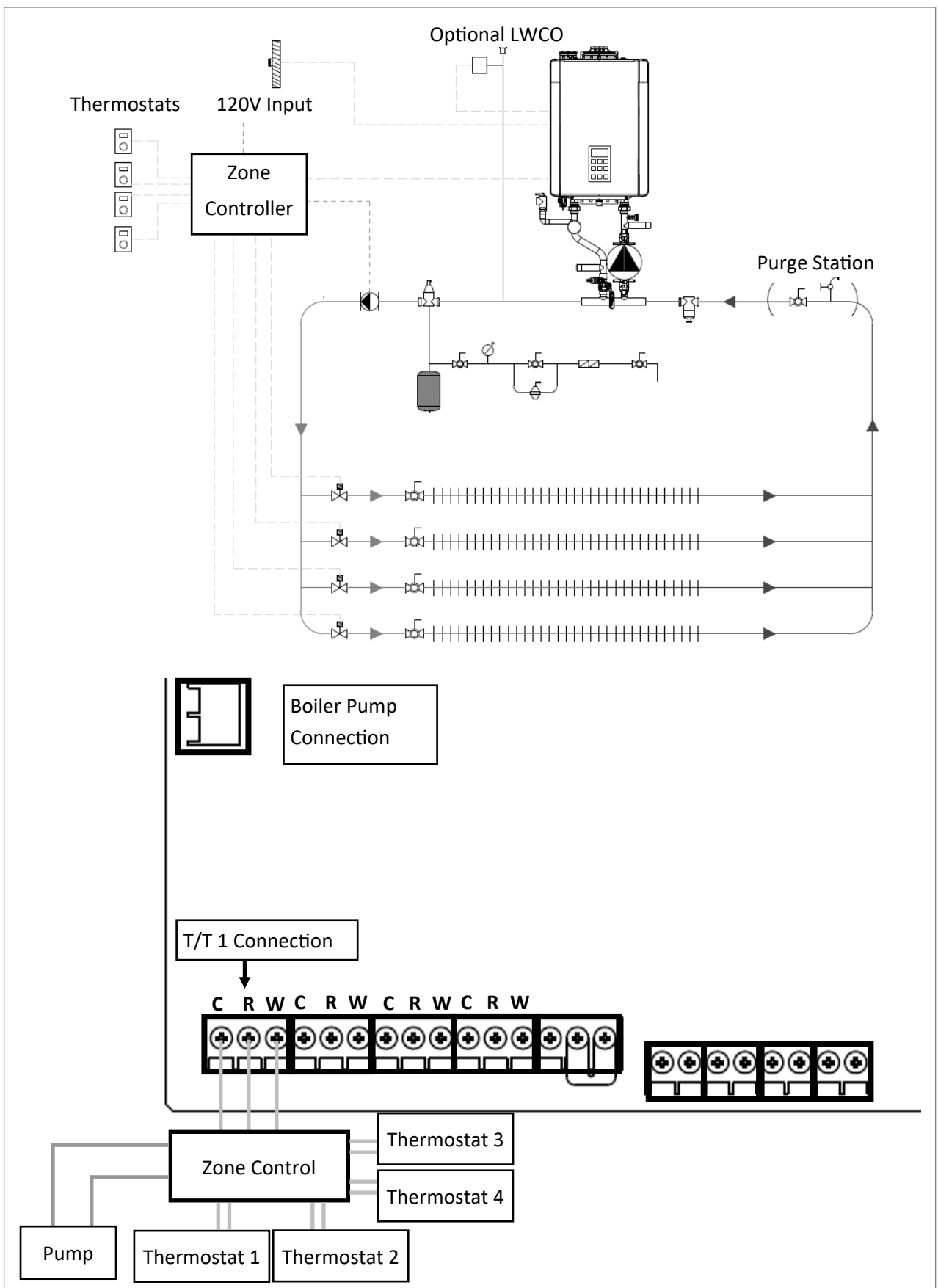

Figure 134

14.3.3 Four Zone Pump Control with Hydraulic Separation Plumbing (Option 2)

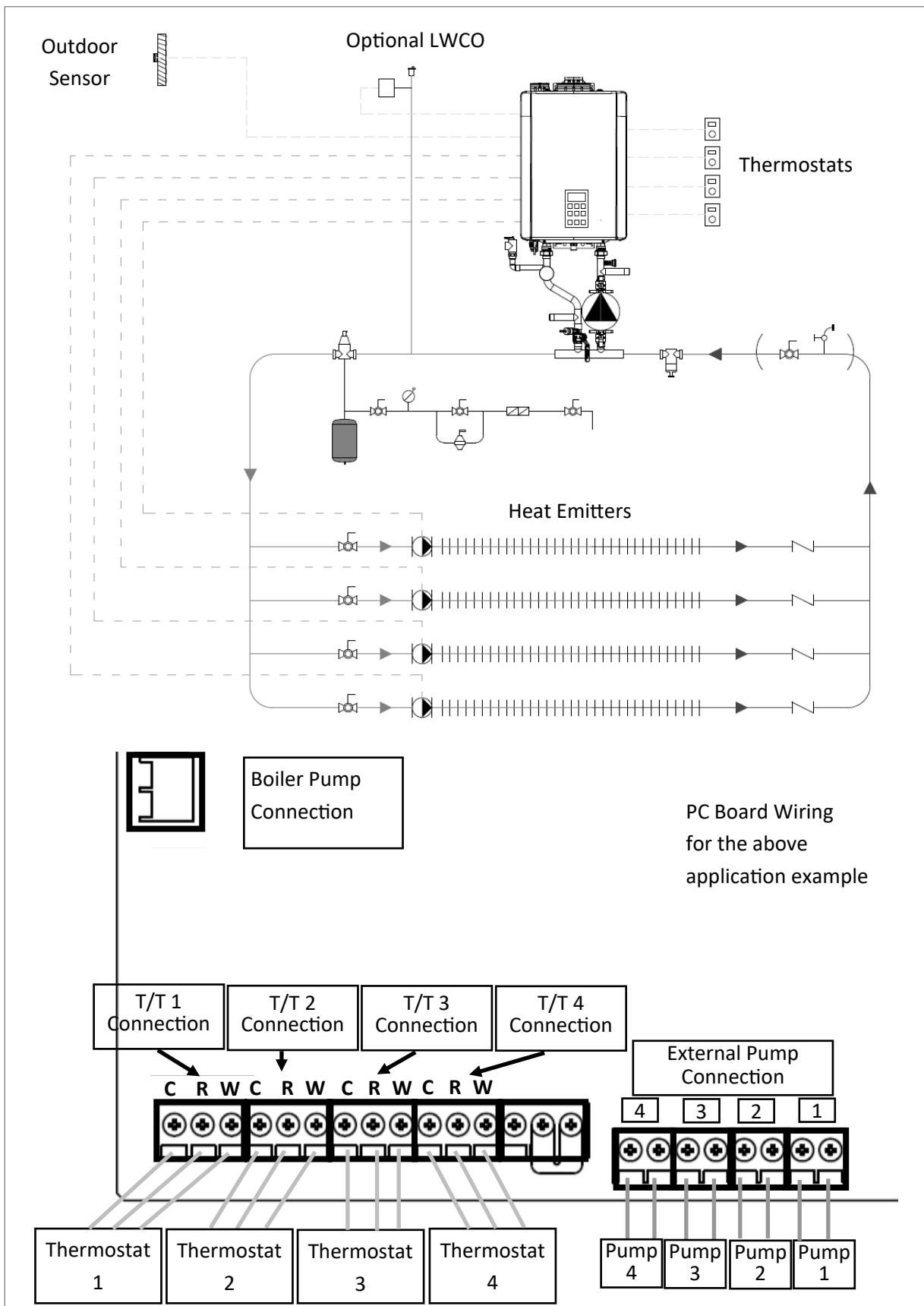

Figure 135

14.4 Gas Conversion

This boiler is configured for Natural Gas only. To convert to Propane Gas, follow the instructions in this section.

WARNING

- The conversion kit shall be installed by a qualified service agency in accordance with the manufacturer's instructions and all applicable codes and requirements of the authority having jurisdiction. The information in these instructions must be followed exactly to minimize the risk of fire or explosion or to prevent property damage, personal injury or death. The qualified service agency is responsible for the proper installation of this kit. The installation is not proper and complete until the operation of the converted appliance is checked as specified in the manufacturer's instructions supplied with the kit.
- Failure to correctly assemble the components according to these instructions may result in a gas leak or explosion.

For installations in Canada, the conversion shall be carried out in accordance with the requirements of the provincial authorities having jurisdiction and in accordance with the requirements of the CGA-B149.1, Natural Gas and Propane Installation Code.

The appliance must be installed in accordance with:

- Local codes or, in the absence of local codes, the National Fuel Gas Code, ANSI Z223.1/NFPA 54 and/or CSA B149.1, Natural Gas and Propane Installation Code.
- The Manufactured Home Construction and Safety Standard, Title 24 CFR, Part 3280 and/or CAN/CSA Z240 MH Series, Mobile Homes, Series M86 / *Manufactured Home Construction and Safety Standard, Title 24 CFR*.

CAUTION

The gas supply shall be shut off prior to disconnecting the electrical power, before proceeding with the conversion.

CAUTION

Do not touch any other areas on the PC board other than the described buttons while power is supplied to the appliance. Parts of the PC board are supplied with 120 volts AC.

CAUTION

Do not touch the areas at or near the heat exchanger or hot water lines. These areas become very hot and could cause burns.

IMPORTANT

- Before you get started, confirm that the inlet gas pressure is between the minimum and maximum pressures allowed for this boiler.
- If subsequent conversions are made, then a new conversion label must be placed on the boiler to accurately reflect the gas type.

14.4.1 Item Required

- Conversion Rating Plate

14.4.2 Adjust Parameter Setting

1. Locate the PC Board (lower left side of unit).
2. Locate the left PC Board button.
3. Press and hold the button for five seconds (Figure 136). 00-A appears (Figure 137).

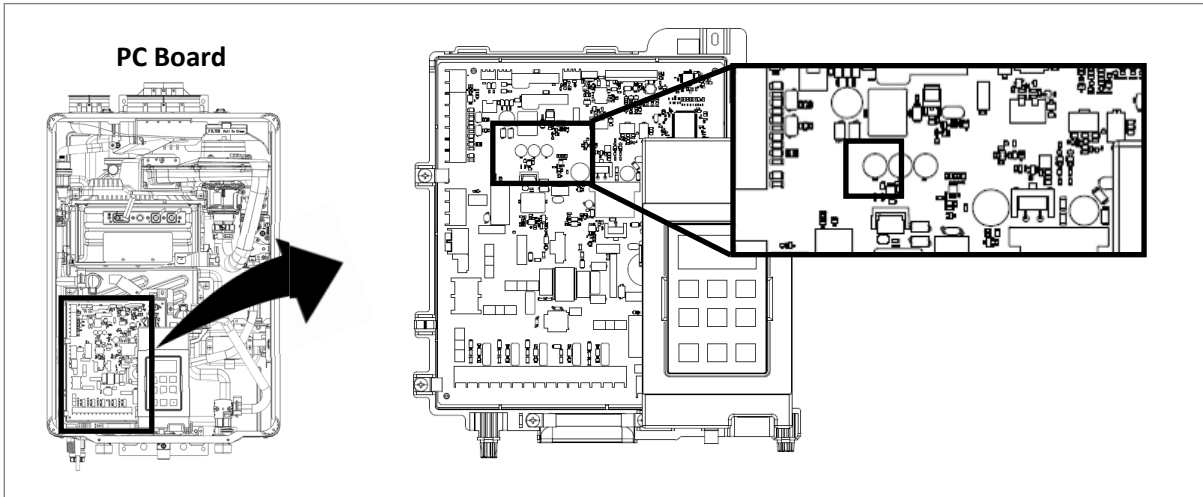

Figure 136

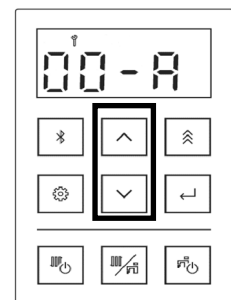

Figure 137

4. Scroll to parameter R0 and press the **Select** button.

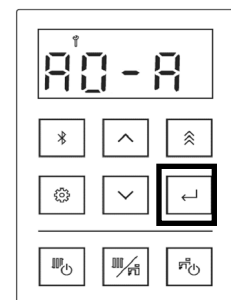

Figure 138

5. Press the ▲ (Up) or ▼ (Down) arrows to select the appropriate gas type.
 - Select **R** for Natural Gas (NG)
 - Select **b** for Propane (LP)

Then, press the **Select** button.

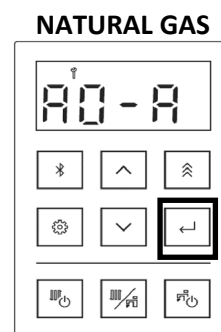

Figure 139

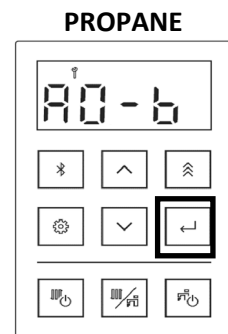

Figure 140

6. Parameter settings are complete. To enter normal operation mode, press the left PC Board button.

14.4.3 Check Operation

1. Check the normal operating sequence:
 - a. When you press the ON/OFF button, the LED display will illuminate, the combustion fan will begin to run if water is flowing, and the spark will ignite the main burner.
 - b. This boiler has an automatic ignition system. When the main burner has lit, the “In Use” lamp will glow red and the spark will stop.
2. Visual inspection of flame:
 - a. Check that the burner flames are operating normally. The flame can be seen through the circular window above the burner. When operating normally, the burner flame should burn evenly over the entire surface. The flame should be clear, blue, and stable. A yellow flame is abnormal and maintenance is required.

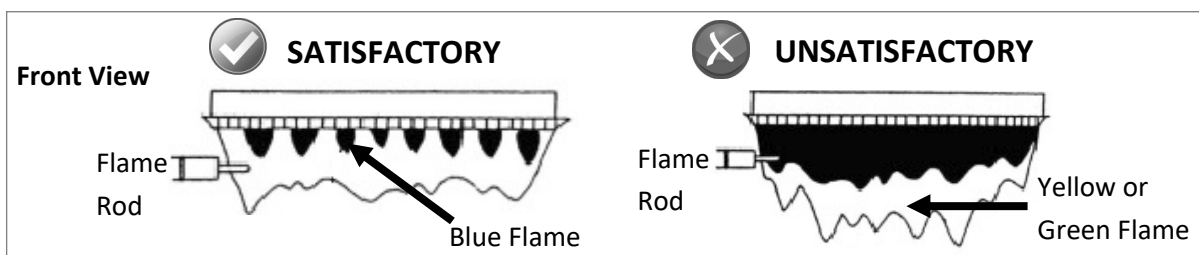

Figure 141

3. Reinstall the boiler front panel using the two screws to secure it.

14.4.4 Perform Combustion Analysis



WARNING

Combustion analysis must be performed by a trained and qualified professional.

To perform a combustion analysis:

1. Remove the boiler's front panel by removing the two screws that secure the panel.
2. Remove the clamp holding the combustion analysis port cap.
3. Remove the combustion analysis port cap and insert the gas analyzer probe into the port.
4. Put the boiler into operation in forced high fire or low fire as necessary (see section “12.9 Forced Hi/Low Fire Modes”). Measure CO₂ or O₂, as applicable, in the exhaust system.
5. After measurement, remove the gas analyzer probe, place the combustion analysis port cap back on, and reinstall the clamp to secure the cap in place.

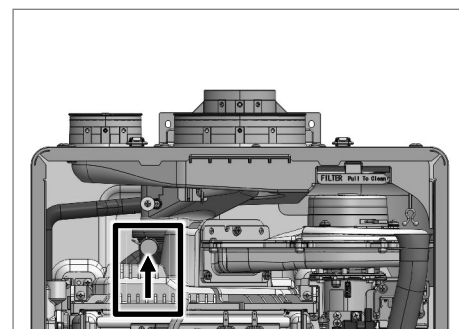

Insert gas analyzer probe into combustion analysis port.

Figure 142

14.5 Wiring Diagram

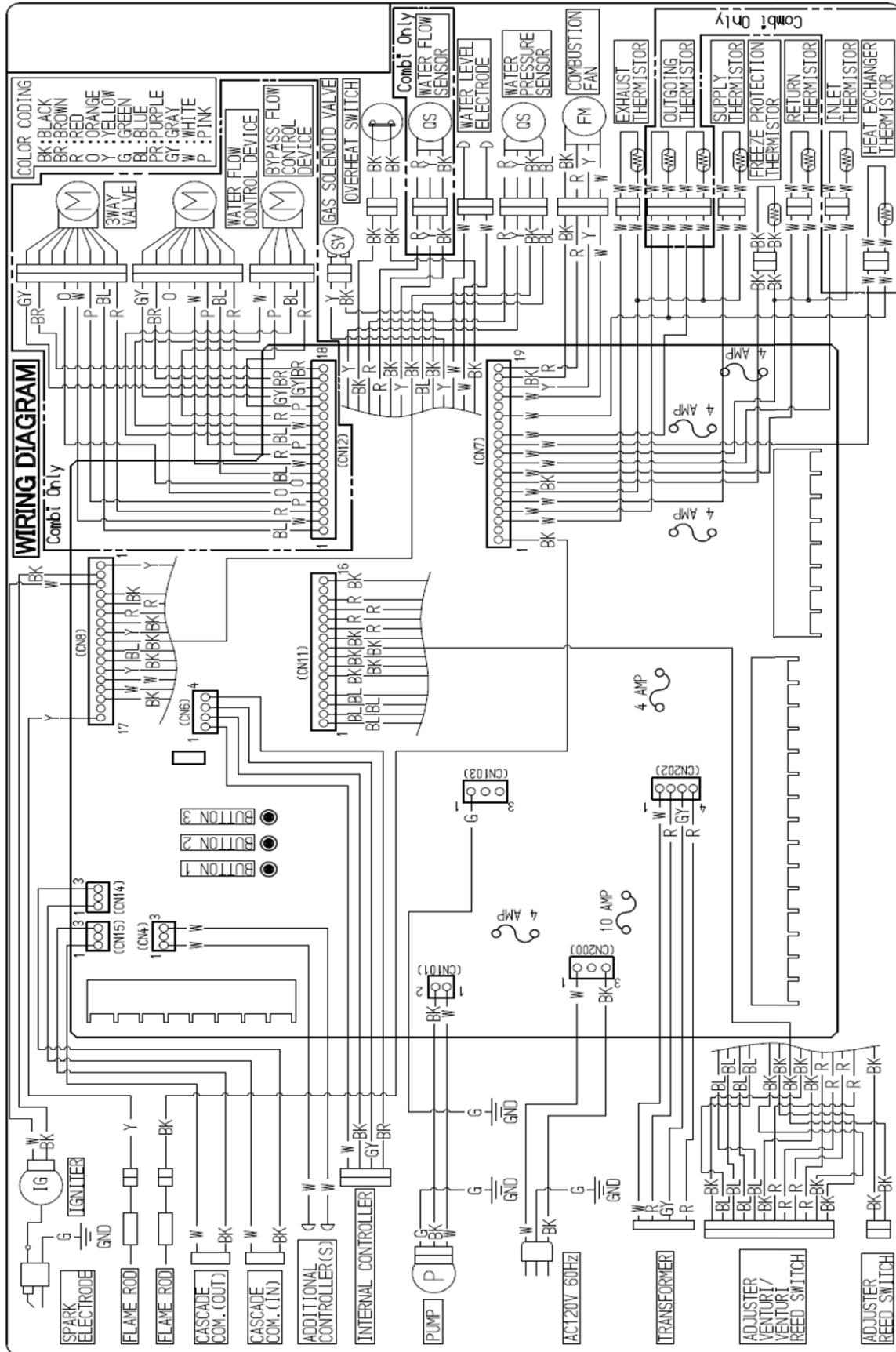

Figure 143

14.6 Ladder Diagram

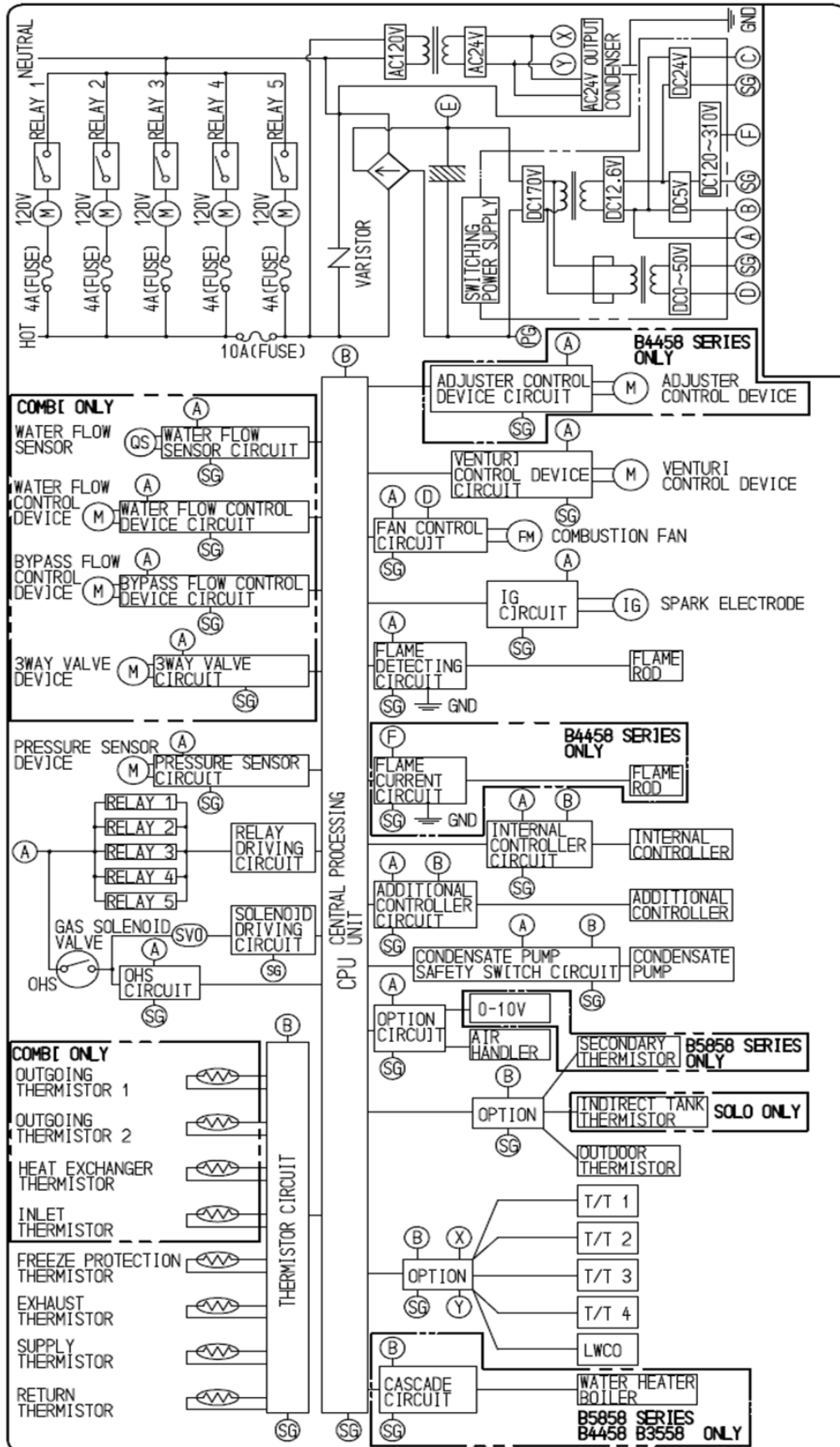

Figure 144

14.7 CH Pressure Drop and Flow Curve

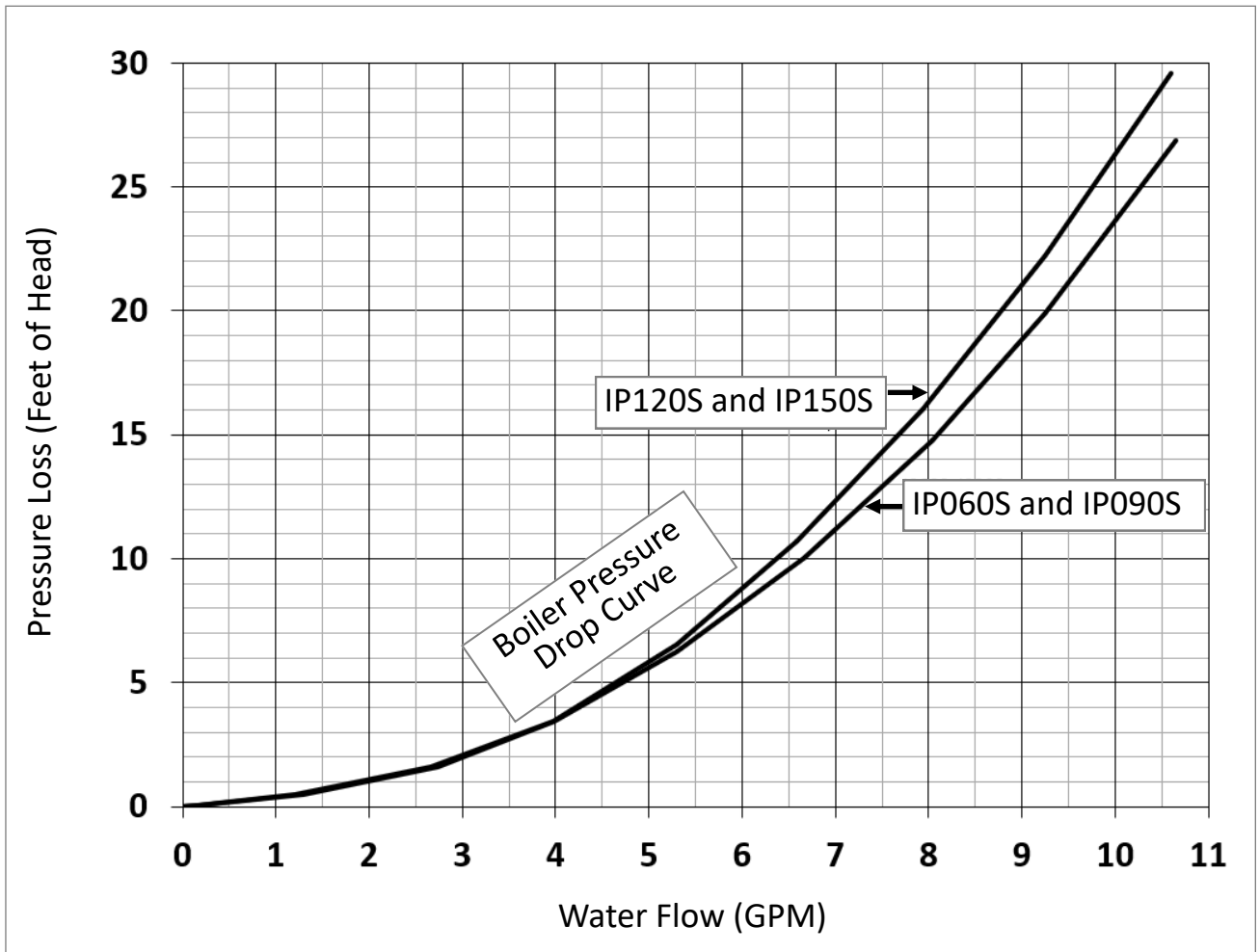

Figure 145

14.8 Remove a Boiler from a Common Vent System

The following information is required by ANSI Z21.13:

If a boiler is removed from a common vent system, the common vent system is likely to be too large for proper venting of the remaining appliances connected to it.

The instructions shall include the test procedure set forth below:

At the time of removal of an existing boiler, the following steps shall be followed with each other appliances remaining connected to the common venting system are not in operation.

1. Seal any unused openings in the common venting system.
2. Visually inspect the venting system for proper size and horizontal pitch and determine there is no blockage or restriction, leakage, corrosion and other deficiencies which could cause an unsafe condition.
3. Insofar as is practical, close all building doors and windows and all doors between the space in which the appliances remaining connected to the common venting system are located and other spaces of the building. Turn on clothes dryers and any appliance not connected to the common venting system. Turn on any exhaust fans, such as range hoods and bathroom exhausts, so they will operate at maximum speed. Do not operate a summer exhaust fan. Close fireplace dampers.
4. Place in operation the appliance being inspected. Follow the lighting instructions. Adjust thermostat so appliance will operate continuously.
5. Test for spillage at the draft hood relief opening after five minutes of main burner operation. Use the flame of a match or candle, or smoke from a cigarette, cigar, or pipe.
6. After it has been determined that each appliance remaining connected to the common venting system properly vents when tested as outlined above, return doors, windows, exhaust fans, fireplace dampers, and any other gas-burning appliance to their previous condition of use.
7. Any improper operation of the common venting system should be corrected so the installation conforms with the National Fuel Gas Code, ANSI Z223.1/NFPA 54, and/or the Natural Gas and Propane Installation Code, CAN/CSA B149.1. When resizing any portion of the common venting system, the common venting system should be resized to approach the minimum size as determined using the appropriate tables in Chapter 13 of the National Fuel Gas Code, ANSI Z223.1/NFPA 54, and/or the Natural Gas and Propane Installation Code, CAN/CSA B149.1.

14.9 Massachusetts State Gas Regulations

FOR GAS MODELS SOLD IN MASSACHUSETTS

NOTICE BEFORE INSTALLATION:

This direct-vent appliance must be installed by a properly trained licensed professional. If you are not properly trained, you must not install this unit.

IMPORTANT: In the State of Massachusetts (248 CMR 4.00 & 5.00):

For all side wall horizontally vented gas fueled equipment installed in every dwelling, building or structure used in whole or in part for residential purposes, including those owned or operated by the Commonwealth and where the side wall exhaust vent termination is less than 7 ft above finished grade in the area of the venting, including but not limited to decks and porches, the following requirements shall be satisfied:

1. **INSTALLATION OF CARBON MONOXIDE DETECTORS.** At the time of installation of the side wall horizontal vented gas fueled equipment, the installing plumber or gasfitter shall observe that a hard wired carbon monoxide detector with an alarm and battery back-up is installed on the floor level where the gas equipment is to be installed. In addition, the installing plumber or gasfitter shall observe that a battery operated or hard wired carbon monoxide detector with an alarm is installed on each additional level of the dwelling, building or structure served by the side wall horizontal vented gas fueled equipment. It shall be the responsibility of the property owner to secure the services of qualified licensed professionals for the installation of hard wired carbon monoxide detectors
 - A. In the event that the side wall horizontally vented gas fueled equipment is installed in a crawl space or an attic, the hard wired carbon monoxide detector with alarm and battery back-up may be installed on the next adjacent floor level.
 - B. In the event that the requirements of this subdivision can not be met at the time of completion of installation, the owner shall have a period of thirty (30) days to comply with the above requirements; provided, however, that during said thirty (30) day period, a battery operated carbon monoxide detector with an alarm shall be installed.
2. **APPROVED CARBON MONOXIDE DETECTORS.** Each carbon monoxide detector as required in accordance with the above provisions shall comply with NFPA 720 and be ANSI/UL 2034 listed and IAS certified.
3. **SIGNAGE.** A metal or plastic identification plate shall be permanently mounted to the exterior of the building at a minimum height of 8 ft above grade directly in line with the exhaust vent terminal for the horizontally vented gas fueled heating appliance or equipment. The sign shall read, in print size no less than one-half (1/2) inch in size, **"GAS VENT DIRECTLY BELOW. KEEP CLEAR OF ALL OBSTRUCTIONS."**
4. **INSPECTION.** The state or local gas inspector of the side wall horizontally vented gas fueled equipment shall not approve the installation unless, upon inspection, the inspector observes carbon monoxide detectors and signage installed in accordance with the provisions of 248 CMR 5.08(2)(a)1 through 4.

14.10 Federal Communication Commission (FCC) Interference Statement

FCC Interference Statement:

This device complies with Part 15 of the FCC Rules. Operation is subject to the following two conditions: (1) This device may not cause harmful interference, and (2) this device must accept any interference received, including interference that may cause undesired operation.

This equipment has been tested and found to comply with the limits for a Class B digital device, pursuant to Part 15 of the FCC Rules. These limits are designed to provide reasonable protection against harmful interference in a residential installation. This equipment generates, uses and can radiate radio frequency energy and, if not installed and used in accordance with the instructions, may cause harmful interference to radio communications. However, there is no guarantee that interference will not occur in a particular installation. If this equipment does cause harmful interference to radio or television reception, which can be determined by turning the equipment off and on, the user is encouraged to try to correct the interference by one of the following measures:

- Reorient or relocate the receiving antenna.
- Increase the separation between the equipment and receiver.
- Connect the equipment into an outlet on a circuit different from that to which the receiver is connected.
- Consult the dealer or an experienced radio/TV technician for help.

FCC Caution: Any changes or modifications not expressly approved by the party responsible for compliance could void the user's authority to operate this equipment.

This transmitter must not be co-located or operating in conjunction with any other antenna or transmitter.

Radiation Exposure Statement:

The product comply with the FCC portable RF exposure limit set forth for an uncontrolled environment and are safe for intended operation as described in this manual. The further RF exposure reduction can be achieved if the product can be kept as far as possible from the user body or set the device to lower output power if such function is available.

14.11 Industry Canada Statement

IC

This device complies with ISED's licence-exempt RSSs. Operation is subject to the following two conditions: (1) This device may not cause harmful interference, and (2) this device must accept any interference received, including interference that may cause undesired operation.

Le présent appareil est conforme aux CNR d'ISED applicables aux appareils radio exempts de licence. L'exploitation est autorisée aux deux conditions suivantes : (1) le dispositif ne doit pas produire de brouillage préjudiciable, et (2) ce dispositif doit accepter tout brouillage reçu, y compris un brouillage susceptible de provoquer un fonctionnement indésirable.

Radiation Exposure Statement:

This equipment complies with ISED radiation exposure limits set forth for an uncontrolled environment. This equipment should be installed and operated with minimum distance 20cm between the radiator & your body.

Déclaration d'exposition aux radiations:

Cet équipement est conforme aux limites d'exposition aux rayonnements ISED établies pour un environnement non contrôlé. Cet équipement doit être installé et utilisé avec un minimum de 20 cm de distance entre la source de rayonnement et votre corps.

14.12 Warranty

Limited Warranty for I-Series Plus Boiler Models

Boiler Models:

- IP060S (REB-B1800FF-US)
- IP090S (REB-B2600FF-US)
- IP120S (REB-B3500FF-US)
- IP150S (REB-B4400FF-US)

What Is Covered?

The Rinnai Standard Limited Warranty covers any defects in materials or workmanship when the product is installed and operated according to Rinnai written installation instructions, subject to the terms within this Limited Warranty document. This Limited Warranty applies only to products that are installed in the United States and Canada. Improper installation may void this Limited Warranty. It is strongly recommended that you use a trained and qualified professional who has attended a Rinnai installation training class before installing this boiler. This Limited Warranty is subject to the conditions that the Rinnai boiler has been installed and proper maintenance has been performed, according to the Installation and Servicing Instructions, by a professional heating contractor. Proof of the required service and maintenance must be kept in the provided Rinnai Installation, Commissioning and Service Record. This Limited Warranty coverage as set out in the table below extends to the original purchaser and subsequent owners, but only while the product remains at the site of the original installation. This Limited Warranty only extends to the first / original installation of the product and terminates if the product is moved or reinstalled at a new location.

Table 47

Item	Residential Applications	Commercial Applications
Heat Exchanger	12 Years	5 Years
All Other Parts and Components*	5 Years	5 Years
Reasonable Labor	1 Year	1 Year

* Parts replaced during recommended maintenance procedures are not covered by this Limited Warranty.

What Will Rinnai Do?

Rinnai will repair or replace the covered product or any part or component that is defective in materials or workmanship as set forth in the above table. Rinnai will pay reasonable labor charges associated with the repair or replacement of any such part or component during the term of the labor warranty period. All repair parts must be genuine Rinnai parts. All repairs or replacements must be performed by a licensed professional who is properly trained to do the type of repair.

Replacement of the product may be authorized by Rinnai only at its sole discretion. Rinnai does not authorize any person or company to assume for it any obligation or liability in connection with the replacement of the product. If Rinnai determines that repair of a product is not possible, Rinnai may replace the product with a comparable product at Rinnai's sole discretion. The warranty claim for product parts and labor may be denied if a component or product returned to Rinnai is found to be free of defects in material or workmanship; damaged by improper installation, use or operation; or damaged during return shipping.

How Do I Get Service? You must contact a trained and qualified professional for the repair of a product under this Limited Warranty. For the name of a trained and qualified professional, please contact your place of purchase, visit the Rinnai website (www.rinnai.us), call Rinnai at 1-800-621-9419 or write to Rinnai at 103 International Drive, Peachtree City, Georgia 30269.

Proof of purchase is required to obtain warranty service. You may show proof of purchase with a dated sales receipt, or by registering within 90 days of purchasing the product. To register your Rinnai Condensing Boiler, please visit www.rinnai.us. For those without internet access, please call 1-866-RINNAI1 (746-6241). Receipt of Registration by Rinnai will constitute proof-of-purchase for this product. Registration of product installed in new home construction may be verified with a copy of the closing papers provided by the initial home buyer. However, Registration is not necessary in order to validate this Limited Warranty.

What Is Not Covered? This warranty does not cover any failures, heat exchanger leakage, or operating difficulties due to the following:

- Accident, abuse or misuse
- Alteration
- Misapplication
- Force majeure
- Improper installation (such as but not limited to inadequate water quality, condensate damage, improper venting, incorrect gas type, incorrect gas or water pressure, or absence of a drain pan under the product)
- Improper maintenance (such as but not limited to scale build-up, freeze damage, or vent blockage)
- Improper water quality or the use of unapproved antifreeze or other chemical additives in the boiler system
- Installation of the boiler in a heating system where polybutylene pipe without an oxygen barrier is used
- Any installation that is not closed loop or where oxygen may enter the heating system
- Use in or around areas where chemical agents are used (such as but not limited to chlorine, hair spray, or hair dyes)
- Damage or failure caused by contaminated air, including, but not limited to sheetrock particles, plasterboard particles, dust, dirt, or lint entering the boiler or any of its components
- Incorrect sizing
- A failure of any component in the Hydronic system not supplied by Rinnai
- Any other causes other than defects in materials or workmanship

This Limited Warranty does not cover any product used in an application that uses chemically treated water such as a pool or spa heater.

If you purchase a Rinnai product from an unauthorized dealer, or if the original factory serial number has been removed, defaced or altered, your Rinnai warranty will not be valid.

Limitation on Warranties — No one is authorized to make any other warranties on behalf of Rinnai America Corporation. Except as expressly provided herein, there are no other warranties, expressed or implied, including, but not limited to warranties of merchantability or fitness for a particular purpose, which extend beyond the description of the warranty herein.

Any implied warranties of merchantability and fitness arising under state law are limited in duration to the period of coverage provided by this Limited Warranty, unless the period provided by state law is less. Some states do not allow limitations on how long an implied Limited Warranty lasts, so the above limitation may not apply to you.

Rinnai shall not be liable for indirect, incidental, special, consequential or other similar damages that may arise, including lost profits, damage to person or property, loss of use, inconvenience, or liability arising from improper installation, service or use. Some states do not allow the exclusion or limitation of incidental or consequential damages, so the above limitation may not apply to you.

This Limited Warranty gives you specific legal rights, and you may also have other rights which vary from state to state. www.rinnai.us/warranty

Notes

Notes

Rinnai America Corporation

103 International Drive
Peachtree City, GA 30269
Tel. 1-800-621-9419
Web. www.rinnai.us
www.rinnai.ca

800000191(02)
10/2024