



OWNER'S MANUAL

CEILING MOUNT HEATER

15,000W / 10,000W | 240V



MODEL: 1VAHG15000

CONTENTS

SAFETY INFORMATION	4
SPECIFICATIONS	6
MOUNTING INSTRUCTIONS	7
USAGE INSTRUCTIONS	8
INSTALLATION INSTRUCTIONS	10
CONNECTING THE POWER.....	11
SAFETY INSTRUCTIONS	12
CARE & MAINTENANCE.....	12
WARRANTY	13
TROUBLESHOOTING.....	14

HARDWIRED INSTALLATION REQUIRED

This heater must be grounded and hardwired to a properly sized current protection circuit breaker in accordance with the (US) National Electric Code and local codes.

DESCRIPTION

- Adjustable Heat Settings with Digital Thermostat
- Fan Only Setting for Year-Round Air Circulation
- Fully Enclosed Motor for Extended Use in Dusty Environments
- Horizontal and Vertical Air Flow with Tilt Feature
- Sturdy Heavy Gauge Steel Body
- Remote Control
- High Limit Thermal Cut-Out Switch

NOTE: SAVE THESE INSTRUCTIONS

SAFETY INFORMATION

INTENDED USE:

Electric Utility heaters are designed to meet a variety of heating requirements. This product is intended for indoor use only. Use only with electrical wiring that is in good working order and that meets applicable codes and ordinances.

If you have any questions whether your wiring is adequate, consult a qualified electrician. Risk of fire, overheating, malfunction, property damage, injury or even death may result if not adhered to.

Use your heater-fan only with a working smoke detector located in the vicinity of your heater-fan.

While using your heater-fan, you should follow the IMPORTANT INSTRUCTIONS listed below.

As part of those instructions, we have used the word "**WARNING**" to indicate the level of hazard:

WARNING indicates a hazard which, if not avoided, could result in injury or death.

GENERAL SAFETY INFORMATION

WARNING-Read and understand installation and operation instructions and observe all safety instructions

SAVE THESE INSTRUCTIONS

1. For supply connections, use only copper wire, **see SPECIFICATIONS**
2. Heater air flow must be directed parallel to, or away from adjacent wall.
3. Observe wall, floor, and ceiling clearance requirements, **see Figure 1**.
4. All wiring must conform to national and local electrical codes in the United States and the heater must be grounded as a precaution against possible electrical shock. Heater circuit must be protected with proper fuses or circuit breakers.
5. The mounting structure and the anchoring hardware must be capable of reliably supporting the weight of the heater and, if used, the mounting bracket.
6. All electrical power must be disconnected, and the main service box must be locked before inspection, cleaning or servicing the heater. This is a precaution to prevent serious shock.

7. This heater is not suitable for use in hazardous locations as defined by the National Fire Protection Association (NFPA) in the United States. This heater has hot and arcing (sparking) parts inside. Do not use in areas where gasoline, paint, or flammable liquids are used or stored.
8. This heater is not suitable for use in corrosive atmosphere such as marine, greenhouses or chemical storage areas.
9. Do not install closer than **8 inches** to a vertical surface. Do not install less than **6 feet** from the floor.
10. Extreme caution is necessary when any heater is used by or near children or invalids and whenever the heater is left operating and unattended.
11. Use this heater only as described in this manual. Any other use not recommended by the manufacturer may cause fire, electric shock, or injury to persons.
12. Hyperthermia can result in death. Symptoms of hyperthermia include high body temperature, headache, nausea, vomiting, tiredness, dizziness, fainting, and rapid pulse. If you begin to experience symptoms related to hyperthermia, turn off the heater and seek medical attention.
13. To avoid excessive room temperatures which can cause hyperthermia: **DO NOT** leave product running unattended in a confined space around infants, or individuals with reduced physical, sensory, or mental capabilities.

WARNING-Improper installation or failure to follow the procedures outlined in this instruction manual can result in serious electrical shock.

READ & SAVE THESE INSTRUCTIONS

⚠ WARNING SHOCK HAZARD

Use your heater only in dry environments. This heater is not intended for use in a bathroom, laundry area, or similar locations, or near sinks, washing machines, swimming pools or other sources of water. Never locate heater where it may fall into a bathtub or other water container. Do not use heater outdoors. Do not use in damp environments such as flooded basements.

⚠ WARNING HOT SURFACES

Do not touch body of heater when in use. This heater is hot when in use, to avoid burns, do not let bare skin touch hot surfaces. If provided, use handles when moving this heater.

⚠ WARNING FIRE HAZARD

Heater has hot and arcing or sparking parts inside. Do not use near combustible materials or flammable gases or sources of heat. **DO NOT USE** in areas where gasoline, paint or flammable materials are used or stored. Keep combustible materials such as furniture, pillows, bedding, papers, clothes and curtains at least 3 feet (0.9 m) from the front of the heater and keep them away from the sides and rear. Keep rear grille away from walls or drapes so as to not block air intake. To prevent a possible fire, do not block air intakes or exhaust in any manner. Do not use on soft surfaces, like a bed, where openings may become blocked. Do not insert or allow foreign objects to enter any ventilation or exhaust opening as this may cause an electric shock, fire, or damage the heater.

⚠ WARNING ELECTRICAL SHOCK HAZARD

Do not use with damaged wiring. Use with adequate electrical system that is up to code.

Do not operate any heater with a damaged cord or plug or after heater malfunctions, has been dropped or damaged in any manner. Do not operate heater with a broken heating element or ceramic cone or any visual imperfections.

PET OWNERS NOTE:

The health of birds and some small pets are extremely sensitive to the fumes given off during the initial use of many appliances. Although these fumes are not harmful to humans, it is recommended that this heater not be used around birds and small pets during its initial use until the manufacturing corrosion coatings burn off.

CONTINUOUS OPERATION AND TIMER USE

⚠ WARNING

- Plug directly into a wall outlet. Do not use an extension cord, power strip, surge protector, outlet adapter, or any other type of cord extension.
- Do not use the space heater in an outlet that is loose or does not hold the plug securely.
- Do not operate the unit if the power cord, plug, or outlet is damaged, loose, or overheating.
- This unit is not designed for unattended use or continuous operation for indefinite periods.
- If this unit includes a timer, the timer function is provided solely for convenience. It is not a safety device and is not a substitute for active supervision.
- Periodically turn the unit off and discontinue use immediately if any abnormal operation is observed.

IMPORTANT SAFETY WARNING - PACKAGING REMOVAL

⚠ WARNING

DO NOT operate this unit while it is inside, resting on, or in contact with Styrofoam, foam blocks, plastic bags, tape, or any packaging materials.

FAILURE TO REMOVE ALL PACKAGING MATERIALS BEFORE USE MAY RESULT IN OVERHEATING, MELTING, SMOKE, FIRE, PROPERTY DAMAGE, OR PERSONAL INJURY.

SPECIFICATIONS

1HSHG15000C DIGITAL HEAVY DUTY 15 ,000W ELECTRIC UTILITY HEATER					
WATTS	SWITCH POSITION	VOLTS (VAC)	PHASE	AMPS	BTU/HOUR
15,000W	HIGH (Default)	208-240V, 60Hz	1	62.5	51,200
N/A	MEDIUM	N/A	N/A	N/A	N/A
10,000W	LOW	208-240V, 60Hz	1	41.7	34,120
N/A	FAN ONLY	N/A	N/A	N/A	N/A
AIR THROW	HORIZONTAL	18 FT (APPROXIMATE)			
RECOMMENDED	CIRCUIT BREAKER	75 AMP	or larger , in accordance with NEC and local codes		
RECOMMENDED	WIRE SIZE	4 AWG, COPPER ONLY RATED AT 167°F/75°C	or larger , hardwired in accordance with NEC and local codes		
RECOMMENDED LUG TORQUES		45 IN-LBS	or greater , in accordance with NEC and local codes		
PRODUCT WEIGHT (APPROXIMATE)		BETWEEN 45 TO 55 LBS			

MOUNTING INSTRUCTIONS

Figure 1

NOTE: Diagram is not drawn to scale, for information purposes only.

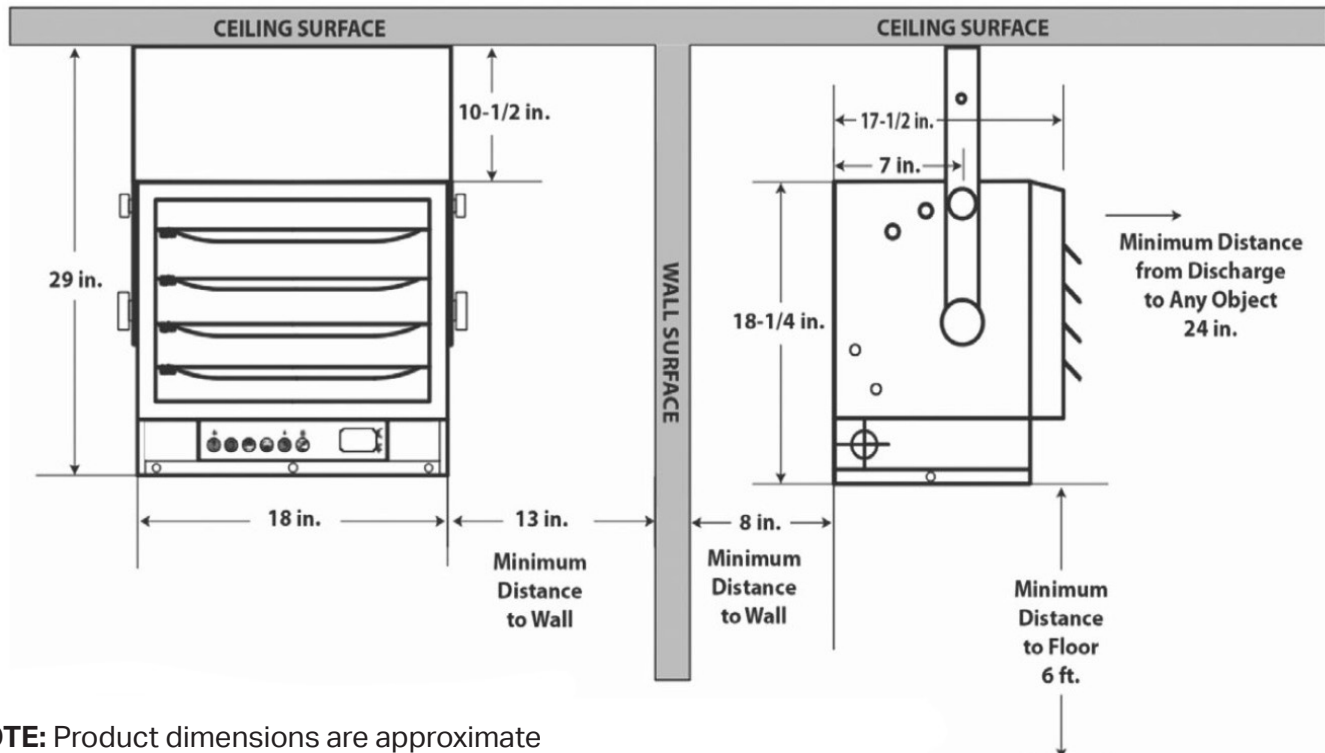

NOTE: Product dimensions are approximate and subject to change without notice.

⚠ WARNING FOR INDOOR USE ONLY, IN A DRY LOCATION FREE OF GASOLINE, PAINT, FLAMMABLE LIQUIDS OR COMBUSTIBLE DUST OR MATERIALS. DO NOT USE EXTENSION CORDS.

MAXIMUM MOUNTING HEIGHT USING BRACKET FOR:

VERTICAL AIR FLOW:

The maximum recommended ceiling height for effective vertical air flow is 11 ft.

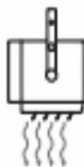

HORIZONTAL / ANGLED AIR FLOW:

The maximum recommended ceiling height for effective vertical air flow is 8 ft.

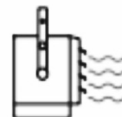

USAGE INSTRUCTIONS

BEFORE USING THIS PRODUCT:

- Remove the unit completely from the carton.
- Remove ALL Styrofoam, foam inserts, plastic coverings, tape, and protective materials
- Inspect all air intake and exhaust openings to ensure they are fully clear and unobstructed.

⚠ NEVER attempt to operate the unit while packaging materials are attached or nearby.

FOR SAFE OPERATION:

- Stop using immediately if unusual noise, odor, or abnormal operation occurs.
- Do not operate this unit unattended for extended periods of time.
- Keep the heater out of reach of children and pets during operation.
- Do not rely on the timer function as a substitute for supervision.
- This heater is intended for **indoor, dry-location use only.**
- Do not operate outdoors or in damp environments.
- Do not place the heater on soft surfaces such as beds, sofas, or thick carpeting that may restrict airflow.
- Maintain proper clearances and ventilation during operation.
- Do not insert or allow foreign objects to enter ventilation or exhaust openings.
- Do not modify the plug or attempt to bypass built-in safety features.
- Always unplug the unit when not in use or before cleaning or maintenance.
- Allow the unit to cool before moving or storing.
- Turn the unit off periodically to allow internal components to cool.

⚠ Failure to follow these instructions may result in damage to the unit or unsafe operating conditions.

CONTROL PANEL DETAIL

(enlarged for clarity)

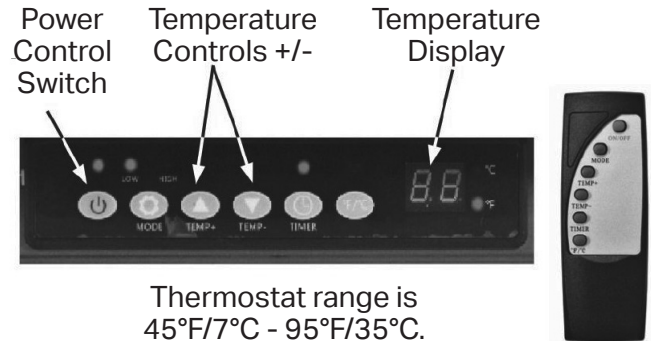

Figure 2

OPERATION AND TEMPERATURE SETTING

1. This heater is designed to maintain a comfortable room temperature. Always operate the heater in the upright position following all instructions and recommendations listed in this manual.
2. When the heater is turned on by pressing the POWER button, it will operate on HIGH setting (15,000W) continuously. The LED display panel will show the ambient temperature. Press the MODE button on either the unit or remote to change the heat setting to LOW (10,000W). The fan will start running about 5 seconds after initial start to push the heat out. The sequence is HIGH-LOW-FAN-ONLY. To operate the unit on FAN ONLY setting, press the MODE button again. In FAN ONLY mode, the LED display panel will show FA to indicate the heater is in FAN ONLY mode. From FAN ONLY mode, pressing the MODE button will make the heater operate in HIGH setting again, and the ambient temperature will appear on the LED display.
3. The temperature setting can be adjusted between 45°F (7°C) to 95°F (35°C). To change the temperature, press the TEMP+ or TEMP- buttons on either the unit or the remote. (See Figure 2)

4. The remote control has an approximate operating range of 16 ft (5 m).
5. The temperature display will blink while it is being adjusted. When the desired temperature is reached, it will take about 5 seconds to accept the setting. Once the display stops flashing, the room temperature will reappear on the LED screen to indicate the desired temperature is set.
6. In any temperature mode, the unit will stay in that mode, cycling on and off to maintain the set temperature.
7. The heater can be turned OFF by pressing the POWER button. Once the unit is turned off, the fan will continue to run to cool down the unit and there will be a 90 seconds countdown on the digital display.

TIMER FUNCTION:

The Timer function allows you to set the length of operation from 1 to 12 hours. Each time the TIMER button is pressed the length of operation will increase 1 hour. The duration the timer is set for will be displayed on the LED screen in hour increments.

TO TURN THE TIMER FUNCTION OFF:

Press the TIMER Button continuously until the LED screen displays "0".

NOTE: The timer function is not an excuse to leave the heater unattended.

NOTE: Heater will cycle on and off to maintain room temperature. The first time you operate the unit, it may smoke slightly. This is due to residual cleaning agents used to clean the element when the heater is manufactured. This is normal and does not indicate a problem with the unit. This condition will stop after the heater has been in operation for a few minutes.

FAHRENHEIT OR CELSIUS DISPLAY:

To switch the display between Fahrenheit and Celsius, press the °F/°C on either the unit or the remote.

INSTALLING THE HEATER:

LOCATING THE HEATER:

Install the heater out of traffic areas, maintaining the clearances stated in **Figure 1**. The air flow from the heater must not be restricted or obstructed by any items in the room. When more than one heater is used in an area, the heaters should be arranged so that the air discharge of each heater supports the air flow of the others to provide best circulation of warm air, as indicated below in **Figure 3**.

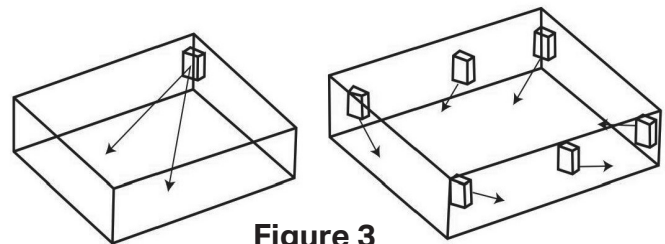

Figure 3

INSTALLATION

BRACKET INSTALLATION

Refer to **Figure 4**.

1. Locate a ceiling joist or other firm structural element or support to mount the heater and point at desired direction of air flow.
2. Drill a 1/4" pilot hole in the ceiling joist for the screw(s).
3. Place the screw(s) and washers as shown in the **Figure 4**.
4. Tighten the screws to secure the heater.

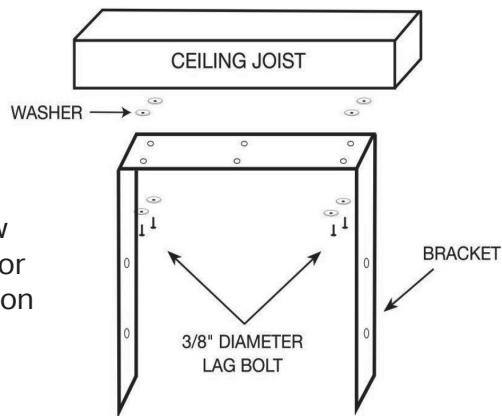
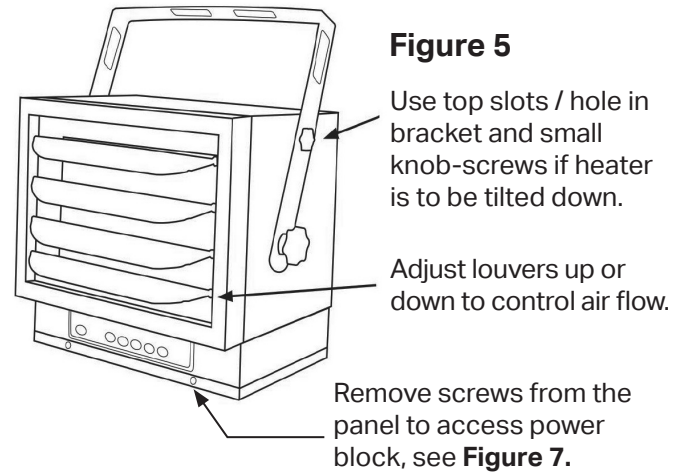

Figure 4:
Multi-Screw
Mounting, for
Fixed Position

HANGING THE HEATER IN THE BRACKET

1. Lift the heater into the mounting bracket and align the lower bracket holes with the threaded holes nearest the heater's center.
2. Thread a large knob-screw through the hole on each side of the bracket.
3. Aim the heater horizontally or tilted by aligning the upper bracket holes with the top threaded holes on the heater and secure with the small knob-screws and tighten all. See **Figure 5**.



CONNECTING THE POWER

1. With the power off at the breaker, remove all screws from the bottom lid for access to the electrical section of the heater.
2. Attach flexible cable through a knock-out in the side of the heater following NEC and local codes, (See **Figure 6**) and **SPECIFICATIONS** for recommended wiring and circuit breakers.

NOTE: For certain applications, conduit may be required (See **Figure 6**). Check local electrical codes. If you run the wiring in conduit and wish to be able to turn the heater, be sure to purchase enough flexible conduit to allow the heater to be turned.

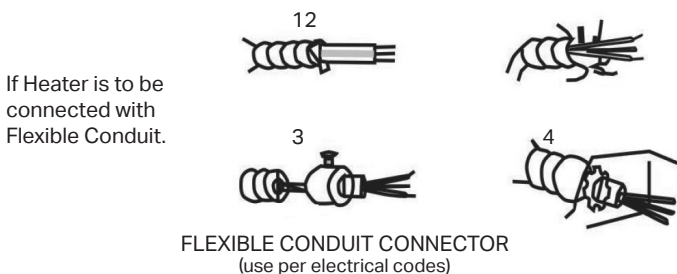
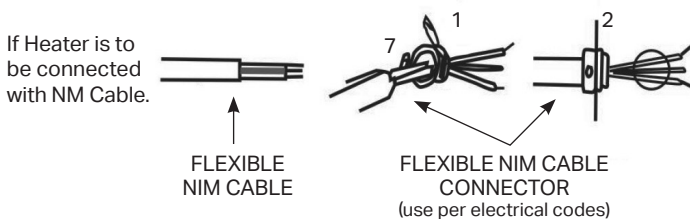
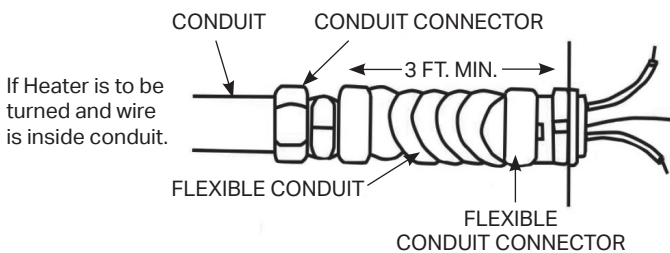

Figure 6

3. Pull enough wire into the heater and connect to wire to the Power Block located in the electrical area of the heater (See **Figure 7**).
4. Be sure to torque all terminal screws and power block lugs tight, see **SPECIFICATIONS** and NEC/local codes, for required **torque values**, failure to do so can overheat the power blocks.
5. Turn on power at the main circuit breaker panel. Notice the **YELLOW** Power Indicator Light on the Control Panel will glow.

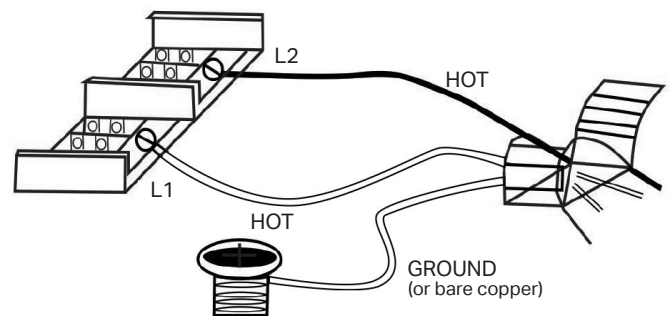

Figure 7

WARNING: It is advised that at the start of each heater season, the power should be turned off at the circuit breaker and the L1 & L2 lug screws checked for tightness and **proper torque**. The heater should be cleaned and checked for mechanical and electrical integrity. See **SPECIFICATIONS** and NEC/local codes.

ADJUSTING AIR FLOW

1. **Tilt the unit**—Loosen the top Small Knob-Screws and thread into provided holes in heater until tight. See **Figure 5**.
2. **Adjust the louvers** in front of the heater as desired. See **Figure 5**.

NOTE: DO NOT OPERATE THE HEATER WITH THE FRONT LOUVERS CLOSED, DAMAGE TO THE HEATER COULD RESULT.

CARE & MAINTENANCE

SAFETY INSTRUCTIONS

To start the heater, turn on the circuit breaker. The Power Indicator light will light up to indicate there is power available. Press the POWER button to turn the heater on. The heater will be in HIGH setting by default. The heater indicator will illuminate, and the LED display will show the default setting temperature 80°F.

1. The heater is HOT when in use. Do not let bare skin touch any hot surfaces.
2. Keep combustible materials (furniture, pillows, bedding, papers, clothes, curtains, and similar items) at least 3 feet (0.9m) from all sides and surfaces of the heater.
3. Do not use outdoors or in wet areas like bathrooms, laundry areas or where it could fall into a swimming pool or other container of water.
4. This heater is a 240V AC rated direct wired appliance. Never use extension cords or relocatable power taps.

CARE & MAINTENANCE

CLEANING THE HEATER:

1. Do not disassemble the heater to clean it.
2. The heater should be powered OFF and disconnected from the power at the circuit breaker before attempting to clean any portion of the heater.
3. The exterior can be cleaned with a cloth, brush and/or vacuum.
4. The louvers, fan blades, and heating element are delicate and should be gently cleaned by brush, vacuum, and mild compressed air.

WARRANTY

⚠ WARNING USE ONLY MANUFACTURER'S REPLACEMENT PARTS. USE OF ANY OTHER PARTS COULD CAUSE INJURY OR DEATH. REPLACEMENT PARTS ARE ONLY AVAILABLE DIRECT FROM THE FACTORY AND MUST BE INSTALLED BY A QUALIFIED SERVICE AGENCY.

PARTS ORDERING INFORMATION

PURCHASING

Accessories may be purchased at any VisionAir local dealer or direct from the factory.

FOR INFORMATION REGARDING SERVICE

Please call Toll-Free 833-950-1185.

WWW.VISIONAIRPRODUCTS.COM

Our office hours are 8:00 AM–5:00 PM, EST, Monday through Friday.

Please include the model number, date of purchase, and description of problem in all communication.

LIMITED WARRANTY

The company warrants this product to be free from imperfections in material or workmanship, under normal and proper use in accordance with instructions of The Company, for a period of one year from the date of delivery to the buyer. The Company, at its option, will repair or replace products returned by the buyer to the factory, transportation prepaid within said one year period and found by the Company to have imperfections in material or workmanship.

If a part is damaged or missing, call our Technical Support Department at 833-950-1185.

Address any Warranty Claims to the Service Department, VisionAir, 4560 W. 160th St., Cleveland, Ohio 44135. Include your name, address and telephone number and include details concerning the claim. Also, supply us with the purchase date and the name and address of the dealer from whom you purchased our product.

The foregoing is the full extent of the responsibility of the Company. There are no other warranties, express or implied. Specifically there is no warranty of fitness for a particular purpose and

there is no warranty of merchantability. In no event shall the Company be liable for delay caused by imperfections, for consequential damages, or for any charges of the expense of any nature incurred without its written consent. The cost of repair or replacement shall be the exclusive remedy for any breach of warranty. There is no warranty against infringement of the like and no implied warranty arising from course of dealing or usage of trade. This warranty will not apply to any product which has been repaired or altered outside of the factory in any respect which in our judgment affects its condition or operation. Some states do not allow the exclusion or limitation of incidental or consequential damages, so the above limitation or exclusion may not apply to you. This Warranty gives you specific legal rights, and you may have other rights which vary from state to state.

VisionAir reserves the right to make changes at any time, without notice or obligation, in colors, specifications, accessories, materials and models.

TROUBLESHOOTING

ERROR CODE	POSSIBLE CAUSE	RECOMMENDED SOLUTION	CLEARING ERROR CODES
E1 (Fan Blade Not Spinning) Overheat Safety Cut-Out (Resettable)	Insufficient Clearance Around Heater	Ensure Heater is Installed with Sufficient Clearance All-Around, See Figure 1 . <ul style="list-style-type: none"> • 6 feet minimum mounting from floor • 8 inches minimum from rear of heater • 13 inches minimum from side of heater 	To Clear E1 Code: <ol style="list-style-type: none"> 1. Power Off Heater 2. Switch Off Breaker (or Remove Fuse) 3. Allow Heater to Cool (~15 minutes) 4. Switch on Breaker and wait 1 minute 5. Power On Unit and follow Instruction Manual for Normal Operation If E1 code persists please contact manufacturer to arrange product return.
	Obstructed Vent	Remove any objects on heater or adjacent to heater vents. Do not block intake or exhaust by columns, machinery, etc. Ensure 24 inches minimum distance from heater exhaust (front) to any object.	
	Fan Not Operational (Fan Blade Not Spinning)	Disconnect power! Inspect Fan Blade (Rear of Heater) for foreign or dislodged object(s) preventing rotation. Remove Rear Grille and clear interference, re-attach Rear Grille.	
		Disconnect power! Open Hinged Bottom Cover by removing screws. Inspect Circuit Card Assembly (adjacent to Supply Connection Terminal Block) for loose or detached "plug-in" electrical connector. Re-attach securely, close Bottom Cover and re-install screws.	
	Inadequate Copper Wire Gauge for Supply Connections (Fan Operates at Reduced Speed Due to Insufficient Power Input)	Consult a licensed electrician. Ensure Adequate Wire Gauge for Supply Connections	
	Excessive Distance from Power Source (Fan Operates at Reduced Speed Due to Current Loss)		
	Inadequate Current (Amp) Rating on Breaker	Consult a licensed electrician. Ensure adequately sized Current Breaker or Fuse per National & Local Electrical Codes.	
	Improper Heater Shut Down	Do not power off heater using circuit breaker. Fan motor is designed to operate for a short period of time after heating element shuts off to prevent an overheat condition.	

ERROR CODE	POSSIBLE CAUSE	RECOMMENDED SOLUTION	CLEARING ERROR CODES
<p>E2 Room Temp Sensor Open Circuit</p>	<p>Detached or Loose Connection at Room Temperature Sensor</p>	<p>Disconnect power! Detach Fan Grille by removing screws. Locate Temp Sensor Thermocouple on Housing (below Fan Motor Bracket). Ensure wire pair and thermocouple "tip" are free of damage. Re-attach Grille by re-installing screws. · Open Bottom Cover by removing screws. Inspect Circuit Card Assembly (adjacent to Supply Connection Terminal Block) for loose or detached "plug-in" electrical connector. Re-attach connectors securely. Close Bottom Cover and re-install screws.</p>	<p>To Clear E2 and E3 Codes:</p> <ol style="list-style-type: none"> 1. Power Off Heater 2. Switch Off Breaker (or Remove Fuse) 3. Switch on Breaker and wait 1 minute 4. Power On Unit and follow Instruction Manual for Normal Operation <p>If E2 or E3 code persists please contact manufacturer to arrange product return.</p>
<p>E3 Room Temp Sensor Short Circuit</p>	<p>Moisture Entrapment in Heater</p>	<p>Not intended for outdoor use. Not intended for use in bathrooms, shower rooms, laundry facilities or other similar indoor locations. Disconnect power! Open Bottom Cover by removing screws. Allow unit to fully dry. Re-attach securely, close Bottom Cover and re-install screw(s).</p>	
<p>No Power or Low Power to Heater</p>	<p>Supply Connections Improperly Wired</p>	<p>Consult a licensed electrician. Ensure Supply Connections L1, L2, L3 and Ground are secure. Torque per NEC (L3 provided on certain models).</p>	<p>Re-Start Unit. Follow Instruction Manual for Normal Operation.</p>
	<p>Insufficient Service Loop on Supply Connections</p>	<p>Consult a licensed electrician. Ensure sufficient service loop in supply wires to maintain secure electrical connections to swivel heater on bracket (particularly when using rigid or semi-rigid conduit).</p>	
	<p>Electrical Short-to Ground</p>	<p>Consult a licensed electrician. Ensure Supply Connections (L1, L2 and L3) are not contacting Housing (Ground) (L3 only provided on certain models).</p>	

NOTE: As a result of continual improvements, the design and specifications of the product within may differ slightly to the unit illustrated on the packaging.



4560 West 160th Street
Cleveland, OH 44135

833-950-1185 | www.visionairproducts.com

Mr. Heater trademark is used under license from Enerco Group, Inc.
© 2024, Mr. Heater. All rights reserved.

Printed in Cambodia | 0326_M025