

Operation Manual

Smart-UPS[™] Uninterruptible Power Supply

**750/1000/1500 VA
Short-depth Rack-Mount
with Lithium-ion batteries**

120 Vac

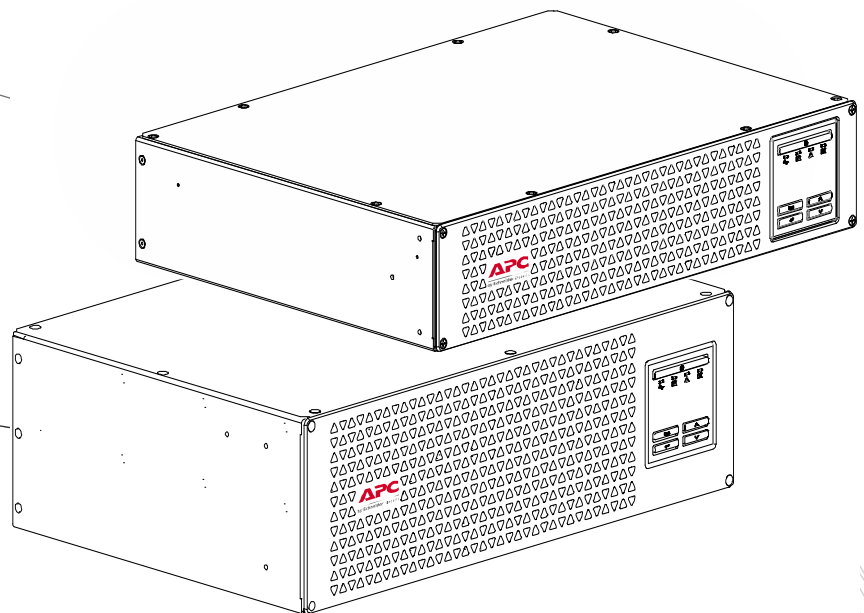

Important Safety Messages

SAVE THESE INSTRUCTIONS - This manual contains important instructions that should be followed during installation and maintenance of the UPS and batteries.

Read the instructions carefully and look at the equipment to become familiar with the device before trying to install, operate, service or maintain it. The following special messages may appear throughout this bulletin or on the equipment to warn of potential hazards or to call attention to information that clarifies or simplifies a procedure.



The addition of this symbol to either a “Danger” or “Warning” safety label indicates that an electrical hazard exists which will result in personal injury if the instructions are not followed.



This is the safety alert symbol. It is used to alert you to potential personal injury hazards. Obey all safety messages that follow this symbol to avoid possible injury or death.

DANGER

DANGER indicates a hazardous situation which, if not avoided, will result in death or serious injury.

WARNING

WARNING indicates a hazardous situation which, if not avoided, could result in death or serious injury.

CAUTION

CAUTION indicates a hazardous situation which, if not avoided, could result in minor or moderate injury.

NOTICE

NOTICE is used to address practices not related to physical injury.

Product Handling Guidelines



<18 kg
<40 lb



18-32 kg
40-70 lb



32-55 kg
70-120 lb



>55 kg
>120 lb



Safety and General Information

Inspect the package contents upon receipt. Notify the carrier and dealer if there is any damage.

General safety

- Adhere to all national and local electrical codes.
- All wiring must be performed by a qualified electrician.
- **Changes and modifications to this unit not expressly approved by APC by Schneider Electric could void the warranty.**
- This UPS is intended for indoor use only.
- Do not operate this unit in direct sunlight, in contact with fluids, or where there is excessive dust or humidity.
- Be sure the air vents on the UPS are not blocked. Allow adequate space for proper ventilation.
- For a UPS with a factory installed power cord, connect the UPS power cable directly to a wall outlet. Do not use surge protectors or extension cords.
- The equipment is heavy. Always practice safe lifting techniques adequate for the weight of the equipment.

Deenergizing safety

The UPS contains internal batteries and may present a shock hazard even when disconnected from the branch circuit (mains). Before installing or servicing the equipment check that the:

- Input circuit breaker is in the **OFF** position.
- Internal UPS batteries are removed.

Electrical safety

- Use tools with insulated handles.
- Do not handle any metallic connector before power has been disconnected.
- For models with a hardwired input, the connection to the branch circuit (mains) must be performed by a qualified electrician.
- 230 V models only: In order to maintain compliance with the EMC directive for products sold in Europe, output cords attached to the UPS must not exceed 10 meters in length.
- The protective earth conductor for the UPS carries the leakage current from the load devices (computer equipment). An insulated ground conductor is to be installed as part of the branch circuit that supplies the UPS. The conductor must have the same size and insulation material as the grounded and ungrounded branch circuit supply conductors. The conductor will typically be green, with or without a yellow stripe.
- Leakage current for a pluggable, Type A UPS may exceed 3.5 mA when a separate ground terminal is used.
- The UPS input ground conductor must be properly bonded to protective earth at the service panel.
- If the UPS input power is supplied by a separately derived system, the ground conductor must be properly bonded at the supply transformer or motor generator set.

Battery safety

- The battery typically lasts for five to ten years. Environmental factors impact battery life. Elevated ambient temperatures, poor quality utility power, and frequent short duration discharges will shorten battery life.
- For longest battery performance, the ambient temperature should be maintained between 68° and 77°F (20° and 25°C).
- Replace the UPS immediately if the unit indicates battery replacement is necessary.
- Replace the UPS once the batteries have reached the end of their service life even if the UPS has not indicated that battery replacement is necessary.
- The batteries are user replaceable. Under normal operating conditions, there is no need for replacement. If attempting to replace batteries,
 - Use only APC by Schneider Electric battery modules.
 - Do not use third-party batteries as replacements.
 - Replace with the same number and type of batteries as originally installed in the equipment.
- APC by Schneider Electric uses Lithium Ion batteries. Under normal use and handling, there is no contact with the internal components of the battery.
- Do not drive nails into the battery pack.
- Do not strike the battery pack with a hammer.
- Do not stand on the battery pack.
- Do not short circuit battery pack.
- Do not place or use the battery pack near heat or fire.
- Do not use a dropped, damaged or deformed battery pack.
- Do not use the battery pack to power other equipment.
- CAUTION: Before installing or replacing the batteries, remove conductive jewelry such as chains, wrist watches and rings. High energy through conductive materials could cause severe burns.
- CAUTION: Do not dispose of battery pack in a fire. The batteries may explode.
- CAUTION: Do not open or tamper with the battery enclosure. Doing so will expose the cell terminals which pose an energy hazard.

WARNING

RISK OF CHEMICAL HAZARD AND EXCESSIVE HEAT

- Replace the battery at least every 10 years.
- Replace the battery immediately when the UPS indicates battery replacement is necessary.
- Replace battery at the end of its service life.
- Replace batteries with the same number and type of batteries as originally installed in the equipment.
- Replace the battery immediately when the UPS indicates a battery over-temperature condition or UPS internal over-temperature. Power off the UPS, unplug it from the AC input, and disconnect the batteries. Do not operate the UPS until the batteries have been replaced.

Failure to follow these instructions can result in death or serious injury.

General information

- The model and serial numbers are located on a small label on the rear panel. For some models, an additional label is located on the chassis under the front bezel.
- Always recycle used batteries.
- Recycle the package materials or save them for reuse.

FCC Class A radio frequency warning

This equipment has been tested and found to comply with the limits for a Class A digital device, pursuant to part 15 of the FCC Rules. These limits are intended to provide reasonable protection against harmful interference when the equipment is operated in a commercial environment. This equipment generates, uses, and can radiate radio frequency energy and, if not installed and used in accordance with the instruction manual, may cause harmful interference to radio communications. Operation of this equipment in a residential area is likely to cause harmful interference in which case the user will be required to correct the interference at his own expense.

WARNING: This is a category C2 UPS product. In a residential environment, this product may cause radio interference, in which case the user may be required to take additional measures.

Specifications

For additional specifications, refer to the APC Web site at www.apc.com.

Environmental specifications

Temperature	Operating	0° to 40° C (32° to 104° F)
	Storage	-40° to 35° C (-40° to 95° F)
	Transporting	-40° to 80° C (-40° to 176° F)
Maximum Elevation	Operating	10,000 ft. (3,048 m)
	Storage	25,000 ft. (7,620 m)
	Transporting	50,000 ft. (15,240m)
Shelf Life	Storage	Limited by battery state of charge. If initial state of charge is 100%, batteries must be recharged when storage time exceeds 12 months.
	Transporting	2 weeks maximum
Humidity	0% to 95% relative humidity, non-condensing	

Dimensions and weights

SMTL750RM2UC / SMTL1000RM2UC Rack-Mount

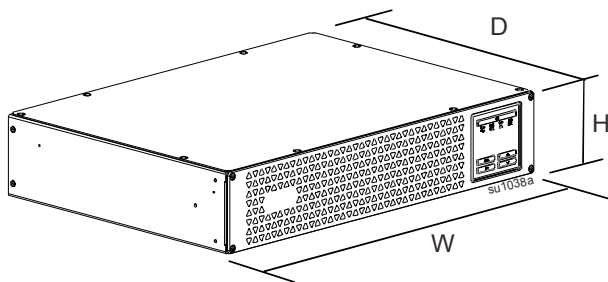

SMTL1500RM3UC Rack-Mount

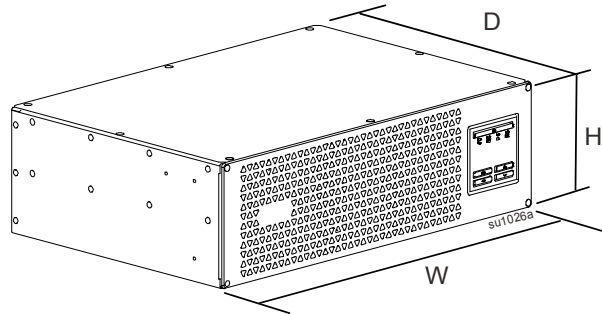

Model	Dimensions (in/mm) H x W x D	Weights (lb / kg)
SMTL750RM2UC	3.4 x 17.25 x 12.52 in (86.35 x 438.15 x 318.1 mm)	34 / 15.4
SMTL1000TM2UC		36 / 16.3
SMTL1500RM3UC	5.14 x 17.25 x 11.89 in (130.6 x 438.15 x 302 mm)	43 / 19.5

Product Overview

SMTL750RM2UC and SMTL1000RM2UC

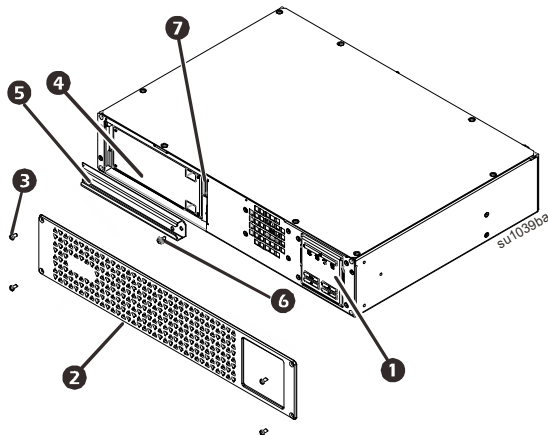

- 1 Display (more information below)
- 2 Bezel
- 3 Bezel Screws
- 4 Battery
- 5 Battery Door
- 6 Battery Door Screw
- 7 Battery Connector

SMTL1500RM3UC Rack-Mount

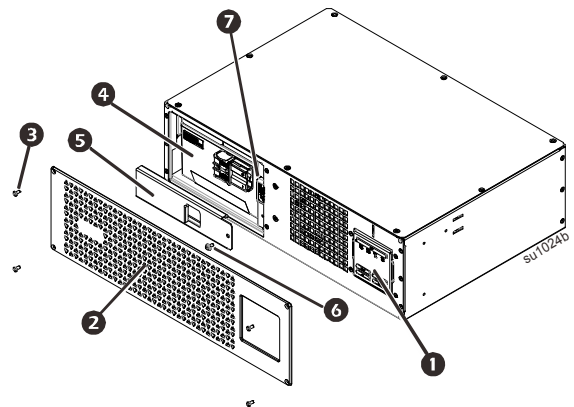

Front panel display features

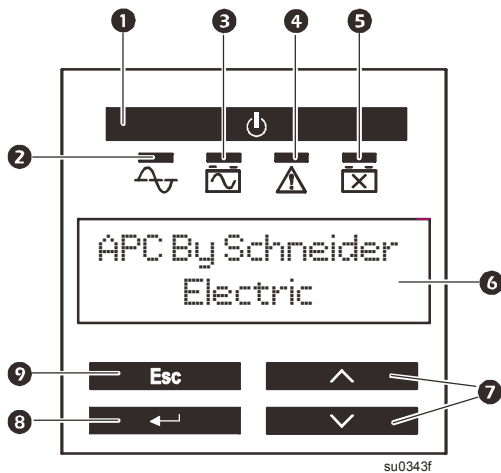

- 1 UPS ON/OFF
- 2 Online LED
- 3 On Battery LED
- 4 Error Detected LED
- 5 Replace Battery LED
- 6 Multi-lingual display screen
- 7 UP/DOWN Selection arrows
- 8 ENTER
- 9 ESCAPE

Rear panel features

- | | | | |
|---|---------------------------------|----|--------------------------------------|
| 1 | APC™ SmartConnect port | 6 | Input circuit breaker |
| 2 | Serial port | 7 | Controlled outlet group |
| 3 | USB port | 8 | Outlets |
| 4 | Chassis ground connection screw | 9 | UPS input power cord |
| 5 | Smart Slot | 10 | Link and data for SmartConnect setup |
| | | 11 | Link to on line users manual |

SMTL750RM2UC and SMTL1000RM2UC

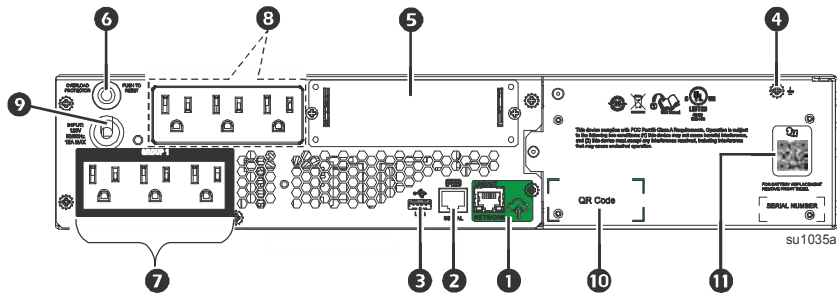

SMTL1500RM3UC

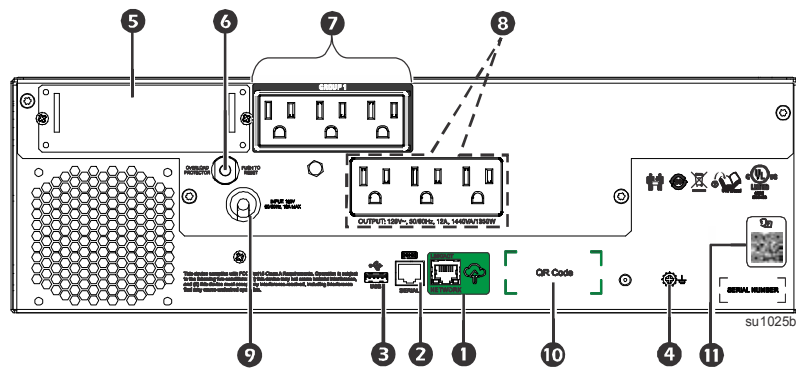

Installation

For UPS installation information, refer to the Installation Guide included with the UPS.

Placement

The UPS is intended for IT environments. Avoid placement where there is excessive dust and humidity. Note that temperature in excess of 25° C may have an adverse effect on battery and UPS life. All vents on the side or rear of the UPS should be free of obstructions.

The UPS is heavy. The UPS should be placed near the bottom of the rack.

Connect to equipment and AC input power

The UPS will charge the battery to 90% capacity in the first three hours of normal operation.

Do not expect full battery runtime capability during this initial charge period.

⚠ CAUTION

RISK OF INJURY OR DAMAGE TO EQUIPMENT

- Adhere to all local and national electrical codes.
- Wiring should be performed by a qualified electrician.
- Always connect the UPS to a grounded outlet.

Failure to follow these instructions can result in injury or equipment damage.

1. Connect the battery. (see Installation Guide)
2. Connect equipment to the outlets in the rear of the UPS. Some models are equipped with controlled outlet groups. Refer to the “Configuration” section of this manual for further instructions on the use of controlled outlet groups.
3. Connect the UPS input to AC power. Once power is connected the display will be active.

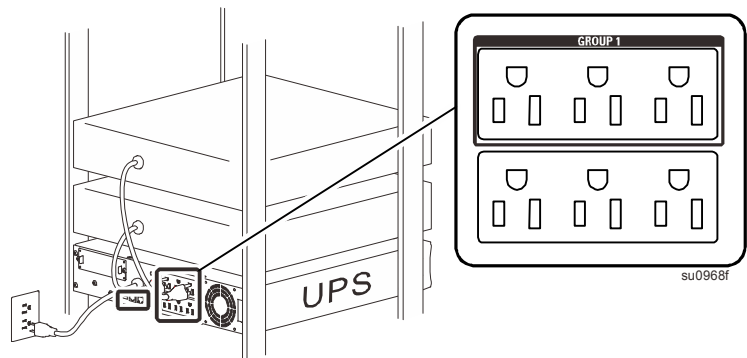

4. Press the main power button  on the UPS display to turn on the UPS output. The On-line LED  will light green when the output is on.

SmartConnect

Connect the APC™ SmartConnect port  to your nearest network switch using the cable provided.



APC SmartConnect allows you to monitor the health and status of your UPS from any device connected to the Internet. Visit www.smartconnect.apc.com to learn more.





Log onto www.smartconnect.apc.com or scan the SmartConnect QR code to launch the registration process. The website includes instructions to setup your online account, activate your warranty and begin monitoring your UPS remotely.

By connecting this product to the Internet using the APC SmartConnect port, you are agreeing to APC SmartConnect Terms of Use, as found at www.smartconnect.apc.com. Schneider Electric Data Privacy Policy can also be found at www.smartconnect.apc.com.

Start up settings

When the UPS is powered on for the first time the LCD screen displays the Setup Wizard and asks a number of basic set-up questions. They can be answered simply by using the arrow   and enter  keys on the display. Configuration can also be performed using PowerChute™ software.

Note: If the start up settings asked by the Setup Wizard are not selected completely, turning on UPS output is inhibited. The Setup Wizard will disappear from the display if the start up settings remain idle for 2 minutes. Pressing the MAIN ON/OFF button on the front panel will relaunch the Setup Wizard and allow completion of the start up settings.

Function	Factory Default	Options	Description
Language	English	English French* German* Spanish* Italian* Portuguese* Japanese*	The language for the display interface. *Language options will vary by model.
Local Power Quality	Good	Good Fair Poor	Select the quality of input AC power. • If Good is selected, the unit will go on battery power more often to provide the cleanest power supply to the connected equipment. • If Poor is selected, the UPS will tolerate more fluctuations in power and will go on battery power less often. If unsure of the local power quality, select Good.
Menu Type	Standard	Standard Advanced	The standard menu displays the most commonly required menus for most users. The advanced menus include all parameters.
Today's Date	Manufacture date		Use   to change the date, and the  to use the date displayed.

Connect and install management software

Smart-UPS is provided with PowerChute management software for unattended operating system shutdown, UPS monitoring, UPS control and energy reporting. The following diagram is a representation of a typical server installation.

1. Connect the USB cable from the rear of the UPS  to the protected device such as a server.

2. For a server or other device with an operating system, load the PowerChute CD and follow the on-screen set-up instructions. PowerChute provides for graceful shutdown in the event of an extended power outage and is a powerful management interface on the local network.

3. A built-in serial port  is also available for additional communication options with an optional serial cable. For more detailed information on supported protocols and options refer to application note #181 at www.apc.com.

4. Even more management options are available via the built-in Smartslot. 

Refer to www.apc.com for more information.

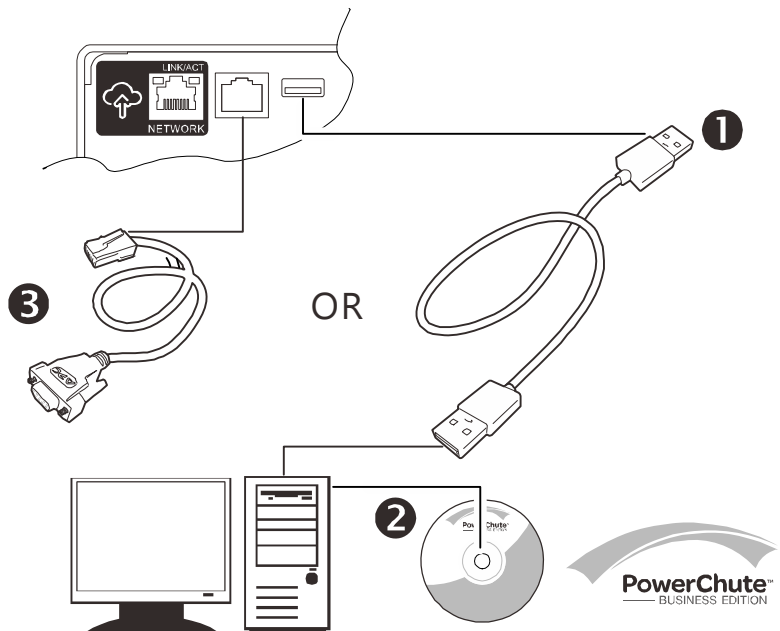









Operation

Using the display

These Smart-UPS models are equipped with an intuitive and configurable LCD display. This display complements the software interface as they convey similar information and either may be used to configure the UPS settings.

The display consists of the following keys and indicators:

Main on/off 	This button is used to turn the UPS output power on and off.
Quick status LEDs    	<p>The online indicator illuminates green when UPS output is turned on and operating on AC power.</p> <p>The on-battery battery indicator illuminates orange and the unit will continue to emit a series of short beeps indicating that the UPS is operating on battery power.</p> <p>The error detected LED will illuminate red if the unit detects an error condition. The display screen may also indicate an error message or code.</p> <p>The replace battery indicator illuminates red when the UPS battery does not pass self test and requires replacement.</p>
Escape 	The escape key always returns the display to the previous screen. It is used to exit the various display menus.
Return 	The return key is used to confirm a selection and/or enter a menu.
Up/down selection arrows 	The arrows are used to navigate through each menu selection.

The display has two status screen/menu options – standard and advanced.

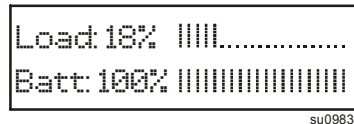

Standard Menu Display
 Default setting with fixed status screen and fewer menus

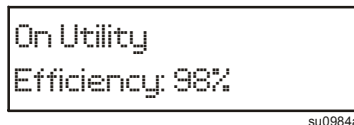

Advanced Menu Display
 Optional setting with automatically scrolling status screen and additional menus

Note: The standard menu is the default setting and does not contain all of the menus and attributes of the advanced menu. The advanced menu automatically scrolls through multiple screens.

Standard menus

The Standard menus are the most commonly used menus. The following is a list of some items displayed in this menu mode.

Menu	General Functions
Status	View UPS information: <ul style="list-style-type: none"> • Operating Mode • Efficiency • Load Power • Load VA • Battery Charge state • Estimated Runtime <ul style="list-style-type: none"> • Battery Temp • Input • Output • SmartConnect • Probe 1, Probe 2, when NMC and sensor probes are installed
Configuration	Configure UPS settings: <ul style="list-style-type: none"> • Language • Green Mode • Local Power Quality: Good, Fair, Poor • Menu Type: Standard or Advanced • Audible Alarm <ul style="list-style-type: none"> • Display (Auto Dim, Auto Off, Always On) • Reset to Factory Default • SmartConnect Control • Install FW?
Test & Diags	Perform UPS tests and diagnostic functions: <ul style="list-style-type: none"> • UPS Self Test • UPS Alarms Test
About	View UPS information: <ul style="list-style-type: none"> • UPS Model • UPS Part No. • UPS Serial No. • UPS Manufacture Date • Battery Part No. • Battery Install Date <ul style="list-style-type: none"> • Replace Battery by • Running UPS FW • Available UPS FW • UPS MAC • UPS IP Address • UPS Product Key • SmartSlot Card (if installed)

Advanced menus

The Advanced menus provide additional options for the UPS and are available only if the display interface is configured to use the Advanced menus.

Menu	General Functions
Status	View detailed UPS information: <ul style="list-style-type: none"> • Operating Mode • Efficiency • Load Power • Load VA • Load Amps • Load Energy • Battery Charge State • Estimated Runtime <ul style="list-style-type: none"> • Battery Voltage • Battery Temp • Input • Output • Outlet Groups • SmartConnect • Probe 1, Probe 2, when NMC and sensor probes are installed
Control	Control the Main and Controlled Outlet Group to turn on, turn off, shutdown, or reboot: <ul style="list-style-type: none"> • UPS Control • Outlet Group Control
Configuration	Configure advanced UPS settings: <ul style="list-style-type: none"> • Language • Green Mode • Local Power Quality • Menu Type • Audible Alarm • Display • Sensitivity • Low Transfer • High Transfer • Auto Self Test • Reset Energy Meter <ul style="list-style-type: none"> • Enter Setup Wizard • Reset to Factory Defaults • Site Wiring Fault • Modbus • Modbus Address • Config Main Group Outlets • Config Group Outlets • ModBus Settings • SmartConnect Control • Install FW? (only available if a firmware update is available) • NMC IP Address Settings (if NMC is available)

Menu	General Functions
Test & Diag	Perform UPS tests and diagnostics functions: <ul style="list-style-type: none"> • UPS Self Test • UPS Alarms Test
Logs	View the error log for information about UPS errors that have occurred.
About	View UPS information: <ul style="list-style-type: none"> • UPS Model • UPS Part No. • UPS Serial No. • UPS Manufacture Date • Battery Part No. • Battery Install Date <ul style="list-style-type: none"> • Replace Battery by • Running UPS FW • Available UPS FW • UPS MAC • UPS IP Address • UPS Product Key • SmartSlot Card (if installed)

Configuration

General configuration settings

Configuration settings may be changed at any time using the LCD interface or PowerChute software. This table provides a brief description of the general settings.

Function	Factory Default	Options	Description
High Transfer	127 Vac	127 Vac - 136 Vac	To avoid unnecessary battery usage, set the transfer point higher if the AC voltage is chronically high and the connected equipment is known to work under this condition. The Power Quality setting will automatically change this setting. Note: Use the Advanced Menus to configure this setting.
Low Transfer	106 Vac	97 Vac - 106 Vac	Set the transfer point lower if the AC voltage is chronically low and the connected equipment can tolerate this condition. This setting may also be adjusted using the power quality setting. Note: Use the Advanced Menus to configure this setting.
Sensitivity	Normal	<ul style="list-style-type: none"> • Normal • Reduced • Low 	Select the level of sensitivity to power events that the UPS will tolerate. <ul style="list-style-type: none"> • Normal: The UPS will go on battery power more often to provide the cleanest power supply to the connected equipment. • Low: The UPS will tolerate more fluctuations in power and will go on battery power less often. If the connected load is sensitive to power disturbances, set the sensitivity to Normal.
Date of Last Battery Replacement	Date set at factory. User will be prompted to update this when the battery module is replaced.		
Display	Auto Off	<ul style="list-style-type: none"> • Auto Off • Auto Dim • Always On 	The UPS can be configured to change the LCD brightness when the interface has not been used for 4 minutes. <ul style="list-style-type: none"> • Auto Off: The LCD turns off. This is used as the default to extend LCD lifetime. • Auto Dim: The LCD switches to a lower brightness. • Always On: The LCD is always at the lower brightness and does not change due to inactivity.
Audible Alarm	On	<ul style="list-style-type: none"> • On • Off 	The UPS will mute all audible alarms if this is set to Off or when the display buttons are pressed while there is an audible alarm.
Auto Self Test	On start-up and every 14 days since the last test	<ul style="list-style-type: none"> • Never • Start-up only • Frequency of test (every 7 to 14 days) 	The interval at which the UPS will execute a self-test.
Reset to Factory Default	No	Yes/No	Restore the UPS factory default settings.
Site Wiring Fault	Enable	Enable/Disable/Can Ack	Set the Site Wiring Fault detection to Enable, Disable or User Can Acknowledge
Green Mode	Enable	<ul style="list-style-type: none"> • Enable • Disable 	This will enable or disable Green Mode function. Green Mode conserves energy while the UPS is operating on line.
SmartConnect Control	Disable	<ul style="list-style-type: none"> • Enable • Disable 	This will permit remote configuration changes.
Install FW?	Don't Install	<ul style="list-style-type: none"> • Next off (Updates the UPS Firmware next time that the UPS is turned off) • Now (Updates the UPS firmware immediately without interrupting operations) • Don't Install 	Firmware update: this only appears when new firmware is available in the flash memory of the UPS and is ready to be installed

Outlet group configuration settings

The Main Outlet Group and the Controlled Outlet Group can be configured to independently turn off, turn on, shut down, or reboot connected equipment.

- Turn off: Disconnect from power immediately and connect only with a manual command.
- Turn on: Connect to power immediately.
- Shutdown: Disconnect from power and automatically connect when AC power becomes available.
- Reboot: Disconnect from power, wait for a specified amount of time, then connect to power.

In addition, the Main Outlet Group and the Controlled Outlet Group can be configured to do the following:

- Turn on or off in a specified sequence.
- Automatically turn off or shut down when various conditions occur.

Note: If the Main and Controlled Outlet Groups are not configured, all of the outlets on the unit will still provide battery back-up power.

Note: The Main Outlet Group must be turned on for the Controlled Outlet Group to turn on.

Function	Factory Default	Options	Description
Name String Outlet Group	Outlet Group 1	Edit these names using an external interface, such as the Network Management Card Web interface.	
UPS Name String	UPS Outlets		
Turn On Delay	0 sec	Set the value in seconds	The amount of time the UPS or the Outlet Group will wait between receiving the command to turn on and the actual startup.
Turn Off Delay	<ul style="list-style-type: none"> • 0 sec (Main Outlet Group) • 90 sec (Controlled Outlet Groups) 	Set the value in seconds	The amount of time the Outlet Group will wait between receiving the command to turn off and the actual shut down.
Reboot Duration	8 sec	Set the value in seconds	The amount of time that the Outlet Group must remain off before it will restart.
Minimum Return Time	0 sec	Set the value in seconds	The amount of battery runtime that must be available before the Outlet Group will turn on.
Load Shed On Battery	Disabled	<ul style="list-style-type: none"> • Shutdown with Delay • Shutdown immediately • Turn off immediately • Turn off with delay • Disabled 	When the unit switches to battery power, the UPS can disconnect power to the Controlled Outlet Group to save runtime. To configure this delay time, use the LOAD SHED TIME WHEN ON BATTERY setting.
Load Shed Time when On Battery	Disabled	Set the value in seconds	The amount of time the UPS will keep the Outlet Group on when operating on battery.
Load Shed On Runtime	Disabled	<ul style="list-style-type: none"> • Shutdown with delay • Shutdown immediately • Turn off immediately • Turn off with delay • Disabled 	When the battery runtime falls below the specified value, the Outlet Group will turn off. Configure this time using the LOAD SHED RUNTIME REMAINING setting.
Load Shed On Runtime Remaining	Disabled	Set the value in seconds	When the remaining runtime reaches this level, the Outlet Group will turn off.
Load Shed on Overload	Disabled	<ul style="list-style-type: none"> • Disabled • Enabled 	In the event of an overload (greater than 100% output power), the Outlet Group will immediately turn off to conserve power for critical loads. The Outlet Group will only turn on again with a manual command.

Modbus settings

Setting	Factory Default	Options	Description
Slave ID	1	1- 223	Sets the Modbus slave address of UPS
Ser+USB	Disable	<ul style="list-style-type: none"> • Enable • Disable 	Enables or disables UPS Modbus protocol over serial and USB ports
TCP Settings <ul style="list-style-type: none"> • TCP Protocols 	Disable	<ul style="list-style-type: none"> • Disable • Read-Only • Read-Write 	<p>Enables or disables UPS Modbus TCP/IP protocol provided by the embedded SmartConnect port.</p> <ul style="list-style-type: none"> • Disable: Disables UPS Modbus TCP/IP protocol • Read-Only: Modbus master over TCP/IP protocol is only allowed to get UPS status. • Read-Write: Modbus master over TCP/IP protocol is allowed to get UPS status and control the UPS. <p>The port number of UPS Modbus TCP/IP protocol is fixed at 502.</p>
TCP Settings <ul style="list-style-type: none"> • Master IP Addr 	000.000.000.000	A valid IPv4 address	<p>Specifies the IPv4 address of the Modbus master.</p> <p>The <i>Master IP Addr</i> when set as 000.000.000.000 will allow connection of external Modbus master with any IP address. When not set as 000.000.000.000, only the Modbus master with the specified IP address is allowed to connect to the UPS.</p> <p>Example: <i>Master IP Address</i> is set to 192.168.0.10, only Modbus master with IP address 192.168.0.10 could connect to the UPS.</p>

UPS IP Address settings

Setting	Factory Default	Options	Description
UPS IP Address Mode	DHCP	<ul style="list-style-type: none"> • DHCP • Manual 	<p>Selects the IP address configuration mode of UPS embedded SmartConnect port:</p> <ul style="list-style-type: none"> • DHCP: UPS will automatically configure its IPv4 address via DHCP protocol. • Manual: Manually assigns a static IPv4 address to UPS
IP Address	000.000.000.000	A valid IPv4 address	<p>This is the IPv4 address assigned to the embedded SmartConnect port.</p> <p>When DHCP IP address mode is selected, it will display the UPS IPv4 address assigned by DHCP server.</p> <p>When Manual IP address mode is selected, you need to manually specify a static IPv4 address.</p>
Subnet Mask	000.000.000.000	A valid IPv4 subnet mask	<p>Assigns the subnet mask of the network where UPS IPv4 address belongs.</p> <p>When DHCP IP address mode is selected, it will display the subnet mask assigned by DHCP server.</p> <p>When Manual IP address mode is selected, you need to manually specify the subnet mask of the network where the specified static IPv4 address belongs.</p>
Default Gateway	000.000.000.000	A valid IPv4 address	<p>This is the IPv4 address of the host from where the UPS sends data to another network or Internet.</p> <p>When DHCP IP address mode is selected, it will display the default gateway assigned by DHCP server.</p> <p>When Manual IP address mode is selected, you need to manually specify the IPv4 address of default gateway.</p>
DNS Server 1	000.000.000.000	A valid IPv4 address	<p>The IPv4 address of first domain name server (DNS) the UPS uses to resolve host names to IPv4 addresses.</p> <p>When DHCP IP address mode is selected, it will display the IPv4 address of the first DNS server assigned by DHCP server.</p> <p>When Manual IP address mode is selected, you need to manually specify the IPv4 address of the first DNS server.</p>
DNS Server 2	000.000.000.000	A valid IPv4 address	<p>The IPv4 address of second domain name server (DNS) the UPS uses to resolve host names to IPv4 addresses (<i>only when UPS fails to resolve IP address through first domain name server</i>). This setting is optional.</p> <p>When DHCP IP address mode is selected, it will display the IPv4 address of the second DNS server assigned by DHCP server.</p> <p>When Manual IP address mode is selected, you can manually specify the IPv4 address of the second DNS server or leave it as 000.000.000.000.</p>

Troubleshooting

Problem and Possible Cause	Solution
The UPS will not turn on or there is no output.	
The unit has not been turned on.	Press the ON key once to turn on the UPS.
The UPS is not connected to AC power.	Be sure the power cable is securely connected to the unit and to the AC power supply.
The input circuit breaker has tripped.	Reduce the load on the UPS. Disconnect nonessential equipment and reset the circuit breaker.
The unit shows very low or no input AC voltage.	Contact a qualified electrician to correct wiring issue.
The battery connector plug is not securely connected.	Be sure that all battery connections are secure.
There is an internal UPS error detected.	Do not attempt to use the UPS. Turn off the UPS and unplug it from AC. Contact APC by Schneider Electric Customer Support for assistance.
If the UPS is not connected to AC Power, then there will be up to a 1-minute delay between the initial connection of the battery and the UPS being ready to start	Wait 1 minute before pressing the ON key, or connect the UPS to AC power to eliminate the delay.
The UPS is operating on battery, while connected to input AC power.	
The input circuit breaker has tripped.	Reduce the load on the UPS. Disconnect nonessential equipment and reset the circuit breaker.
There is very high, very low, or distorted input line voltage.	Move the UPS to a different outlet on a different circuit. Test the input voltage with the AC voltage display. If acceptable to the connected equipment, reduce the UPS sensitivity.
UPS is emitting intermittent beeps.	
The UPS is operating normally.	None. The UPS is protecting the connected equipment.
UPS does not provide expected backup time.	
The UPS battery is weak due to a recent power outage or is near the end of its service life.	Charge the battery. Batteries require recharging after extended outages and wear out faster when put into service often or when operated at elevated temperatures. If the battery is near the end of its service life, consider replacing the battery even if the replace battery indicator has not illuminated.
The UPS is experiencing an overload condition.	Check the UPS load display. Unplug unnecessary equipment, such as printers.
Display interface LEDs flash sequentially.	
The UPS has been shut down remotely through software or an optional accessory card.	None. The UPS will restart automatically when AC power is restored.
The Error LED is illuminated. The UPS displays an error message and emits a constant beeping sound.	
Internal UPS error detected.	Do not attempt to use the UPS. Turn the UPS off and contact APC by Schneider Electric Customer Support immediately.
The Replace Battery icon is illuminated and the UPS beeps for one minute every five hours.	
The battery has a weak charge.	Allow the battery to recharge for at least four hours. Then, perform a self-test. If the problem persists after recharging, replace the battery.
The Replace Battery icon is flashing and the UPS beeps once every 2 seconds.	
The battery is not properly connected.	Be sure that the battery connector is securely connected.
The UPS displays a site wiring error message.	
Wiring errors detected include missing ground, hot-neutral polarity reversal, and overloaded neutral circuit.	If the UPS indicates a site wiring error, have a qualified electrician inspect the building wiring. (Applicable to 120 V units only.)

Limited Factory Warranty

Schneider Electric IT Corporation (SEIT), warrants this product to be free from defects in materials and workmanship for a period of five(5) years from the date of purchase. The SEIT obligation under this warranty is limited to repairing or replacing, at its own sole option, any such defective products. Repair or replacement of a defective product or parts thereof does not extend the original warranty period.

This warranty applies only to the original purchaser who must have properly registered the product within 10 days of purchase. Products may be registered online at warranty.apc.com.

SEIT shall not be liable under the warranty if its testing and examination disclose that the alleged defect in the product does not exist or was caused by end user's or any third person's misuse, negligence, improper installation, testing, operation or use of the product contrary to SEIT's recommendations or specifications. Further, SEIT shall not be liable for defects resulting from: 1) unauthorized attempts to repair or modify the product, 2) incorrect or inadequate electrical voltage or connection, 3) inappropriate on site operation conditions, 4) Acts of God, 5) exposure to the elements, or 6) theft. In no event shall SEIT have any liability under this warranty for any product where the serial number has been altered, defaced, or removed.

EXCEPT AS SET FORTH ABOVE, THERE ARE NO WARRANTIES, EXPRESS OR IMPLIED, BY OPERATION OF LAW OR OTHERWISE, APPLICABLE TO PRODUCTS SOLD, SERVICED OR FURNISHED UNDER THIS AGREEMENT OR IN CONNECTION HEREWITH.

SEIT DISCLAIMS ALL IMPLIED WARRANTIES OF MERCHANTABILITY, SATISFACTION AND FITNESS FOR A PARTICULAR PURPOSE.

SEIT EXPRESS WARRANTIES WILL NOT BE ENLARGED, DIMINISHED, OR AFFECTED BY AND NO OBLIGATION OR LIABILITY WILL ARISE OUT OF, SEIT'S RENDERING OF TECHNICAL OR OTHER ADVICE OR SERVICE IN CONNECTION WITH THE PRODUCTS.

THE FOREGOING WARRANTIES AND REMEDIES ARE EXCLUSIVE AND IN LIEU OF ALL OTHER WARRANTIES AND REMEDIES. THE WARRANTIES SET FORTH ABOVE CONSTITUTE SEIT'S SOLE LIABILITY AND PURCHASER'S EXCLUSIVE REMEDY FOR ANY BREACH OF SUCH WARRANTIES. SEIT WARRANTIES EXTEND ONLY TO ORIGINAL PURCHASER AND ARE NOT EXTENDED TO ANY THIRD PARTIES.

IN NO EVENT SHALL SEIT, ITS OFFICERS, DIRECTORS, AFFILIATES OR EMPLOYEES BE LIABLE FOR ANY FORM OF INDIRECT, SPECIAL, CONSEQUENTIAL OR PUNITIVE DAMAGES, ARISING OUT OF THE USE, SERVICE OR INSTALLATION OF THE PRODUCTS, WHETHER SUCH DAMAGES ARISE IN CONTRACT OR TORT, IRRESPECTIVE OF FAULT, NEGLIGENCE OR STRICT LIABILITY OR WHETHER SEIT HAS BEEN ADVISED IN ADVANCE OF THE POSSIBILITY OF SUCH DAMAGES. SPECIFICALLY, SEIT IS NOT LIABLE FOR ANY COSTS, SUCH AS LOST PROFITS OR REVENUE, WHETHER DIRECT OR INDIRECT, LOSS OF EQUIPMENT, LOSS OF USE OF EQUIPMENT, LOSS OF SOFTWARE, LOSS OF DATA, COSTS OF SUBSTITUANTS, CLAIMS BY THIRD PARTIES, OR OTHERWISE.

NOTHING IN THIS LIMITED WARRANTY SHALL SEEK TO EXCLUDE OR LIMIT SEIT'S LIABILITY FOR DEATH OR PERSONAL INJURY RESULTING FROM ITS NEGLIGENCE OR ITS FRAUDULENT MISREPRESENTATION OF TO THE EXTENT THAT IT CANNOT BE EXCLUDED OR LIMITED BY APPLICABLE LAW.

To obtain service under warranty you must obtain a Returned Material Authorization (RMA) number from customer support. Customers with warranty claims issues may access the SEIT worldwide customer support network through the SEIT Web site: www.apc.com. Select your country from the country selection drop down menu. Open the Support tab at the top of the web page to obtain information for customer support in your region. Products must be returned with transportation charges prepaid and must be accompanied by a brief description of the problem encountered and proof of date and place of purchase.

Transport the Unit

1. Shut down and disconnect all equipment.
2. Disconnect the unit from utility power.
3. Disconnect batteries.
4. Follow the shipping instructions outlined in the *Service* section of this manual.

Service

If the unit requires service, do not return it to the dealer. Follow these steps:

1. Review the *Troubleshooting* section of the manual to eliminate common problems.
2. If the problem persists, visit www.apc.com for APC by Schneider Electric Customer Support contact information.
 - a. Note the model number and serial number and the date of purchase. The model and serial numbers are located on the rear panel of the unit and are available through the LCD interface on select models.
 - b. Call APC by Schneider Electric Customer Support and a technician will attempt to solve the problem over the phone. If this is not possible, the technician will issue a Returned Material Authorization Number (RMA#).
 - c. If the unit is under warranty, it will be repaired or replaced at no cost.
 - d. Service procedures and returns may vary internationally. Refer to the APC web site for country specific instructions.
3. Pack the unit properly to avoid damage in transit. Never use foam beads for packaging. Damage sustained in transit is not covered under warranty.
4. Before shipping, always disconnect all battery modules.
5. Write the RMA# provided by Customer Support on the outside of the package.
6. Return the unit by insured, prepaid carrier to the address provided by Customer Support.

APC by Schneider Electric Worldwide Customer Support

Customer support for this or any other APC by Schneider Electric product is available at no charge in any of the following ways:

- Visit the APC by Schneider Electric web site to access documents in the APC by Schneider Electric Knowledge Base and to submit customer support requests.
 - **www.apc.com** (Corporate Headquarters)
Connect to localized APC by Schneider Electric web sites for specific countries, each of which provides customer support information.
- Contact the APC by Schneider Electric Customer Support Center by telephone or e-mail.
 - Local, country specific centers: go to **www.apc.com/support/contact** for contact information.
 - For information on how to obtain local customer support, contact the APC by Schneider Electric representative or other distributor from whom you purchased your APC by Schneider Electric product.

© 2019 APC by Schneider Electric. APC, the APC logo and APC, the APC logo, Smart-UPS, SmartConnect and PowerChute are owned by Schneider Electric Industries S.A.S. or their affiliated companies. All other trademarks are property of their respective owners.