



Manufactured by:
Backyard Discovery
3305 Airport Drive, Pittsburg, KS 66762
800-856-4445

Basepoint Business Centre: Rivermead Drive, Westlea, Swindon SN5 7EX Phone: 0800-118-2476 J.P. Coenstraat 7, The Bridge, The Hague, 2595 WP, Netherlands Phone: 08005678990

12x10 NORWOOD MOSQUITO MESH KIT MODEL # : 9230231



Please visit www.backyarddiscovery.com
For the most up to date assembly manual, to register your product, or to order
replacement parts *Para obtener instrucciones en español, visite*
www.backyarddiscovery.com

OWNER'S MANUAL - PARTS IDENTIFICATION

HARDWARE COMPONENTS (NOT TO SCALE)



H100392 SCREW PWH BLK
(x208) 8x3/4"

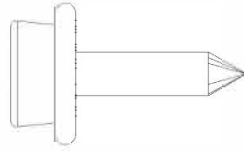

H100254 PHILLIPS HEAD SNAP SCREW
(x4) 8-18x5/8"

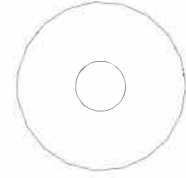

H100478) WASHER BLK
(x8) 8x27

ACCESSORY COMPONENTS (NOT TO SCALE)

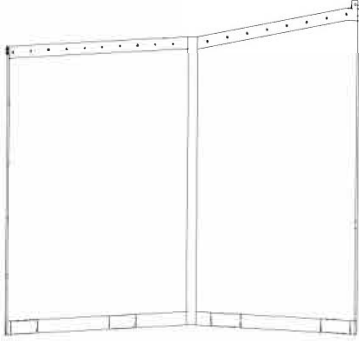

A6P00745 12x10 MESH PANEL
(x2)

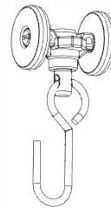

A6P00535 MESH PANEL HOOK
(x60)

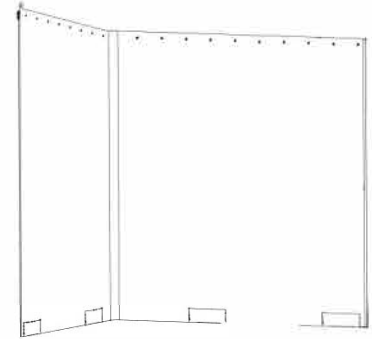

A6P00746 12x10 MESH PANEL
(x2)

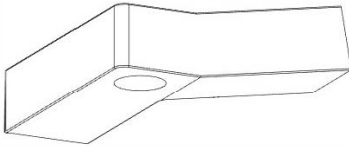

A6P00800 CORNER CAP
(x2)

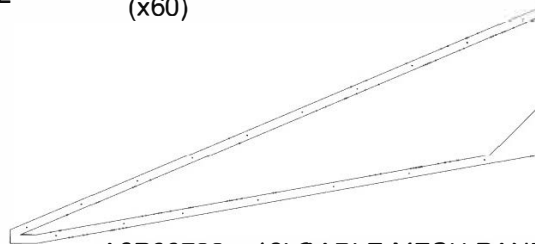

A6P00733 12' GABLE MESH PANEL
(x4)

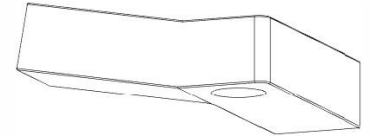

A6P00801 CORNER CAP
(x2)



A6P00998 10FT SOFFIT MESH PANEL
(x2)



A6P00719 MESH PANEL TRACK
(x4)



A6P00804 MESH PANEL TRACK
(x4)



A6P00752 MESH PANEL TIE
(x4)

PRE-ASSEMBLY STEP 1 - SORTING PARTS

It is critical for ease of assembly that you take the time to sort and organize the parts and hardware.

HARDWARE PARTS:

- We recommend that you have a separate table to organize the hardware.
- Hardware bags are printed with a seven-digit, alpha-numeric part number.
- You can organize your hardware by part number or group by hardware type (i.e. bolts, nuts, etc.).
- During assembly you only need to reference the last four digits of the number.

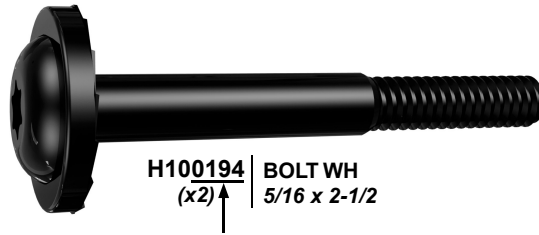

TOOLS REQUIRED:



Cordless Drill or
Electric Drill



Drill Attachments:
Phillips Head



1/8" & 3/8" Drill
Bits



Phillips Screw Driver

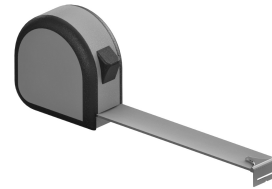

Tape Measure

STEP 1 - TIES

Qty	PartNo	BOM DESCRIPTION
8	H100478	WASHER FLAT 8x27 BLK
8	H100392	SCREW PWH 8x3/4 BLK



A6P00752 MESH PANEL TIE
(x4)

- ATTACH EACH MESH PANEL TIE TO THE POST ASSEMBLY AS SHOWN BELOW.

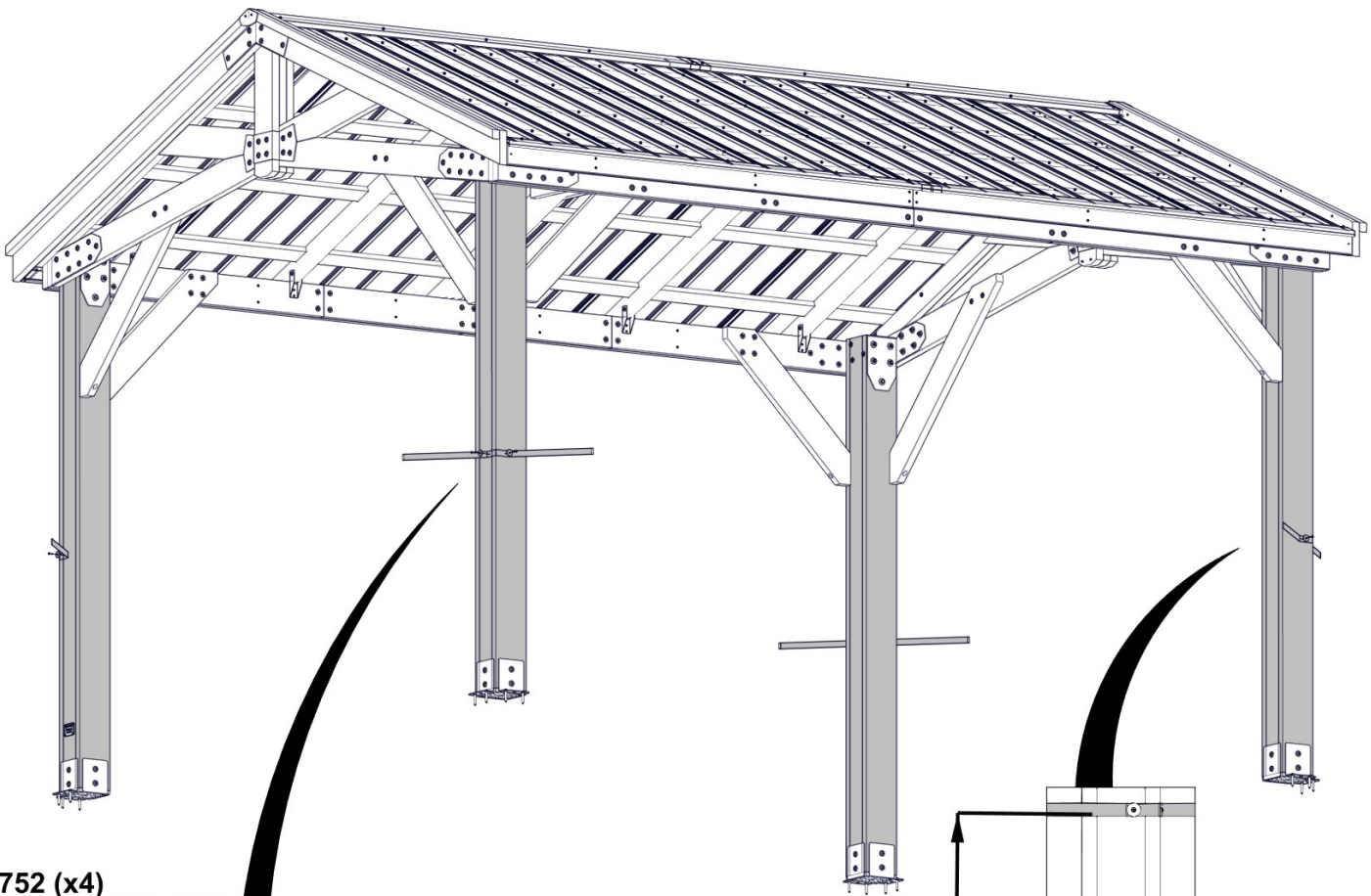

0752 (x4)
MESH PANEL TIE

478 (x8)
WASHER - 8x27

392 (x8)
SCREW - 3/4"

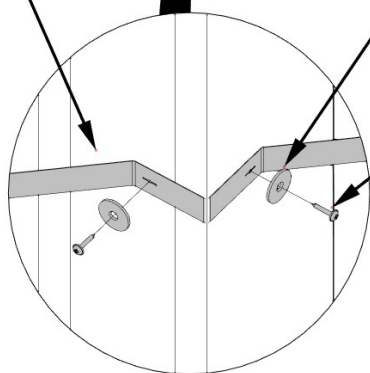

39 3/8"
[1000mm]

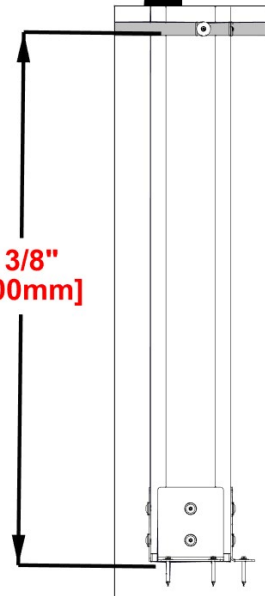

STEP 2 - TRACK ATTACHMENT

Qty	PartNo	BOM DESCRIPTION
32	H100392	SCREW PWH 8x3/4 BLK

A6P00719 MESH PANEL TRACK
(x4)

- ATTACH TRACK TO EACH GABLE
END AS SHOWN BELOW.

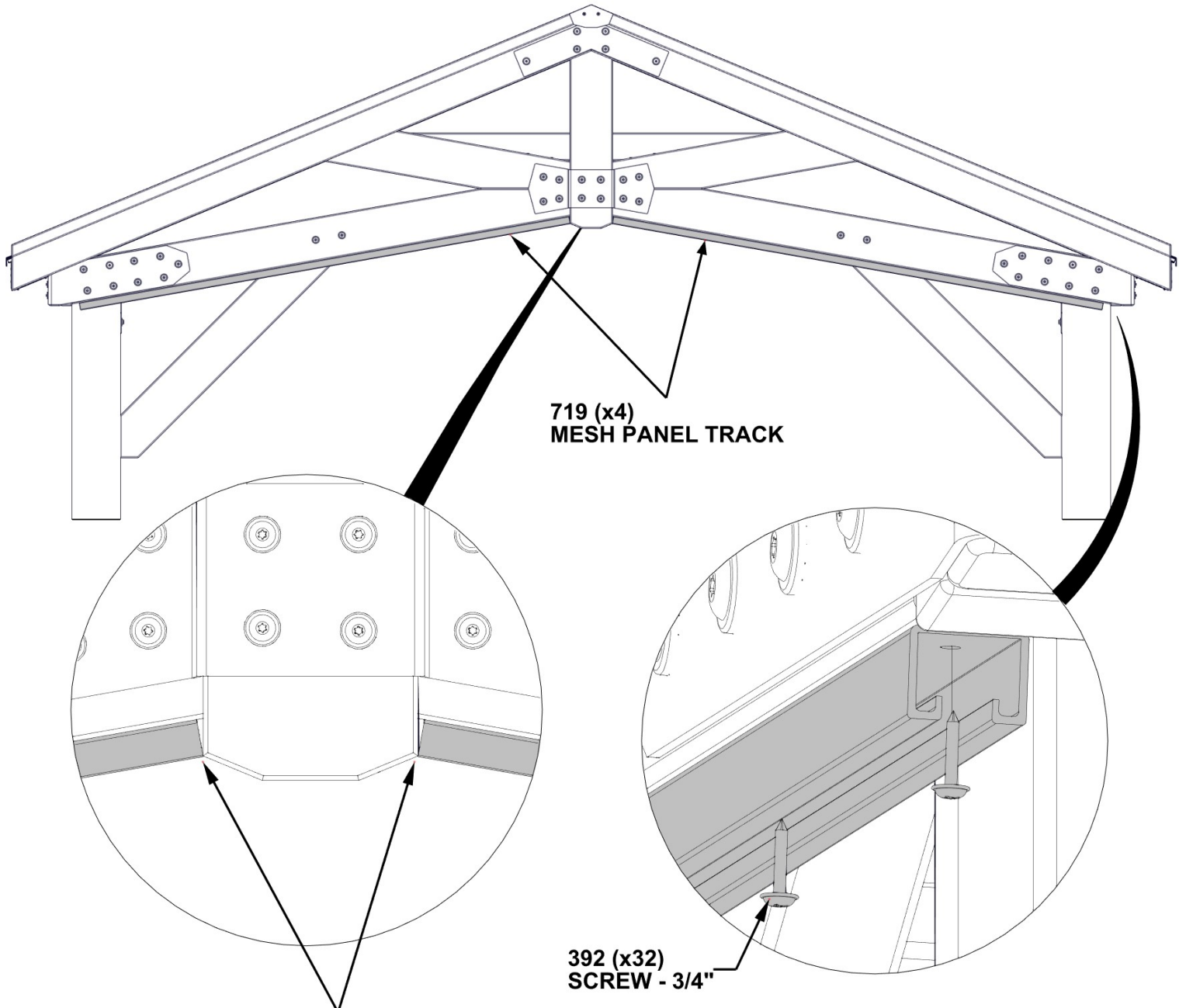

**PUSH BOTTOM EDGE OF TRACK
AGAINST THE GABLE UPRIGHT**

STEP 3 - TRACK ATTACHMENT

Qty	PartNo	BOM DESCRIPTION
28	H100392	SCREW PWH 8x3/4 BLK

A6P00804 MESH PANEL TRACK
(x4)

- START AT THE CENTER OF THE LONG SIDE OF THE GAZEBO AND WORK TOWARD THE GABLE.

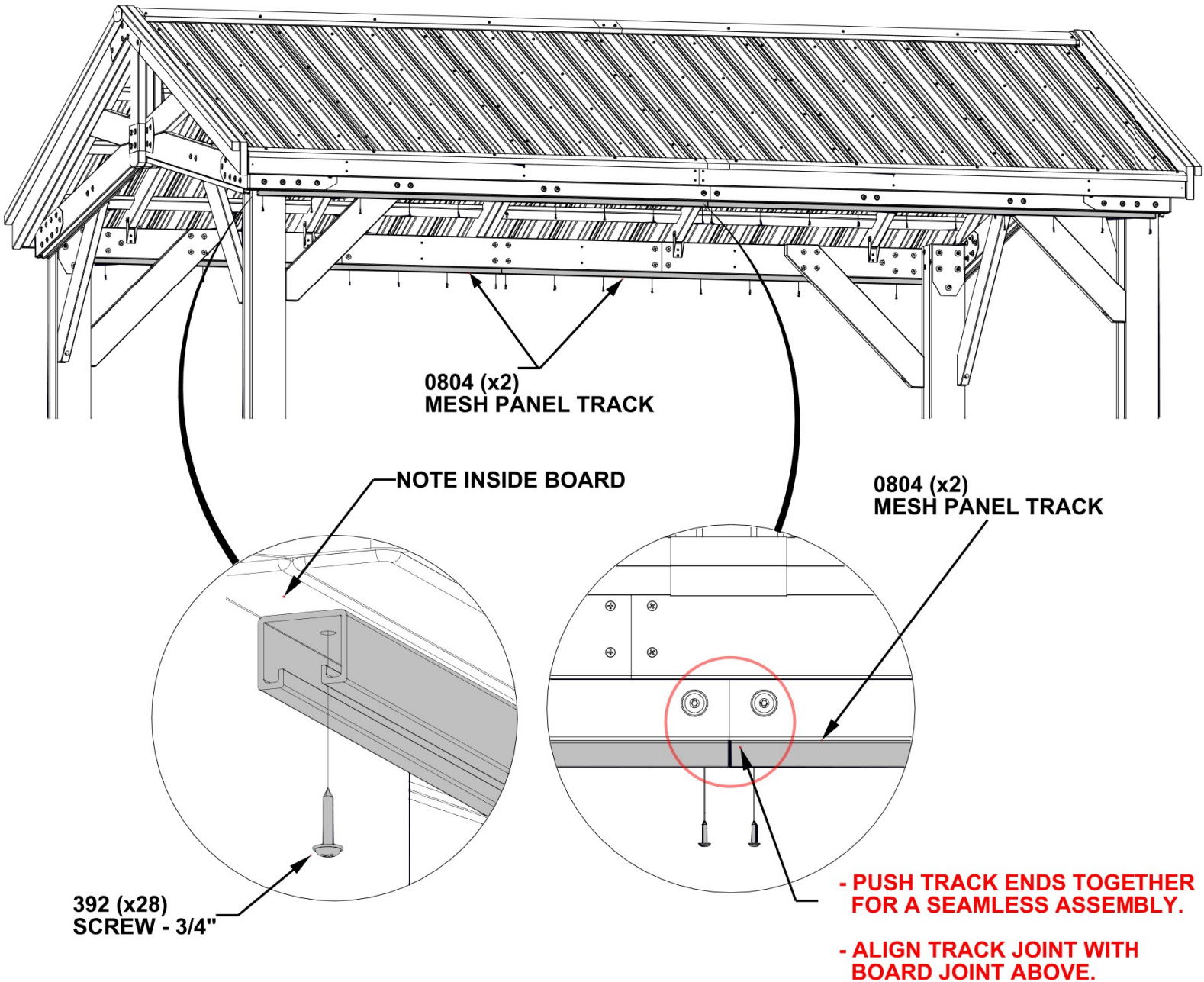

STEP 4 - MESH PANEL HOOK INSTALLATION

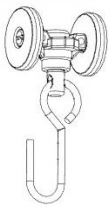

A6P00535 MESH PANEL HOOK
(x28)

- INSERT 14 MESH PANEL HOOKS INTO EACH TRACK ON THE LONG SIDES OF THE GAZEBO .

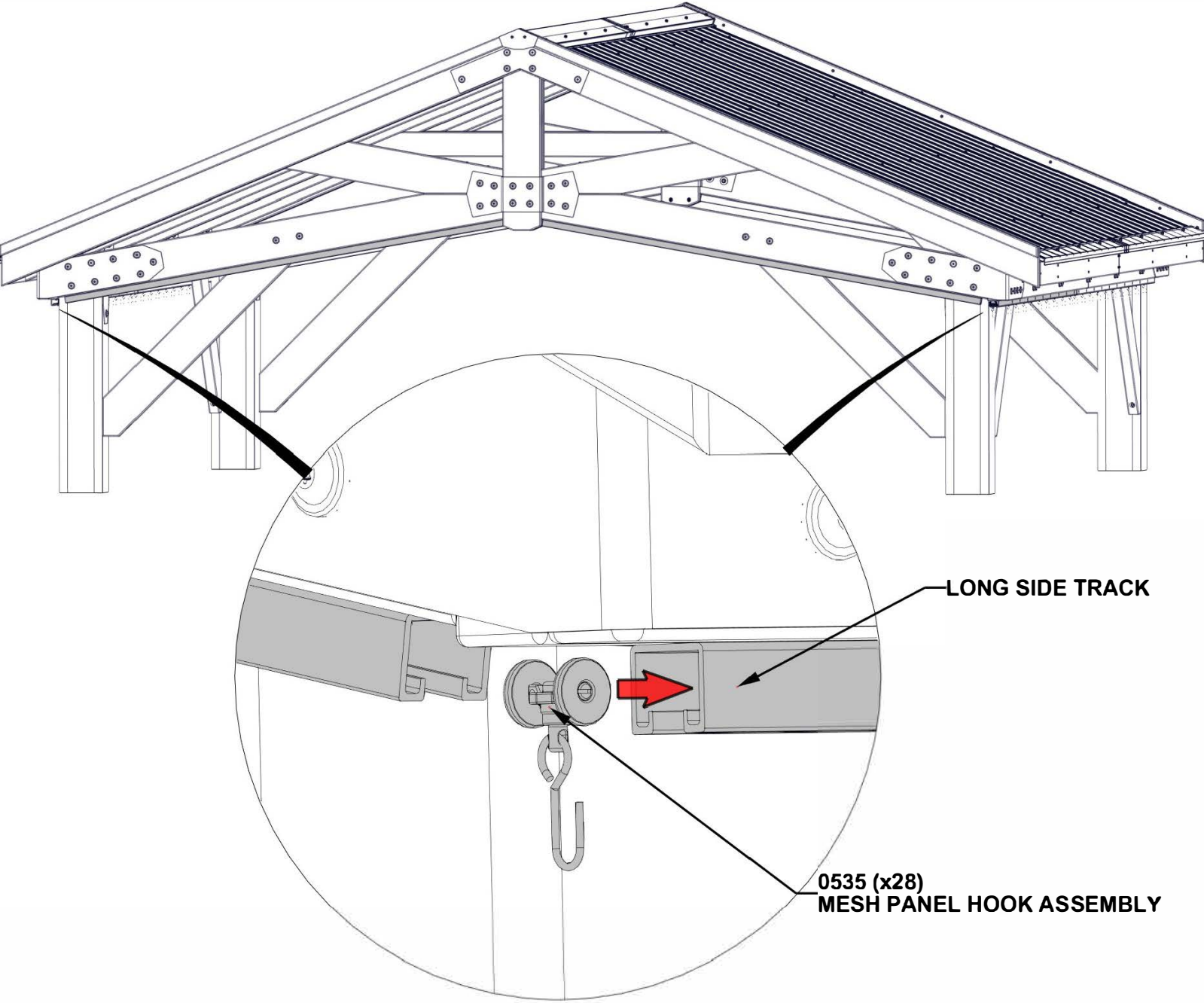

STEP 5A - MESH PANEL HOOK INSTALLATION

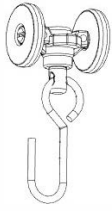

A6P00535 MESH PANEL HOOK
(x32)

- INSERT 8 MESH PANEL HOOKS ON EACH SECTION OF TRACK ON THE GABLE ENDS OF THE GAZEBO
- ONCE THE HOOKS ARE INSERTED INTO THE TRACK, PARTIALLY LOOSEN THE SECOND SCREW FROM THE BOTTOM OF THE GABLE TRACK TO TEMPORARILY HOLD THE MESH PANEL HOOKS IN PLACE UNTIL CORNER CAPS ARE INSTALLED ON NEXT PAGE.

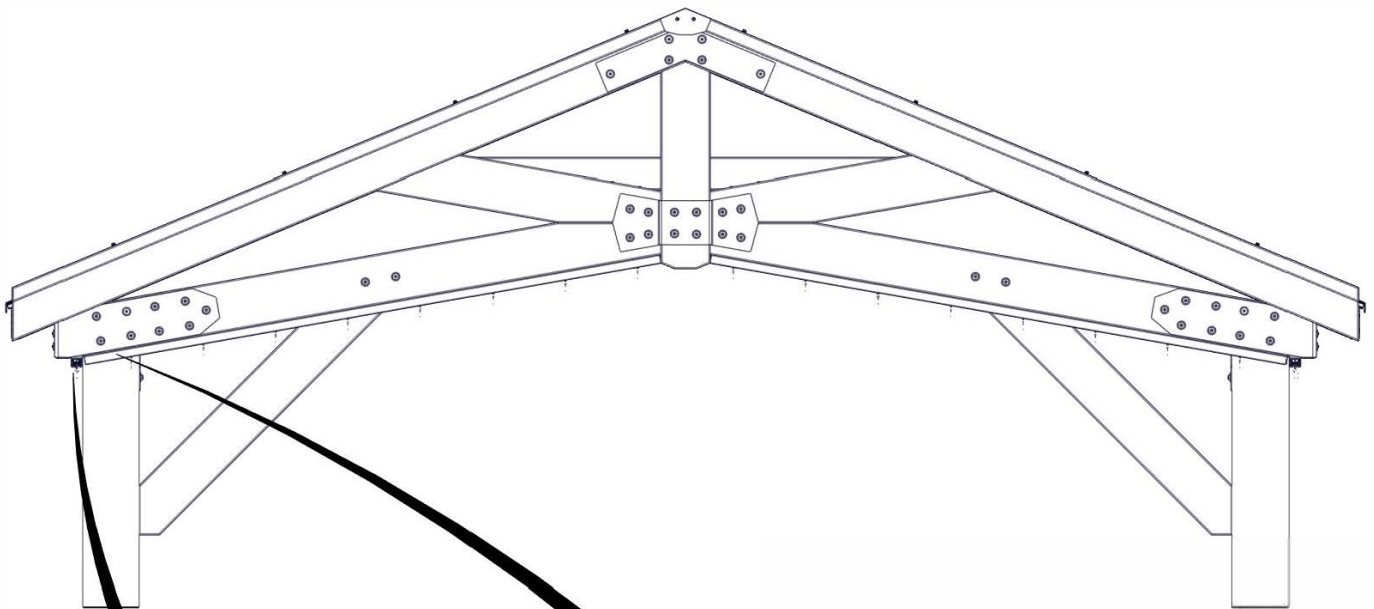

0535 (x32)
MESH PANEL HOOK ASSEMBLY

**PARTIALLY LOOSEN SCREW TO
TEMPORARILY HOLD HOOKS IN
PLACE.**

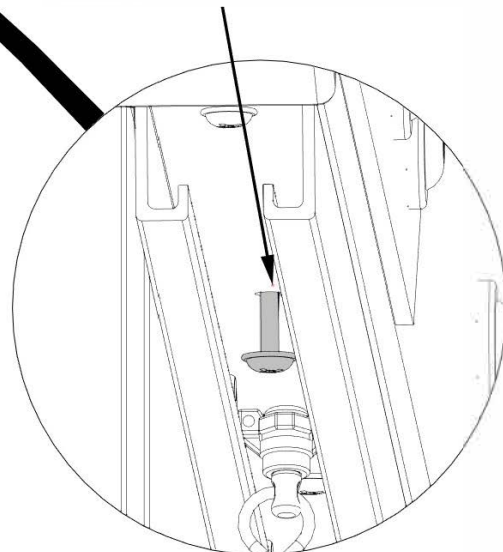
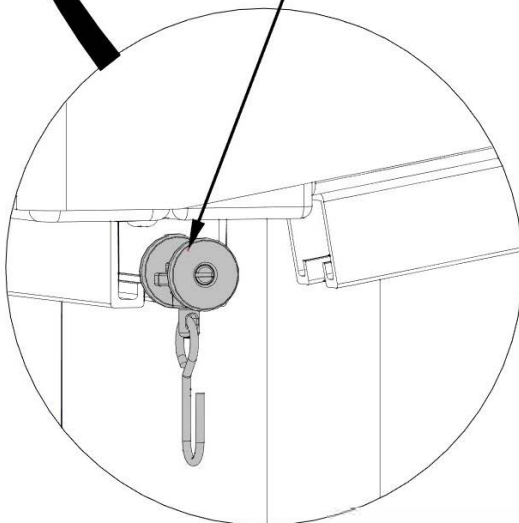

STEP 5B - CORNER CAP INSTALLATION

Qty	PartNo	BOM DESCRIPTION
4	H100392	SCREW PWH 8x3/4 BLK

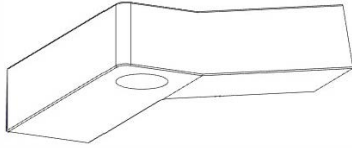

A6P00800 LEFT CORNER CAP
(x2)

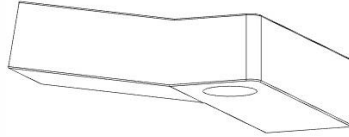

A6P00801 RIGHT CORNER CAP
(x2)

- ATTACH THE CORNER CAPS INTO THEIR DESIGNATED LOCATIONS BY MATCHING THE SLANT.
- TIGHTEN THE SCREWS FROM THE PREVIOUS STEP THAT TEMPORARILY HELD THE HOOKS IN PLACE.

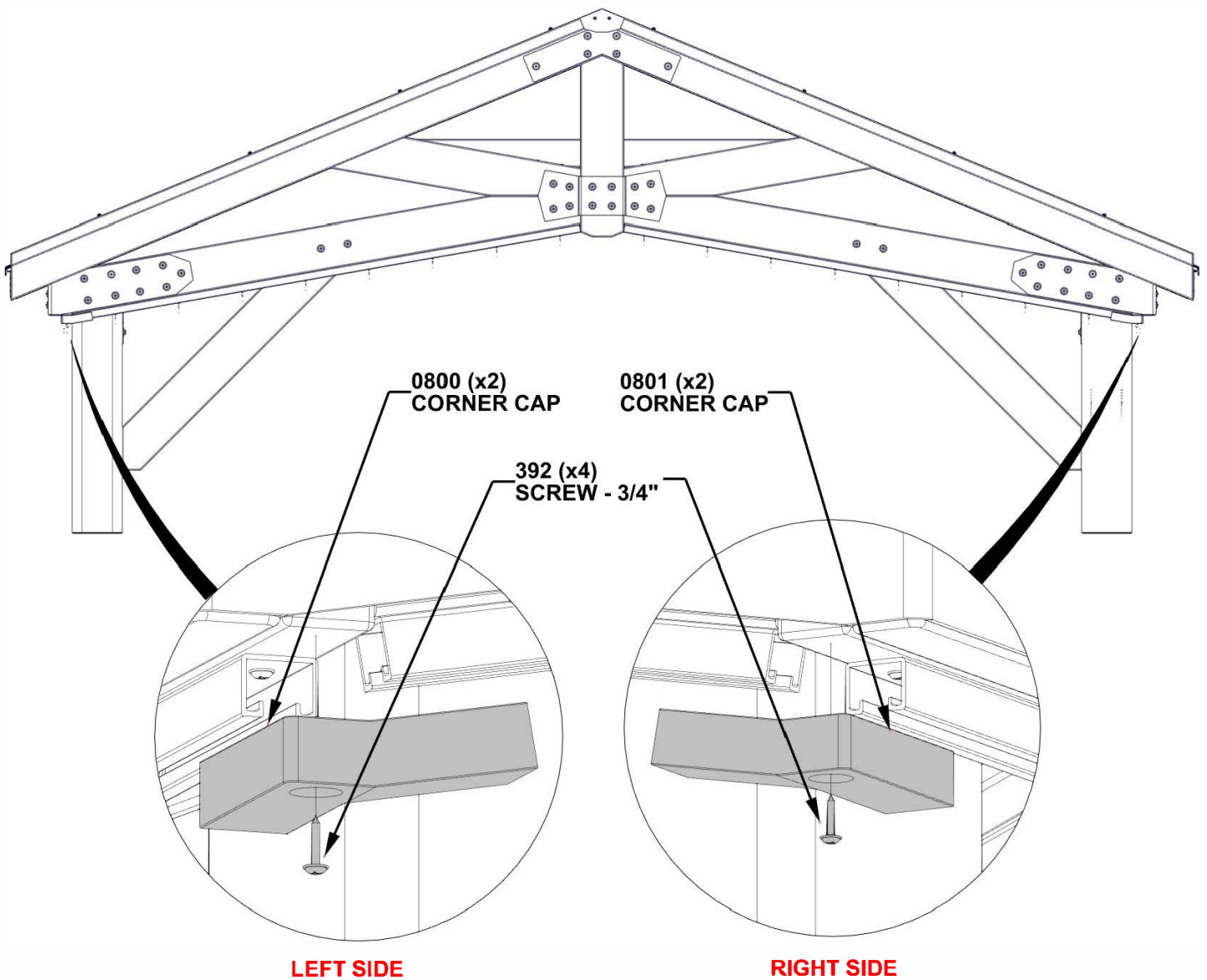

STEP 6 - GABLE MESH ATTACHMENT

Qty	PartNo	BOM DESCRIPTION
88	H100392	SCREW PWH 8x3/4 BLK

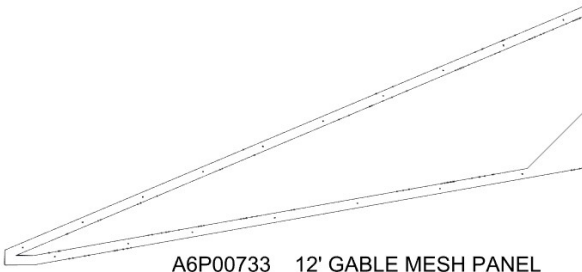

A6P00733 12' GABLE MESH PANEL
(x4)

- ATTACH GABLE MESH PANEL BY ATTACHING THE SCREWS AT THE CENTER OF THE GABLE STRUCTURE FIRST, THEN WORK TOWARD THE BOTTOM CORNER OF THE GABLE.

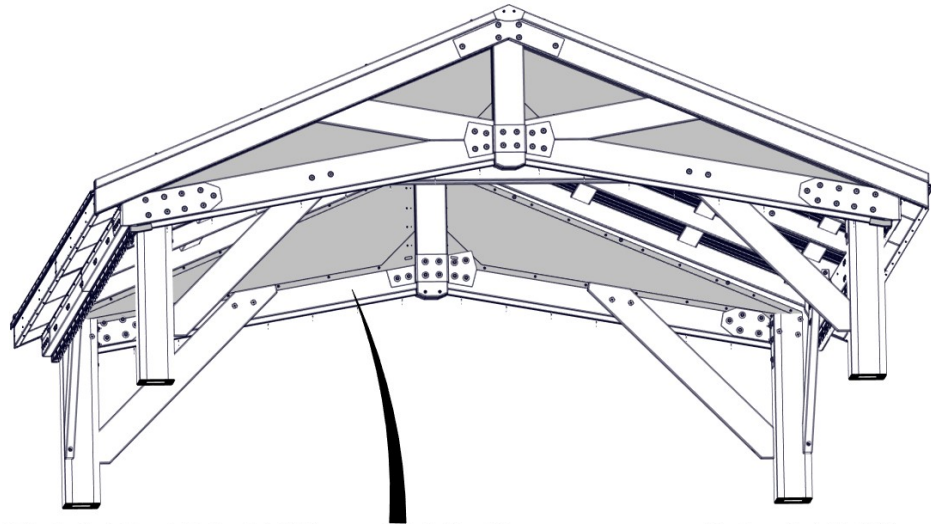

0733 (x4)
12' GABLE MESH PANEL

392 (x88)
SCREW - 3/4"

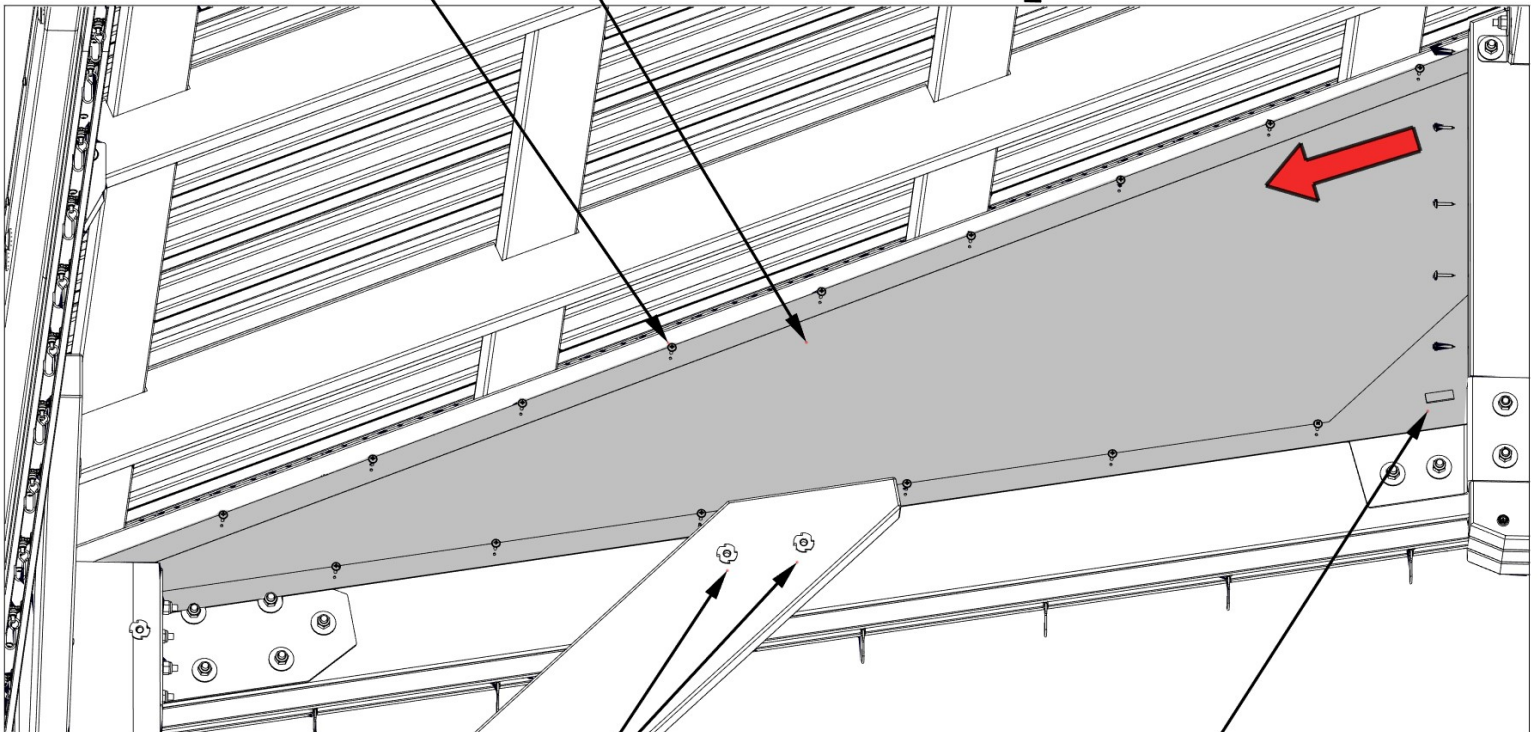

LOOSEN HARDWARE TO ALLOW MESH TO FIT BETWEEN 2 BOARDS ON ALL SIDES.

USE INTEGRATED MAGNET TO HOLD MESH TO BRACKET AS SHOWN

STEP 7 - SOFFIT MESH ATTACHMENT

Qty	PartNo	BOM DESCRIPTION
48	H100392	SCREW PWH 8x3/4 BLK



A6P00998 10FT SOFFIT MESH PANEL
(x2)

- LOCATE THE INTEGRATED MAGNET IN THE EDGE OF THE SOFFIT MESH. THIS IS THE INSIDE EDGE WHICH WILL BE ATTACHED FIRST TO THE FACE OF THE OUTER BEAM.
- THE BOTTOM EDGE OF THE MESH WILL BE 2 7/8" [74mm] ABOVE THE BOTTOM EDGE OF THE OUTER BEAM.
- ALIGN THE OPPOSITE SIDE OF THE SOFFIT MESH WITH THE BOTTOM EDGE OF THE FASCIA BOARD.

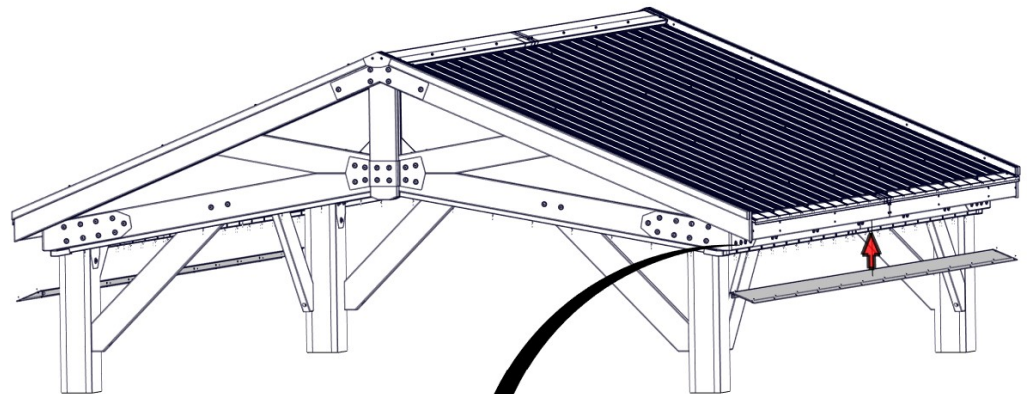

START WITH THIS SCREW

USE INTEGRATED MAGNET TO HOLD MESH TO BRACKET AS SHOWN

NOTE THAT HOLES IN MESH OVER BRACKETS WILL NOT GET A SCREW.

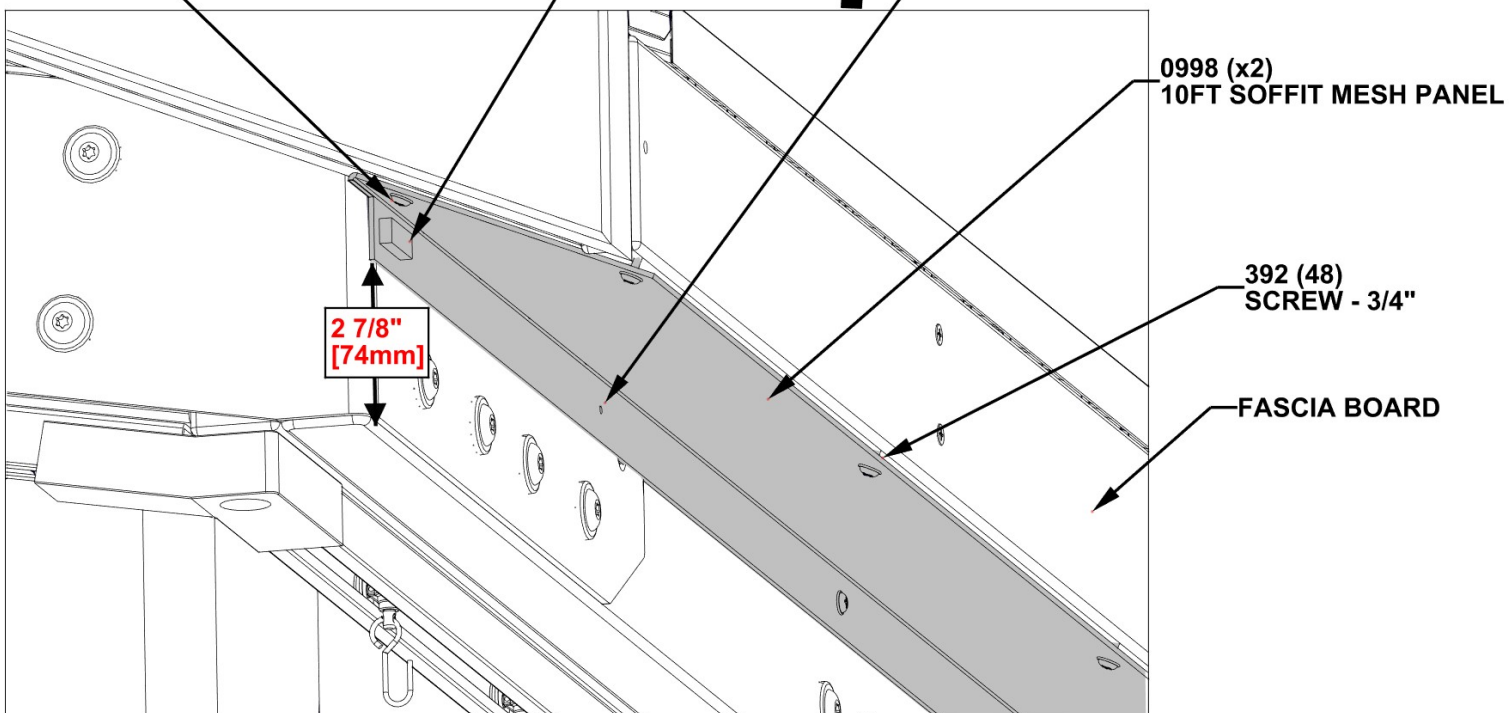

STEP 8 - MESH PANEL INSTALLATION

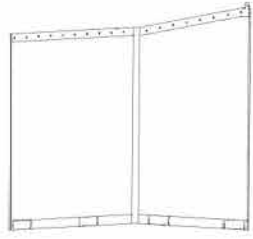

A6P00745 12x10 MESH PANEL
(x2)

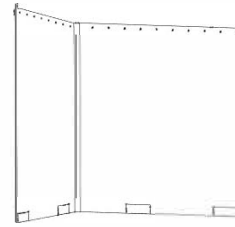

A6P00746 12x10 MESH PANEL
(x2)

1. EACH PANEL GOES AROUND THE OUTSIDE OF THE POSTS AND COVERS ONE HALF OF THE 12FT SIDE AND ONE HALF OF THE 10FT SIDE.
PAY CAREFUL ATTENTION TO THE MESH PANEL PART NUMBERS AS YOU WILL ALTERNATE THEM WHEN HANGING (SEE IMAGE)
2. THE POCKETS AT THE BOTTOM OF THE PANEL SHOULD BE FACING THE INSIDE OF THE GAZEBO.
ZIPPERS WILL NOT ALIGN IF PANELS ARE FACING THE WRONG DIRECTION.
3. BEGIN HANGING MESH PANEL A6P00746 AT THE CENTER OF THE 12FT SIDE (USING 8 HOOKS). CONTINUE AROUND THE POST TO THE 10FT SIDE (USING 7 HOOKS).
4. REPEAT USING THE A6P00745 PANEL ON THE SECOND HALF OF THE 10FT SIDE.
5. REPEAT STEPS 3 & 4.
6. AFTER ALL PANELS ARE HUNG, ZIP THEM TOGETHER.

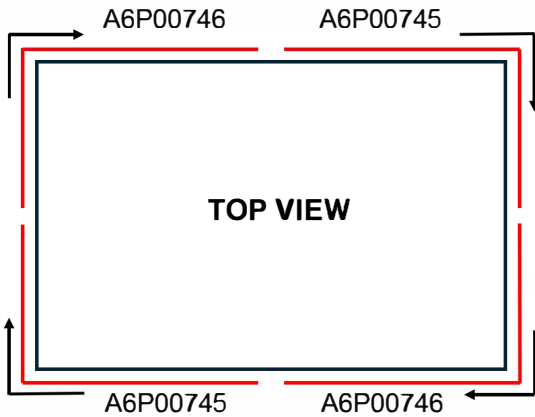

0745 (x2)
12x10 MESH PANEL

ZIPPER PULL

ZIPPER PIN

IT IS RECOMMENDED THAT EACH POCKET IS FILLED WITH WEIGHT

GROMMET

MESH PANEL POCKET

0746 (x2)
12x10 MESH PANEL

STEP 9 - BUTTON SNAP INSTALLATION

Qty	PartNo	BOM DESCRIPTION
4	H100254	PHILLIPS HEAD SNAP SCREW 8-18x5/8"

- INSTALL SNAP SCREWS IN APPROXIMATE LOCATION AS SHOWN.
- USE SNAP SCREW TO ATTACH THE SNAPS FOUND ON TOP OF THE ANGLED SIDE OF THE MESH.
- REPEAT FOR OPPOSITE END OF GAZEBO.

