

FEATURES & SPECIFICATIONS

INTENDED USE — Available in several color temperatures, lumen packages and lengths. Ideal for use in commercial, retail, office, warehouse and display applications. **Certain airborne contaminants can diminish integrity of acrylic and/or polycarbonate.** [Click here for Acrylic-Polycarbonate Compatibility table for suitable uses.](#)

Certain airborne contaminants may adversely affect the functioning of LEDs and other electronic components, depending on various factors such as concentrations of the contaminants, ventilation, and temperature at the end-user location. [Click here for a list of substances that may not be suitable for interaction with LEDs and other electronic components.](#)

CONSTRUCTION — Compact-design channel and cover are formed from code compliant, 22 gauge cold-rolled steel.

SENSOR SWITCH JUST ONE TOUCH TECHNOLOGY — Single room control wireless technology available for easy install and commissioning to aid in code compliance. The JOT option enables the fixture with Just One Touch pairing capability. The JOTVIX15 option features a luminaire-embedded occupancy and ambient light sensor allows the luminaire to power off when the space is unoccupied or when enough ambient light is entering the space.

SENSOR SWITCH VISIBLE LIGHT PROGRAMMING TECHNOLOGY — Standalone sensor programming via VLP mobile app and smart device's camera flash from up to 8ft away.

FINISH — High-gloss, baked white enamel (standard).

OPTICS — LEDs provide 80+ color rendering index (CRI) at 3500K, 4000K and 5000K. Diffuse acrylic lens with ultra-sonically welded end caps provides smooth, linear illumination.

ELECTRICAL — Luminaire Surge Protection Level: Designed to withstand up to 2.5kV/0.75kA per ANSI C82.77-5-2015. For applications requiring higher level of protection additional surge protection must be provided.

Driver is standard 0-10V dimming class 2.

Optional internal pluggable wiring harness for reduced labor cost in row mounting applications. (See PLR_ ordering information on page 5.)

INSTALLATION — Fixture may be surface or suspension mounted with appropriate mounting options (see accessories). Easy to install row aligner bracket included for continuous row mounting.

LISTINGS — CSA certified to US and Canadian safety standards and listed suitable for damp locations. Minimum starting temperature of -40°F (-40°C). Maximum ambient operating temperature of 104°F (40°C) for 4ft models and 95°F (35°C) for 8ft models. See notes for controls temperature restrictions.

DesignLights Consortium® (DLC) qualified product. Not all versions of this product may be DLC qualified. Please check the DLC Qualified Products List at www.designlights.org/QPL to confirm which versions are qualified.

WARRANTY — 5-year limited warranty. This is the only warranty provided and no other statements in this specification sheet create any warranty of any kind. All other express and implied warranties are disclaimed. Complete warranty terms located at: www.acuitybrands.com/support/warranty/terms-and-conditions

Note: Actual performance may differ as a result of end-user environment and application. All values are design or typical values, measured under laboratory conditions at 25 °C. Specifications subject to change without notice.

Catalog Number
Notes
Type

LED Strip Light

CSS



A+ Capable Luminaire

This item is an A+ capable luminaire, which has been designed and tested to provide consistent color appearance and out-of-the-box control compatibility with simple commissioning.

- All configurations of this luminaire meet the Acuity Brands' specification for chromatic consistency
- This luminaire is part of an A+ Certified solution for nLight® or XPoint™ Wireless control networks marked by a **shaded background***

To learn more about A+, visit www.acuitybrands.com/aplus.

*See ordering tree for details

CSS LED Strip Light

CS Looking for Contractor Select readily available configurations? Click here to visit Contractor Select™ spec sheet or go to www.contractorselect.com

ORDERING INFORMATION Lead times will vary depending on options selected. Consult with your sales representative. **Example:** CSS L96 ALO4 MVOLT SWW3 80CRI

Series	Length	Lumen Output	Voltage	Color temperature	Color rendering index
CSS Contractor Single Strip LED	L48 48"	4000LM 4000 Lumens ‡ ALO3 Switchable lumens, 3000LM / 4000LM / 5000LM	MVOLT 120-277V 347 347V ‡	35K 3500K ‡ 40K 4000K ‡ 50K 5000K ‡ SWW3 Switchable white, 35K / 40K / 50K	80CRI 80 CRI
	L96 96"	8000LM 8000 Lumens ‡ ALO4 Switchable lumens, 6000LM / 8000LM / 10000LM			

Options	
Emergency Battery: ‡	VLP Enabled Controls: ‡
IE7WCP Emergency battery pack, 7W, CA Title 20 Noncompliant	VTX15FADC Vertex sensor with Visible Light Programming; On/Off Occupancy with Auto Dimming Photocell (default)
IE10WCPHE Emergency battery pack, 10W, Certified in CA Title 20 MAEDBS	VTX15FANL Vertex sensor with Visible Light Programming; High/Low/(Off) Occupancy Dimming with Auto Dimming Photocell (default)
Plug-in Wiring: ‡	Individual Controls: ‡
PLR___ Plug-in wiring, see page 5 for ordering information	SFR30CSS Factory installed 360°, large motion, high bay sensor, SFR 30
PLR1LVG Plug-in wiring, low voltage dimming	SFR7CSS Factory installed 360°, small motion, low bay sensor, SFR 7 ‡
JOT Enabled Wireless Controls: ‡	Wire Guard (ships separately):
JOT Wireless room control with "Just One Touch" pairing	WG Wire Guard ‡
JOTVTX15 Wireless occupancy sensor with "Just One Touch" pairing	

NOTE: ‡ indicates option chosen has ordering restrictions. Please reference ordering restrictions chart.

Accessories: Order as separate catalog number.	
HC36 M12	Hanger chain, 36" (1 pair)
ZACVH M100	Adjustable 10' aircraft cable with Y hanger (1 pair)
SQ_	Swivel stem hanger (specify length in 2" increments up to 48")
rPP20D	nLight® air dimming/switching module
SFR30CSS	Field installed 360°, large motion, high bay sensor, SFR 30 ‡
SFR7CSS	Field installed 360°, small motion, low bay sensor, SFR 7 ‡
Y J10	Y hanger in multiples of 10 (five pair)
WGCSS	Wire Guard with Mounting hardware (one 4ft)
MNLK JBOXCVR M12	Junction box cover and hardware, white

‡ Option Value Ordering Restrictions	
Option value	Restriction
35K, 40K, 50K	Not available with ALO lumen packages.
4000LM, 8000LM	Not available with SWW3.
Emergency Battery	Not available with 347V or PLR
JOT Enabled Controls	Not available with ALO3, ALO4, 347V or SWW3. Minimum starting temp of 14°F (-10°C). Maximum operating temp of L48 at 95°F (35°C) & L96 at 86°F (30°C). Controls contained in endcap.
VLP Enabled Sensors	Not available with ALO3, ALO4, 347V or SWW3. See page 5 for default programming and coverage pattern information. Sensors contained in endcap.
SFR Sensors	Not available with 347V. Can only be mounted at the end of continuous row mount applications. On/off function only. Minimum starting temp of 14°F (-10°C). Sensors mount to end of fixture.
Wire Guard	Does not cover SFR controls. Not recommended for use with endcap integrated JOT or VLP enabled controls due to potential detection obstruction.
PLR___ & PLR1LVG	Not available with Emergency or Controls

ACCESSORY BATTERY PACKS - SUITABLE FOR FIELD INSTALLATION

are ***Remote mount outside the fixture.***

Battery Part Number	CA Title 20	Self Diagnostics
ILB CP10 A	No	No
ILB CP10 HE A	Yes	No
ILBLP CP10 HE SD A	Yes	Yes
LEM04 A	Yes	No
LEM08 A	Yes	No

How to Estimate Delivered Lumens in Emergency Mode
 Use the formula below to estimate the delivered lumens in emergency mode
Delivered Lumens = 1.25 x P x LPW
 P = Output power of emergency driver. P = 10W for IE10WCPHE
 LPW = Lumen per watt rating of the luminaire. This information is available on the ABL luminaire spec sheet.
 The LPW rating is also available at Designlight Consortium.

OPERATIONAL DATA

Length	Nominal Lumen Package	Color Temperature	Delivered Lumens	Wattage	Lumens/Watt	
L48	4000 LM	4000K	4,298	35.3	121.8	
	ALO3 (3000 LM)	3500K	3,190	27.7	115.4	
		4000K	3,247	27.7	117.4	
		5000K	3,250	27.7	117.5	
	ALO3 (4000 LM)	3500K	4,135	35.8	115.4	
		4000K	4,206	35.8	117.3	
		5000K	4,268	35.8	119	
	ALO3 (5000 LM)	3500K	5,058	43.9	115.1	
		4000K	5,150	43.9	117.2	
		5000K	5,274	43.9	120.1	
	L96	8000 LM	4000K	8,596	72	119.3
		ALO4 (6000 LM)	3500K	6,380	55.3	115.4
4000K			6,495	55.3	117.4	
5000K			6,501	55.3	117.5	
ALO4 (8000 LM)		3500K	8,271	71.7	115.4	
		4000K	8,413	71.7	117.3	
		5000K	8,535	71.7	119	
ALO4 (10000 LM)		3500K	10,115	87.9	115.1	
		4000K	10,300	87.9	117.2	
		5000K	10,549	87.9	120.1	

Note: All values are typical and are at 25C. Actual performance may vary and is dependent on operating environment.

PROJECTED LUMEN MAINTENANCE			
Lumen Maintenance Factor	0.91	0.81	0.75
Operating Hours	40,000	90,000	120,000

Note: Actual performance may vary based on ambient temperature of installed location.

DIMENSIONS

All dimensions are shown in inches unless otherwise noted.

Length	Width	Height	Approximate weight	Fixtures per pallet	Pallet Dimensions
L48	2.62	2.22	5 lbs	98	46 x 57
L96	2.62	2.22	10 lbs	102	46 x 98.5

*Weights will vary slightly with added options.

4FT Assembly

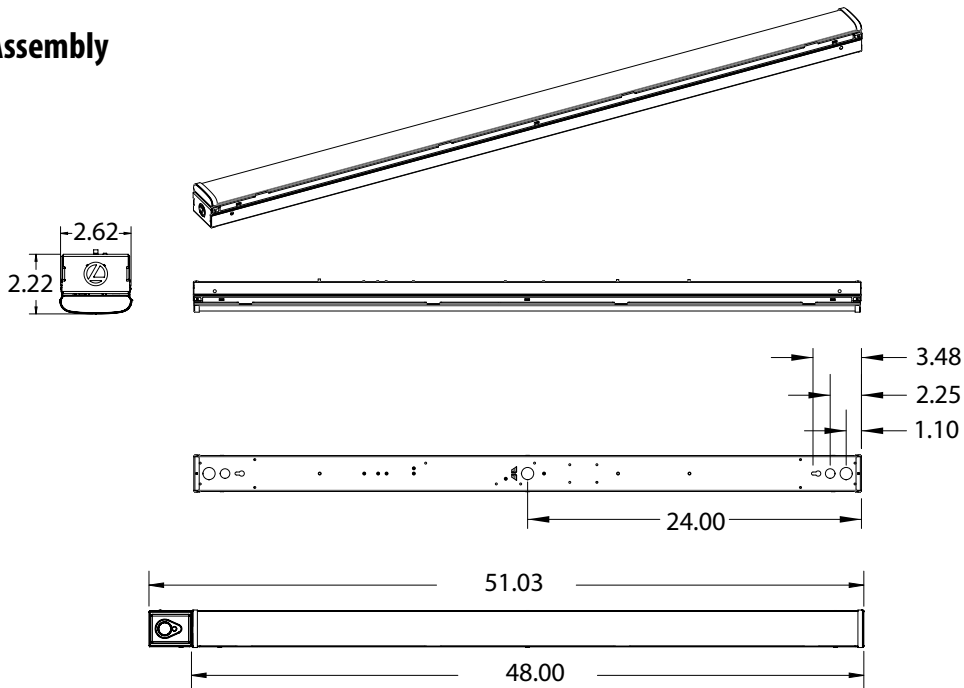

8FT Assembly

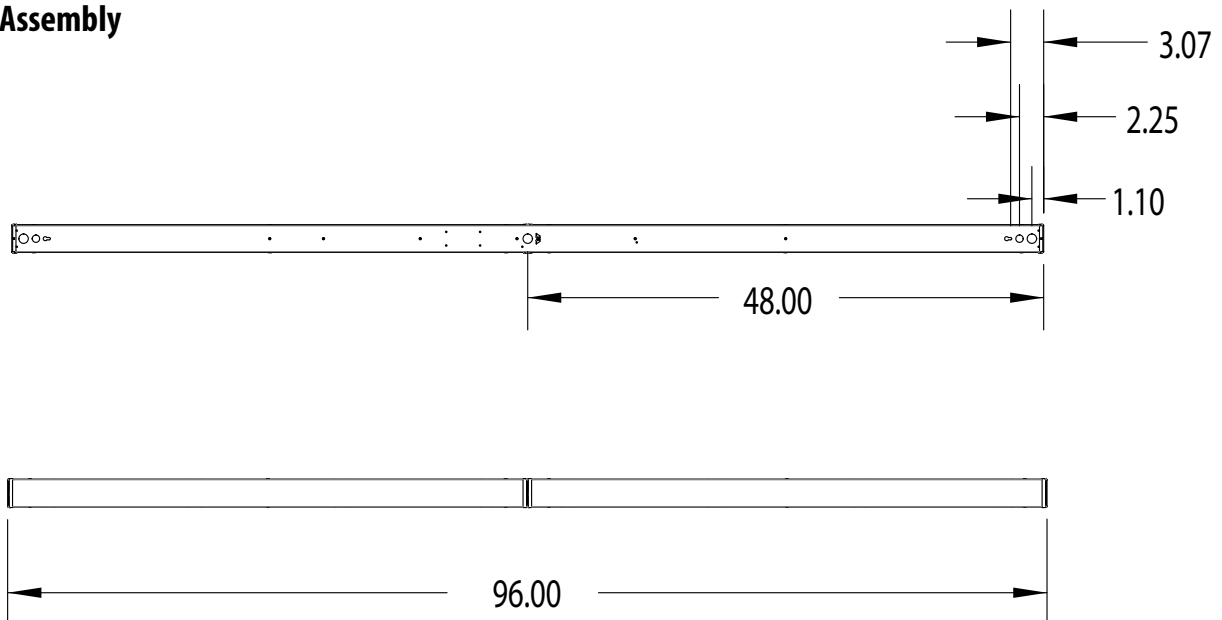

PLUG-IN WIRING OPTION

Advanced plug-in system with two-circuit capability. Available on industrial and strip products and a variety of architectural products mounted in continuous rows. PLR22 (2-circuit) and crossover harness switches hot circuit serving next fixture in row. Reduces fixture turns on job for alternating circuit applications (see example below.)

Easy one-step installation, saves up to 35% on labor costs. Expanded switching flexibility helps save energy.

Rows can be 50% longer with two-circuit systems. Polarized, lock-together nylon connectors prevent miswiring in the field. #12 THHN conductor, rated 600V, 90°C. White neutral wire included. Grounding accomplished by fixture in-row connectors.

CSA certified systems available with up to 2 circuits. G ground required.

Not for use with dedicated emergency circuits.

Note: Specifications subject to change without notice.



PLR

Advanced 1 or 2-Circuit Plug-In

ORDERING INFORMATION

Lead times will vary depending on options selected. Consult with your sales representative.

Series	Number of hot wires		Branch circuits	Dimming	Ground
PLR	(blank)	Not required for PLR22	<u>Circuits to which driver is connected</u>	LV Low-voltage dimming	G Ground (required)
PLR22	1	Black	(blank) Not required for PLR22		
	2	Black and red	A Black wire B Red wire		

Typical Applications

- Multiple-circuit and single-circuit for longer continuous rows
- Multiple-circuit with alternating fixtures on separate circuits and 2-circuit (PLR22)
- Multiple circuit with night-lights located along row as desired

JOT ENABLED WIRELESS CONTROLS

TYPICAL SMALL ROOM APPLICATION (UP TO 250 SQ. FT.)

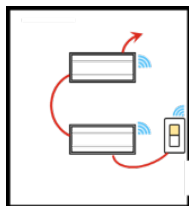

One Entryway
1x WSXA JOT
2x JOT Enabled Fixture

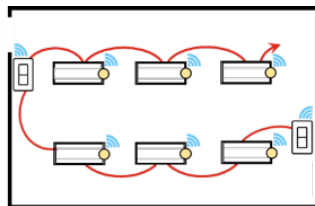

Two Entryways
2x SPODMRA JOT
6x JOT Enabled Fixture with Occupancy Sensor

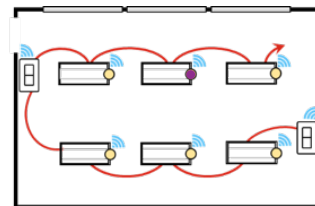

Two Entryways with Daylight Harvesting
2x SPODMRA JOT
1x JOT Enabled Fixture with Photocell and Occupancy Sensor
5x JOT Enabled Fixture with Occupancy Sensor



JOT

For use with
Sensor Switch
WSXA JOT
Dimming Wall
Switch Sensor

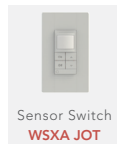

Sensor Switch
WSXA JOT



JOTVTX15

For use with
Sensor Switch
SPODMRA JOT
Dimming Wall
Switch

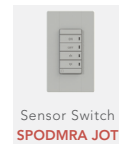

Sensor Switch
SPODMRA JOT

Option	Default Firmware					
	OCC Time Delay	Dim to Off Time Delay	Photocell Mode	Photocell Setpoint	Low Trim	High Trim
VTX15FADC or JOTVTX15	10 Min	N/A	On/Off & Auto Dimming	50FC	10%	100%
VTX15FANL		Stay At Dim (Never Off)				
SFR7CSS or SFR30CSS		N/A				

VTX & JOTVTX SENSOR COVERAGE PATTERNS

15F LARGE MOTION EXTENDED RANGE 360°

- Optimized full coverage from 8 ft - 15 ft (2.4 m - 4.5 m) mounting heights
- Reliable detection of large motion (e.g. pedestrian walking traffic)
- 1.3 x's mounting height equals approximate detection range



TOP VIEW

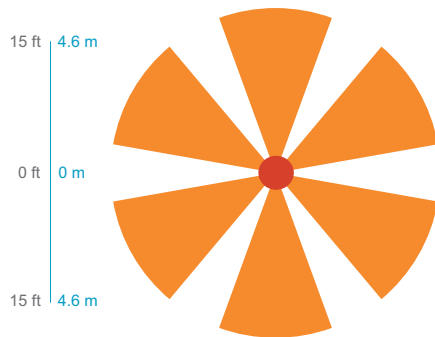

SIDE VIEW

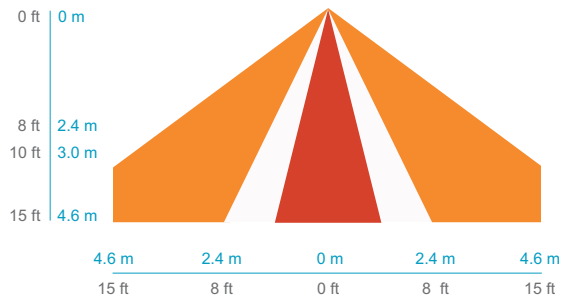

SFR SENSOR COVERAGE PATTERNS

SFR 30 UNIVERSAL 360°

- Provides excellent detection of large motion (e.g. walking) when mounted between 15 to 40 ft (4.57 to 12.19 m)
- 15 to 20 ft (4.57 to 6.10 m) radial coverage overlaps area lit by a typical high bay fixture
- Recommended for fixtures that have a 1:1 spacing to mounting height ratio or less (e.g. fixtures 30' on center or less @ a 30' mounting height).



SIDE VIEW

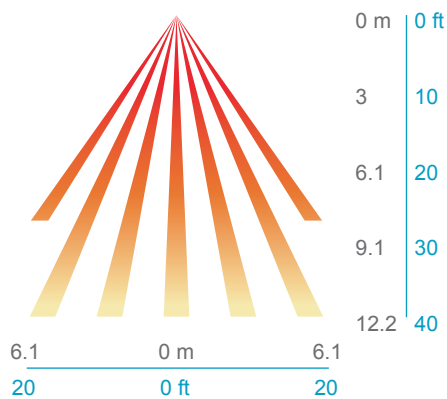

TOP VIEW

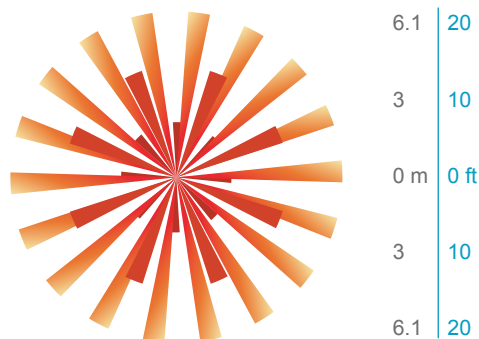

SFR 7 MINI LOW BAY 360°

- Recommended for walking motion detection from mounting heights between 8 ft (2.44 m) and 20 ft (6.10 m)
- Initial detection of walking motion along sensor axes at distances of 2x the mounting height up to 15 ft (4.57 m) and 1.75x up to 20 ft (6.10 m).
- Provides 12 ft (3.66 m) radial detection of small motion when mounted at 9 ft (2.74 m)
- Initial detection will occur earlier when walking across sensor's field of view than when walking directly at sensor

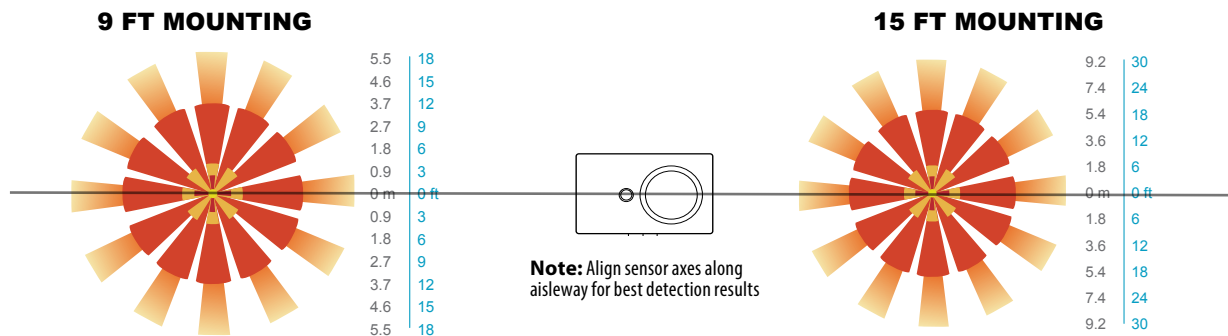

MAXIMUM # OF FIXTURES PER SFR SENSOR

Nomenclature	Maximum # of Fixtures per SFR SENSOR
CSS L48 4000LM MVOLT	20
CSS L48 ALO3 MVOLT	16
CSS L96 8000LM MVOLT	10
CSS L96 ALO4 MVOLT	8

PHOTOMETRICS

Please see www.lithonia.com.