

Name _____

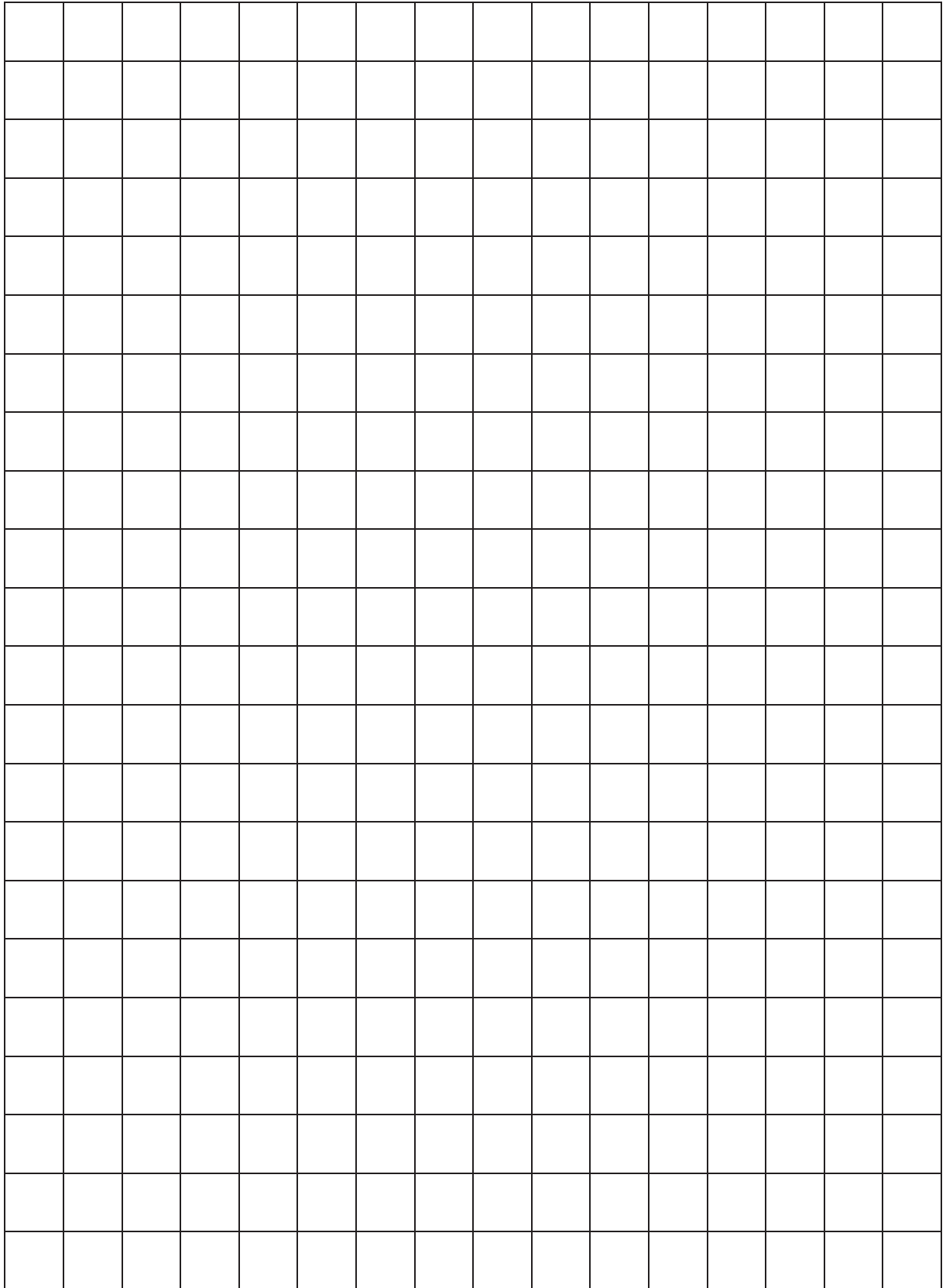

Name _____

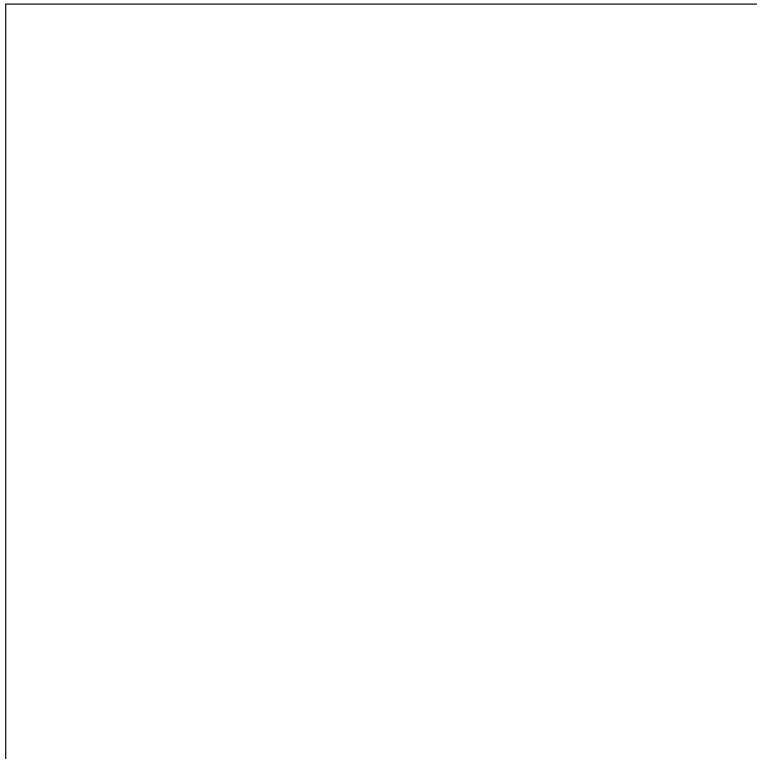
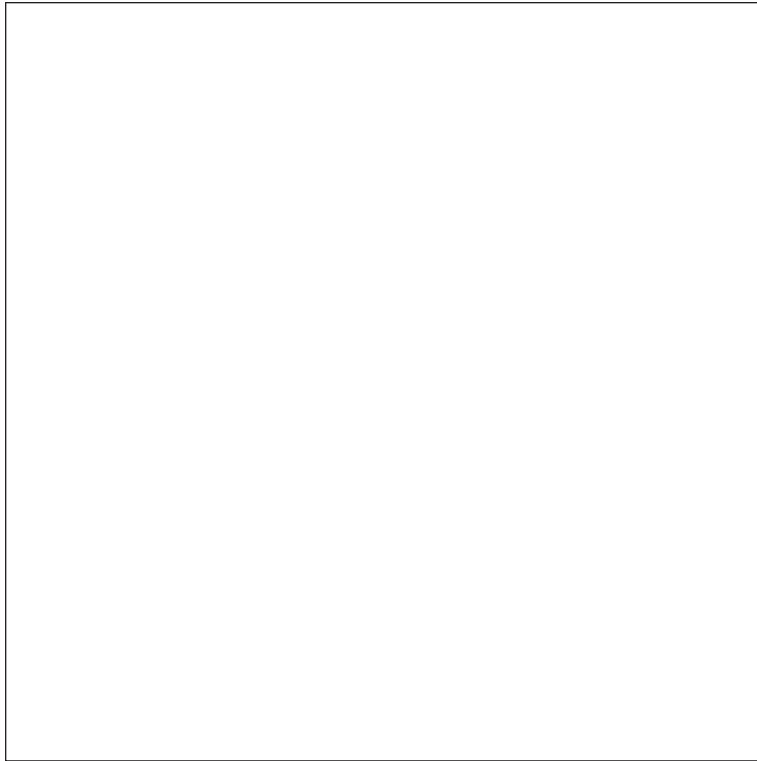

Name _____

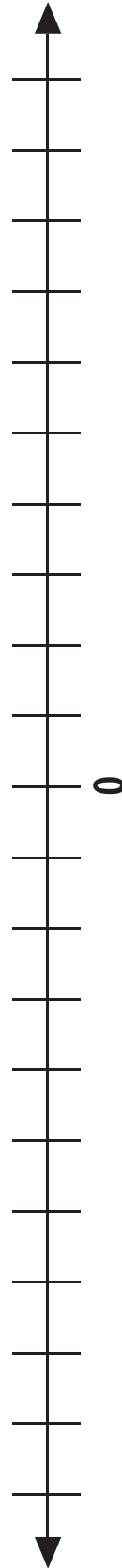
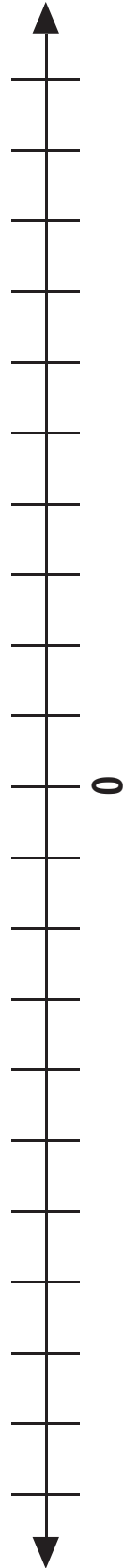
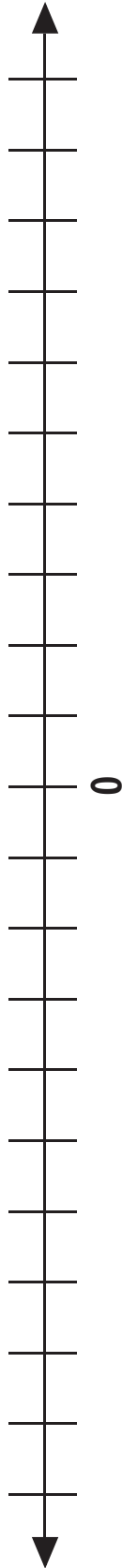

Name _____

BLM

4

Algeblocks® Basic Mat

The image shows a large rectangular mat divided into two horizontal sections. The top section is white and contains a large plus sign (+) in the upper right corner. The bottom section is shaded gray and contains a small minus sign (-) in the lower right corner.

Name _____

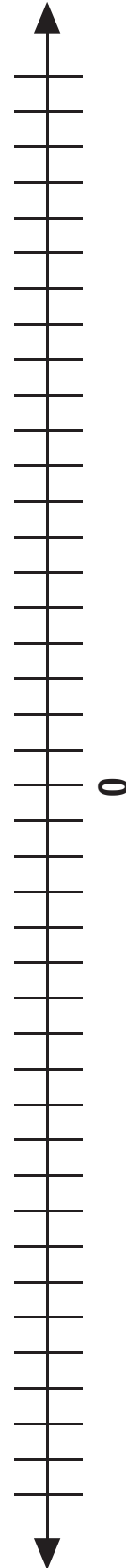
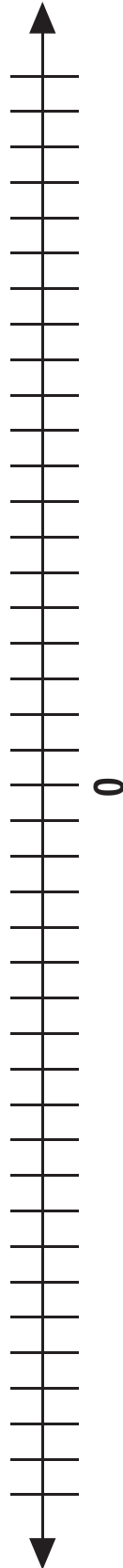
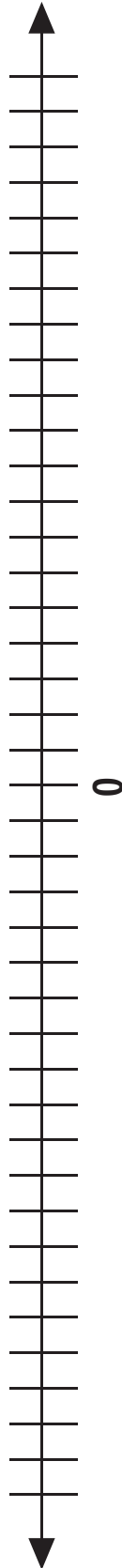

Name _____

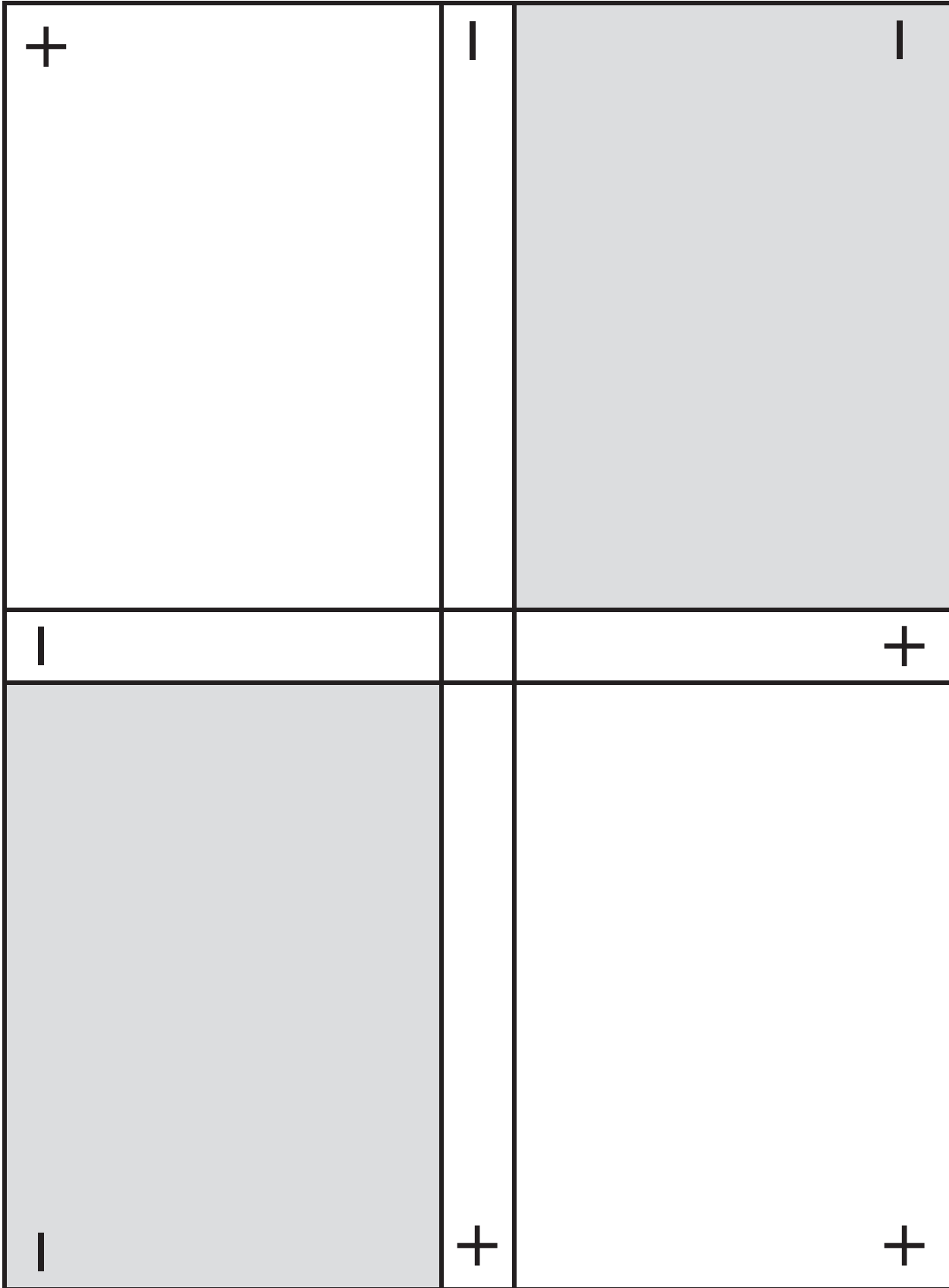

Name _____

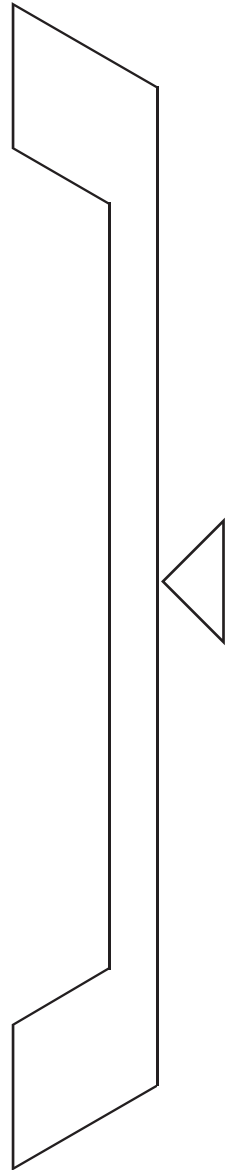
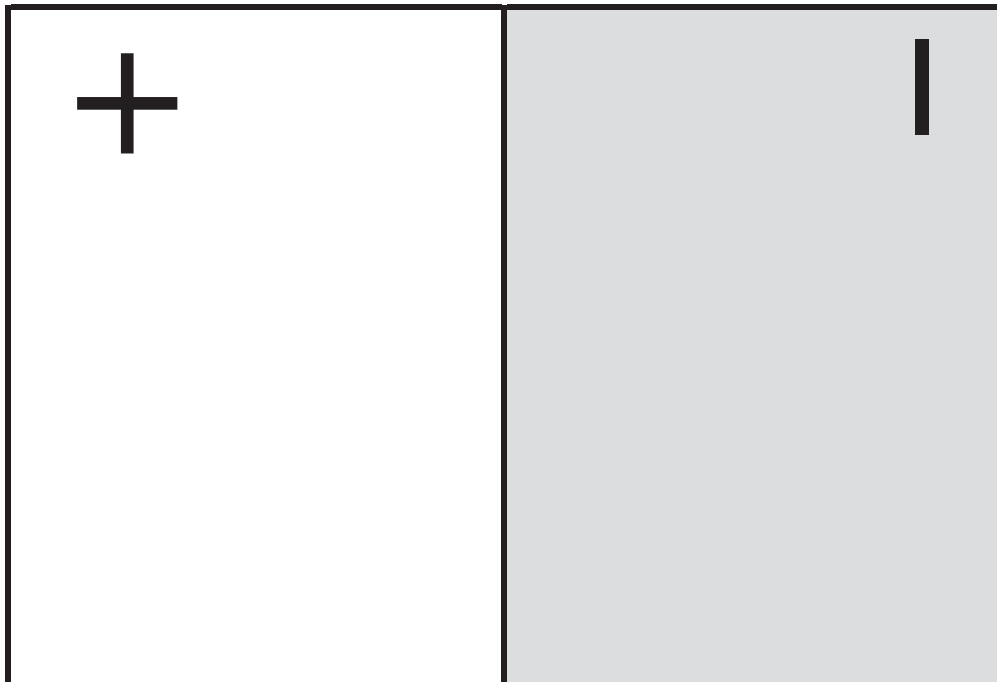
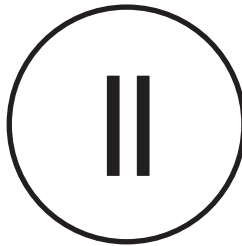

Name _____

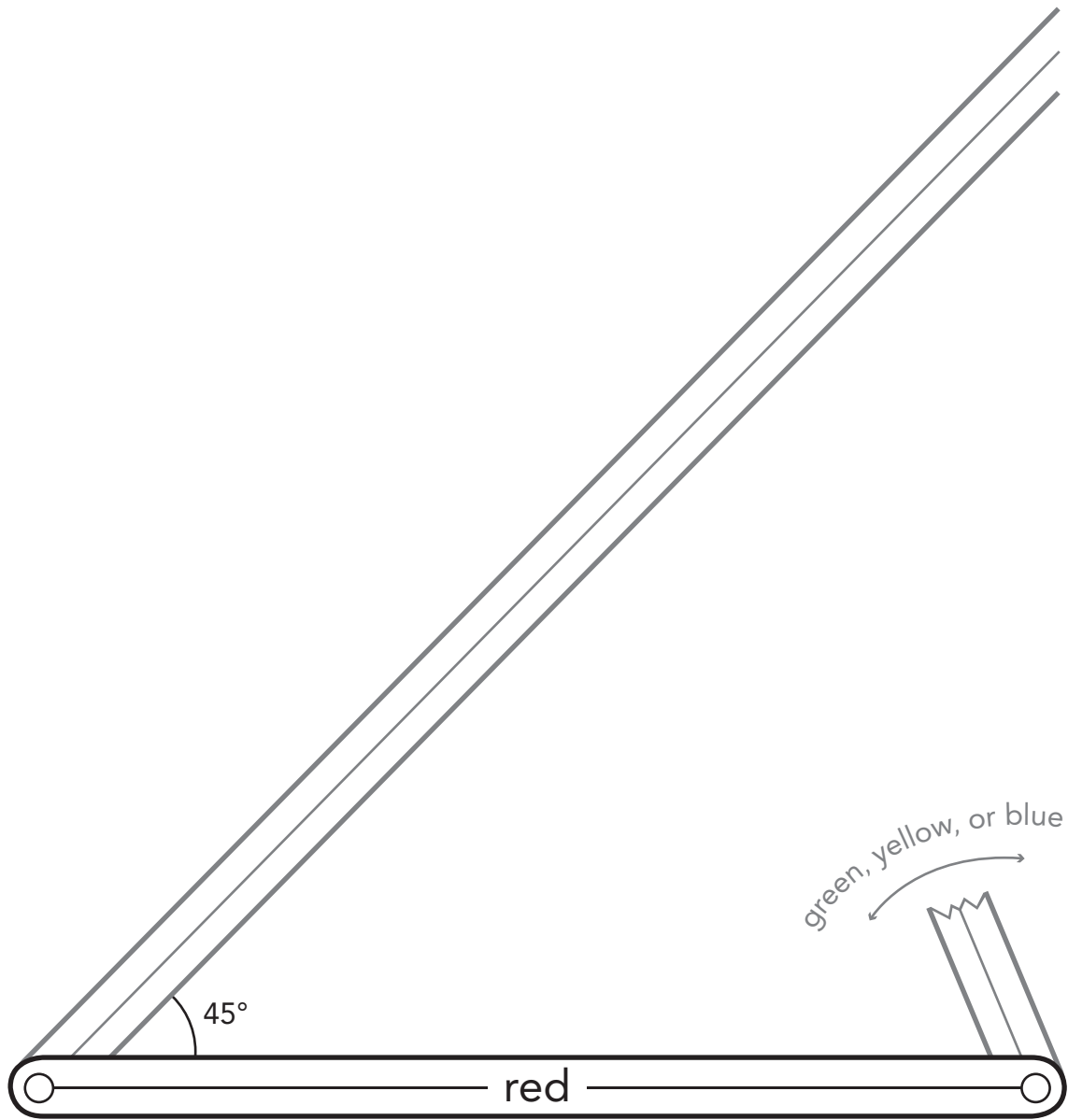

Name _____

Name _____

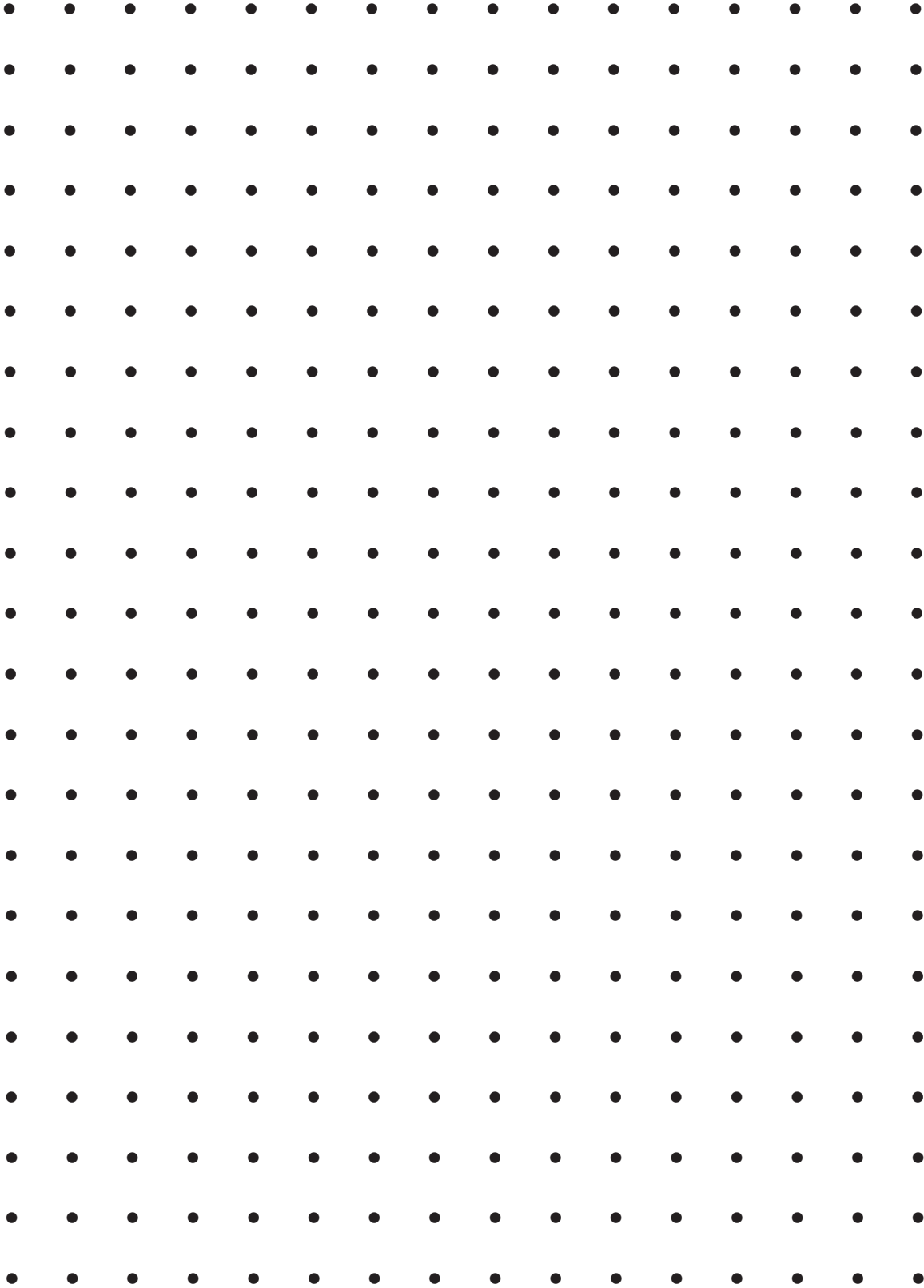

Name _____

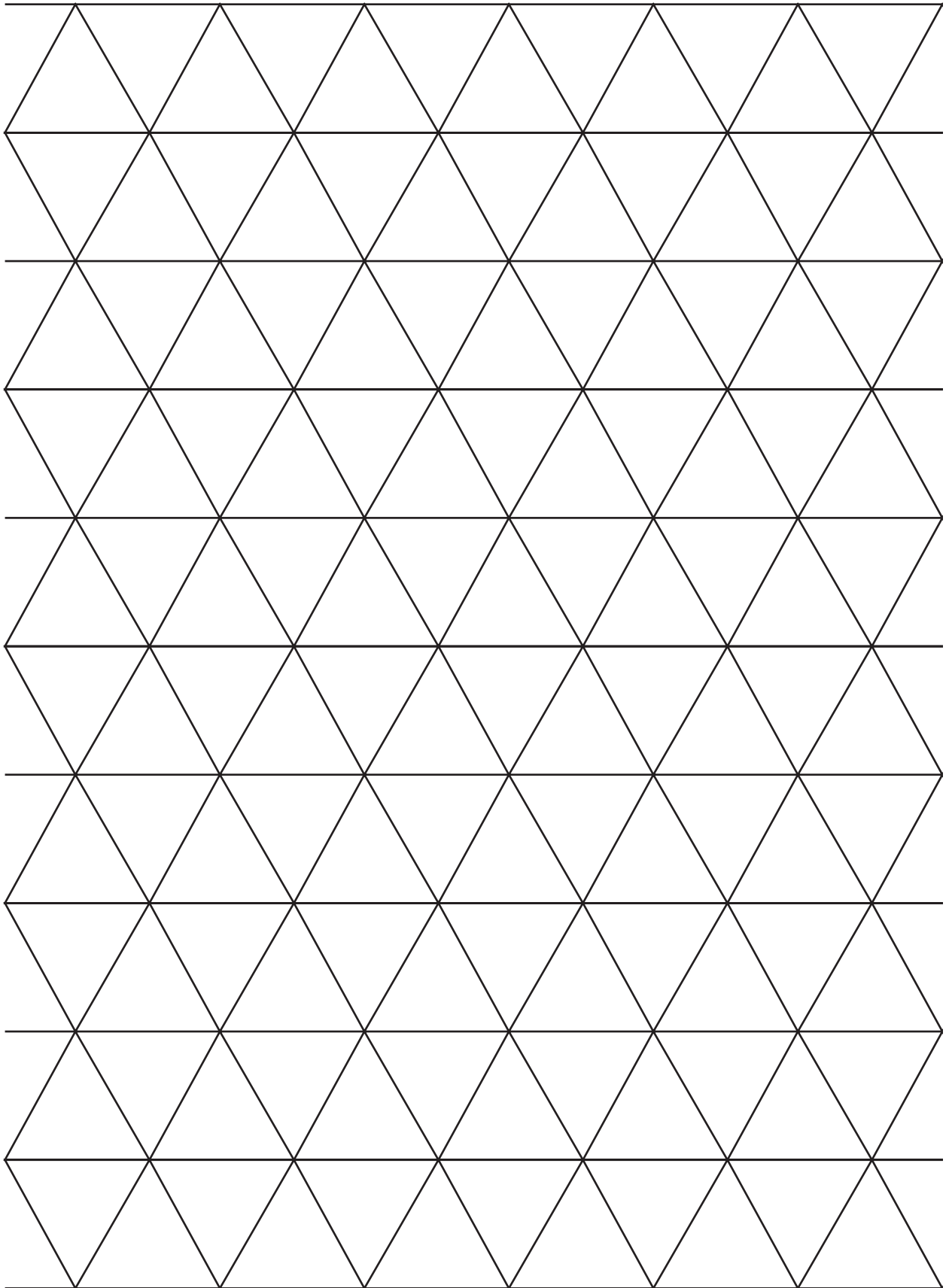

Name _____

