

ADJUSTABLE-SHELF

Specification:

1. Material: MDF + Plywood + Birch
2. Finish: See Table
3. Hardware: See Table
4. Slides: USE58-300-18 + US-CLIP-4W (7 Set)
5. Hinge: 700.0536.25 + 600.1234.05 (4 Set)
6. Shelf Supports: 1707BN (4 PCS)
7. The tolerance is +/- 1/8"

Item number	Finish	Deco Hardware	
		Item number	Qty
VN2THE-48-BK-NT	Black	A500-4PC	8
VN2THE-48-BL-NT	Blue	A500-4ABG	8
VN2THE-48-BS-NT	Bule Steel	A500-4PC	8
VN2THE-48-GR-NT	Grey	A500-4PC	8
VN2THE-48-WH-NT	White	A500-4PC	8
VN2THE-48-DW-NT	Dark Walnut	A500-4ABG	8
VN2THE-48-NO-NT	Natural Oak	A500-4MB	8

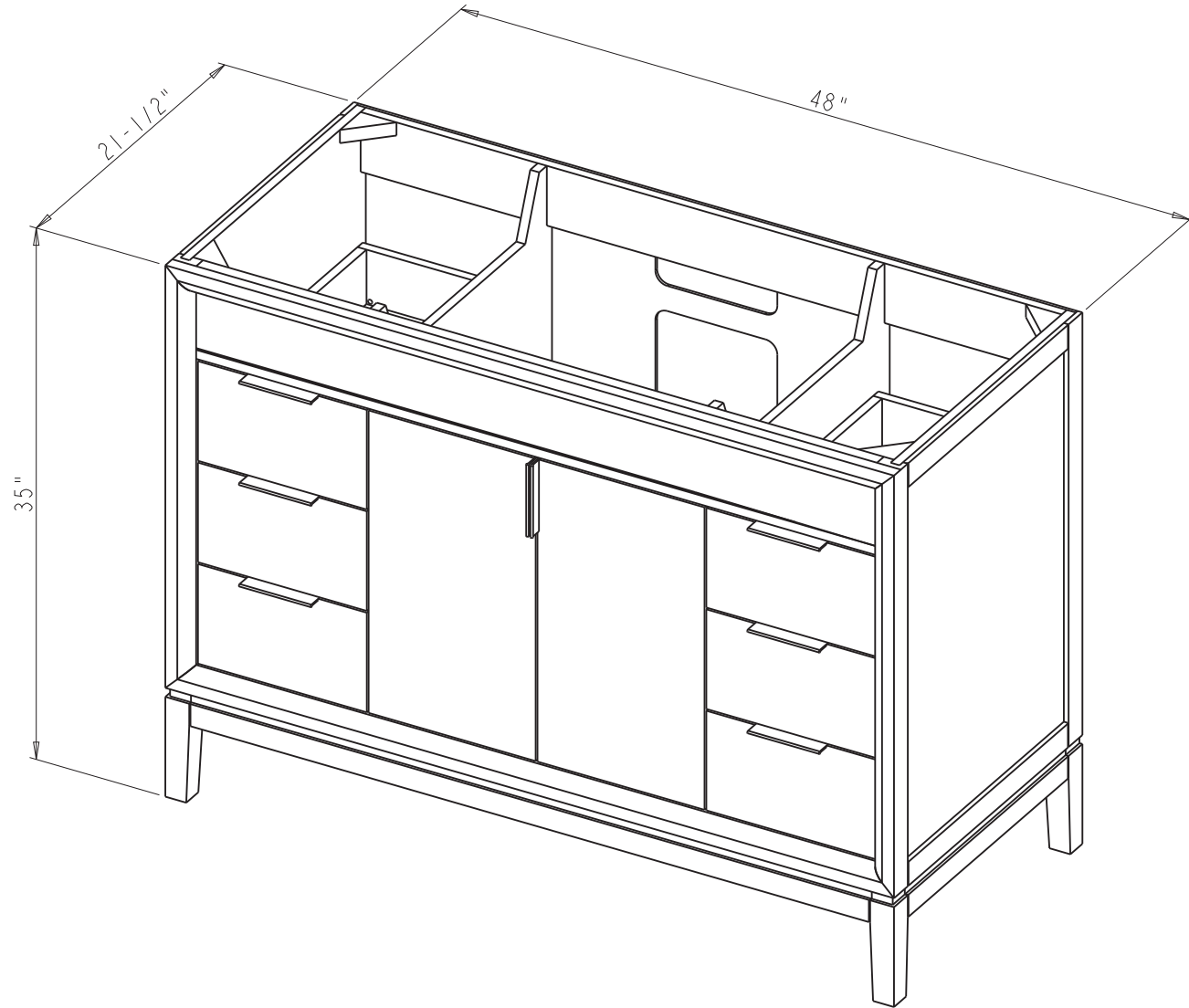

<p>hardware resources</p> <p><small>PROPRIETARY AND CONFIDENTIAL</small></p> <p><small>THE INFORMATION CONTAINED IN THIS DRAWING IS THE SOLE PROPERTY OF HARDWARE RESOURCES INC. ANY REPRODUCTION IN PART OR AS A WHOLE WITHOUT THE WRITTEN PERMISSION OF HARDWARE RESOURCES INC. IS PROHIBITED.</small></p> <p><small>DO NOT SCALE DRAWING</small></p>	ITEM:	VN2THE-48		MATERIAL:		
	FINISH:			WEIGHT:	9	
				PROJECTION		
	TOLERANCE UNLESS OTHERWISE SPECIFIED:	UNITS:	DRAWN BY:	DATE:		
X ±0.20		<i>Hugo.cai</i>	May-18-21			
X.X ±0.10	SIZE:	APPROVED BY:	DATE:			
X.XX ±0.05	SHEET:	RELEASE LEVEL:	REVISION:			
ANGULAR: ±0.5°						



 PROPRIETARY AND CONFIDENTIAL THE INFORMATION CONTAINED IN THIS DRAWING IS THE SOLE PROPERTY OF HARDWARE RESOURCES INC. ANY REPRODUCTION IN PART OR AS A WHOLE WITHOUT THE WRITTEN PERMISSION OF HARDWARE RESOURCES INC. IS PROHIBITED.	ITEM:	VN2THE - 48		MATERIAL:		
	FINISH:			WEIGHT:	9	
	TOLERANCE UNLESS OTHERWISE SPECIFIED:			UNITS:	DRAWN BY:	DATE:
	DO NOT SCALE DRAWING			SIZE:	APPROVED BY:	DATE:
X ±0.20 X.X ±0.10 X.XX ±0.05 ANGULAR: ±0.5°			SHEET:	RELEASE LEVEL:	REVISION:	
			TONY HUANG Tony.Huang		May-20-21	

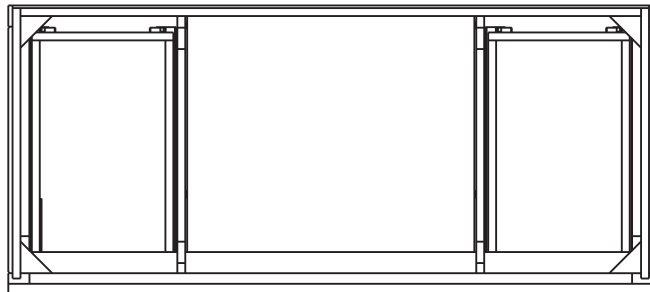
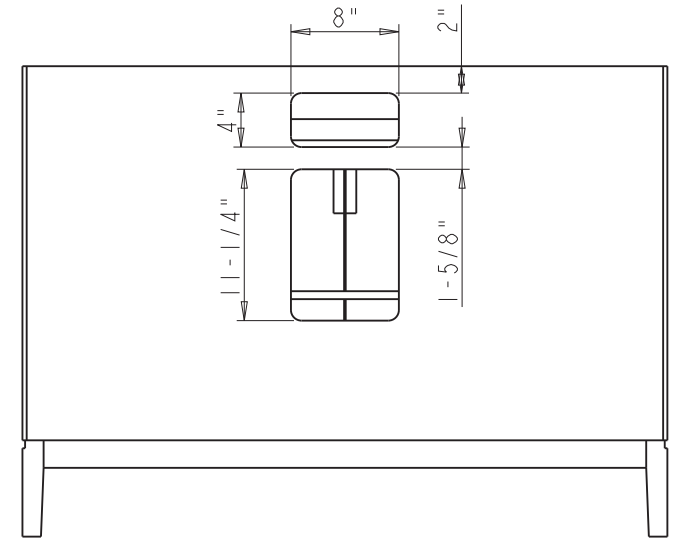
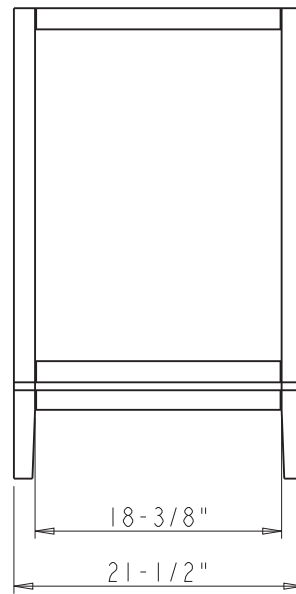
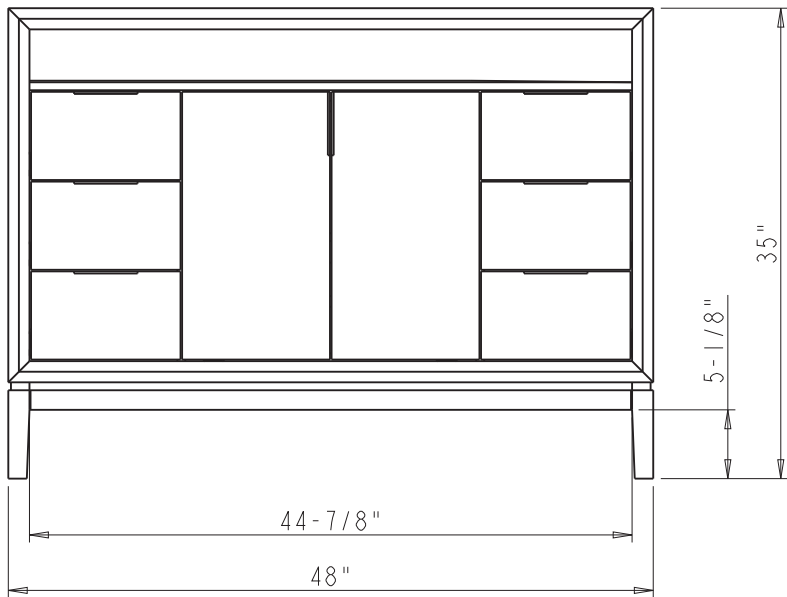



 PROPRIETARY AND CONFIDENTIAL THE INFORMATION CONTAINED IN THIS DRAWING IS THE SOLE PROPERTY OF HARDWARE RESOURCES INC. ANY REPRODUCTION IN PART OR AS A WHOLE WITHOUT THE WRITTEN PERMISSION OF HARDWARE RESOURCES INC. IS PROHIBITED.	ITEM:	VN2THE - 48		MATERIAL:
	FINISH:			WEIGHT:
				PROJECTION
				
TOLERANCE UNLESS OTHERWISE SPECIFIED:		UNITS:	DRAWN BY:	DATE:
X ±0.20			<i>Tony.Huang</i>	May-20-21
X.X ±0.10		SIZE:	APPROVED BY:	DATE:
X.XX ±0.05				
ANGULAR: ±0.5°		SHEET:	RELEASE LEVEL:	REVISION:
DO NOT SCALE DRAWING				