

ASSEMBLY AND INSTALLATION INSTRUCTIONS

P0413

WARNING: TO AVOID RISK OF ELECTRICAL SHOCK, BE SURE TO SHUT OFF POWER WHILE INSTALLING OR SERVICING THIS FIXTURE.

NOTE: 1. Before installing, consult local electrical codes for wiring and grounding requirements.

2. Read and save this instructions.

Hardware Package (included):

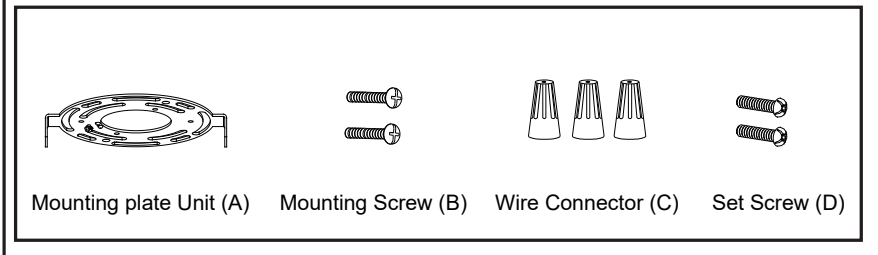

Installation Steps

Turn off the power at fuse or circuit box

1. Unscrew the two set screws (DD), remove the ceiling pan (A) from the mounting plate unit (AA).
2. Attach mounting plate unit (AA) to the outlet box using two mounting screws (BB).
3. Rod Connections:
 - a. Thread the fixture wire through the lower rod, then secure the lower rod onto the fixture using the threaded pipe.
 - b. Thread the fixture wire through the middle rod and then secure the middle rod onto the lower rod using the threaded pipe.
 - c. Thread the fixture wire through the upper rod, then secure the upper rod onto the middle rod using the threaded pipe.

Note: Length adjustable from 34-3/4" to 64-3/4". Use fewer rods if shorter length is desired.
4. Thread the fixture wires through the canopy kit, then secure the rod assembly to the set threaded pipe of the canopy kit.
5. Pull out the source wires from the outlet box. Make wire connections using wire connectors (CC) as follows:
 - Connect the hot wire (black insulation) from the fixture to the black wire from the power source.
 - Connect the neutral wire (white insulation) from the fixture to the white wire from the power source.
 - Attach the fixture ground wire (bare wire) to the mounting plate unit (AA) with the green ground screw, then depending on local code, connect it to the house ground wire with the wire connector (CC).Carefully put all of the wires back into the outlet box.
6. Attach the ceiling pan (A) to the mounting plate unit (AA) by using two set screws (DD).

Turn on the power at fuse or circuit box

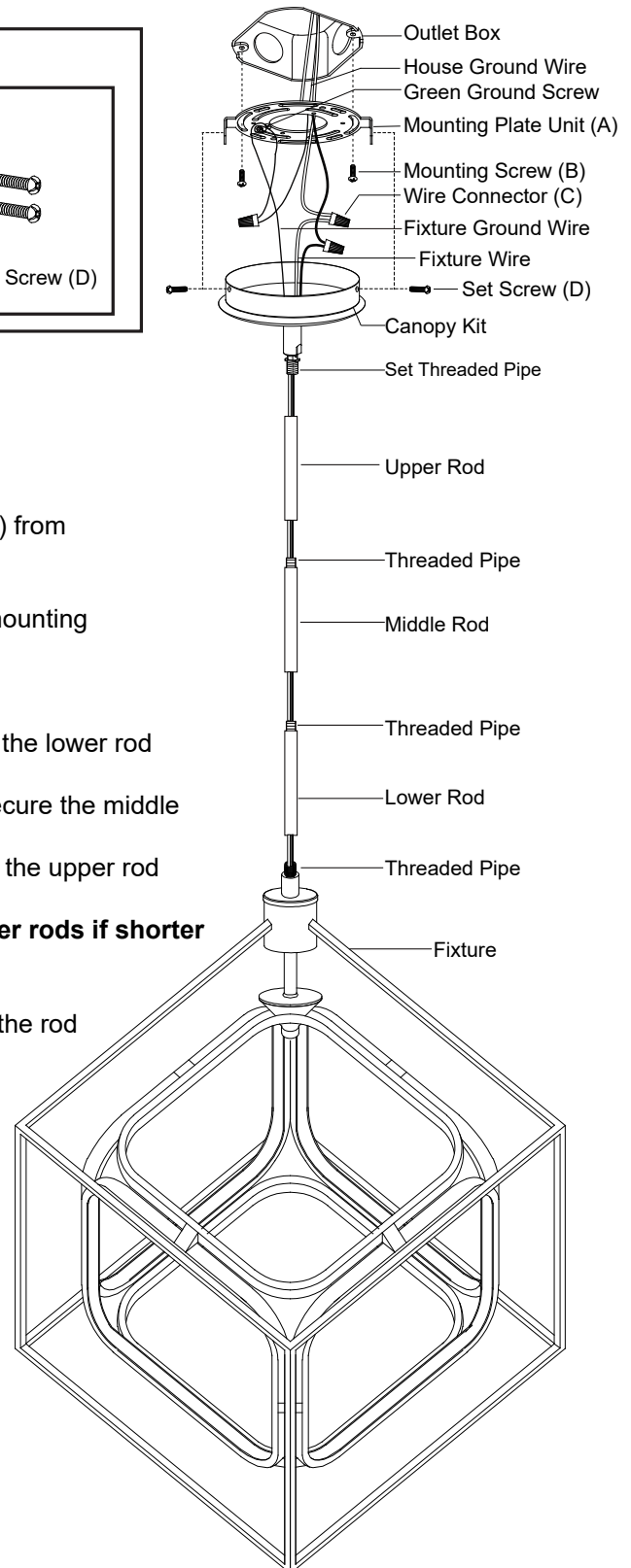







Note: Dimming range: 100% full illumination to 10% of full illumination.

This fixture is dimmable with a forward phase electronic dimmer. Dimmers tested to be compatible with this fixture are the Lutron: TGCL-153PH, MACL-153MH, SCL-153P, DVWCL-153PH.

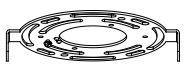
If you are unfamiliar with electrical installations, it is recommended you have a qualified electrician for your installations.

The following parts are available for reorder if damaged or missing.

Spare Parts List:

				→ Mounting Hardware 6842MM (1SET)		
Mounting plate Unit (A)	Mounting Screw (B)	Wire Connector (C)	Bolt Nut (D)		12" Rod 3368RD	6" Rod 3369RD

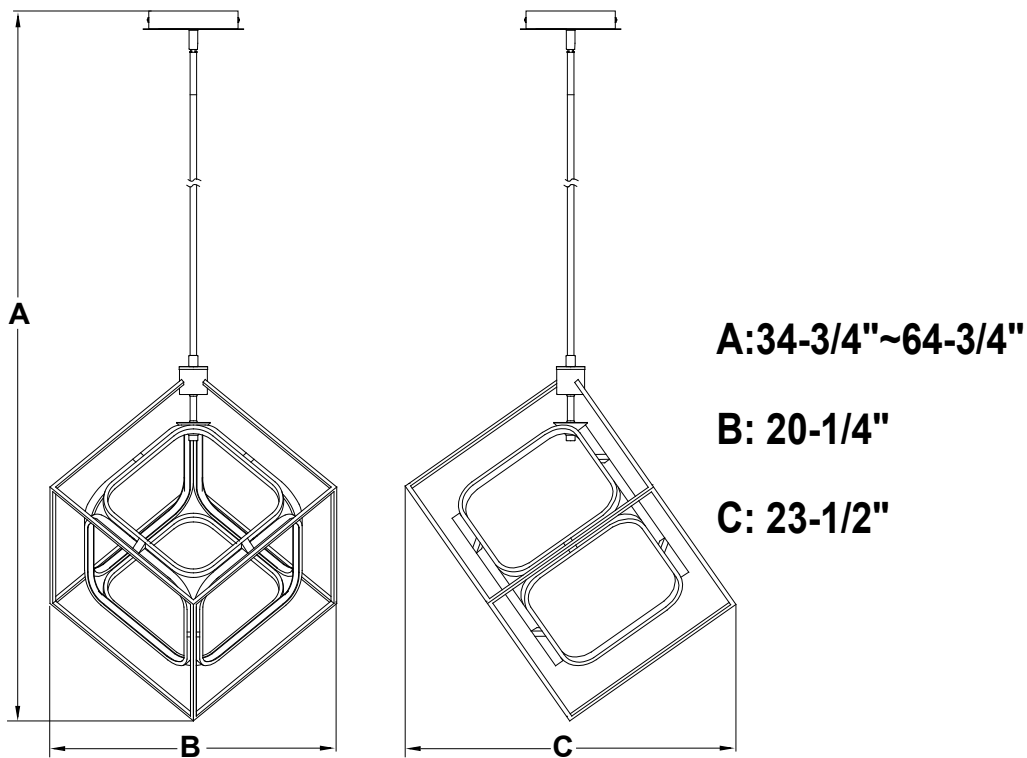

5 Year Limited Warranty

Vaxcel warrants all of our products against defects in workmanship and finishes for one year following the date of shipment.

In addition:

- Any product with an integrated motion sensor or dusk-to-dawn photocell is supported by a 5-year warranty for the functionality of the product.
- Any product with integrated LED modules is covered by a 5-year warranty on the LED functionality.

Exclusions: This warranty does not include the failure of products from extreme acts of nature; environmental conditions not suited for the products intended use; operation in temperatures outside of the range specified in the instruction manual; usage with improper power supply, power surges or dips. For coastal locations, some corrosion is considered normal for the environment.

Vaxcel reserves the right to repair, replace or issue a credit for any properly installed product, provided it is returned per RMA instruction. This warranty is limited to the cost of the product only and does not extend to transportation, installation or replacement costs.

How can warranty service be obtained?

info@vaxcel.com

1-800-482-9235