









# HEKMAN®

A HOWARD MILLER COMPANY

## 24408 SOFA TABLE

PART INSIDE			HARDWARE LIST				
1	2	3	A	B	C	D	
TOP PANEL (1 Pc)	SHELF (1 Pc)	LEGS (2 Pcs)	ALLEN BOLT M6 X 20 (12 PCS.)	FLAT W. M6 12 PCS.	SPRING W. M6 12 PCS.	ALLEN KEY L4 (FOR ALLEN BOLT) 1 PC.	
							

### STEP 1.

LAY TOP PANEL (1) SOFA COFFEE TABLE UPSIDE DOWN ON A SOFT, CLEAN AND FLAT SURFACE. ALIGN STRETCHER TO HOLES ON LEGS (3) AND CONNECT USING PLAIN WASHER (B), SPRING WASHER (C), ALLEN BOLT (A) AND ALLEN KEY (D) PROVIDED.

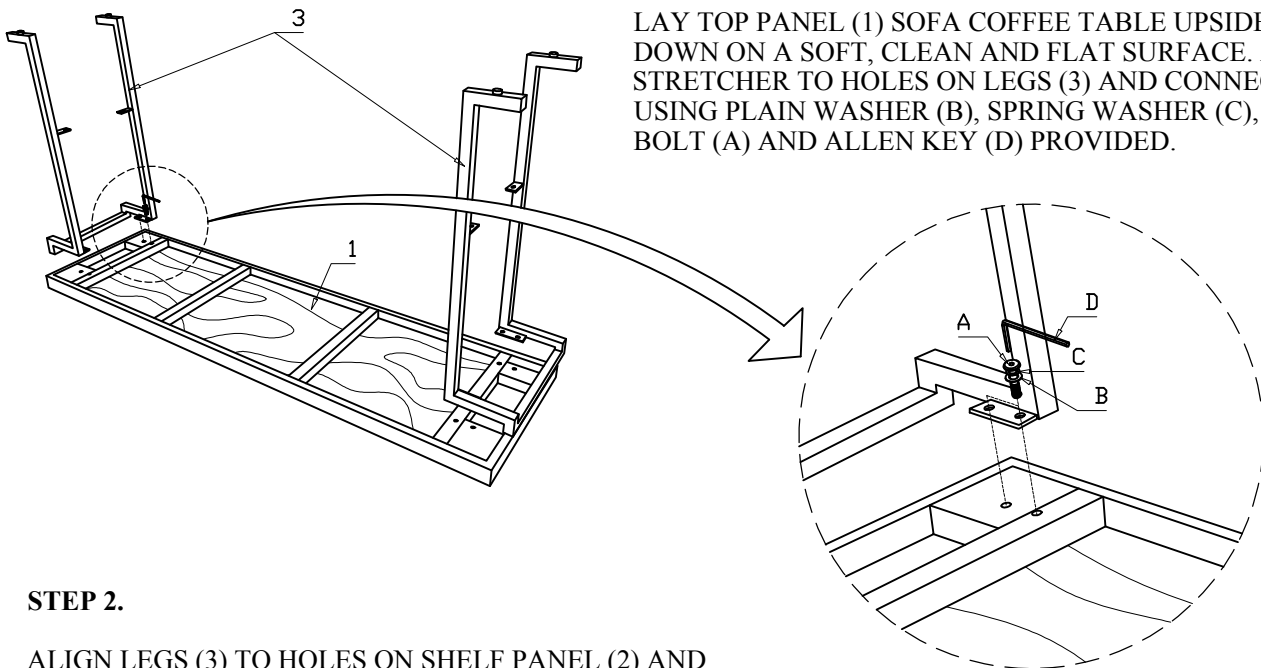

### STEP 2.

ALIGN LEGS (3) TO HOLES ON SHELF PANEL (2) AND CONNECT USING FLAT WASHER (B), SPRING WASHER (C), ALLEN BOLT (A) AND ALLEN KEY (D) PROVIDED. TIGHTEN ALL

