

### Features

- Includes faceplate with handle, bath spout, shower arm and flange
- A single handle controls both on/off activation and temperature setting
- Supplied with ADA-compliant metal Pure design lever handle
- Integrated push-button diverter
- Includes nondiverter bath spout with 1/2" NPT connection
- For use with any KOHLER showerhead (sold separately)
- Complements Pinstripe faucets and accessories

### Material

- Premium material construction with metal handle ensures reliability and durability
- KOHLER finishes resist corrosion and tarnishing

### Installation

- Trim only; requires valve to complete installation (sold separately)

### Required Products/Accessories

K-11748 Series Rite-Temp® Valves

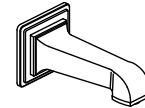
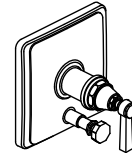
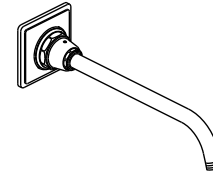

### Codes/Standards

ASME A112.18.1/CSA B125.1



### KOHLER® Faucet Lifetime Limited Warranty

See website for detailed warranty information.

### Available Colors/Finishes

*Color tiles intended for reference only.*

Color	Code	Description
-------	------	-------------

	CP	Polished Chrome
	SN	Vibrant® Polished Nickel
	BN	Vibrant® Brushed Nickel

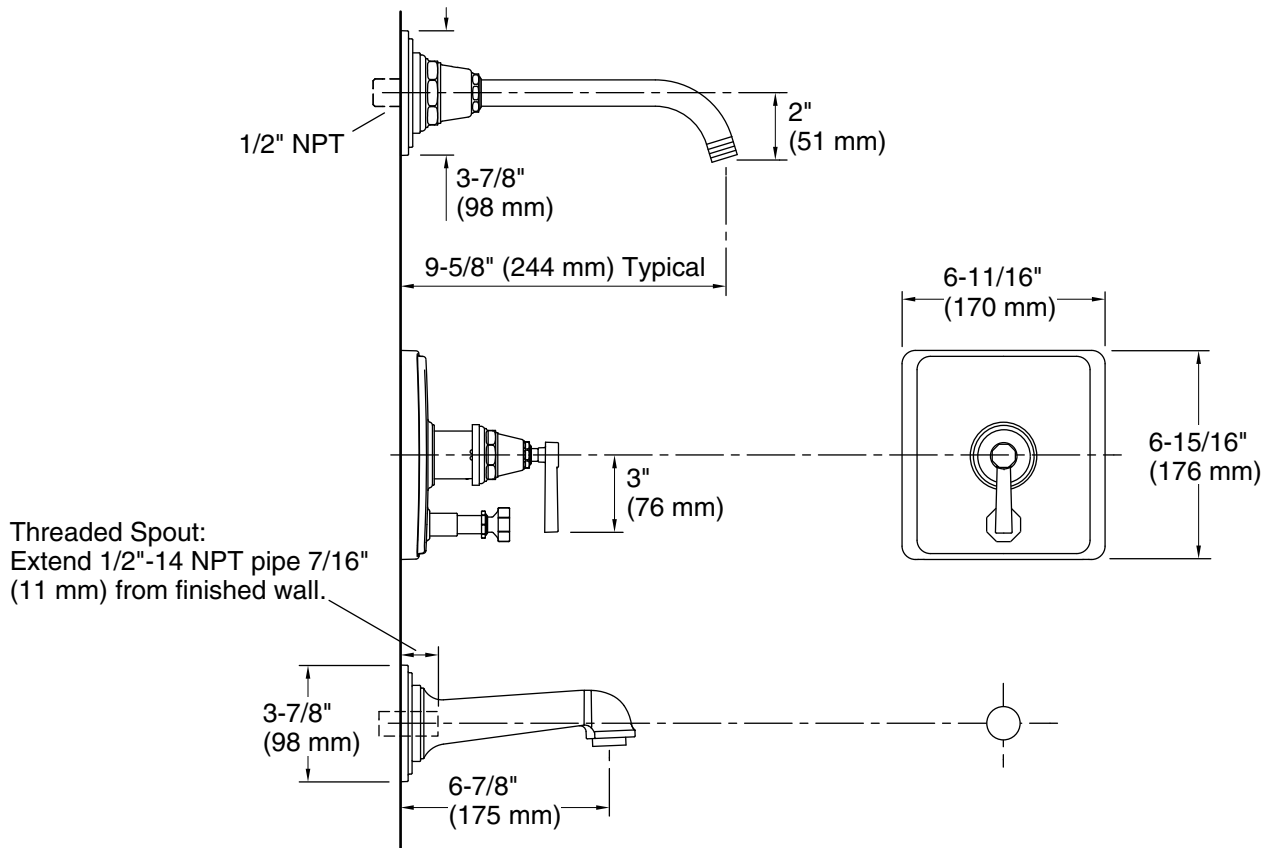

**Technical Information**

All product dimensions are nominal.

**Spout:**

Spout reach: 6-7/8" (175 mm)

**Notes**

Install this product according to the installation instructions.

Avoid cross-flow conditions. Do not install shut-off device on either valve outlet.

Cap the shower outlet if deck-mount spout, diverter, or handshower is connected to the spout outlet.

Install straight pipe or tube drop of 7" (178 mm) to 18" (457 mm) with single elbow between the valve and wall-mount spout.