

Features

- Designed in collaboration with Studio McGee
- Single lever handle controls flow to outlets
- 360° handle rotation with three-outlet operation
- 120° handle rotation with two-outlet operation
- Coordinates with other products in the Castia collection
- Trim only; requires K-728-K two- or three-way transfer valve, or K-737-K two- or three-way diverter valve (sold separately)

Material

- Premium material construction with metal handle ensures reliability and durability
- KOHLER finishes resist corrosion and tarnishing

Installation

- Patented K-joint installation technology ensures consistent trim appearance, regardless of variability in valve rough-in
- Wall-mount
- Trim only; requires valve to complete installation (sold separately)

Required Products/Accessories

- K-728-K 3/4" two- or three-way transfer valve
- or
- K-737-K 3/4" Two- or Three-Way Diverter Valve

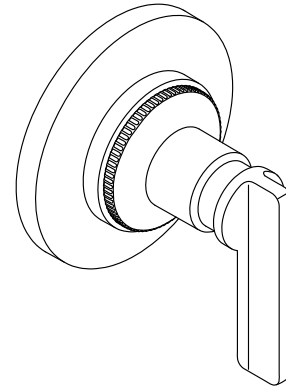

Codes/Standards





- ASME A112.18.1/CSA B125.1
- ADA
- ICC/ANSI A117.1
- CSA B651
- OBC

KOHLER® Faucet Lifetime Limited Warranty

See website for detailed warranty information.

Available Colors/Finishes

Color tiles intended for reference only.

Color	Code	Description
	CP	Polished Chrome
	SN	Vibrant® Polished Nickel
	BN	Vibrant® Brushed Nickel
	BL	Matte Black
	2MB	Vibrant® Brushed Moderne Brass

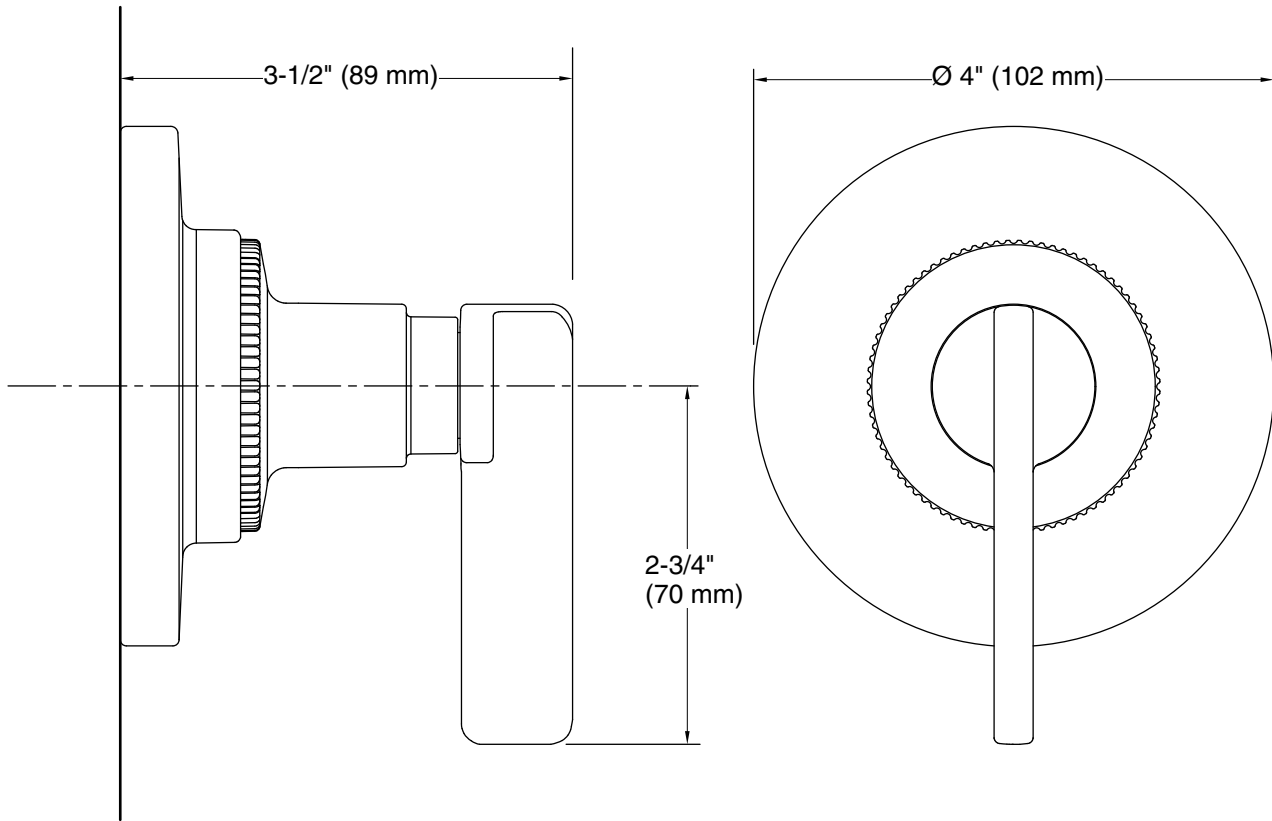

Technical Information

All product dimensions are nominal.

Spout:

Notes

Install this product according to the installation instructions.

ADA, OBC, CSA B651 compliant when installed to the specific requirements of these regulations.