

# Operation Manual

## Smart-UPS<sup>™</sup> Uninterruptible Power Supply

750/1000/1500/2200/3000 VA  
Tower / Rack-Mount 2U  
120 Vac/230 Vac

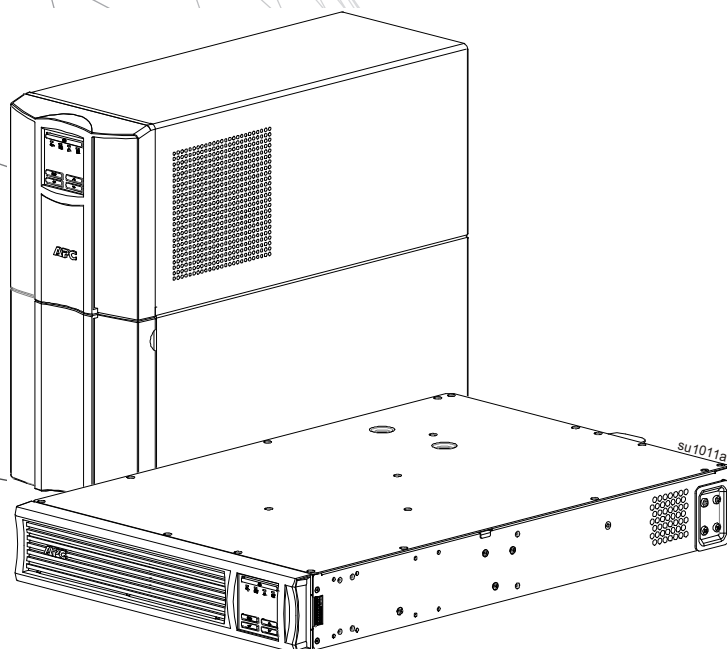

**For Professional Business Applications – Not For Consumer Use**



# Important Safety Instructions

SAVE THESE INSTRUCTIONS - This manual contains important instructions that should be followed during installation and maintenance of the UPS and batteries.

Read the instructions carefully. Become familiar with the device before trying to install, operate, service or maintain it. The following special messages may appear throughout this document or on the equipment to warn of potential hazards or to call attention to information that clarifies or simplifies a procedure.



The addition of this symbol either to a Danger or Warning product safety label indicates that an electrical hazard exists that will result in personal injury if the instructions are not followed.



This is the safety alert symbol. It is used to alert you to potential personal injury hazards. Obey all safety messages that follow this symbol to avoid possible injury or death.

## **DANGER**

**DANGER** indicates a hazardous situation which, if not avoided, will result in death or serious injury.

## **WARNING**

**WARNING** indicates a hazardous situation which, if not avoided, could result in death or serious injury.

## **CAUTION**

**CAUTION** indicates a hazardous situation which, if not avoided, could result in minor or moderate injury.

## **NOTICE**

**NOTICE** is used to address practices not related to physical injury.

# Product Handling Guidelines



<18 kg  
<40 lb



18-32 kg  
40-70 lb



32-55 kg  
70-120 lb



>55 kg  
>120 lb



# Safety and General Information

**Inspect the package contents upon receipt.**

**Notify the carrier and dealer if there is any damage.**

- Adhere to all national and local electrical codes.
- All wiring must be performed by a qualified electrician.
- **Changes and modifications to this unit not expressly approved by APC by Schneider Electric could void the warranty.**
- This equipment is intended for indoor use only.
- Do not operate this unit in direct sunlight, in contact with fluids, or where there is excessive dust or humidity.
- Be sure the air vents on the UPS are not blocked. Allow adequate space for proper ventilation.
- For a UPS with a factory installed power cord, connect the UPS power cable directly to a wall outlet. Do not use surge protectors or extension cords.
- The equipment is heavy. Always practice safe lifting techniques adequate for the weight of the equipment.

## Deenergizing safety

The UPS contains internal batteries and may present a shock hazard even when disconnected from the branch circuit (mains). Before installing or servicing the equipment check that the:

- Input circuit breaker is in the **OFF** position.
- Internal UPS batteries are removed.

## Electrical safety

- Use tools with insulated handles.
- Do not handle any metallic connector before power has been disconnected.
- For models with a hardwired input, the connection to the branch circuit (mains) must be performed by a qualified electrician.
- 230 V models only: In order to maintain compliance with the EMC regulations, output cords and network cables attached to the UPS must not exceed 10 meters in length.
- The protective earth conductor for the UPS carries the leakage current from the load devices (computer equipment). An insulated ground conductor is to be installed as part of the branch circuit that supplies the UPS. The conductor must have the same size and insulation material as the grounded and ungrounded branch circuit supply conductors. The conductor will typically be green, with or without a yellow stripe.
- Leakage current for a pluggable, Type A UPS may exceed 3.5 mA when a separate ground terminal is used.
- The UPS input ground conductor must be properly bonded to protective earth at the service panel.
- If the UPS input power is supplied by a separately derived system, the ground conductor must be properly bonded at the supply transformer or motor generator set.

## Hardwire safety

- Check that all branch circuit (mains) and low voltage (control) circuits are deenergized, and locked out before installing cables or making connections, whether in the junction box or to the UPS.
- Wiring by a qualified electrician is required.
- Check national and local codes before wiring.
- Strain relief is required for all hardwiring (supplied with select products). Snap-in type strain reliefs are recommended.
- All openings that allow access to UPS hardwire terminals must be covered. Failure to do so may result in personal injury or equipment damage.
- Select wire size and connectors according to national and local codes.

## Battery safety

### CAUTION

#### RISK OF HYDROGEN SULPHIDE GAS AND EXCESSIVE SMOKE

- Replace the battery at least every 5 years or at the end of its service life, whichever is earlier.
- Replace the battery immediately when the UPS indicates battery replacement is necessary.
- Replace batteries with the same number and type of batteries as originally installed in the equipment.
- Replace the battery immediately when the UPS indicates a battery overtemperature condition, or when there is evidence of electrolyte leakage. Power off the UPS, unplug it from the AC input, and disconnect the batteries. Do not operate the UPS until the batteries have been replaced.

**Failure to follow these instructions could result in equipment damage and minor or moderate injury.**

- The batteries typically last for two to five years. Environmental factors impact battery life. Elevated ambient temperatures, poor quality utility power, and frequent short duration discharges will shorten battery life. The battery should be replaced before end of life.
- Servicing of batteries should be performed or supervised by personnel knowledgeable of batteries and the required precautions. Keep unauthorized personnel away from batteries.
- CAUTION: Failed batteries can reach temperatures that exceed the burn thresholds for touchable surfaces.
- CAUTION: A battery can present a risk of electrical shock and high short circuit current. The following precautions should be observed when working on batteries:
  - Disconnect the charging source prior to connecting or disconnecting battery terminals.
  - Do not wear any metal objects including watches and rings.
  - Do not lay tools or metal parts on top of batteries.
  - Use tools with insulated handles.
  - Wear rubber gloves and boots.
  - Determine if battery is either intentionally or inadvertently grounded. Contact with any part of a grounded battery can result in electric shock and burns by high short-circuit current. The risk of such hazards can be reduced if grounds are removed during installation and maintenance by a skilled person.
- Schneider Electric uses sealed lead acid batteries. Under normal use and handling, there is no contact with the internal components of the battery. Over charging, over heating or other misuse of batteries can result in a discharge of battery electrolyte. Released electrolyte is toxic and may be harmful to the skin and eyes.
- CAUTION: Before installing or replacing the batteries, remove jewelry such as wristwatches and rings. High short circuit current through conductive materials could cause severe burns.
- CAUTION: Do not dispose of batteries in a fire. The batteries may explode.
- CAUTION: Do not open or mutilate batteries. Released material is harmful to the skin and eyes and may be toxic.

## General information

- The model and serial numbers are located on a small, rear panel label. For some models, an additional label is located on the chassis under the front bezel.
- Always recycle used batteries.
- Recycle the packaging materials or save them for reuse.

## FCC Class A radio frequency warning

This equipment has been tested and found to comply with the limits for a Class A digital device, pursuant to part 15 of the FCC Rules. These limits are intended to provide reasonable protection against harmful interference when the equipment is operated in a commercial environment. This equipment generates, uses, and can radiate radio frequency energy and, if not installed and used in accordance with the instruction manual, may cause harmful interference to radio communications. Operation of this equipment in a residential area is likely to cause harmful interference in which case the user will be required to correct the interference at his own expense.

**WARNING:** This is a category C2 UPS product. In a residential environment, this product may cause radio interference, in which case the user may be required to take additional measures.

**SMT750RM2UC, SMT750RM2UCNC, and SMT750RM12UC Rack-Mount**

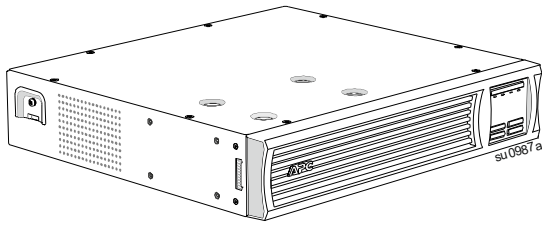

**SMT750C and SMT750IC Tower**

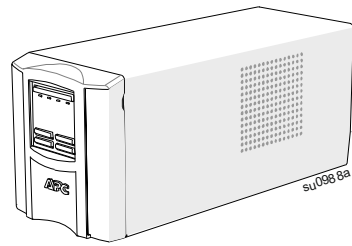

**SMT1000RM2UC, SMT1000RM12UC, SMT1500RM2UC, SMT1500RM2UCNC, and SMT1500RM12UC Rack-Mount**

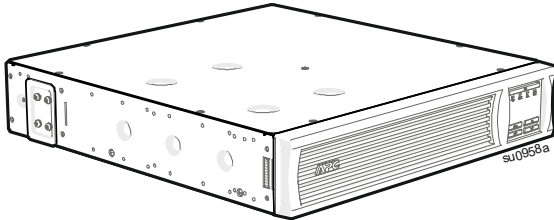

**SMT1000C, SMT1000IC, SMT1500C, SMT1500IC and SMT1500CNC Tower**

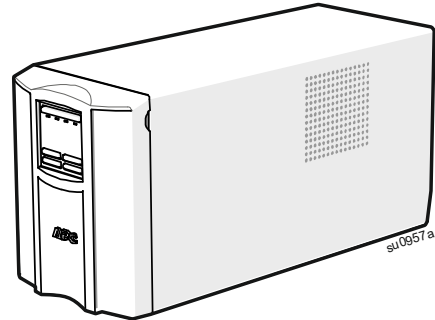

**SMT2200RM2UC, SMT2200RM2UCNC, SMT2200RM12UC, SMT3000RM2UC, SMT3000RM2UCNC, and SMT3000RM12UC Rack-Mount**

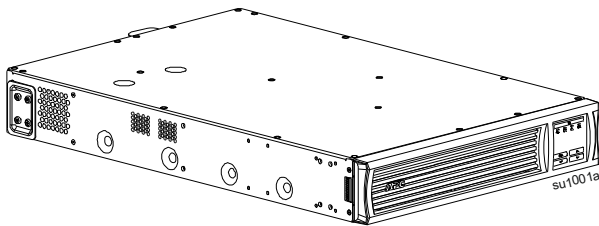

**SMT2200C, SMT2200IC, SMT3000C and SMT3000IC Tower**

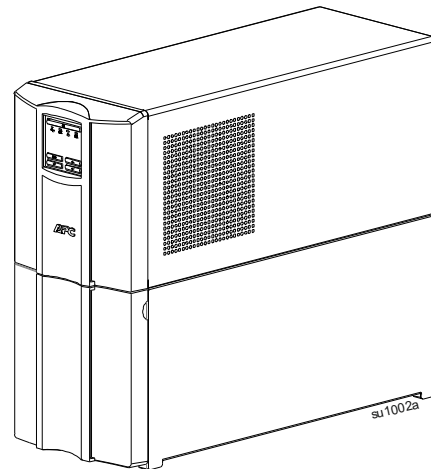

## Specifications

For additional specifications, refer to the APC Web site at [www.apc.com](http://www.apc.com).

### Environmental specifications

<b>Temperature</b>	<b>Operating</b>	0° to 40° C (32° to 104° F)
	<b>Storage</b>	-15° to 45° C (5° to 113° F) charge UPS battery every six months
<b>Maximum Elevation</b>	<b>Operating</b>	3,000 m (10,000 ft)
	<b>Storage</b>	15,000 m (50,000 ft)
<b>Humidity</b>		0% to 95% relative humidity, non-condensing
<b>International Protection Code</b>		IP20
<b>Pollution degree</b>		2
<b>Overvoltage category</b>		II
<b>Applicable power grid power distribution system</b>		TN Power System
<b>Applicable standard</b>		IEC 62040-1

# Product Overview

## SMT750RM2UC, SMT750RM2UCNC and SMT750RMI2UC Rack-Mount

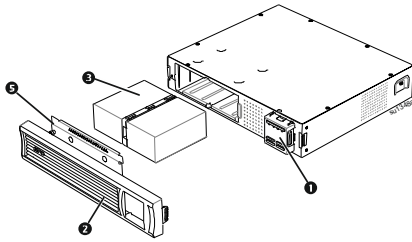

## SMT1000RM2UC, SMT1000RMI2UC, SMT1500RM2UC, SMT1500RM2UCNC, and SMT1500RMI2UC Rack-Mount

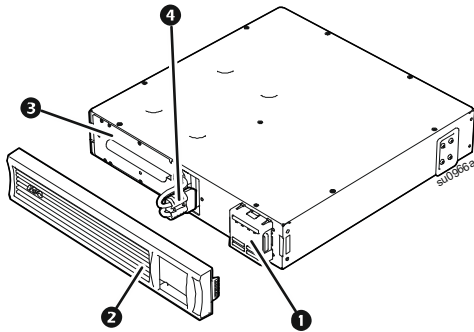

## SMT1500C, SMT1500IC and SMT1500CNC Tower

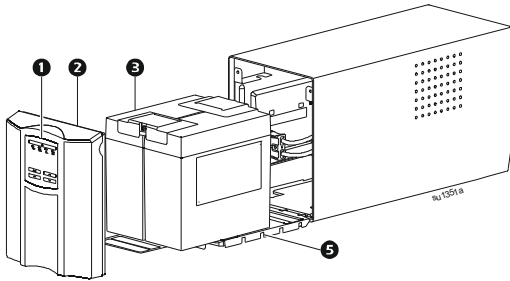

## SMT750C and SMT750IC Tower

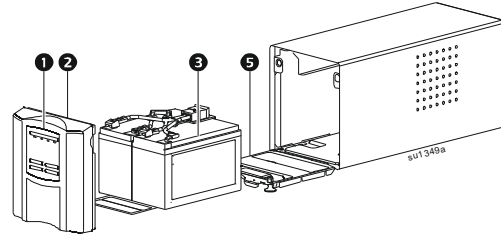

## SMT1000C and SMT1000IC Tower

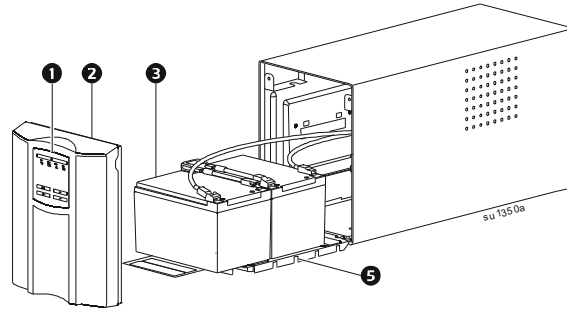

## SMT2200C, SMT2200IC, SMT3000C and SMT3000IC Tower

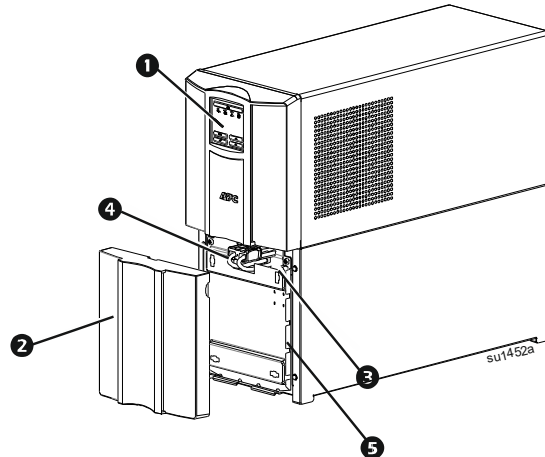

## SMT2200RM2UC, SMT2200RM2UCNC, SMT2200RMI2UC, SMT3000RM2UC, SMT3000RM2UCNC, and SMT3000RMI2UC Rack-Mount

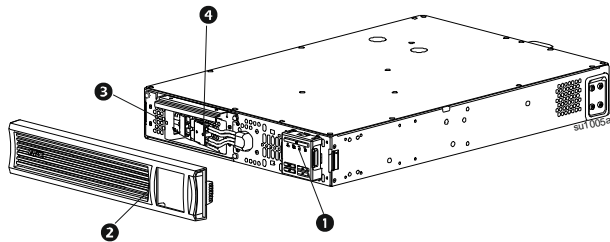

- ❶ Display (more information below)
- ❷ Bezel
- ❸ Battery
- ❹ Internal battery connector
- ❺ Battery compartment door

## Front panel display features

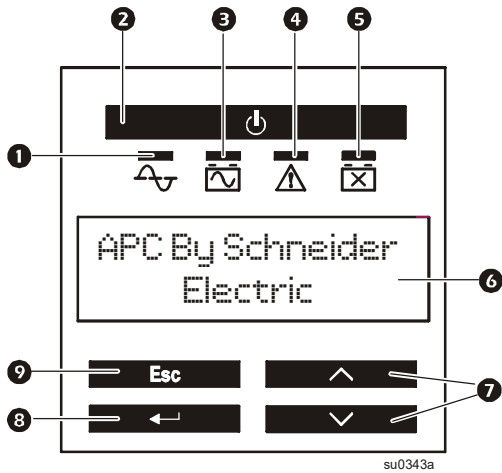

- ❶ Online LED
- ❷ UPS ON/OFF key
- ❸ On Battery LED
- ❹ Error Detected LED
- ❺ Replace Battery LED
- ❻ Multi-lingual display screen
- ❼ UP/DOWN Selection arrows
- ❽ ENTER key
- ❾ ESCAPE key

## Rear panel features

❶ SmartConnect Ethernet port	❻ Output circuit breaker/overload protection
❷ Serial port - Use this serial port for monitoring the UPS. Refer to “Connect and Install Management Software” on page 13 for details.	❼ Controlled outlet group
❸ USB port - Use this port to connect to a computer for monitoring or gracefully shutting down the UPS using PowerChute software. Refer to “Connect and Install Management Software” on page 13 for details.	❽ Outlets
❹ Chassis ground connection screw	❹ UPS input
❺ Smart Slot for optional Network Management Card (NMC) accessory card (NOTE: NMC is factory installed in models having “NC” as the last two characters in the model number.)	❿ Battery connector (located on the front panel of rack-mount models)
	⓫ Input circuit breaker
	⓬ EPO connector

### SMT750RM2UC and SMT750RM2UCNC Rack-Mount

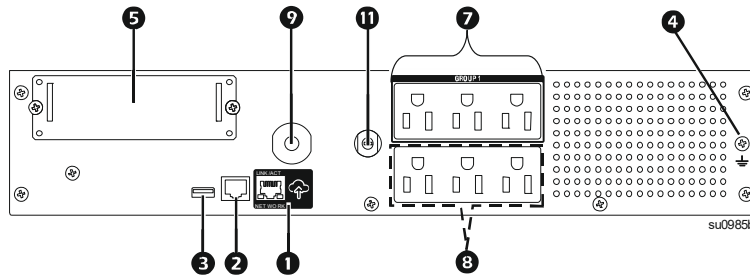

### SMT750RM12UC Rack-Mount

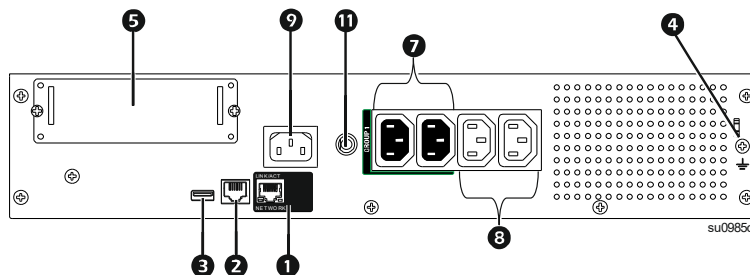



**SMT1000RM2UC, SMT1500RM2UC and SMT1500RM2UCNC Rack-Mount**

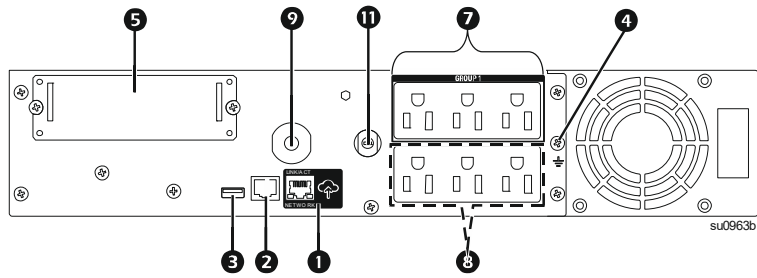

**SMT1000RM2UC and SMT1500RM2UC Rack-Mount**

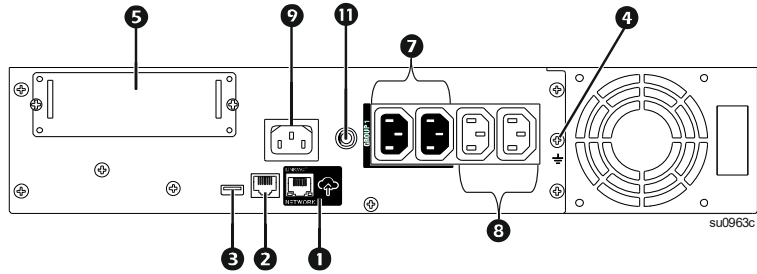

**SMT2200RM2UC, SMT2200RM2UCNC, SMT3000RM2UC and SMT3000RM2UCNC Rack-Mount**

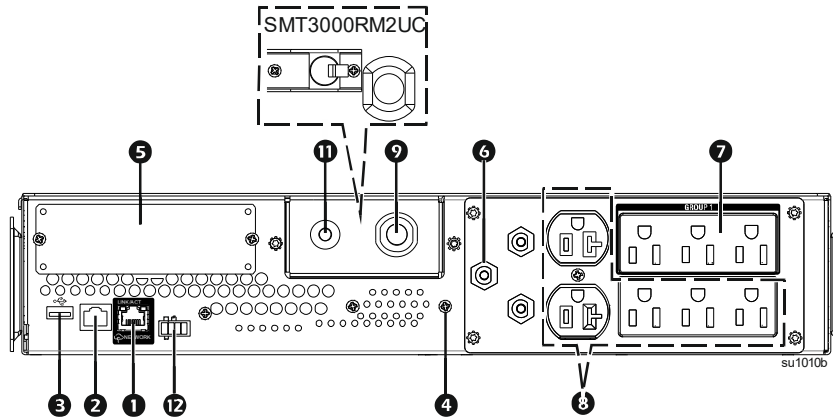

**SMT2200RM2UC and SMT3000RM2UC Rack-Mount**

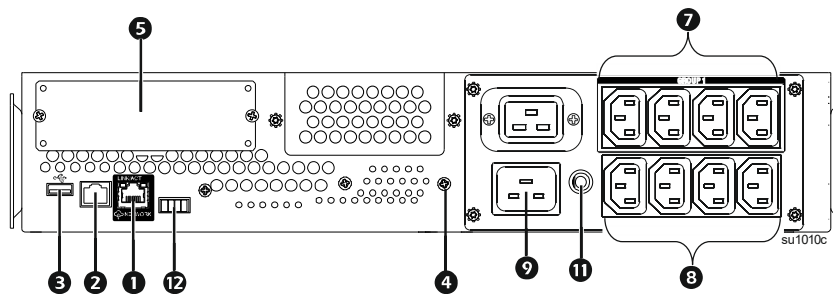

**SMT750C Tower**

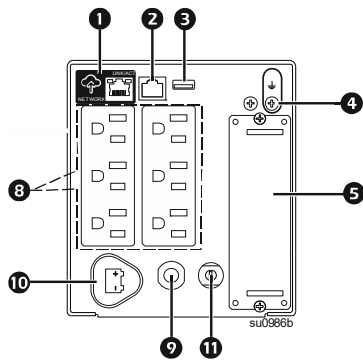

**SMT750IC Tower**

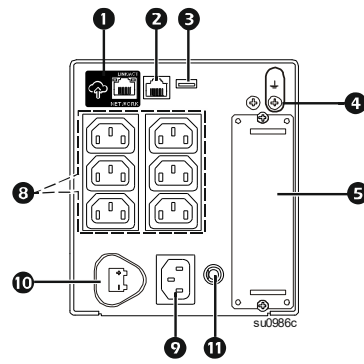

**SMT1000C, SMT1500C and SMT1500CNC Tower**

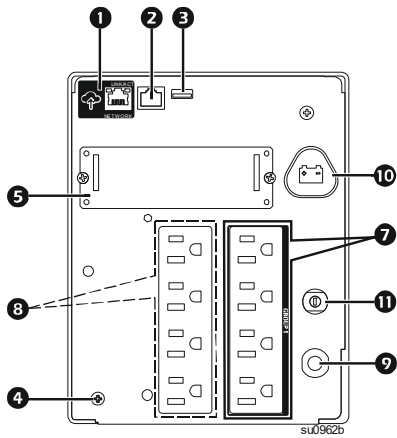

**SMT1000IC and SMT1500IC Tower**

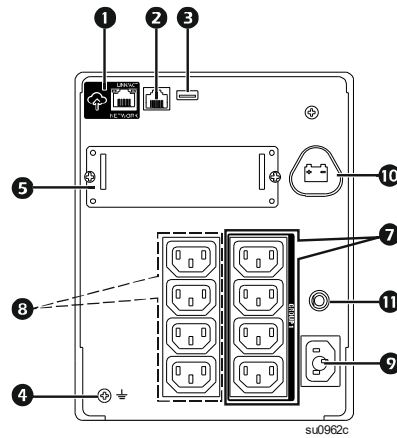

**SMT2200C and SMT3000C Tower**

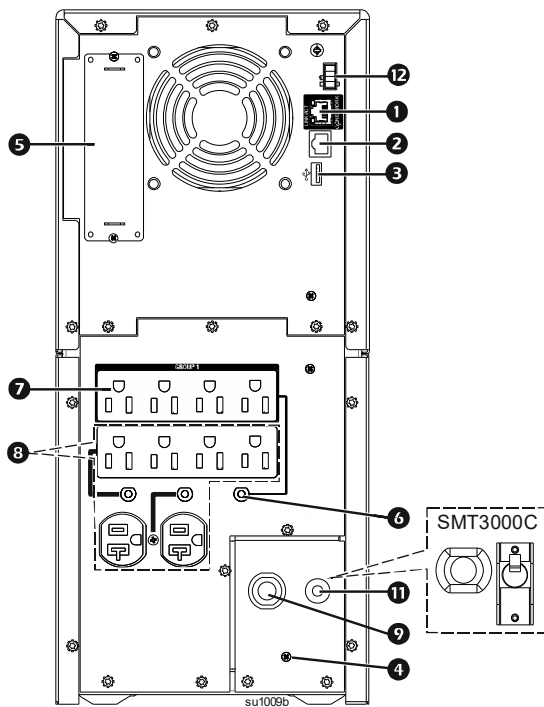

**SMT2200IC and SMT3000IC Tower**

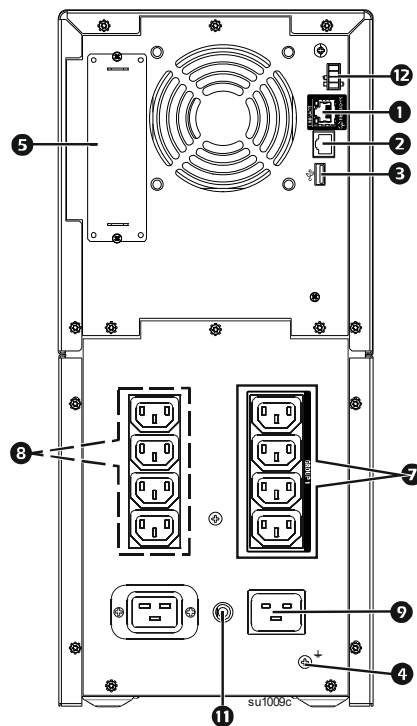

## Dimensions and weights

**SMT750C, SMT750IC, SMT1000C,  
SMT1000IC, SMT1500C, SMT1500CNC and  
SMT1500IC Tower Models**

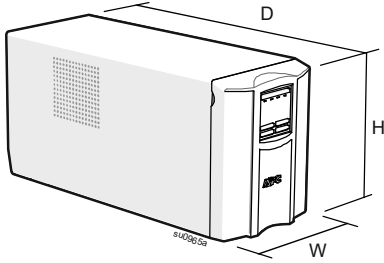

**SMT750RM2UC, SMT750RM2UCNC,  
SMT750RMI2UC, SMT1000RM2UC,  
SMT1000RMI2UC, SMT1500RM2UC,  
SMT1500RM2UCNC and SMT1500RMI2UC  
Rack-Mount Models**

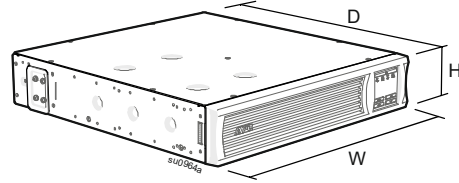

**SMT2200C, SMT2200IC, SMT3000C and  
SMT3000IC Tower Models**

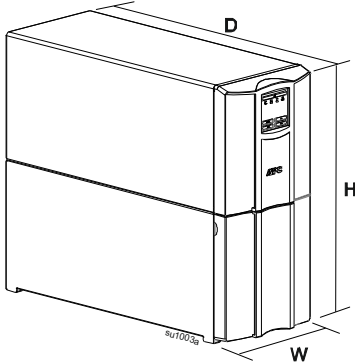

**SMT2200RM2UC, SMT2200RM2UCNC,  
SMT2200RMI2UC, SMT3000RM2UC,  
SMT3000RM2UCNC and SMT3000RMI2UC  
Rack-Mount Models**

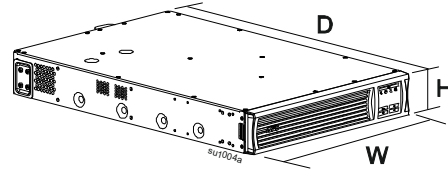

Model	Dimensions (in/mm) H x W x D	Weight (lb / kg)
SMT750C	6.3 x 5.4 x 14.5 in (161 x 138 x 369 mm)	27.6 / 12.5
SMT1000C	8.6 x 6.7 x 17.3 in (219 x 171 x 439 mm)	44.3 / 20.1
SMT1500C/SMT1500CNC		54.2 / 24.6
SMT2200C	17 x 7.7 x 21.4 in (435 x 197 x 544 mm)	112.2 / 50.9
SMT3000C		116.2 / 52.7
SMT750RM2UC/SMT750RM2UCNC	3.4 x 17 x 16 in (86 x 432 x 409 mm)	39 / 17.7
SMT1000RM2UC	3.4 x 17 x 18.8 in (86 x 432 x 477 mm)	55.8 / 25.3
SMT1500RM2UC/SMT1500RM2UCNC		58.4 / 26.5
SMT2200RM2UC/SMT2200RM2UCNC	3.4 x 17 x 26.9 in (86 x 432 x 683 mm)	93.2 / 42.3
SMT3000RM2UC/SMT3000RM2UCNC		97.7 / 44.3
SMT750IC	6.3 x 5.4 x 14.5 in (161 x 138 x 369 mm)	26 / 11.8
SMT1000IC	8.6 x 6.7 x 17.3 in (219 x 171 x 439 mm)	42.8 / 19.4
SMT1500IC		53.1 / 24.1
SMT2200IC	17 x 7.7 x 21.4 in (435 x 197 x 544 mm)	110.6 / 50.2
SMT3000IC		115.7 / 52.5
SMT750RMI2UC	3.4 x 17 x 16 in (86 x 432 x 409 mm)	35.6 / 16.6
SMT1000RMI2UC	3.4 x 17 x 18.8 in (86 x 432 x 477 mm)	49.6 / 22.5
SMT1500RMI2UC		57.5 / 26.1
SMT2200RMI2UC	3.4 x 17 x 26.9 in (86 x 432 x 683 mm)	93.2 / 42.3
SMT3000RMI2UC		97.7 / 44.3

# Installation

For UPS installation information, refer to the Installation Guide included with the UPS.

The Installation Guide is also available on the APC by Schneider Electric Web site, [www.apc.com](http://www.apc.com).

## Network Management card

For installation information, refer the user manual provided with the Network Management Card. The user manual is also available on the APC by Schneider Electric web site at [www.apc.com](http://www.apc.com).

## Placement

The UPS is intended for IT environments. Avoid placement where there is excessive dust, temperature and humidity. Note that temperature in excess of 25° C may have an adverse effect on battery and UPS life. All vents on the side or rear of the UPS should be free of obstructions.

The UPS is heavy. For rack-mount units it is suggested that the batteries be removed for easier installation. The UPS should be placed near the bottom of the rack.

## Connect to equipment and utilities

**NOTE:** The UPS will charge to 90% capacity in the first three hours of normal operation.

**Do not expect full battery runtime capability during this initial charge period.**

### CAUTION

#### RISK OF DAMAGE TO EQUIPMENT OR PERSONNEL



- Adhere to all local and national electrical codes.
- Wiring should be performed by qualified electrician.
- Always connect the UPS to a grounded outlet.



**Failure to follow these instructions can result in injury.**

1. Connect equipment to the outlets in the rear of the UPS. Some models are equipped with controlled outlet groups. Refer to the “Configuration” section of this manual for further instructions on the use of controlled outlet groups.

2. Connect the SmartConnect Ethernet port  to your nearest network switch using the cable provided.

3. Connect the UPS input to AC power.  
**NOTE:** Once power is connected the display will be active.

4. Press the main power button  on the UPS display to turn on the UPS output.  
**NOTE:** The On-line LED  will light green when the output is on.

5. When the UPS is powered on for the first time the LCD screen displays the Setup Wizard and asks a number of basic set-up questions. They can be answered simply by using the arrow   and enter  keys on the display.

6. Log onto [www.smartconnect.apc.com](http://www.smartconnect.apc.com) or scan the QR code to launch the registration process. The website includes instructions to setup your online account, activate your warranty and begin monitoring your UPS remotely. Features vary with terms of use.

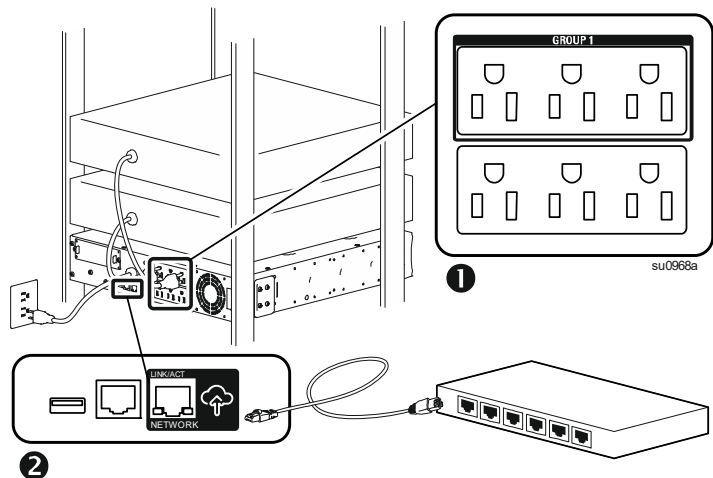

**SMT750RM2UC, SMT750RM2UCNC, and SMT750RMI2UC Rack-Mount Models**

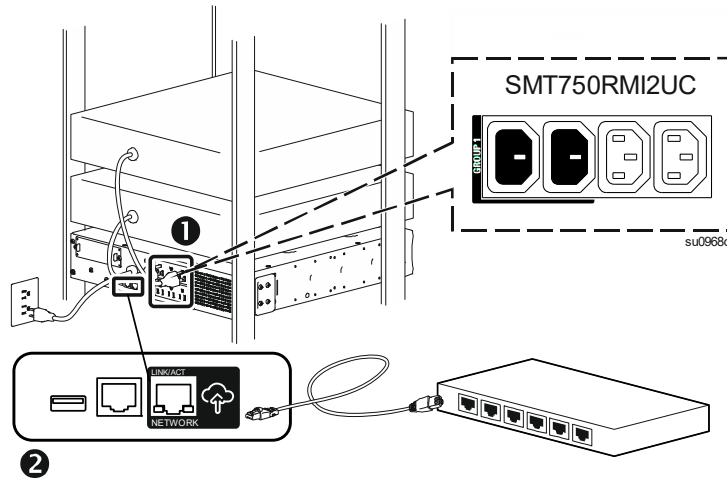

**SMT1000RM2UC, SMT1000RMI2UC, SMT1500RM2UC, SMT1500RM2UCNC and SMT1500RMI2UC Rack-Mount Models**

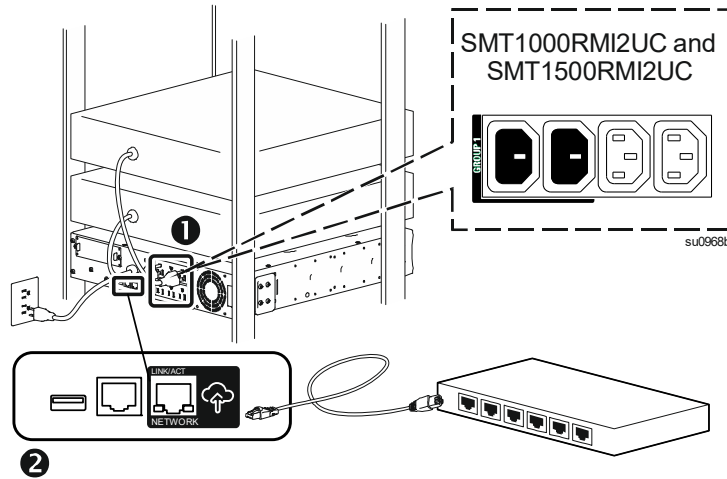

**SMT2200RM2UC, SMT2200RM2UCNC, SMT2200RMI2UC, SMT3000RM2UC, SMT3000RM2UCNC, and SMT3000RMI2UC Rack-Mount Models**

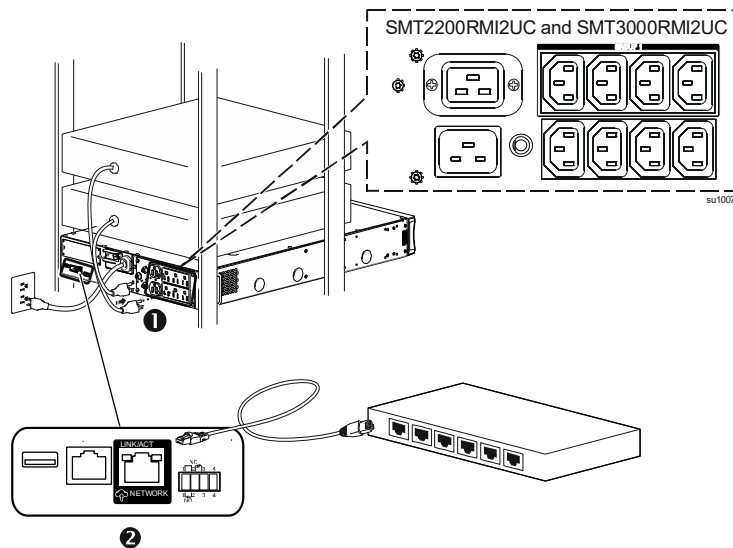

**SMT750C and SMT750IC Tower Models**

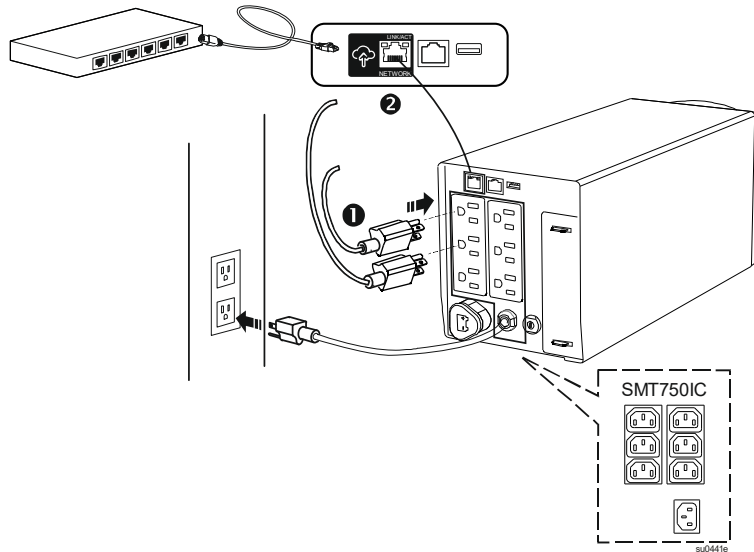

**SMT1000C, SMT1000IC, SMT1500C, SMT1500CNC and SMT1500IC Tower Models**

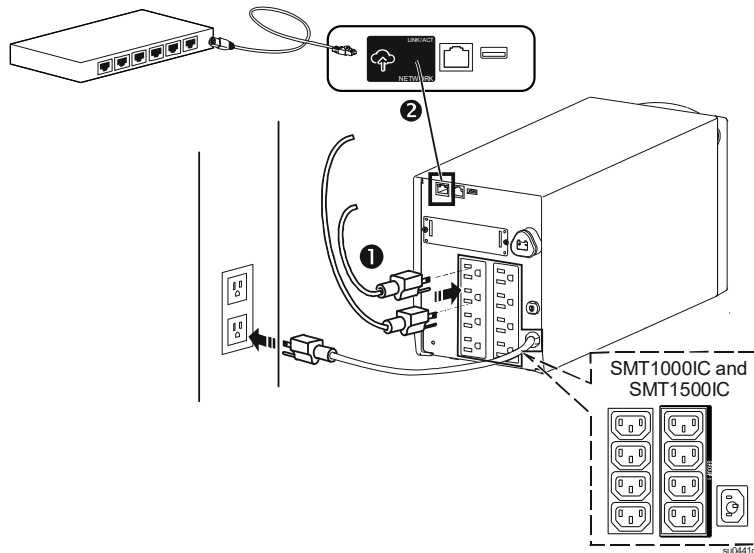

**SMT2200C, SMT2200IC, SMT3000C and SMT3000IC Tower Models**

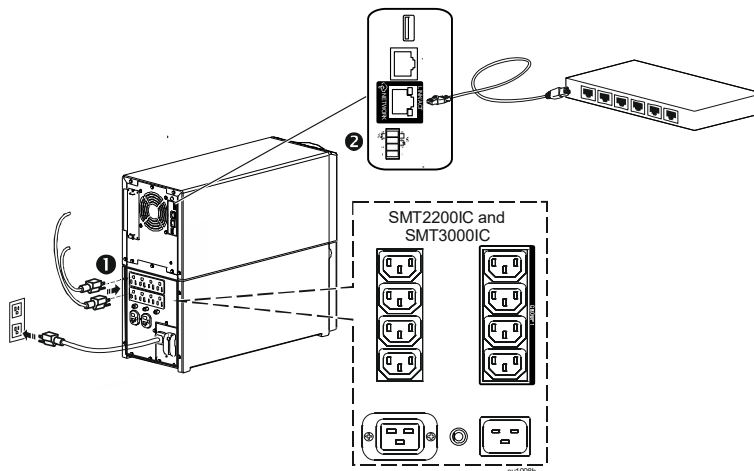



**NOTE:** By connecting this product to the Internet using the SmartConnect Ethernet port, you are agreeing to APC SmartConnect Terms of Use, as found at [smartconnect.apc.com](http://smartconnect.apc.com). Feature availability varies with terms of use. Schneider Electric Data Privacy Policy can also be found at [smartconnect.apc.com](http://smartconnect.apc.com).

# Start up Settings

When the UPS is powered on for the first time the display interface displays the Setup Wizard to configure the start up settings. Configuration can also be performed using PowerChute™ software.

**Note:** If the start up settings asked by the Setup Wizard are not selected completely, turning on UPS output is prohibited. If the UPS output is turned on, the Setup Wizard will be displayed again to complete the configuration of the start up settings.

Function	Factory Default	Options	Description
Language	English	English French* German* Spanish* Italian* Portuguese* Japanese*	The language for the display interface.  *Language options will vary by model.
Local Power Quality	Good	Good Fair Poor	Select the quality of input AC power. <ul style="list-style-type: none"> <li>• If Good is selected, the unit will go on battery power more often to provide the cleanest power supply to the connected equipment.</li> <li>• If Poor is selected, the UPS will tolerate more fluctuations in power and will go on battery power less often.</li> </ul> If unsure of the local power quality, select Good.
Menu Type	Standard	Standard Advanced	The standard menu displays the most commonly required menus for most users. The advanced menus include all parameters.
Today's Date	Manufacture date		Use the   arrows to enter today's day, and the  to complete the settings.

## Connect and Install Management Software

Smart-UPS is provided with PowerChute UPS Management Software for unattended operating system shutdown, UPS monitoring, UPS control and energy reporting. The following diagram is a representation of a typical server installation.

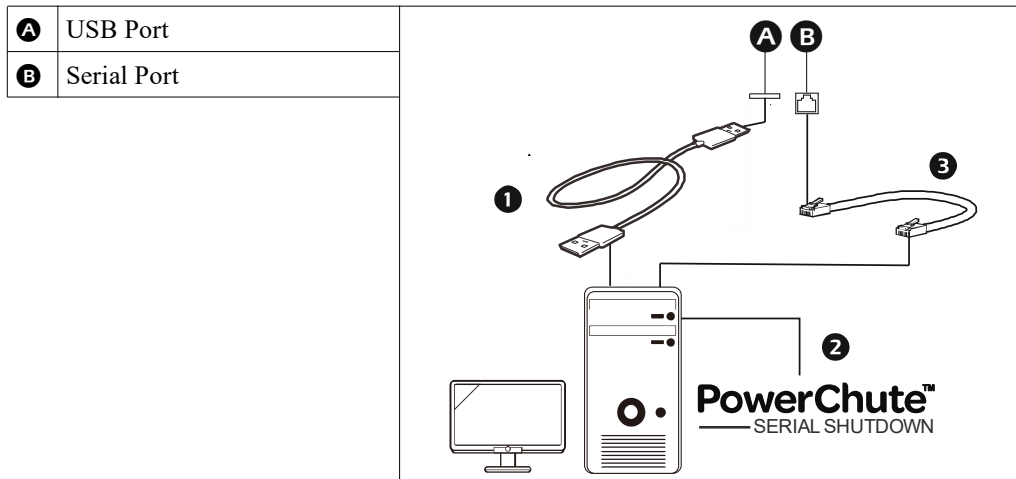









- 1** Connect the USB cable from the rear of the UPS to the protected device such as a server.
  - 2** For a server or other device with an operating system, download and install latest version of the PowerChute Serial Shutdown from <https://www.apc.com/pcss>. PowerChute Serial Shutdown supports graceful shutdown in the event of an extended power outage.  
**NOTE:** PowerChute is a 64-bit only application and cannot be installed on a 32-bit operating system.
  - 3** A built-in Serial port is also available for additional communication options with serial cable.  
**NOTE:** Serial and USB cannot be used at the same time.
- Even more communication options are available via the built-in Smartslot. Refer to [www.apc.com](http://www.apc.com) for more information.

# Operation

## Using the display

These Smart-UPS models are equipped with an intuitive and configurable LCD display. This display complements the software interface as they convey similar information and either may be used to configure the UPS settings.

The display consists of the following keys and indicators:

<p><b>Main on/off</b></p> 	<p>This button is used to turn the UPS output power on and off.</p>
<p><b>Quick status LEDs</b></p>    	<p>The <b>Online</b> indicator illuminates <b>green</b> when UPS output is turned on and operating on AC power.</p> <p>The <b>On-battery</b> indicator illuminates <b>orange</b> and the unit will continue to emit a series of short beeps indicating that the UPS is operating on battery power.</p> <p>The <b>Error Detected</b> LED will illuminate <b>red</b> if the unit detects an internal error. The display screen may also indicate an error message or code.</p> <p>The <b>Replace Battery</b> indicator illuminates <b>red</b> when the UPS battery does not pass self test and requires replacement.</p>
<p><b>Escape</b></p> 	<p>The ESCAPE key always returns the display to the previous screen. It is used to exit the various display menus.</p>
<p><b>Return</b></p> 	<p>The RETURN key is used to confirm a selection and/or enter a menu.</p>
<p><b>Up/down selection arrows</b></p> 	<p>The ARROW keys are used to navigate through each menu selection.</p>

The display has two main display/menu options – standard and advanced.

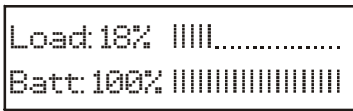

su0983a

**Standard Menu Display**

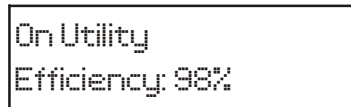

su0984a

**Advanced Menu Display**

**NOTE:** The standard menu is the default setting and does not contain all of the menus and attributes of the advanced menu. The advanced menu automatically scrolls through multiple screens.

## Standard menus

The Standard menus are the most commonly used menus. The following is a list of some items displayed in this menu mode. Visit [apc.com](http://apc.com) for additional details.

Menu	General Functions	
<b>Status</b>	<p>View UPS information:</p> <ul style="list-style-type: none"> <li>• Operating Mode</li> <li>• Efficiency</li> <li>• Load Power</li> <li>• Load VA</li> <li>• Battery Charge state</li> <li>• Estimated Runtime</li> </ul>	<ul style="list-style-type: none"> <li>• Battery Temp</li> <li>• Input</li> <li>• Output</li> <li>• SmartConnect</li> <li>• Probe 1, Probe 2, when NMC and sensor probes are installed</li> </ul>



Menu	General Functions	
<b>Configuration</b>	Configures UPS settings: <ul style="list-style-type: none"> <li>• Language</li> <li>• Green Mode</li> <li>• Local Power Quality: Good, Fair, Poor</li> <li>• Menu Type: Standard or Advanced</li> <li>• Audible Alarm</li> </ul>	<ul style="list-style-type: none"> <li>• Display (Auto Dim, Auto Off, Always On)</li> <li>• Reset to Factory Default</li> <li>• SmartConnect Control</li> <li>• Install FW?</li> </ul>
<b>Test &amp; Diags</b>	Performs UPS tests and diagnostic functions: <ul style="list-style-type: none"> <li>• UPS Self Test</li> <li>• UPS Alarms Test</li> <li>• Calibration Test</li> </ul>	
<b>About</b>	View UPS information: <ul style="list-style-type: none"> <li>• UPS Model</li> <li>• UPS Part No.</li> <li>• UPS Serial No.</li> <li>• UPS Manufacture Date</li> <li>• Battery Part No.</li> <li>• Battery Install Date</li> </ul>	<ul style="list-style-type: none"> <li>• Replace Battery by</li> <li>• Running UPS FW</li> <li>• Available UPS FW</li> <li>• UPS MAC</li> <li>• UPS IP Address</li> <li>• UPS Product Key</li> <li>• SmartSlot Card (if installed)</li> </ul>

## Advanced menus

The Advanced menus provide additional options for the UPS and are available only if the display interface is configured to use the Advanced menus.

Menu	General Functions	
<b>Status</b>	View detailed UPS information: <ul style="list-style-type: none"> <li>• Operating Mode</li> <li>• Efficiency</li> <li>• Load Power</li> <li>• Load VA</li> <li>• Load Amps</li> <li>• Load Energy</li> <li>• Battery Charge State</li> <li>• Estimated Runtime</li> </ul>	<ul style="list-style-type: none"> <li>• Battery Voltage</li> <li>• Battery Temp</li> <li>• Input</li> <li>• Output</li> <li>• Outlet Groups</li> <li>• SmartConnect</li> <li>• Probe 1, Probe 2, when NMC and sensor probes are installed</li> </ul>
<b>Control</b>	Controls the Main and Controlled Outlet Group to turn on, turn off, shutdown, or reboot: <ul style="list-style-type: none"> <li>• UPS Control</li> <li>• Outlet Group Control</li> </ul>	
<b>Configuration</b>	Configure advanced UPS settings: <ul style="list-style-type: none"> <li>• Language</li> <li>• Output Voltage</li> <li>• Green Mode</li> <li>• Local Power Quality</li> <li>• Menu Type</li> <li>• Audible Alarm</li> <li>• Display</li> <li>• Sensitivity</li> <li>• Low Transfer</li> <li>• High Transfer</li> <li>• Low Battery Setting</li> <li>• Auto Self Test</li> </ul>	<ul style="list-style-type: none"> <li>• Reset Energy Meter</li> <li>• Enter Setup Wizard</li> <li>• Reset to Factory Defaults</li> <li>• Site Wiring Fault</li> <li>• Config Main Group Outlets</li> <li>• Config Group Outlets (if Controlled Outlet is available)</li> <li>• ModBus Settings</li> <li>• SmartConnect Control</li> <li>• UPS IP Address Setting</li> <li>• NMC IP Address Settings (if NMC is available)</li> <li>• Install FW? (only available if a firmware update is available)</li> </ul>
<b>Test &amp; Diag</b>	Perform UPS tests and diagnostics functions: <ul style="list-style-type: none"> <li>• UPS Self Test</li> <li>• UPS Alarms Test</li> <li>• Calibration Test</li> </ul>	
<b>Logs</b>	View the error log for information about UPS errors that have occurred.	

Menu	General Functions	
<b>About</b>	View UPS information: <ul style="list-style-type: none"> <li>• UPS Model</li> <li>• UPS Part No.</li> <li>• UPS Serial No.</li> <li>• UPS Manufacture Date</li> <li>• Battery Part No.</li> <li>• Battery Install Date</li> </ul>	<ul style="list-style-type: none"> <li>• Replace Battery by</li> <li>• Running UPS FW</li> <li>• Available UPS FW</li> <li>• UPS MAC</li> <li>• UPS IP Address</li> <li>• UPS Product Key</li> <li>• SmartSlot Card (if installed)</li> </ul>

# Configuration

## General configuration settings

Configuration settings may be changed at any time using the LCD interface or PowerChute software.

Setting	Factory Default	Options	Description
<b>High Transfer</b>	120 V: 127 Vac 230 V: 253 Vac	127 Vac - 136 Vac 253 Vac - 265 Vac	To avoid unnecessary battery usage, set the transfer point higher if the AC voltage is chronically high and the connected equipment is known to work under this condition. The Power Quality setting will automatically change this setting. <b>Note:</b> Use the Advanced Menus to configure this setting.
<b>Low Transfer</b>	120 V: 106 Vac 230 V: 207 Vac	97 Vac - 106 Vac 195 Vac - 207 Vac	Sets the transfer point lower if the AC voltage is chronically low and the connected equipment can tolerate this condition. This setting may also be adjusted using the power quality setting. <b>Note:</b> Use the Advanced Menus to configure this setting.
<b>Sensitivity</b>	Normal	<ul style="list-style-type: none"> <li>• Normal</li> <li>• Reduced</li> <li>• Low</li> </ul>	Selects the level of sensitivity to power events that the UPS will tolerate. <ul style="list-style-type: none"> <li>• Normal: The UPS will go on battery power more often to provide the cleanest power supply to the connected equipment.</li> <li>• Low: The UPS will tolerate more fluctuations in power and will go on battery power less often.</li> </ul> If the connected load is sensitive to power disturbances, set the sensitivity to Normal.
<b>Date of Last Battery Replacement</b>	Date set at factory. Reset this date when the battery module is replaced.		
<b>Audible Alarm</b>	On	<ul style="list-style-type: none"> <li>• On</li> <li>• Off</li> </ul>	The UPS will mute all audible alarms if this is set to <b>Off</b> or when the display buttons are pressed.
<b>Auto Self Test</b>	On start-up and every 14 days since the last test	<ul style="list-style-type: none"> <li>• Never</li> <li>• Start-up only</li> <li>• Frequency of test (every 7 to 14 days)</li> </ul>	The interval at which the UPS will execute a self-test.
<b>Reset to Factory Default</b>	No	Yes/No	Restores the UPS factory default settings.
<b>Site Wiring Fault</b>	Enable	Enable/Disable/Can Ack	Sets the Site Wiring Fault detection to Enable, Disable or User Can Acknowledge
<b>Output voltage</b>	120 V  230 V	<ul style="list-style-type: none"> <li>• 120Vac</li> <li>• 110Vac</li> <li>• 125Vac</li> <li>• 230 Vac</li> <li>• 220 Vac</li> <li>• 240 Vac</li> </ul>	Selects the output voltage. This is only settable when the UPS is turned off.
<b>Green Mode</b>	Enable	<ul style="list-style-type: none"> <li>• Enable</li> <li>• Disable</li> </ul>	This will enable or disable Green mode function. Green Mode conserves energy while the UPS is operating on line.
<b>SmartConnect Control</b>	Enable	<ul style="list-style-type: none"> <li>• Enable</li> <li>• Disable</li> </ul>	This will permit remote configuration changes.
<b>Low Battery Setting</b>	150 sec	Set the value in seconds	The UPS will emit an audible alarm when the remaining runtime has reached this level.

## Outlet group configuration settings

The Main Outlet Group and the Controlled Outlet Group can be configured to independently turn off, turn on, shut down, and reboot connected equipment.

The Main and Controlled Outlet Groups can be configured to do the following:

- Turn off: Disconnect from power immediately and restart only with a manual command.
- Turn on: Connect to power immediately.
- Shutdown: Disconnect power in sequence, and automatically reapply power in sequence when AC power becomes available.
- Reboot: Shut down and restart.

In addition, the Main Outlet Group and the Controlled Outlet Group can be configured to do the following:

- Turn on or off in a specified sequence
- Automatically turn off or shut down when various conditions occur

**NOTE:** If the Main and Controlled Outlet Groups are not configured, all of the outlets on the unit will still provide battery back-up power.

**NOTE:** The Main Outlet Group functions as a master switch. It will turn on first when power is applied, and shut off last when there is a power outage and battery run-time has been exhausted.

The Main Outlet Group must be turned on for the Controlled Outlet Group to turn on.

Setting	Factory Default	Options	Description
<b>Name String Outlet Group</b>	Outlet Group 1	Edit these names using an external interface, such as the Network Management Card Web interface.	
<b>UPS Name String</b>	UPS Outlets		
<b>Turn On Delay</b>	0 sec	Set the value in seconds	The amount of time the UPS or the Controlled Outlet Group will wait between receiving the command to turn on and the actual startup.
<b>Turn Off Delay</b>	<ul style="list-style-type: none"> <li>• 0 sec (UPS Outlets)</li> <li>• 90 sec (Controlled Outlet Groups)</li> </ul>	Set the value in seconds	The amount of time the UPS or the Controlled Outlet Group will wait between receiving the command to turn off and the actual shut down.
<b>Reboot Duration</b>	8 sec	Set the value in seconds	The amount of time that the UPS or the Controlled Outlet Group must remain off before it will restart.
<b>Minimum Return Time</b>	0 sec	Set the value in seconds	The amount of battery runtime that must be available before the UPS or the Controlled Outlet Group will turn on.
<b>Load Shed On Battery</b>	Disabled	<ul style="list-style-type: none"> <li>• Shutdown with Delay</li> <li>• Shutdown immediately</li> <li>• Turn off immediately</li> <li>• Turn off with delay</li> <li>• Disabled</li> </ul>	When the unit switches to battery power, the UPS can disconnect power to the Controlled Outlet Group to save runtime. To configure this delay time, use the LOAD SHED TIME WHEN ON BATTERY setting.
<b>Load Shed Time when On Battery</b>	Disabled	Set the value in seconds	The amount of time the outlets will function on battery power before they will turn off.
<b>Load Shed On Runtime</b>	Disabled	<ul style="list-style-type: none"> <li>• Shutdown with delay</li> <li>• Shutdown immediately</li> <li>• Turn off immediately</li> <li>• Turn off with delay</li> <li>• Disabled</li> </ul>	When the battery runtime falls below the specified value, the Controlled Outlet Group will turn off. Configure this time using the LOAD SHED RUNTIME REMAINING setting.

<b>Setting</b>	<b>Factory Default</b>	<b>Options</b>	<b>Description</b>
<b>Load Shed On Runtime Remaining</b>	Disabled	Set the value in seconds	When the remaining runtime reaches this level, the Controlled Outlet Group will turn off.
<b>Load Shed on Overload</b>	Disabled	<ul style="list-style-type: none"> <li>• Disabled</li> <li>• Enabled</li> </ul>	In the event of an overload (greater than 100% output power), the Controlled Outlet Group will immediately turn off to conserve power for essential loads. The Controlled Outlet Group will only turn on again with a manual command.

## Modbus settings

Setting	Factory Default	Options	Description
<b>Slave ID</b>	1	1- 223	Sets the Modbus slave address of UPS
<b>Ser+USB</b>	Disable	<ul style="list-style-type: none"> <li>• Enable</li> <li>• Disable</li> </ul>	Enables or disables UPS Modbus protocol over serial and USB ports
<b>TCP Settings</b> • TCP Protocols	Disable	<ul style="list-style-type: none"> <li>• Disable</li> <li>• Read-Only</li> <li>• Read-Write</li> </ul>	Enables or disables UPS Modbus TCP/IP protocol provided by the embedded SmartConnect Ethernet port. <ul style="list-style-type: none"> <li>• <b>Disable:</b> Disables UPS Modbus TCP/IP protocol</li> <li>• <b>Read-Only:</b> Modbus master over TCP/IP protocol is only allowed to get UPS status.</li> <li>• <b>Read-Write:</b> Modbus master over TCP/IP protocol is allowed to get UPS status and control the UPS.</li> </ul> The port number of UPS Modbus TCP/IP protocol is fixed at 502.
<ul style="list-style-type: none"> <li>• Master IP Addr</li> </ul>	000.000.000.000	A valid IPv4 address	Specifies the IPv4 address of the Modbus master that will allow connection to the UPS via Modbus TCP/IP protocol The <i>Master IP Addr</i> when set as 000.000.000.000 will allow connection of external Modbus master with any IP address. When not set as 000.000.000.000, only the Modbus master with the specified IP address is allowed to connect to the UPS. Example: <i>Master IP Address</i> is set to 192.168.0.10, only Modbus master with IP address 192.168.0.10 could connect to the UPS.
<b>Install FW?</b>	Don't Install	<ul style="list-style-type: none"> <li>• Next off (Updates the UPS Firmware next time that the UPS is turned off)</li> <li>• Now (Updates the UPS firmware immediately without interrupting operations)</li> <li>• Don't Install</li> </ul>	Firmware update: this only appears when new firmware is available in the flash memory of the UPS and is ready to be installed

## UPS IP Address settings

Setting	Factory Default	Options	Description
<b>UPS IP Address Mode</b>	DHCP	<ul style="list-style-type: none"> <li>• DHCP</li> <li>• Manual</li> </ul>	Selects the IP address configuration mode of UPS embedded SmartConnect Ethernet port: <ul style="list-style-type: none"> <li>• <b>DHCP:</b> UPS will automatically configure its IPv4 address via DHCP protocol.</li> <li>• <b>Manual:</b> Manually assigns a static IPv4 address to UPS</li> </ul>
<b>IP Address</b>	000.000.000.000	A valid IPv4 address	This is the IPv4 address assigned to the embedded SmartConnect Ethernet port. When <b>DHCP</b> IP address mode is selected, it will display the UPS IPv4 address assigned by DHCP server. When <b>Manual</b> IP address mode is selected, you need to manually specify a static IPv4 address.

Setting	Factory Default	Options	Description
<b>Subnet Mask</b>	000.000.000.000	A valid IPv4 subnet mask	Assigns the subnet mask of the network where UPS IPv4 address belongs. When <b>DHCP</b> IP address mode is selected, it will display the subnet mask assigned by DHCP server. When <b>Manual</b> IP address mode is selected, you need to manually specify the subnet mask of the network where the specified static IPv4 address belongs.
<b>Default Gateway</b>	000.000.000.000	A valid IPv4 address	This is the IPv4 address of the host from where the UPS sends data to another network or Internet. When <b>DHCP</b> IP address mode is selected, it will display the default gateway assigned by DHCP server. When <b>Manual</b> IP address mode is selected, you need to manually specify the IPv4 address of default gateway.
<b>DNS Server 1</b>	000.000.000.000	A valid IPv4 address	The IPv4 address of first domain name server (DNS) the UPS uses to resolve host names to IPv4 addresses. When <b>DHCP</b> IP address mode is selected, it will display the IPv4 address of the first DNS server assigned by DHCP server. When <b>Manual</b> IP address mode is selected, you need to manually specify the IPv4 address of the first DNS server.
<b>DNS Server 2</b>	000.000.000.000	A valid IPv4 address	The IPv4 address of second domain name server (DNS) the UPS uses to resolve host names to IPv4 addresses ( <i>only when UPS is not able to resolve IP address through first domain name server</i> ). This setting is optional. When <b>DHCP</b> IP address mode is selected, it will display the IPv4 address of the second DNS server assigned by DHCP server. When <b>Manual</b> IP address mode is selected, you can manually specify the IPv4 address of the second DNS server or leave it as 000.000.000.000.

### Network Management Card Settings

These settings are available only on units that have a Network Management Card (NMC) and are set in the factory. These settings can only be modified using an external interface, like the NMC web interface.

- NMC IP Address Mode
- NMC IP Address
- NMC Subnet Mask
- NMC Default Gateway

# SmartConnect

SmartConnect Ethernet Port allows you to monitor the health and status of your UPS from any device connected to the Internet. Availability of features varies by terms of use. Access the terms of use at <https://smartconnect.apc.com>.

Refer to “EcoStruxure™ IT SmartConnect” below for details.

## EcoStruxure™ IT SmartConnect

The Web Portal allows you to remotely view the status of your UPS, receive automatic notifications about UPS events, and firmware updates. The features may vary with terms of use. Visit [smartconnect.apc.com](https://smartconnect.apc.com) to learn more.

By connecting this product to the Internet using the SmartConnect Ethernet port, you are agreeing to the APC SmartConnect Terms of Use and Data Privacy Notice, as found at [smartconnect.apc.com/terms-and-privacy](https://smartconnect.apc.com/terms-and-privacy). The Schneider Electric Data Privacy Policy can also be found at [smartconnect.apc.com/terms-and-privacy](https://smartconnect.apc.com/terms-and-privacy).

Log onto [smartconnect.apc.com](https://smartconnect.apc.com) or scan the QR code to begin the registration process. The QR code is located on the rear panel of the UPS.

For instructions on how to register your SmartConnect-compatible UPS, visit [smartconnect-support.apc.com](https://smartconnect-support.apc.com).

## Emergency Power Off

### Overview

The Emergency Power Off (EPO) option is a feature that will immediately shut off power to all connected equipment. When the EPO button is pushed, all connected equipment will immediately turn off and will not switch to battery power.

Connect each UPS to the EPO switch. In configurations where multiple units are connected in parallel, each UPS must be connected to the EPO switch.

The UPS must be restarted for power to return to connected equipment. Press the ON/OFF button on the front panel of the UPS.

### CAUTION

#### RISK OF ELECTRIC SHOCK

- Adhere to all local and national electrical codes.
- Wiring should be performed by a qualified electrician.
- Always connect the UPS to a grounded outlet.

**Failure to follow these instructions can result in minor or moderate injury.**

### Normally open contacts

1. If the EPO switch or relay contacts are normally open, insert the wires from the switch or contacts at pins 1 and 2 of the EPO terminal block. Use 16-28 AWG wire.
2. Secure the wires by tightening the screws.

If the contacts are closed, the UPS will turn OFF and power will be removed from the load.

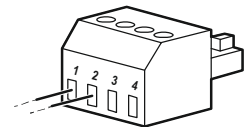

### Normally closed contacts

1. If the EPO switch or relay contacts are normally closed, insert the wires from the switch or contacts at pins 2 and 3 of the EPO terminal block. Use 16-28 AWG wire.
2. Insert a wire jumper between pins 1 and 2. Secure the wires by tightening the three screws at positions 1, 2, and 3.

If the contacts are opened, the UPS will turn OFF and power will be removed from the load.

**NOTE:** Pin 1 is the power source for the EPO circuit, it provides a few milliAmps of 24 V power.

If the normally closed (NC) EPO configuration is used, the EPO switch or relay should be rated for dry circuit applications, the rating should be for low voltage and low current applications. This normally implies the contacts are gold plated.

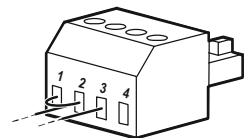



The EPO interface is a Safety Extra Low Voltage (SELV) circuit. Connect the EPO interface only to other SELV circuits. The EPO interface monitors circuits that have no determined voltage potential. SELV circuits are controlled by a switch or relay properly isolated from utility power. To avoid damage to the UPS, do not connect the EPO interface to any circuit other than a SELV circuit.

Use one of the following cable types to connect the UPS to the EPO switch.

- CL2: Class 2 cable for general use.
- CL2P: Plenum cable for use in ducts, plenums, and other spaces used for environmental air.
- CL2R: Riser cable for use in a vertical run in a floor-to-floor shaft.
- CLEX: Limited use cable for use in dwellings and for use in raceways.
- Installation in Canada: Use only CSA certified, type ELC, (extra low voltage control cable).
- Installation in countries other than Canada and the USA: Use standard low voltage cable in accordance with national and local regulations.

## Battery Replacement

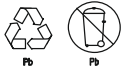

**Always recycle used batteries.**

**For information on recycling a used battery, refer to the Battery Disposal Information sheet included with the replacement battery.**

Battery life is highly dependent on temperature and use. To identify when to replace batteries, Smart-UPS have a predictive battery replacement date indicator in the “About” menu and automatic (and configurable) self-tests.

Proactively replace batteries to maintain the highest availability. To ensure protection and high performance, use only genuine APC replacement battery cartridges (RBC™). The APC RBC contains instructions for battery replacement and disposal. To order a replacement battery go to the APC by Schneider Electric Web site, [www.apc.com](http://www.apc.com).

UPS Model	Replacement Battery	Battery Module
SMT750C, SMT750IC	RBC48	Lead acid, 1 module, 24Vdc
SMT1000C, SMT1000IC	RBC6	
SMT1500C, SMT1500CNC, SMT1500IC	RBC7	
SMT2200C, SMT2200IC, SMT3000C, SMT3000IC	RBC55	Lead acid, 2 modules, 48Vdc
SMT750RM2UC, SMT750RM2UCNC, SMT750RMI2UC	APCRBC123	Lead acid, 1 module, 24Vdc
SMT1000RM2UC, SMT1000RMI2UC	APCRBC157	
SMT1500RM2UC, SMT1500RM2UCNC, SMT1500RMI2UC	APCRBC159	
SMT2200RM2UC, SMT2200RM2UCNC, SMT2200RMI2UC, SMT3000RM2UC, SMT3000RM2UCNC, SMT3000RMI2UC	RBC43	Lead acid, 1 module, 48Vdc

# Troubleshooting

<b>Problem and Possible Cause</b>	<b>Solution</b>
<b>The UPS will not turn on or there is no output.</b>	
The unit has not been turned on.	Press the UPS ON/OFF key once to turn on the UPS.
The UPS is not connected to AC power.	Be sure the power cable is securely connected to the unit and to the AC power supply.
The input circuit breaker has tripped.	Reduce the load on the UPS. Disconnect nonessential equipment and reset the circuit breaker.
The unit shows very low or no input AC voltage.	Check the AC power supply to the UPS by plugging in a table lamp. If the light is very dim, check the AC voltage.
The battery connector plug is not securely connected.	Be sure that all battery connections are secure.
There is an internal UPS error detected.	Do not attempt to use the UPS. Unplug the UPS and have it serviced immediately.
<b>The UPS is operating on battery, while connected to input AC power.</b>	
The input circuit breaker has tripped.	Reduce the load on the UPS. Disconnect nonessential equipment and reset the circuit breaker.
There is very high, very low, or distorted input line voltage.	Move the UPS to a different outlet on a different circuit. Test the input voltage with the AC voltage display. If acceptable to the connected equipment, reduce the UPS sensitivity.
<b>UPS is emitting intermittent beeps.</b>	
The UPS is operating normally.	None. The UPS is helping to protect the connected equipment.
<b>UPS does not provide expected backup time.</b>	
The UPS battery is weak due to a recent power outage or is near the end of its service life.	Charge the battery. Batteries require recharging after extended outages and wear out faster when put into service often or when operated at elevated temperatures. If the battery is near the end of its service life, consider replacing the battery even if the replace battery indicator has not illuminated.
The UPS is experiencing an overload condition.	Check the UPS load display. Unplug unnecessary equipment, such as printers.
<b>Display interface LEDs flash sequentially.</b>	
The UPS has been shut down remotely through software or an optional accessory card.	None. The UPS will restart automatically when AC power is restored.
<b>The Error LED is illuminated. The UPS displays an error message and emits a constant beeping sound.</b>	
Internal UPS error detected.	Do not attempt to use the UPS. Turn the UPS off and have it serviced immediately.
<b>The Replace Battery icon is illuminated and the UPS beeps for one minute every five hours.</b>	
The battery has a weak charge.	Allow the battery to recharge for at least four hours. Then, perform a self-test. If the problem persists after recharging, replace the battery.
<b>The Replace Battery icon is flashing and the UPS beeps for once every 2 seconds.</b>	
The replacement battery is not properly connected.	Be sure that the battery connector is securely connected.
<b>The UPS displays a site wiring error message.</b>	
Wiring errors detected include missing ground, hot-neutral, polarity reversal, and overloaded neutral circuit.	If the UPS indicates a site wiring error, have a qualified electrician inspect the building wiring. (Applicable for 120 V units only.)

# Limited Factory Warranty

Schneider Electric IT Corporation (SEIT), warrants its products to be free from defects in materials and workmanship for a period of three (3) years excluding the batteries, which are warranted for two (2) years from the date of purchase. The SEIT obligation under this warranty is limited to repairing or replacing, at its own sole option, any such defective products. Repair or replacement of a defective product or parts thereof does not extend the original warranty period.

This warranty applies only to the original purchaser who must have properly registered the product within 10 days of purchase. Products may be registered online at [warranty.apc.com](http://warranty.apc.com).

SEIT shall not be liable under the warranty if its testing and examination disclose that the alleged defect in the product does not exist or was caused by end user's or any third person's misuse, negligence, improper installation, testing, operation or use of the product contrary to SEIT's recommendations or specifications. Further, SEIT shall not be liable for defects resulting from: 1) unauthorized attempts to repair or modify the product, 2) incorrect or inadequate electrical voltage or connection, 3) inappropriate on site operation conditions, 4) Acts of God, 5) exposure to the elements, or 6) theft. In no event shall SEIT have any liability under this warranty for any product where the serial number has been altered, defaced, or removed.

EXCEPT AS SET FORTH ABOVE, THERE ARE NO WARRANTIES, EXPRESS OR IMPLIED, BY OPERATION OF LAW OR OTHERWISE, APPLICABLE TO PRODUCTS SOLD, SERVICED OR FURNISHED UNDER THIS AGREEMENT OR IN CONNECTION HEREWITH.

SEIT DISCLAIMS ALL IMPLIED WARRANTIES OF MERCHANTABILITY, SATISFACTION AND FITNESS FOR A PARTICULAR PURPOSE.

SEIT EXPRESS WARRANTIES WILL NOT BE ENLARGED, DIMINISHED, OR AFFECTED BY AND NO OBLIGATION OR LIABILITY WILL ARISE OUT OF, SEIT'S RENDERING OF TECHNICAL OR OTHER ADVICE OR SERVICE IN CONNECTION WITH THE PRODUCTS.

THE FOREGOING WARRANTIES AND REMEDIES ARE EXCLUSIVE AND IN LIEU OF ALL OTHER WARRANTIES AND REMEDIES. THE WARRANTIES SET FORTH ABOVE CONSTITUTE SEIT'S SOLE LIABILITY AND PURCHASER'S EXCLUSIVE REMEDY FOR ANY BREACH OF SUCH WARRANTIES. SEIT WARRANTIES EXTEND ONLY TO ORIGINAL PURCHASER AND ARE NOT EXTENDED TO ANY THIRD PARTIES.

IN NO EVENT SHALL SEIT, ITS OFFICERS, DIRECTORS, AFFILIATES OR EMPLOYEES BE LIABLE FOR ANY FORM OF INDIRECT, SPECIAL, CONSEQUENTIAL OR PUNITIVE DAMAGES, ARISING OUT OF THE USE, SERVICE OR INSTALLATION OF THE PRODUCTS, WHETHER SUCH DAMAGES ARISE IN CONTRACT OR TORT, IRRESPECTIVE OF FAULT, NEGLIGENCE OR STRICT LIABILITY OR WHETHER SEIT HAS BEEN ADVISED IN ADVANCE OF THE POSSIBILITY OF SUCH DAMAGES. SPECIFICALLY, SEIT IS NOT LIABLE FOR ANY COSTS, SUCH AS LOST PROFITS OR REVENUE, WHETHER DIRECT OR INDIRECT, LOSS OF EQUIPMENT, LOSS OF USE OF EQUIPMENT, LOSS OF SOFTWARE, LOSS OF DATA, COSTS OF SUBSTITUANTS, CLAIMS BY THIRD PARTIES, OR OTHERWISE.

NOTHING IN THIS LIMITED WARRANTY SHALL SEEK TO EXCLUDE OR LIMIT SEIT'S LIABILITY FOR DEATH OR PERSONAL INJURY RESULTING FROM ITS NEGLIGENCE OR ITS FRAUDULENT MISREPRESENTATION OF TO THE EXTENT THAT IT CANNOT BE EXCLUDED OR LIMITED BY APPLICABLE LAW.

To obtain service under warranty you must obtain a Returned Material Authorization (RMA) number from customer support. Customers with warranty claims issues may access the SEIT worldwide customer support network through the SEIT Web site: [www.apc.com](http://www.apc.com). Select your country from the country selection drop down menu. Open the Support tab at the top of the web page to obtain information for customer support in your region. Products must be returned with transportation charges prepaid and must be accompanied by a brief description of the problem encountered and proof of date and place of purchase.

# Transport the Unit

1. Shut down and disconnect all connected equipment.
2. Disconnect the unit from utility power.
3. Disconnect all internal and external batteries (if applicable).
4. Follow the shipping instructions outlined in the *Service* section of this manual.

## Service

If the unit requires service, do not return it to the dealer. Follow these steps:

1. Review the *Troubleshooting* section of the manual to eliminate common problems.
2. If the problem persists, contact APC Customer Support through the APC web site, **www.apc.com**.
  - a. Note the model number and serial number and the date of purchase. The model and serial numbers are located on the rear panel of the unit and are available through the LCD interface on select models.
  - b. Call APC Support and a technician will attempt to solve the problem over the phone. If this is not possible, the technician will issue a Returned Material Authorization Number (RMA#).
  - c. If the unit is under warranty, it will be repaired or replaced at no cost.
  - d. Service procedures and returns may vary internationally. Refer to the APC web site for country specific instructions.
3. Before shipping, always disconnect all battery modules in a UPS or external battery pack.
4. Pack the unit properly to avoid damage in transit. Never use foam beads for packaging. Damage sustained in transit is not covered under warranty.
5. Write the RMA# provided by Customer Support on the outside of the package.
6. Return the unit by insured, prepaid carrier to the address provided by Customer Support.



# APC by Schneider Electric Worldwide Customer Support

Customer support for this or any other APC by Schneider Electric product is available at no charge in any of the following ways:

- Visit the APC by Schneider Electric web site to access documents in the APC by Schneider Electric Knowledge Base and to submit customer support requests.
  - **www.apc.com** (Corporate Headquarters)  
Connect to localized APC by Schneider Electric web sites for specific countries, each of which provides customer support information.
  - **www.apc.com/support/**  
Global support searching APC by Schneider Electric Knowledge Base and using e-support.
- Contact the APC by Schneider Electric Customer Support Center by telephone or e-mail.
  - Local, country specific centers: go to **www.apc.com/support/contact** for contact information.
  - For information on how to obtain local customer support, contact the APC by Schneider Electric representative or other distributor from whom you purchased your APC by Schneider Electric product.



Select models are ENERGY STAR® qualified.

For more information on your specific model go to [www.apc.com](http://www.apc.com).

© 2023 APC by Schneider Electric. APC, the APC logo, PowerChute and Smart-UPS are owned by Schneider Electric Industries S.A.S. or their affiliated companies. All other trademarks are property of their respective owners.