

ASSEMBLY INSTRUCTION

BENCH

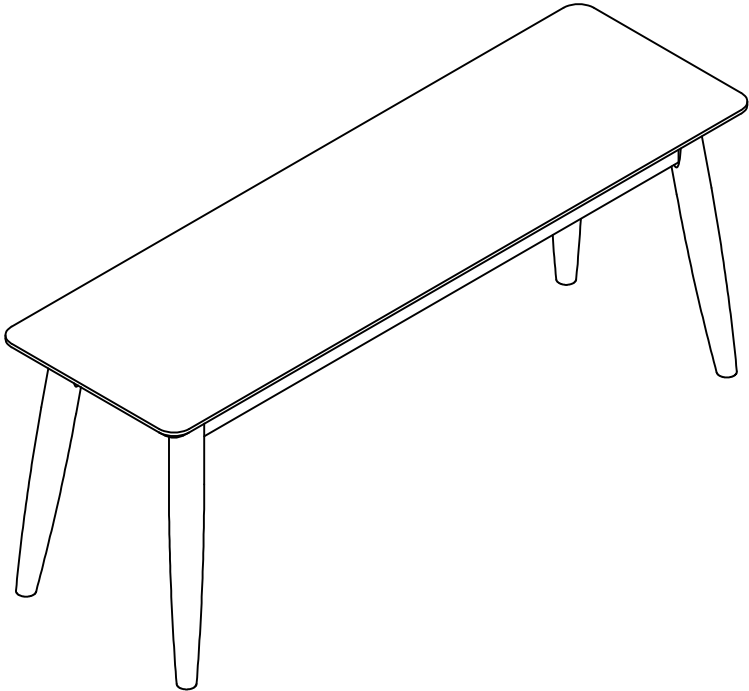

REPLACEMENT PARTS

Please do not contact the company purchased from as we can help you faster.
Order replacement parts and hardware at "www.boltonfurniture.com"

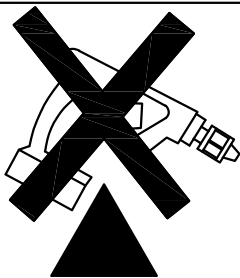

- . Use of power tool to assemble this product will invalidate any claim and damage this product making it unsafe !!!
- . Please assemble on a clean soft surface to avoid damage.

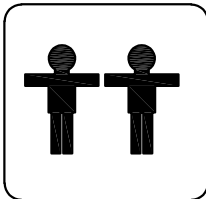

30 minutes

Tools Required

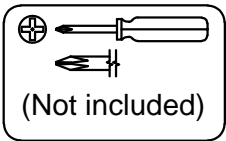
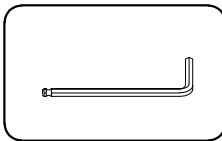

(Not included)

Part list - Bench

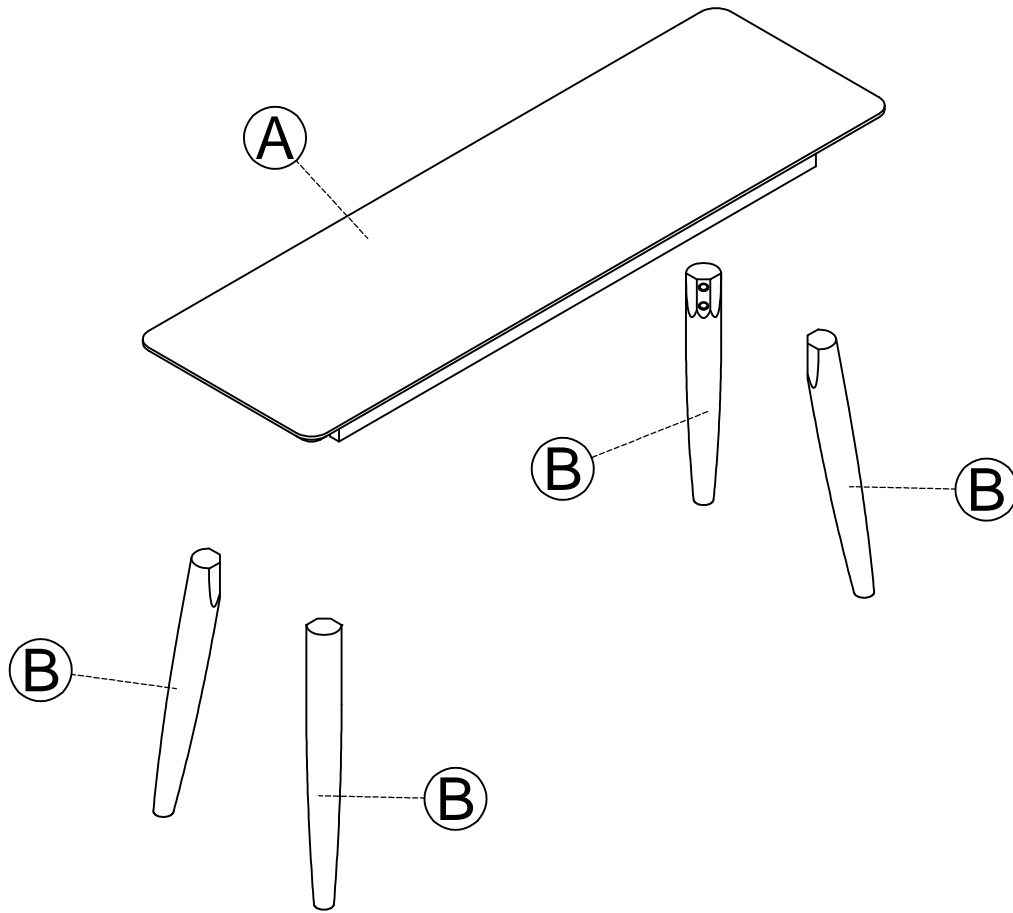

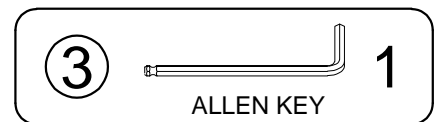
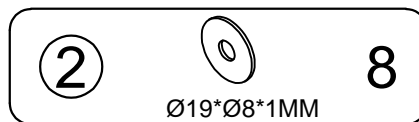
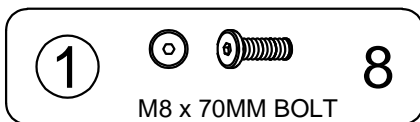

QTY			
(A)	1	(B)	4

Identifying the hardware-*Identify the hardware using the illustrations below*



ASSEMBLY DESCRIPTION

STEP 1

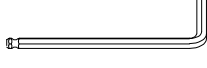
- | | | |
|----------------|---|---|
| ① |  | 8 |
| M8 x 70MM BOLT | | |
| ② |  | 8 |
| Ø19*Ø8*1MM | | |
| ③ |  | 1 |
| ALLEN KEY | | |

