

# SONANCE

## PS-C85RT HIGH OUTPUT LOUDSPEAKER

### PROFESSIONAL SERIES DATA SHEET

#### PROFESSIONAL SERIES HIGH OUTPUT LOUDSPEAKERS

The Professional Series High Output Loudspeakers deliver elevated SPL, controlled dispersion, and clear speech intelligibility in demanding commercial environments. Each model pairs an 8-inch low-frequency driver with a 1.4-inch coaxially mounted compression driver, enabling the series to handle foreground music and open microphone applications with extended low-frequency response down to 41 Hz — often eliminating the need for subwoofers and reducing system complexity.

#### APPLICATIONS

- Sports bars and high energy hospitality venues
- Nightclubs and upscale lounges
- Event venues and ballrooms
- Fitness studios and large commercial spaces
- High ceiling environments with challenging acoustics

The advanced Variable Dispersion technology allows installers to fine tune coverage patterns, targeting specific audience zones with precision, to address challenging acoustic spaces while maintaining consistent sound quality. Optional mounting accessories and finish options offer flexible installation and design matching

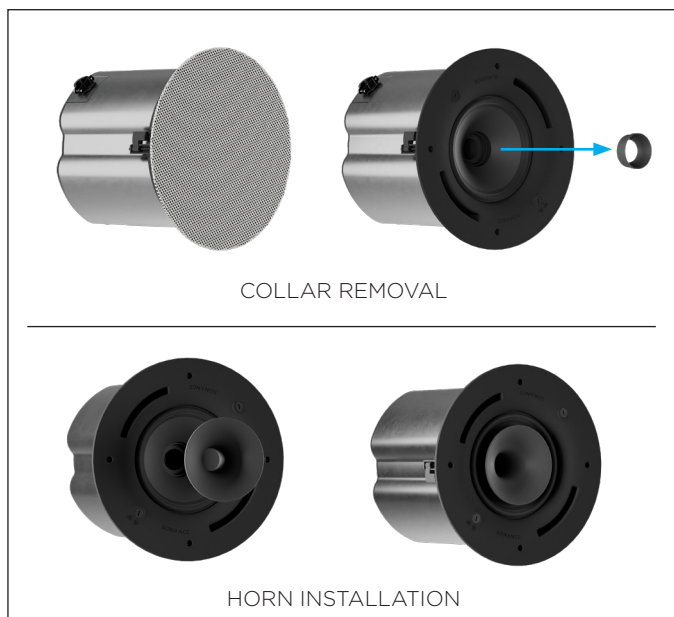

#### FEATURES AND BENEFITS

##### IMMERSIVE POWER

8" woofer with 1.4" coaxially mounted compression driver handles foreground music, open microphones, and high-dynamic-range applications, delivering unmatched clarity and coverage.

##### VARIABLE DISPERSION

Magnetically attached horn and collar assembly provides 120° or 80° coverage options, is field-adjustable without special tools, and includes a two-position switch that optimizes the crossover for each configuration.

##### INSTALLATION VERSATILITY

Available in Surface, Pendant, Blind Mount In-ceiling, and Two-piece In-ceiling Pre-install System — all with identical tonal character for seamless mix-and-match deployment.

#### INCLUDED ACCESSORIES

- Round Grille
- Screw-On Top Cover
- Euroblock Wire Connector
- Variable Dispersion Horn
- Collar Claw Removal Tool
- C-Bracket and Tile Bridge

#### OPTIONAL ACCESSORIES

- Replacement White Grille (PR) | 40239
- Replacement Black Grille (PR) | 40240
- Square Adaptor White Grille (PR) | 40241
- Square Adaptor Black Grille (PR) | 40242
- Square Adaptor White Grille (5 PR) | 40243
- Square Adaptor Black Grille (5 PR) | 40244
- Metal Rough-in Bracket (6 PR) | 40279
- Replacement C-Bracket and Tile Bridge (EA) | 40230

# TECHNICAL SPECIFICATIONS

## PS-C85RT HIGH OUTPUT LOUDSPEAKER

SKU	40229
Color	Ships with White Round Grille - RAL 9003

## TRANSDUCERS

LF Driver	8" (203mm) aluminum cone, Santoprene surround, 60.55mm Voice Coil Size, Ferrite Magnet
HF Driver	1.4" (36mm) aluminum dome compression driver, 36mm Voice Coil Size, 1" (25mm) Exit Size, Neodymium Magnet, 1500Hz Crossover Frequency

## PERFORMANCE SPECIFICATIONS

Frequency Range (-10dB)	39.8Hz - 25kHz
Frequency Range (-3dB)	53.3Hz - 20kHz
Nominal Sensitivity	93 dB SPL
Long Term Power Handling (IEC)	150 watts (600 Watts Peak), 100 Hours
Program Power	300 watts (1200 Watts Peak), 2 Hours
Long Term - Maximum SPL	114dB (120dB Peak)
Program Power - Maximum SPL	117dB (123dB Peak)
Rated Impedance	8 ohms bypass

## ACOUSTIC SPECIFICATIONS

Coverage Pattern 1kHz to 10kHz	120° or 80° Axis Symmetric
Collar Directivity Factor (Q)	5.7dB (Average 1kHz to 16kHz)
Horn Directivity Factor (Q)	8.65dB (Average 1kHz to 16kHz)
Collar Directivity Index (DI)	7.5dB (Average 1kHz to 16kHz)
Horn Directivity Index (DI)	9dB (Average 1kHz to 16kHz)

## ELECTRICAL SPECIFICATIONS

Transformer Taps (70V)	120W, 60W, 30W, 15W (8 ohm bypass)
Transformer Taps (100V)	120W, 60W, 30W (8 ohm bypass)
Input Connector	Four pin, Euroblock with loop output connections

## ENCLOSURE DETAILS

Enclosure Material	Steel, Powder coated
Baffle Material	PC/ABS (UL94V-0)
Grille Material	Steel
Suspension Points	Two, on top surface
Enclosure/Port Tuning	54.6Hz
Standards Compliance	UL 1480A, UL 2043, NFPA 90A, NFPA 70

## PHYSICAL DIMENSIONS

Overall Dimension (Dia x D)	13.27" x 10.82" (337mm x 274.8mm)
Cut Out Dimension (Dia)	11.625" (296mm)
Mounting Depth	10.7" (271.8mm)
Round Trimless Grille (Dia)	13.32" (338.4mm)
Square Trimless Grille (WxH)	13.38" x 13.38" (339.8mm x 339.8mm)
Capture Thickness	0" to 2.12" (0mm to 53.84mm)

## WEIGHT SPECIFICATIONS

Shipping Weight (Pair)	79.47 lbs. (36.04kg)
Net Weight w/ Grille	26.04 lbs (11.81kg)

## ENVIRONMENTAL SPECIFICATIONS

Operating Temperature Range	-40 F to 140 F (-39.96 C to 60 C)
IP Rating	N/A

# PS-C85RT GRAPHS

## COLLAR DIRECTIVITY

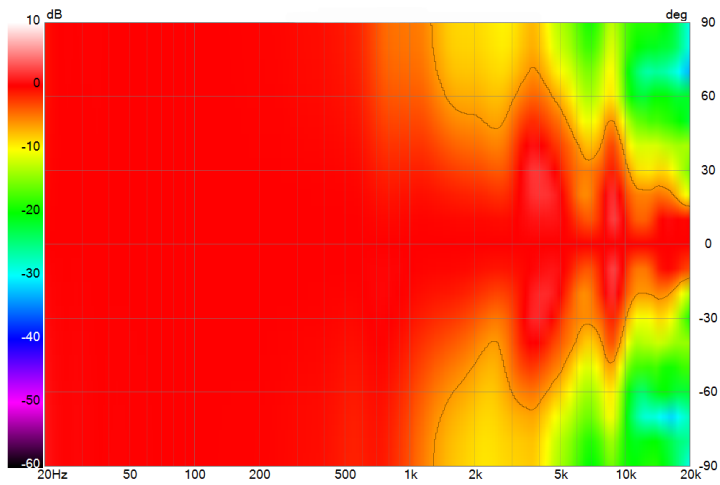

## HORN DIRECTIVITY

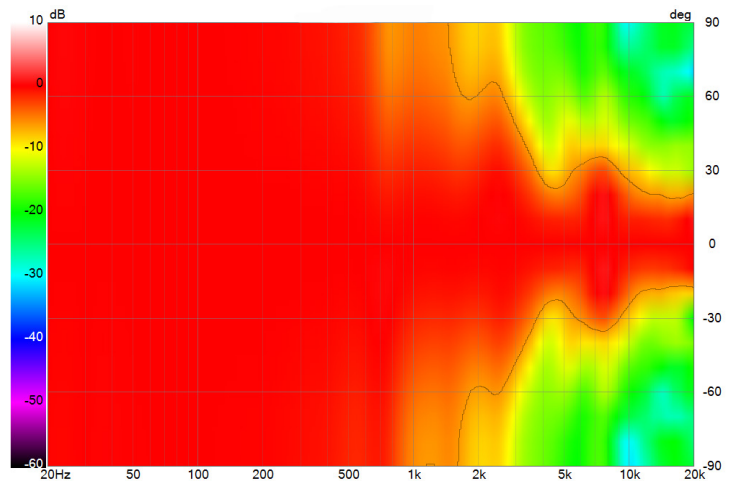

## COLLAR IMPEDANCE

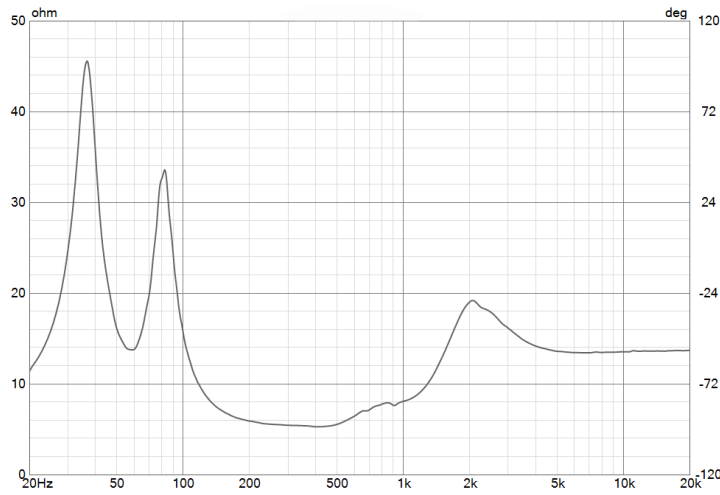

## HORN IMPEDANCE

— Generator Load impedance

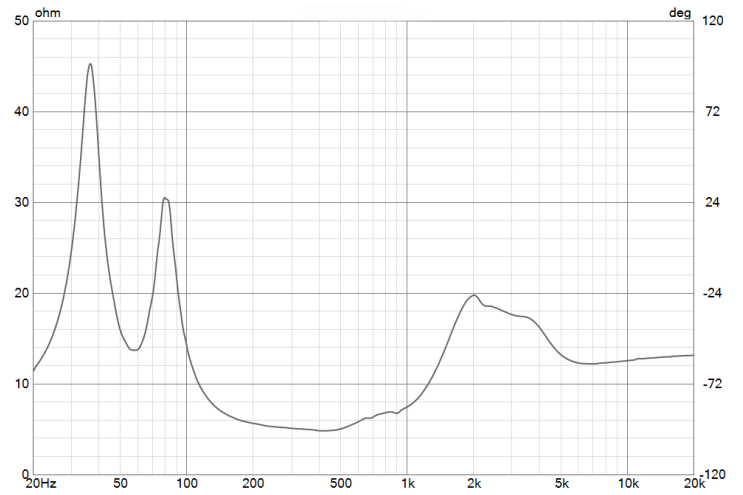

## COLLAR SPL

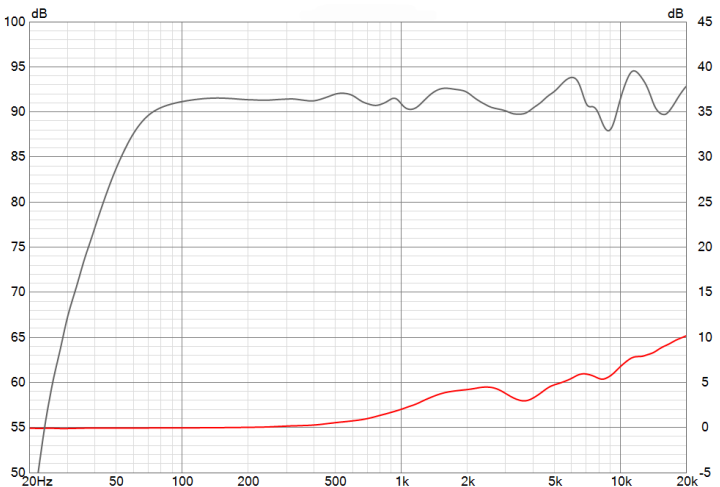

## HORN SPL

— On-axis  
— Sound Power DI

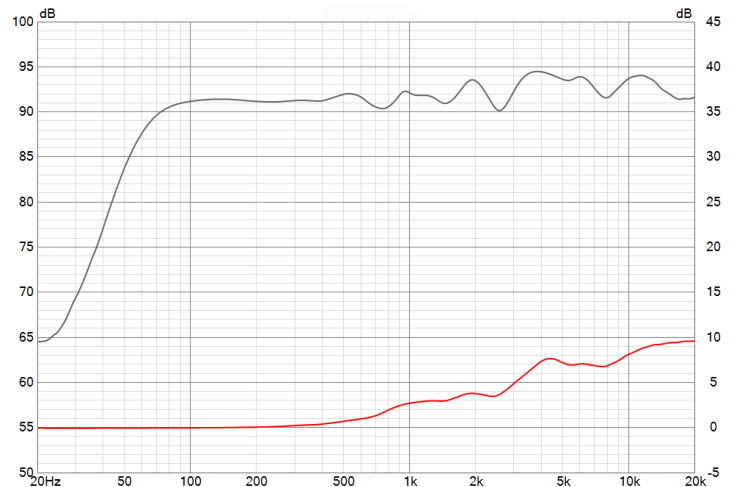

# DIMENSIONAL SKETCHES SPECIFICATIONS

## PS-C85RT High Output Loudspeaker

Diameter: 13.27" (337mm)

Depth: 10.7" (271.8mm)

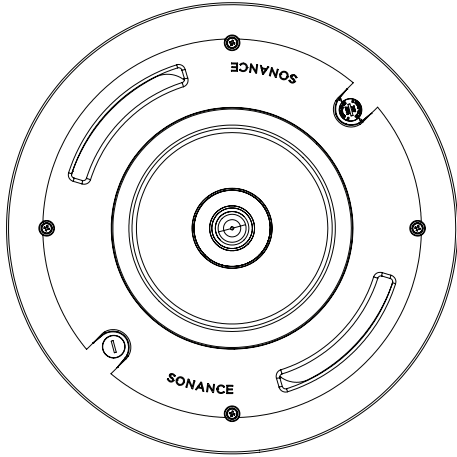

Loudspeaker Front  
13.27" (337mm)

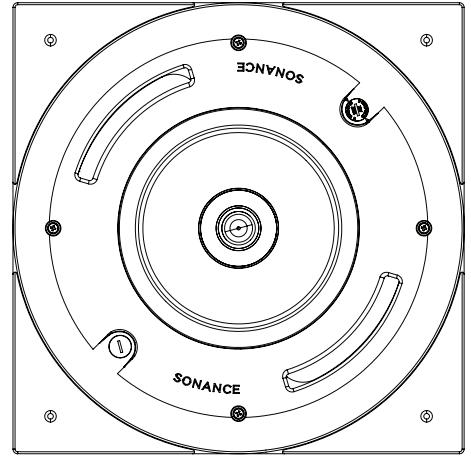

Loudspeaker Square Adapter Front  
13.27" x 13.27" (337mm x 337mm)

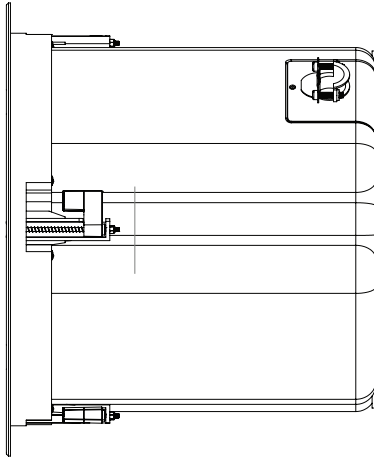

Loudspeaker Side  
10.7" (271.8mm)

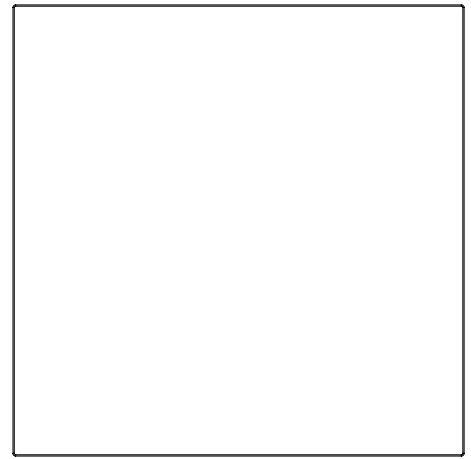

Square Grille Front  
13.38" x 13.38" (339.8mm x 339.8mm)

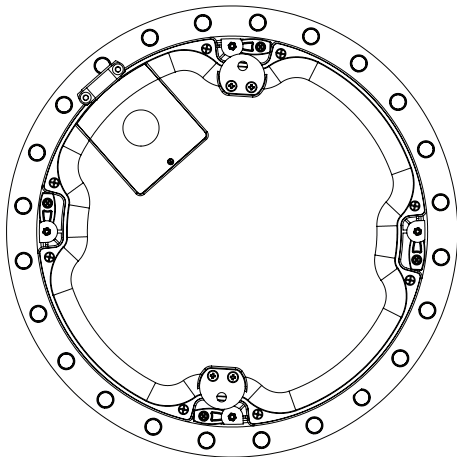

Loudspeaker Back  
11.5" (292mm)

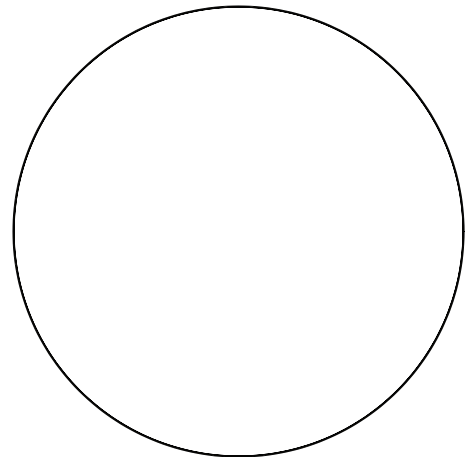

Round Grille Front  
13.32" (338.4mm)

## ARCHITECTURAL SPECIFICATIONS

### 70V/100V/8 ohm Selectable 8" In-Ceiling Speaker

The loudspeaker shall be of the two-way type comprising a single flush mount in-ceiling enclosure containing one 8" (203mm) aluminum cone, santoprene surround low frequency transducer with ferrite magnet and 60.55mm voice coil, and one 1.4" (36mm) coaxially mounted aluminum dome compression driver high frequency transducer with neodymium magnet, 36mm voice coil, and 1" (25mm) exit with 1500Hz crossover frequency. It shall feature interchangeable collar and horn directivity options for flexible coverage patterns. Frequency range shall be 53.3Hz - 20KHz (+/-3dB). Long term power handling shall be 150 Watts continuous (600 Watts Peak) for 100 hours per IEC standards, with program power of 300 Watts (1200 Watts Peak) for two hours. The unit shall be supplied with a laminated core line matching transformer suitable for 100 volt or 70 volt with control allowing user selectable power taps of 120W, 60W, 30W, and 15W (70V), 120W, 60W, and 30W (100V), and an 8 ohm bypass. The enclosure shall be constructed from powder coated steel with ABS plastic (UL94V-0) baffle suitable for indoor applications. The grille shall be constructed from steel with round or square trim options. The speaker shall be suitable for commercial installation per UL 1480A, UL 2043, NFPA 90A, and NFPA 70 standards for use in air handling spaces. Wire shall be terminated via four pin Euroblock connector with loop output connections. Two suspension points shall be provided on the top surface to allow additional support when necessary. The enclosure cubic volume shall be 0.48 cubic feet (13.5 cubic liters) with port tuning at 54.6Hz. The system shall include support components for installation with capture thickness capability from 0" to 2.12" (0mm to 53.84mm). Coverage pattern from 1kHz to 10kHz shall be 120 degrees axis symmetric (collar configuration) or 80 degrees axis symmetric (horn configuration) with directivity factor (Q) of 5.7 (collar) or 8.65 (horn) averaged from 1kHz to 16kHz and directivity (DI) of 7.5dB (collar) or 9dB (horn) averaged from 1kHz to 16kHz. Operating temperature range shall be -40°F to 140°F (-40°C to 60°C). External dimensions shall be 13.27" Diameter x 10.82" Depth (337mm x 274.8mm) with mounting depth of 10.7" (271.8mm) and cut out dimension of 11.625" diameter (296mm). Round trimless grille diameter shall be 13.32" (338.4mm) with optional square trimless grille of 13.38" x 13.38" (339.8mm x 339.8mm). The total enclosure shall weigh 26.04 lbs. (11.81 kg) per unit with grille. It shall have fire-rated engineering and accurate sonic performance to deliver both good intelligibility and musicality suitable for commercial ceiling installations. The loudspeaker shall be the Sonance Professional Series PS-C85RT. No other system shall be acceptable unless the above combined performance specifications are equaled or exceeded.

## SAFETY AGENCY COMPLIANCE

Sonance Professional Series model PS-C85RT meets the following standards:

**UL-1480A:** Speakers for Commercial and Professional use

**UL-2043:** Fire test for heat and visible smoke release for discrete products and their accessories installed in air handling spaces

**CSA-C22.2 No.205:** Signal equipment shall be installed in accordance with:

**NFPA-70:** National Electric Code

**NFPA-90A:** Installation of Air Conditioning and Ventilation

**CSA C22.1:** Canadian Electrical Code



## TECHNICAL ASSISTANCE AND SERVICE

For Technical Assistance, call (949) 492-7777 for any questions concerning the speaker operation and installation between the hours of 7:00AM - 5:00PM (Pacific), Monday through Friday, except holidays. In the event your unit should need repair or service, you may return the unit to your authorized dealer or use the following guidelines: **PLEASE KEEP ORIGINAL PACKAGING WHEN POSSIBLE.**

1. Be prepared to state the model number and/or serial number, date of purchase, dealer's name and address.
2. Contact Sonance directly at (949) 492-7777 or at [www.sonance.com](http://www.sonance.com). **YOU MUST HAVE PRIOR AUTHORIZATION TO RETURN YOUR UNIT.**
3. If you are returning the product directly to Sonance, call us to obtain a return authorization number before shipping.
4. Ship the product via United Parcel Service, Federal Express, or other package delivery service. Please do not use the U.S. Postal Service.
5. Include the return authorization number on the shipping label.
6. Ship to:

Attn: Quality Assurance Department, RMA# (include RMA number here)  
Sonance

11016 Mulberry Ave., Suite B  
Fontana, CA 92337

# WARRANTY, REMEDY, EXCLUSIONS AND LIMITATIONS (USA ONLY)

## LIMITED WARRANTY

Sonance warrants this product to the original purchaser to be free from defects in material and workmanship, under normal use and conditions, for a period of five (5) years from the date of original purchase as shown on the invoice. The foregoing exclusive warranty gives you specific legal rights, and you may have other rights, which vary from state to state. This warranty applies exclusively to the original purchaser.

The exclusive warranty does not apply and is ineffective if:

1. The invoice fails to establish that the product was purchased from an authorized Sonance dealer or distributor;
2. The product was subjected to misuse, neglect, accident, or improper installation.  
(Damage to the product was caused by accident, abuse or misuse);
3. The product was modified, altered, or repaired by unauthorized personnel; or
4. The unit was not used as described in the installation and operating instructions.

## EXCLUSIVE REMEDY

Sonance agrees, at its option during the five (5) year warranty period, to repair any defect in material or workmanship or to furnish an equal product in exchange without charge to the purchaser, subject to the verification of the defect and proof of the date of purchase.

## WARRANTY EXCLUSIONS AND DAMAGE LIMITATIONS

The exclusive warranty set forth above is in lieu of all other warranties, express or implied, including without limitation the implied warranties of merchantability and fitness for a particular purpose, which are expressly disclaimed. In no event, and under no circumstances or legal or equitable theory, shall Sonance be liable or responsible for any direct or indirect damages, consequential damages, loss, or injury, including without limitation, personal injury, bodily injury, property damage, emotional distress, death, real property or personal property damage, business interruption, costs of delay or lost profits arising from the product, whether based upon warranty, contract, negligence, strict product liability or other theory.