



New
Classic[®]
FURNITURE

ASSEMBLY INSTRUCTIONS

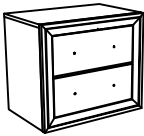

B0182-040 BALLARD 2 DRAWER NIGHTSTAND

Thank you for purchasing this quality product. Be sure to check all packing materials carefully for small parts, which may have come loose inside the carton during shipment. Identify and count all items and compare with the parts list and/or hardware list shown.

PARTS LIST

NO	COMPONENT	DRAWING	QTY
A	Nightstand		1 pc
B	Leg		4 pcs

HARDWARE LIST

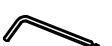
NO	COMPONENT	DRAWING	QTY
1	JCBC M6 x 2" Blk		4 pcs
2	Spring Washer 1/4" Blk		4 pcs
3	Flat Washer 1/4"IDx4/8"OD Blk		4 pcs
4	Allen Key M4 x 4 3/8 " Blk		1 pc

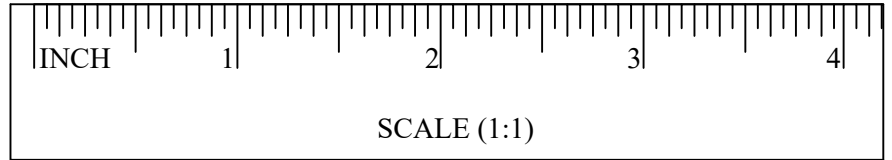

STEP 1 : Locate the Legs (B) from the bottom drawer of the Nightstand (A).

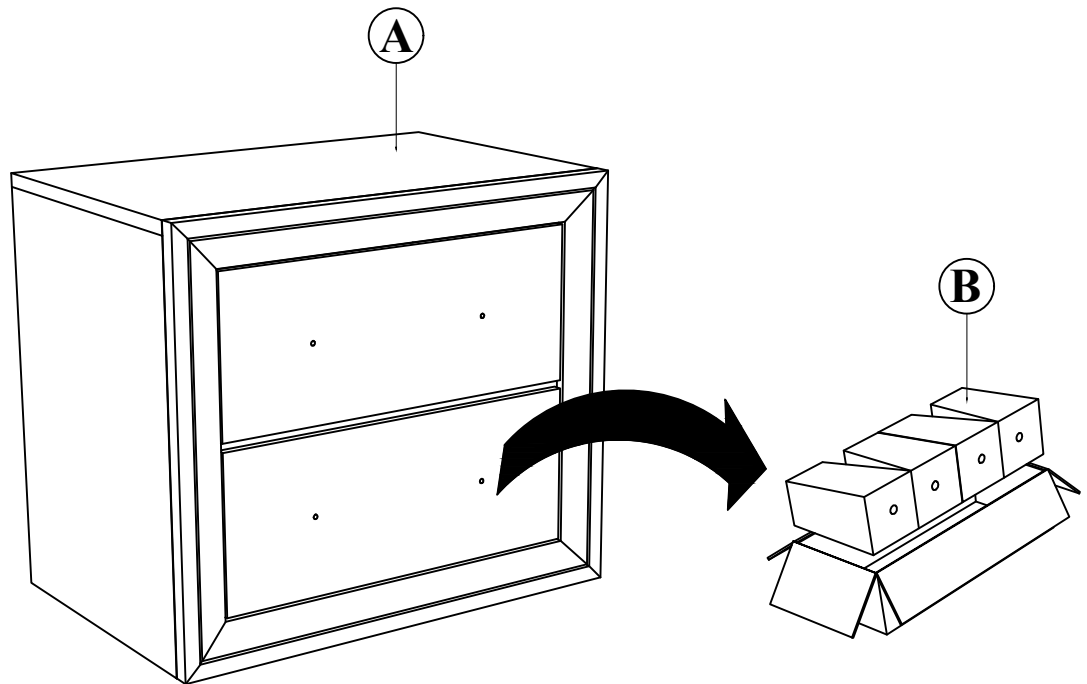

STEP 2 : Place the Nightstand (A) upside down on a flat and clean surface. Assemble the Leg (B) by using Allen Key (4) with hardware 1, 2, and 3.

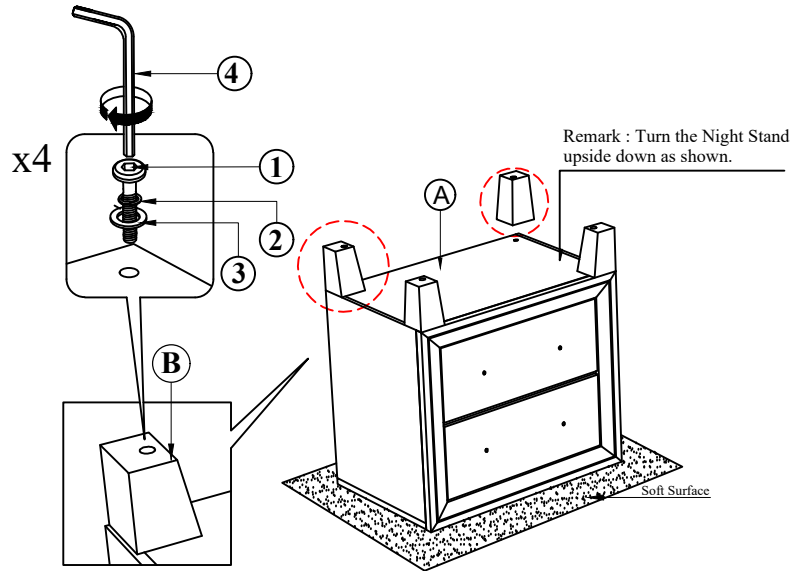

STEP 3 : Install the handle by unscrewing the bolts with a screwdriver and move the handle to the outside of the drawers and screw the bolts back in from the inside of the drawers. Repeat for each handle.

