



bestchoiceproducts



INSTRUCTION MANUAL

LED Mirrored Jewelry Armoire
with Drawer

! NOTICE

Please retain these instructions for future reference.

- Please do not exceed the weight limitations of this item.
- Firmly secure all bolts, screws and knobs before use.
- Reconfirm that all bolts, screws, and knobs are secure every 90 days.
- Fasten screws loosely during initial assembly. Do not fully tighten screws until the item is completely assembled.
- Do not use or store this item in the proximity of open flame or flammable/combustible chemicals.
- Be aware that some parts are heavy and have sharp edges.
- If any parts are missing, broken, damaged, or worn, stop using this product until repairs are made and/or factory replacement parts are installed.
- Do not use this item in a way inconsistent with the manufacturer's instructions as this could void the product warranty.

TOOLS REQUIRED



PHILLIPS
SCREWDRIVER



12 AA BATTERIES



15 LBS
CAPACITY



1 PERSON
ASSEMBLY



APPROXIMATELY
30 MIN.
ASSEMBLY

HARDWARE

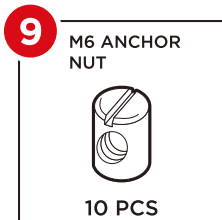
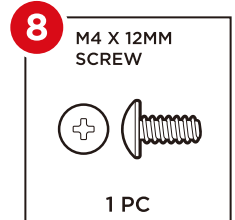
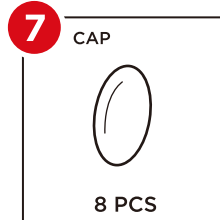
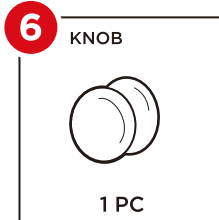
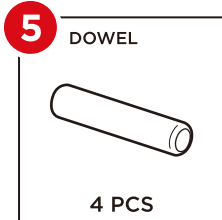
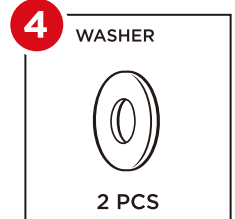
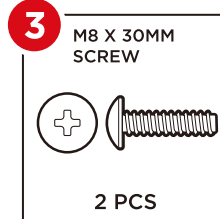
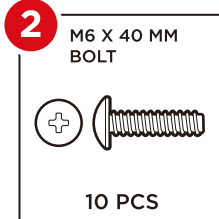
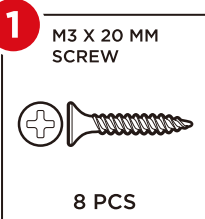

PARTS

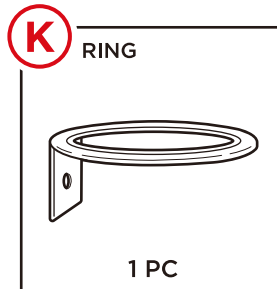
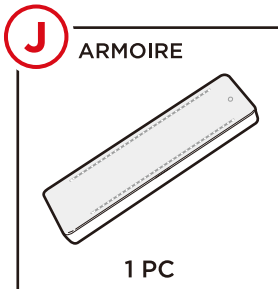
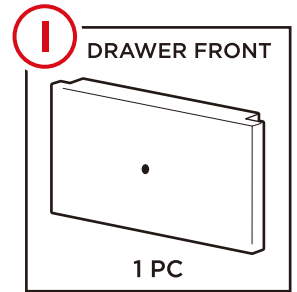
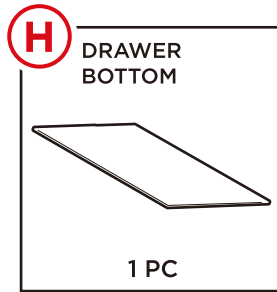
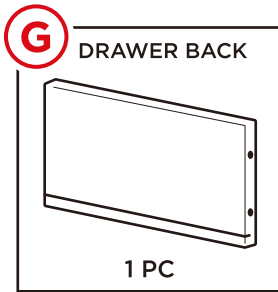
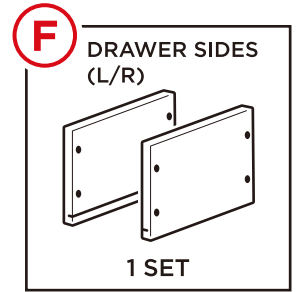
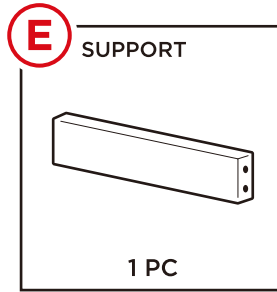
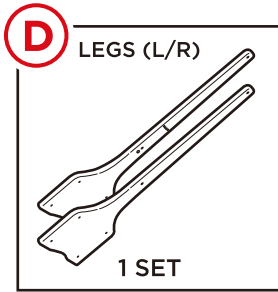
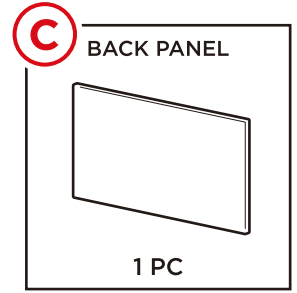
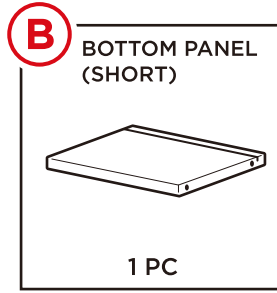
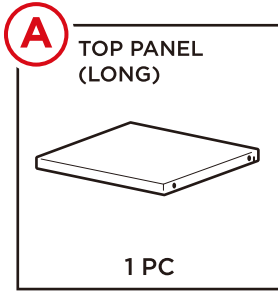

PRODUCT ASSEMBLY

1

Insert ten part 9 anchor nuts into the part A top panel, part B bottom panel, and part E support. Insert part C back panel between the top panel and bottom panel. Attach the top/bottom panels to the part D legs with eight part 2 bolts. Place eight part 7 caps on the bolts.

NOTE: The top panel is longer than the bottom panel.

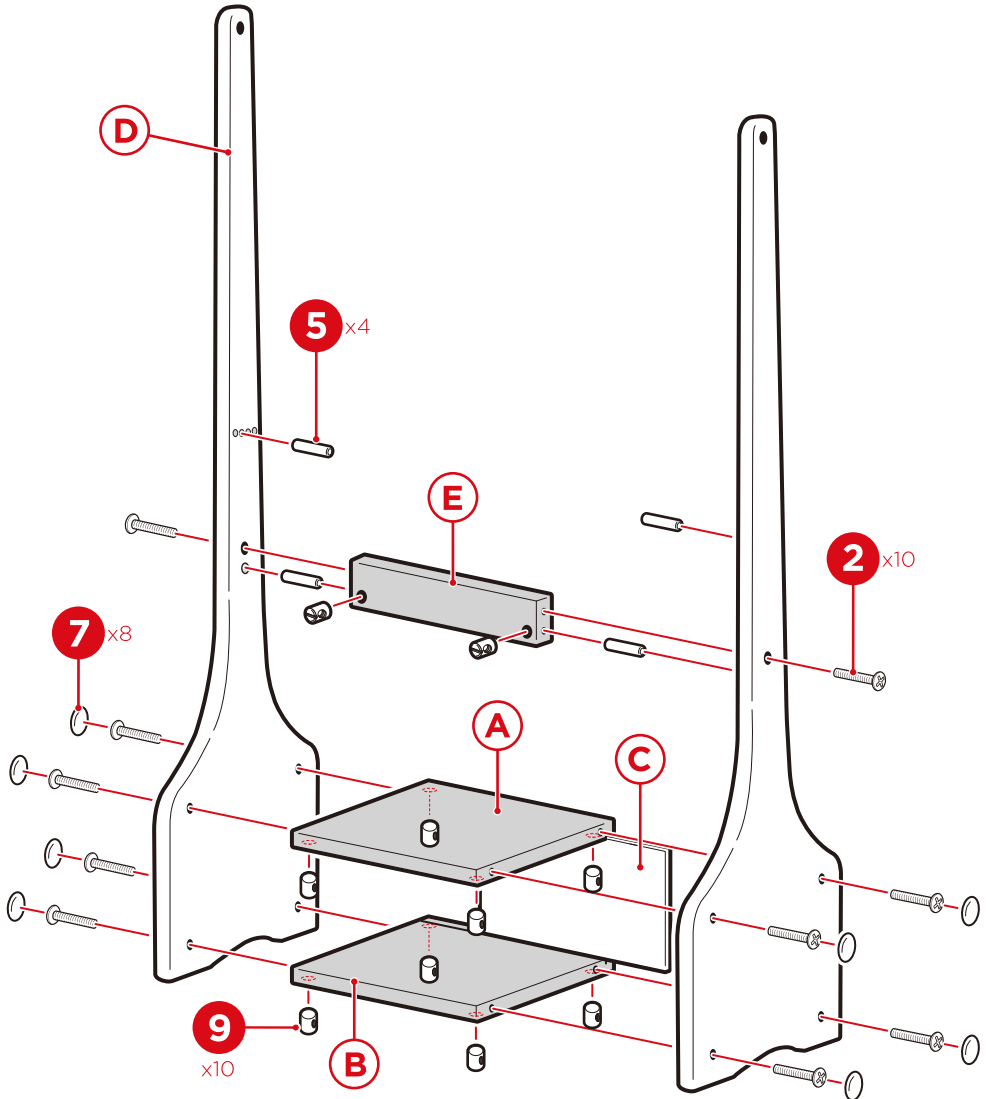

Attach part E support with two part 2 bolts and two part 5 dowels, a bolt and dowel per side. Insert two dowels into the legs, one on each side.

NOTE: Different holes change the angle of the mirror. Move dowels to adjust angle.

PRODUCT ASSEMBLY

2

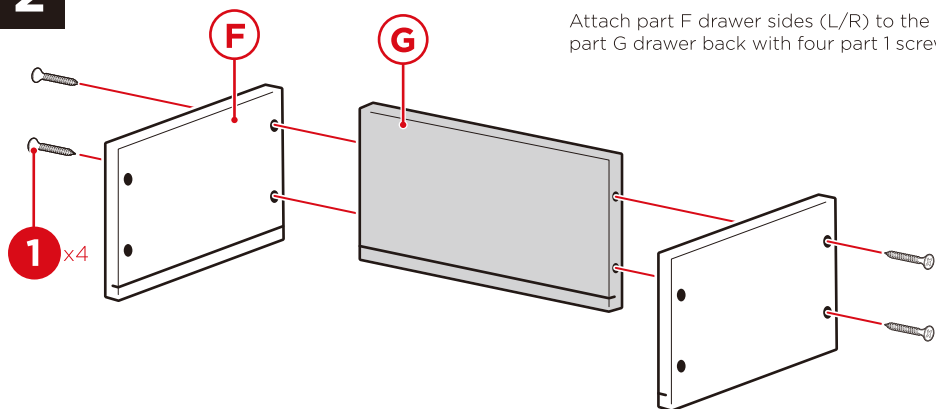

Attach part F drawer sides (L/R) to the part G drawer back with four part 1 screws.

3

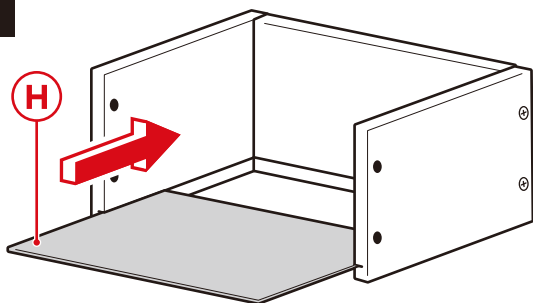

Slide in the part H drawer bottom.

4

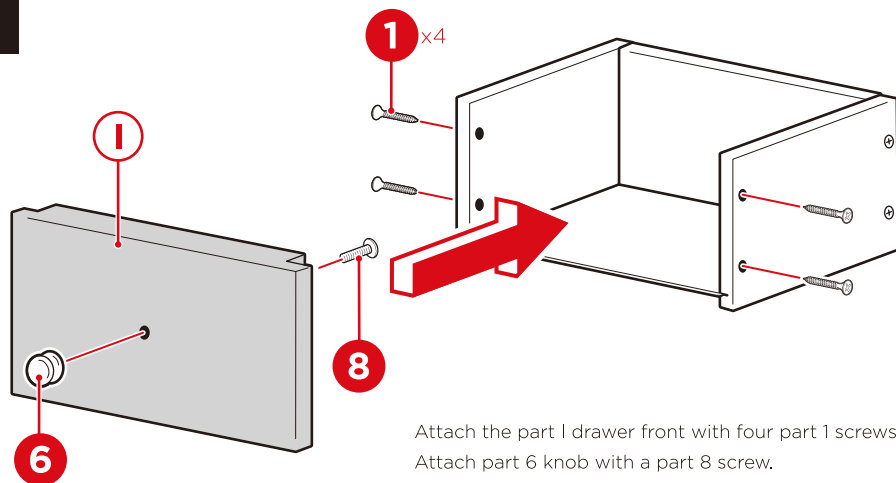

Attach the part I drawer front with four part 1 screws.
Attach part 6 knob with a part 8 screw.

PRODUCT ASSEMBLY

5

Attach part J armoire and part K ring to the legs with two part 3 screws and two part 4 washers, a screw and washer per side.

Slide in the drawer.

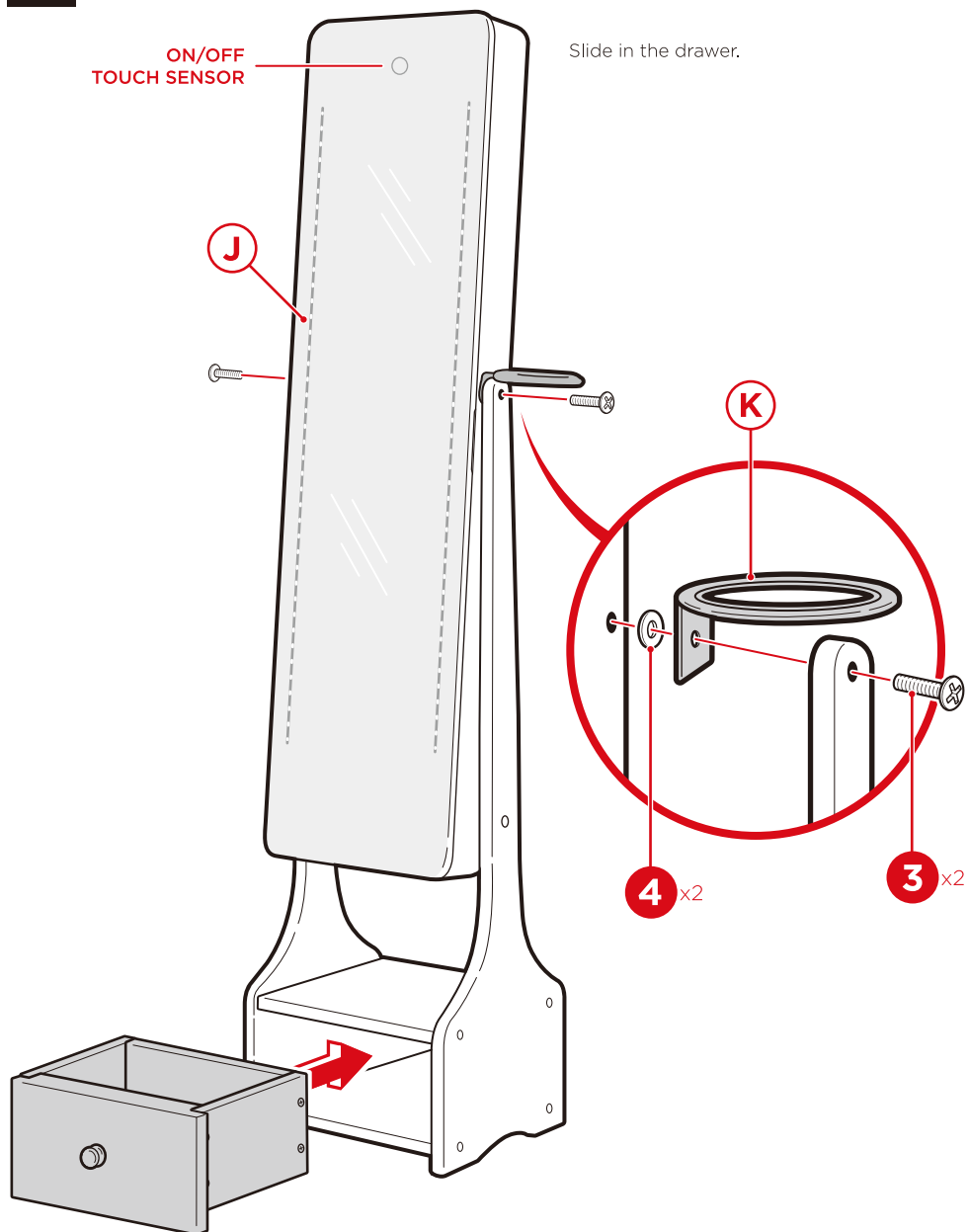

INSTALLING BATTERIES

This armoire requires a total of 12 AA batteries, 6 for the LEDs on the mirror and 6 for the internal LEDs.

- Install 6 AA batteries in the compartment behind the mirror. Flip the power switch, then use the touch sensor on the front to turn the LEDs on the mirror on/off.
- Fold open the table, remove the cover, and install 6 batteries in the compartment below the inside mirror. Flip the power switch, then fold/unfold the table to turn the inside LEDs on/off.

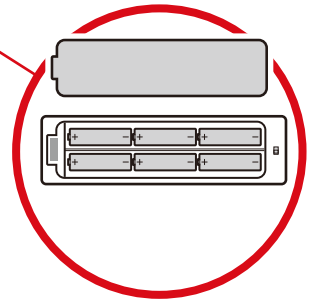
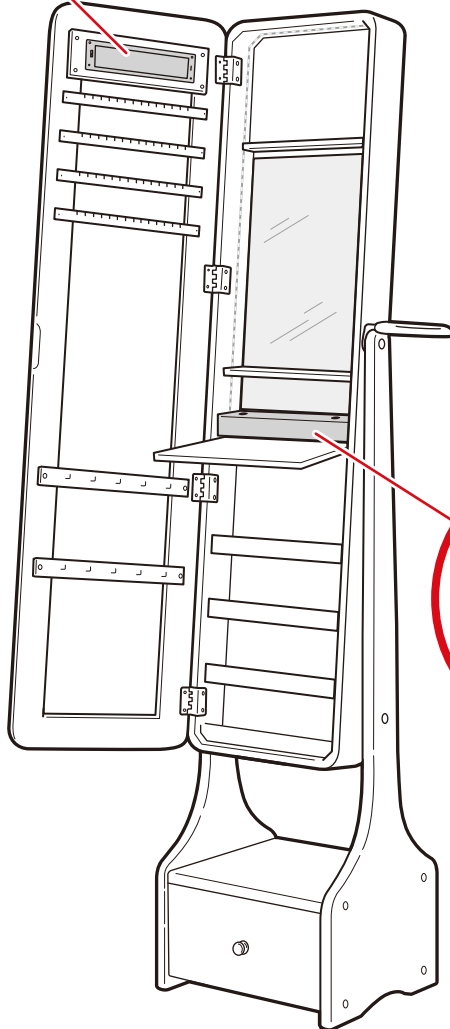
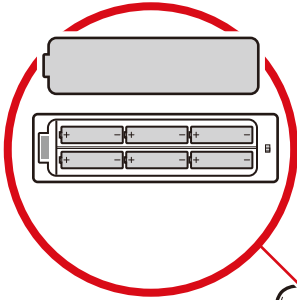

ENJOY YOUR PRODUCT!

bcp

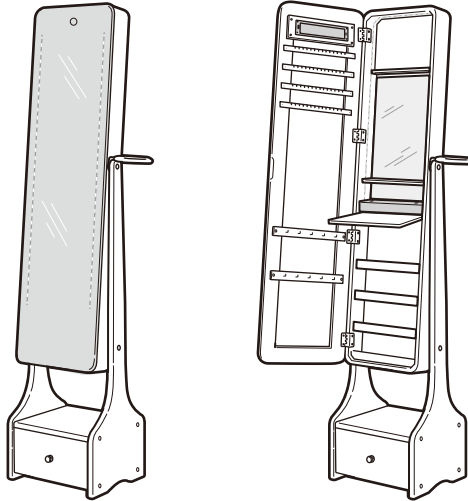

PRODUCT WARRANTY INFORMATION

All items can be returned for any reason within 60 days of the receipt and will receive a full refund as long as the item is returned in its original product packaging and all accessories from its original shipment are included. All returned items will receive a full refund back to the original payment method. All returned items will not be charged a re-stocking fee.

All returned items require an RA (Return Authorization) number, which can only be provided by a Best Choice Products Customer Service Representative when the return request is submitted. Items received without an RA may not be accepted or may increase your return processing time. Once an item has been received by Best Choice Products, refunds or replacements will be processed within 5 business days.

All returns must be shipped back to the Best Choice Products Return Center at the customer's expense. If the reason for return is a result of an error by Best Choice Products then Best Choice Products will provide a pre-paid shipping label via email. Boxes for return shipping will not be provided by Best Choice Products, and is the customer's responsibility to either use the original shipping boxes or purchase new boxes.

Pictures may be required for some returns to ensure an item is not damaged prior to its return. Items returned are not considered undamaged until they are received by Best Choice Products and verified as such. All damages to items are the customer's responsibility until the item has been received by and acknowledge by Best Choice Products as undamaged.

CONTACT US; WE'RE HERE 7 DAYS A WEEK TO HELP YOU!



bestchoiceproducts.com



customerservice@bestchoiceproducts.com



844.948.8400



LEARN MORE!

WARNING

Manufacturer and seller expressly disclaim any and all liability for personal injury, property damage or loss, whether direct, indirect, or incidental, resulting from the incorrect attachment, improper use, inadequate maintenance, or neglect of this product.