







HEKMAN®

X A HOWARD MILLER COMPANY

24605 ROUND END TABLE

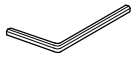
HARDWARE LIST				
A	B	C	D	E
ALLEN BOLT M6 x 70 (8 Pcs)	FLAT W. M6 (8 Pcs)	LOCK W. M8 (10 Pcs)	SCREW Ø6 x 3/8" (4 Pcs)	ALLEN KEY L4 (FOR BOLT M6) 1 Pc
				

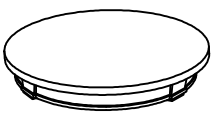

PART INSIDE		
1	2	3
TOP ASSEMBLY (1 Pc)	LEGS (4 Pcs)	SHELF (1 Pc)
		

Assembly Instruction

STEP 1.

LAY TOP ASSEMBLY UPSIDE DOWN ON A SOFT, CLEAN AND FLAT SURFACE. ALIGN BOLTS IN APRON BLOCKS WITH HOLE IN LEGS. CONNECT USING FLAT WASHER (B), LOCK WASHER (C), ALLEN BOLT (A) AND ALLEN KEY (E) PROVIDED.

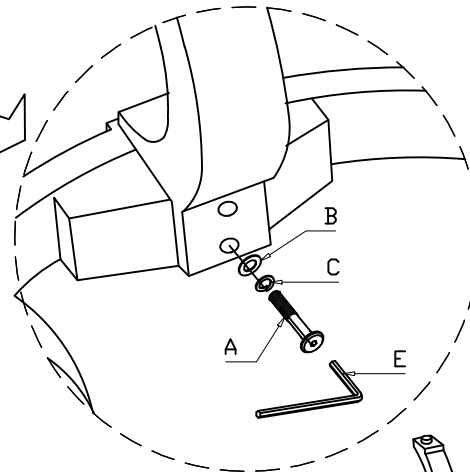
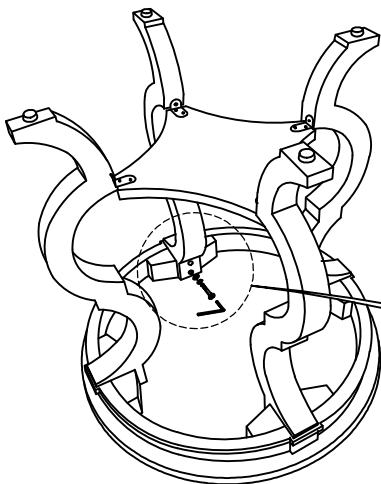

STEP 2

ALIGN AND FASTEN SHELF TO LEGS USING SCREW (D) AND TIGHTEN WITH SCREW DRIVER (NOT INCLUDED).

