

EXTERIOR LIGHTING

BY  EUROfase®

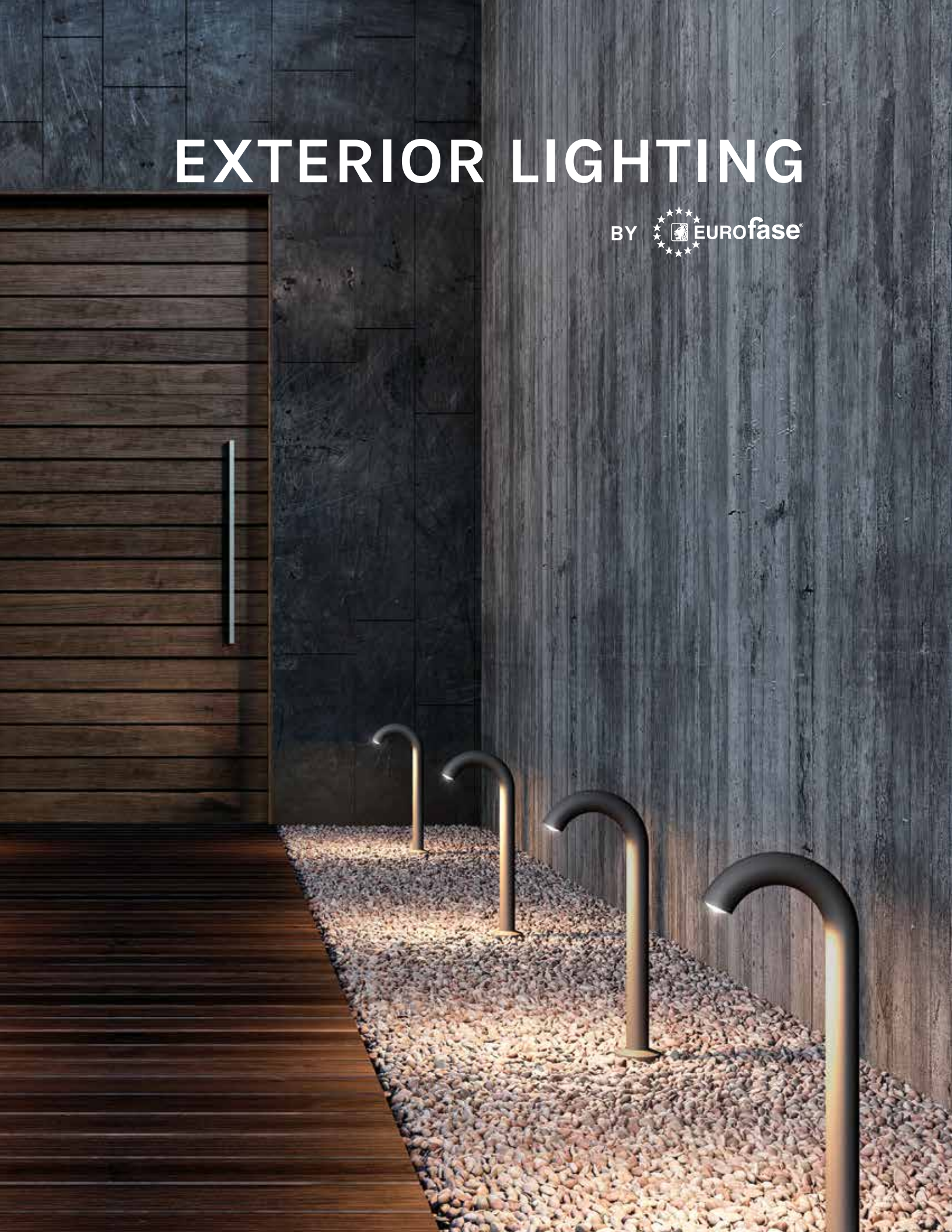

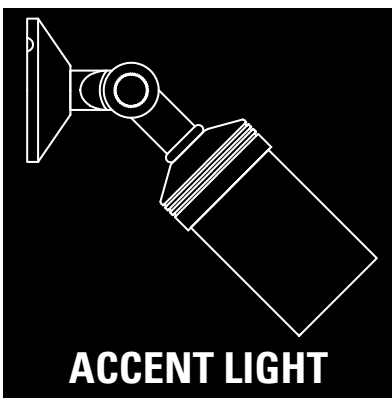

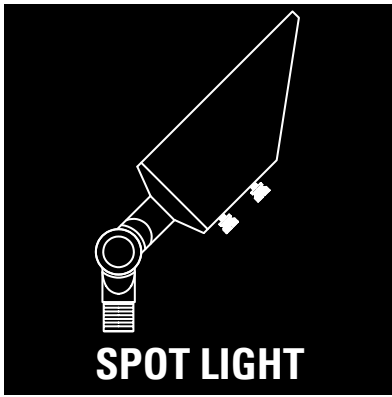
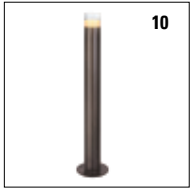
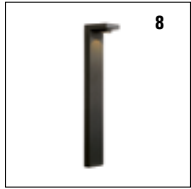
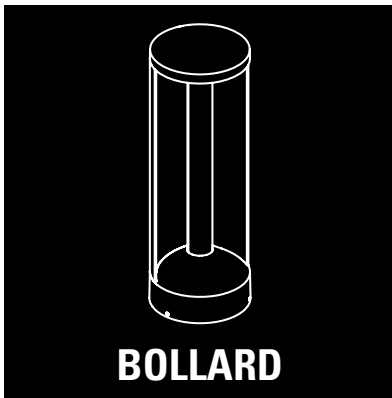
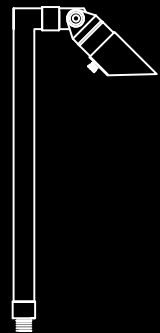

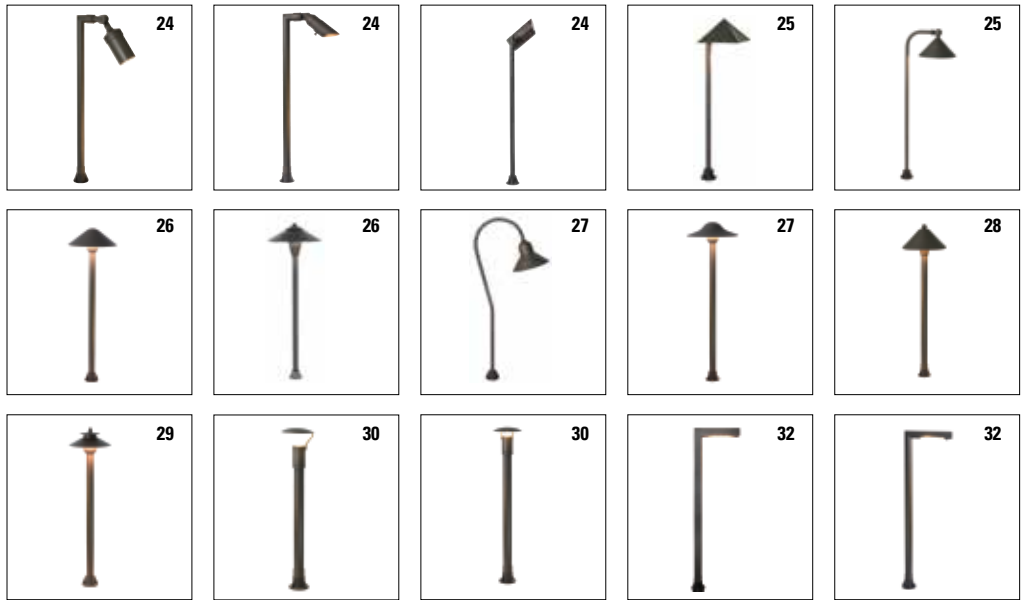
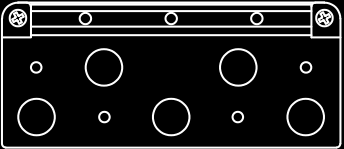

PATH LIGHT



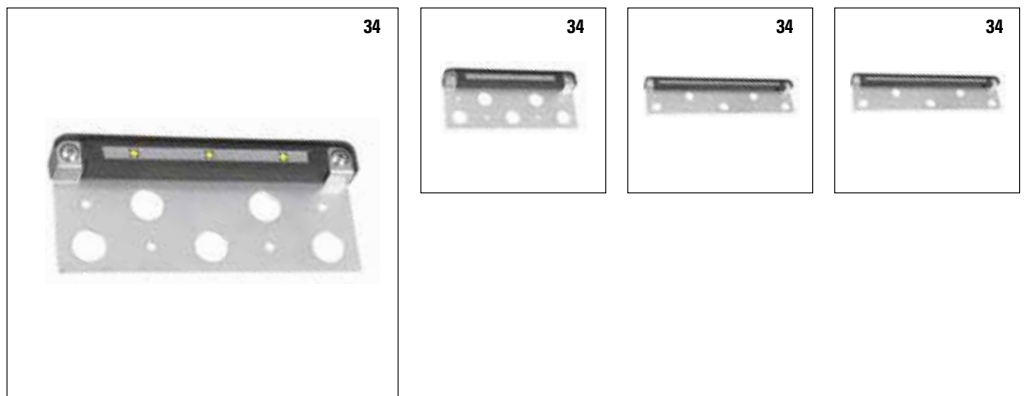

HARDSCAPE

ACCESSORIES



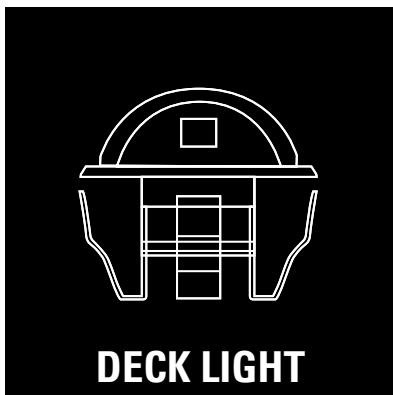
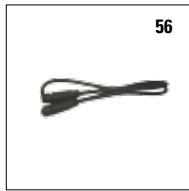
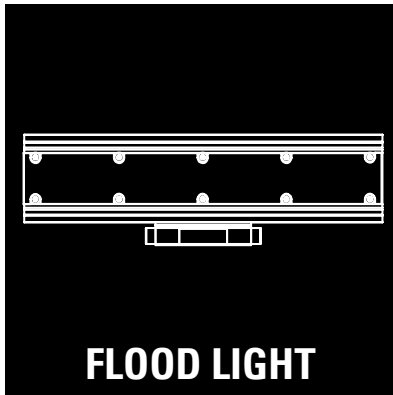



SURFACE MOUNT

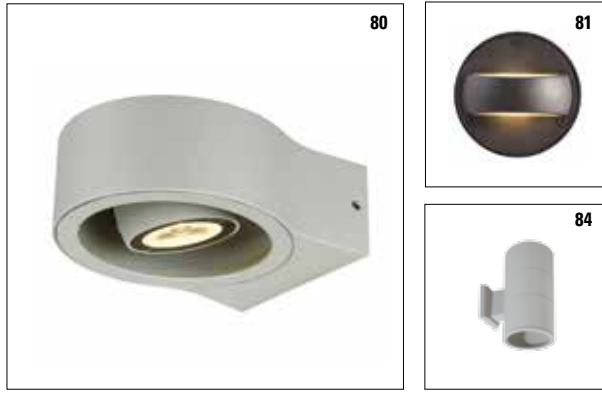
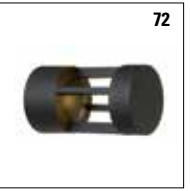
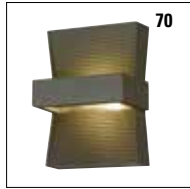
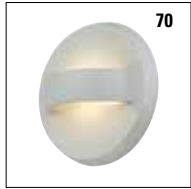
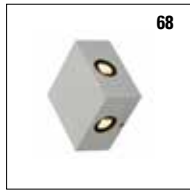
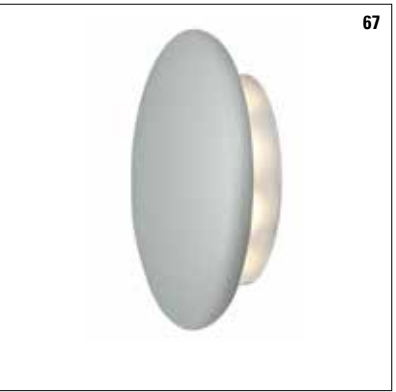
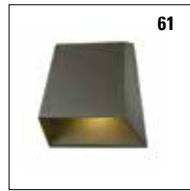
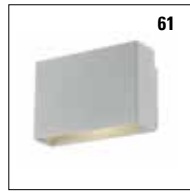

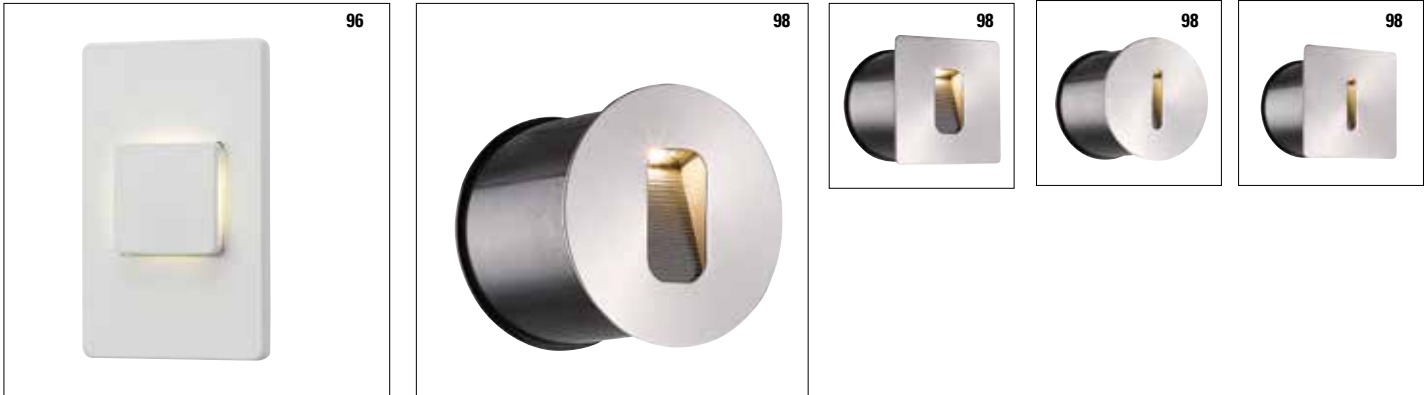
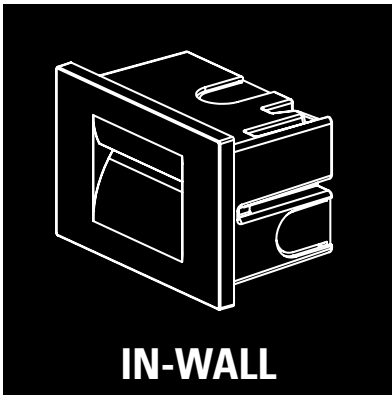

BOLLARD

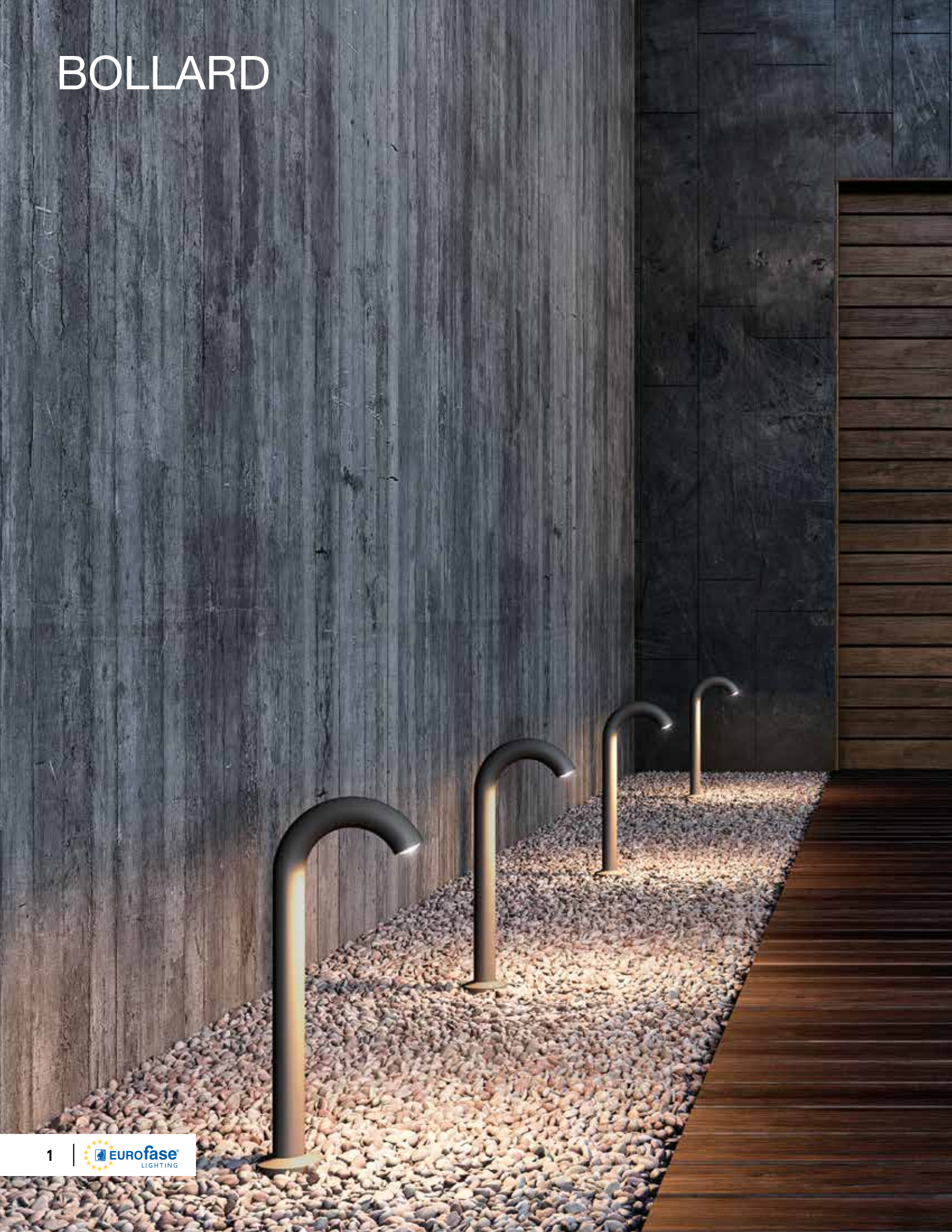

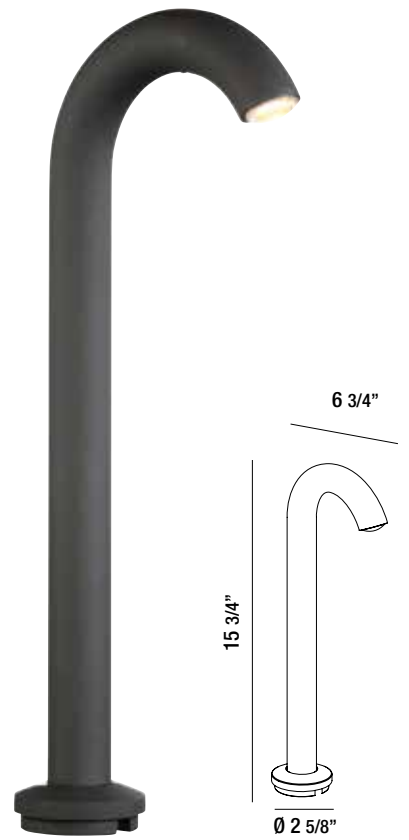

31912-020

- 1 x 4W CREE LED
- 3000 Kelvin
- Lumen Output: 320lm
- LED driver included
- IP 65
- CRI: 80+
- High corrosion resistant die-cast aluminum body
- Stainless steel screws
- Electronic driver 120V 50/60Hz
- Silicone rubber gasket
- Powder coated graphite grey finish



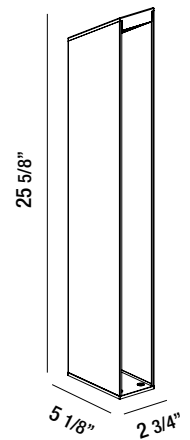

31915-021

- 3 x 3W CREE LED
- 3000 Kelvin
- Lumen Output: 100lm
- LED driver included
- Electronic driver 120V 50/60Hz
- IP 54
- CRI: 80+
- High corrosion resistant die-cast aluminum body
- Stainless steel screws
- Silicone rubber gasket
- Powder coated graphite grey finish



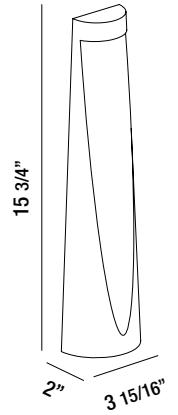

31916-028

- 1 x 7W CREE LED
- 3000 Kelvin
- Lumen Output: 300lm
- LED driver included
- Electronic driver 120V 50/60Hz
- IP 65
- CRI: 80+
- High corrosion resistant die-cast aluminum body
- Stainless steel screws
- Silicone rubber gasket
- Powder coated graphite grey finish





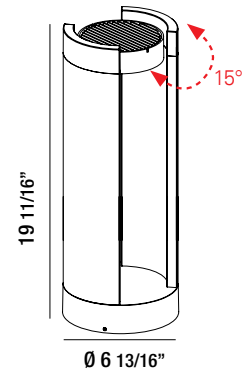

31922-029

- 15W LED
- 3000 Kelvin
- Lumen Output: 720lm
- Line voltage AC LED included 120V input
- IP 65
- High corrosion resistant die-cast aluminum body
- Stainless steel screws
- Silicone rubber gasket
- Powder coated graphite grey finish

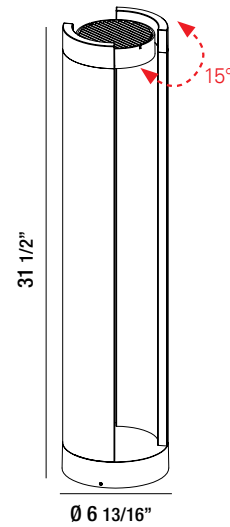

31923-026

- 15W LED
- 3000 Kelvin
- Lumen Output: 720lm
- Line voltage AC LED included 120V input
- IP 65
- High corrosion resistant die-cast aluminum body
- Stainless steel screws
- Silicone rubber gasket
- Powder coated graphite grey finish



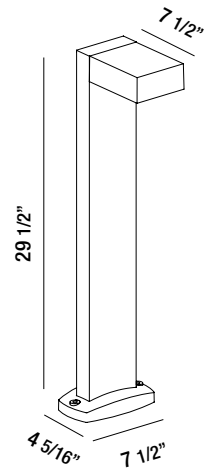

31909-027

- 1 x 7W CREE LED
- 3000 Kelvin
- Lumen Output: 340lm
- LED driver included
- Electronic driver 120V 50/60Hz
- IP 54
- CRI: 80+
- High corrosion resistant aluminum body
- Stainless steel screws
- Silicone rubber gasket
- Powder coated graphite grey finish



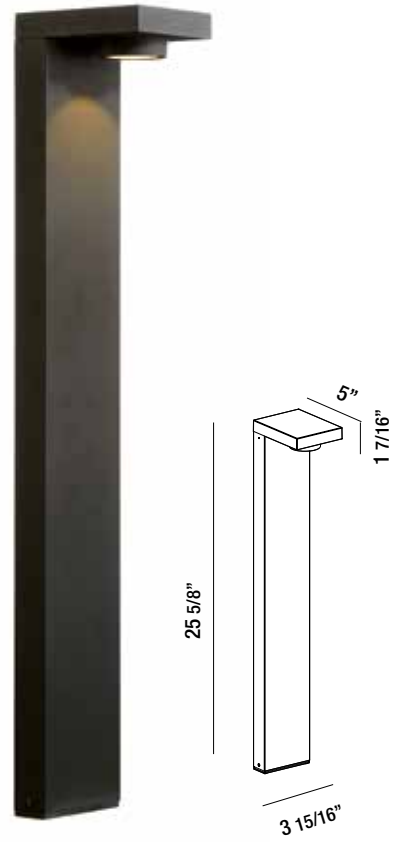

31911-023

- 1 x 7W CREE LED
- 3000 Kelvin
- Lumen Output: 280lm
- LED driver included
- Electronic driver 120V 50/60Hz
- IP 54
- CRI: 80+
- High corrosion resistant die-cast aluminum body
- Stainless steel screws
- Silicone rubber gasket
- Powder coated graphite grey finish



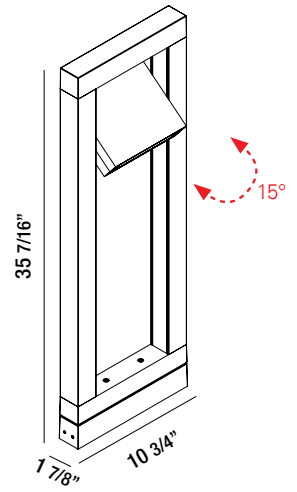

31918-022

- 16W CREE LED
- 3000 Kelvin
- Lumen Output: 900lm
- LED driver included
- Electronic driver 120V 50/60Hz
- IP 65
- CRI: 80+
- High corrosion resistant die-cast aluminum body
- Stainless steel screws
- Silicone rubber gasket
- Powder coated graphite grey finish



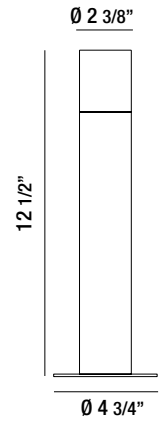

31947-015

- 3 x 2W CREE LED
- 2700 Kelvin
- Lumen Output: 250lm
- Transformer not included
- IP 65
- CRI: 80+
- Solid brass body
- Antique bronze finish
- 3 feet of waterproof, copper core, PVC jacketed body, UV protected wire included

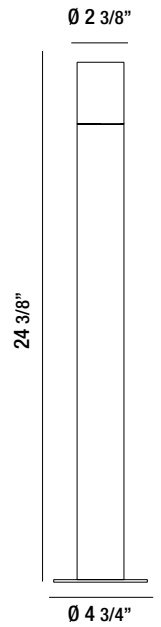

31948-012

- 3 x 2W CREE LED
- 2700 Kelvin
- Lumen Output: 250lm
- Transformer not included
- IP 65
- CRI: 80+
- Solid brass body
- Antique bronze finish
- 3 feet of waterproof, copper core, PVC jacketed body, UV protected wire included



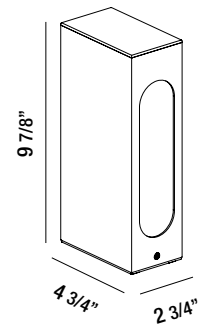

31913-027

- 1 x 7W CREE LED
- 3000 Kelvin
- Lumen Output: 140lm
- LED driver included
- Electronic driver 120V 50/60Hz
- IP 54
- CRI: 80+
- High corrosion resistant die-cast aluminum body
- Stainless steel screws
- Silicone rubber gasket
- Powder coated graphite grey finish



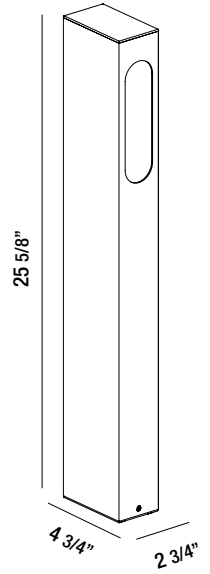

31914-024

- 1 x 7W CREE LED
- 3000 Kelvin
- Lumen Output: 140lm
- LED driver included
- Electronic driver 120V 50/60Hz
- IP 54
- CRI: 80+
- High corrosion resistant die-cast aluminum body
- Stainless steel screws
- Silicone rubber gasket
- Powder coated graphite grey finish





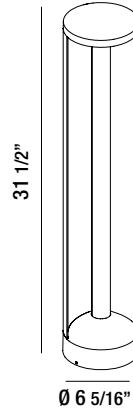
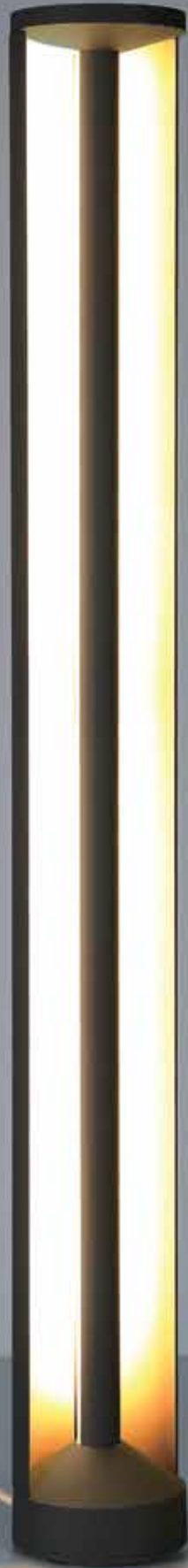

31921-022

- 15W LED
- 3000 Kelvin
- Lumen Output: 780lm
- Line voltage AC LED included 120V input
- IP 65
- High corrosion resistant die-cast aluminum body
- Stainless steel screws
- Silicone rubber gasket
- Powder coated graphite grey finish

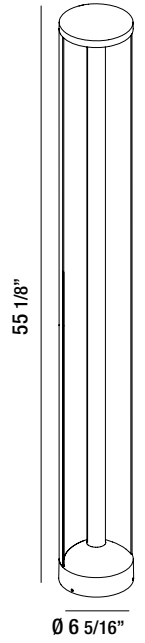

31919-029

- 30W LED
- 3000 Kelvin
- Lumen Output: 1340lm
- Line voltage AC LED included 120V input
- IP 65
- High corrosion resistant die-cast aluminum body
- Stainless steel screws
- Silicone rubber gasket
- Powder coated graphite grey finish

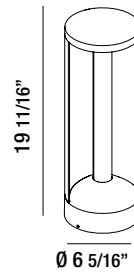

31920-025

- 12W LED
- 3000 Kelvin
- Lumen Output: 500lm
- Line voltage AC LED included 120V input
- IP 65
- High corrosion resistant die-cast aluminum body
- Stainless steel screws
- Silicone rubber gasket
- Powder coated graphite grey finish



LANDSCAPE

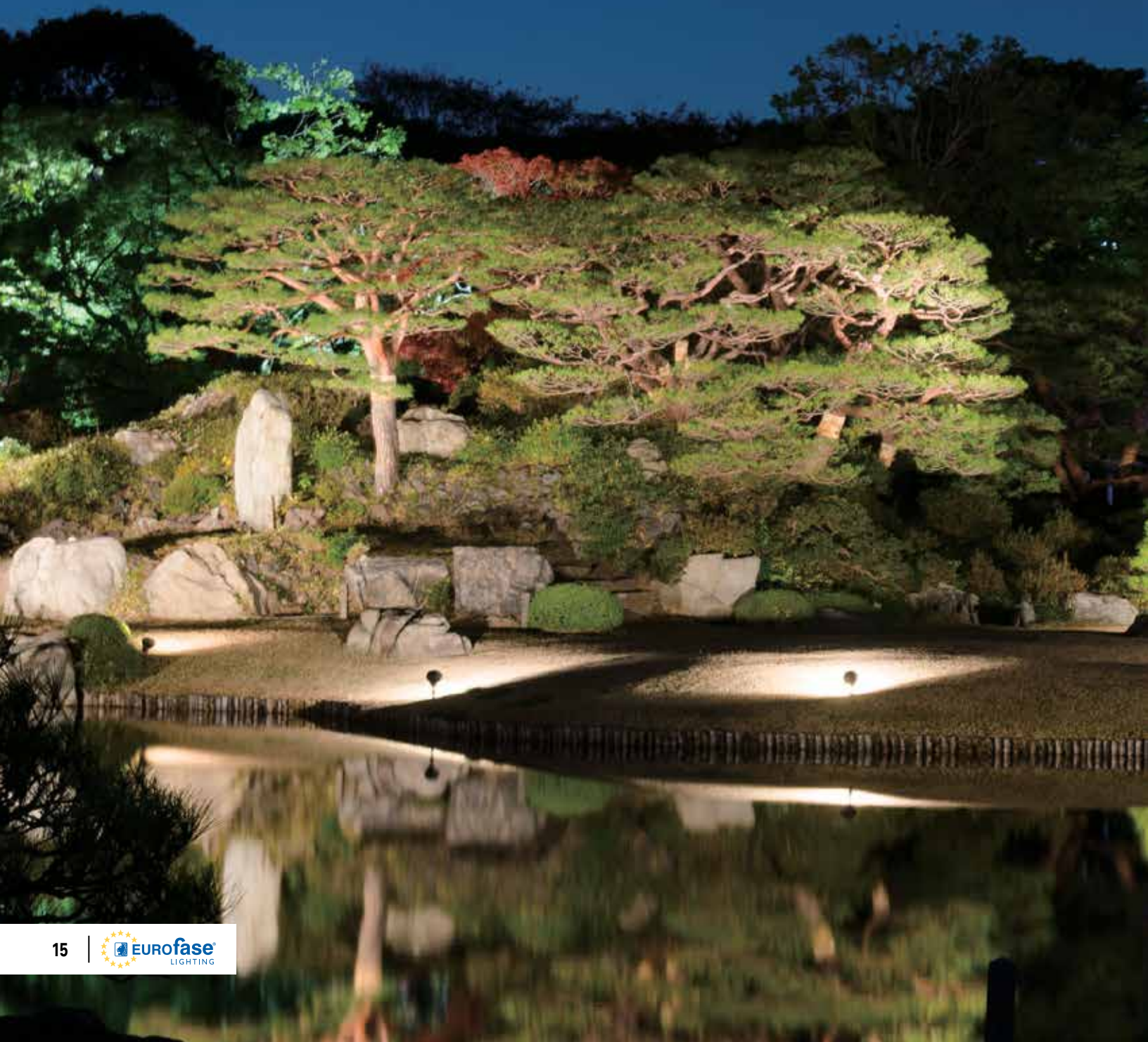



SPOT LIGHT

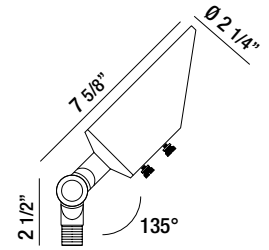

31949-019

- 3 x 2W LED
- 2700 Kelvin
- Lumen Output: 300lm
- Transformer not included
- IP 65
- CRI: 80+
- Solid brass body
- Antique bronze finish
- 3 feet of waterproof, copper core, PVC jacketed body, UV protected wire included
- 8" Stake included. For more mounting options, refer to page #35.
- Available in narrow and wide beam angle. Refer to page #36



SPOT 40°

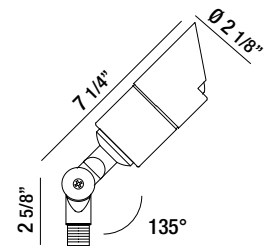

31950-015

- 3 x 2W LED
- 2700 Kelvin
- Lumen Output: 300lm
- Transformer not included
- IP 65
- CRI: 80+
- Solid brass body
- Antique bronze finish
- 3 feet of waterproof, copper core, PVC jacketed body, UV protected wire included
- 8" Stake included. For more mounting options, refer to page #35.
- Available in narrow and wide beam angle. Refer to page #36



SPOT 40°

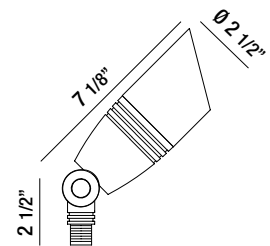

31973-014

- 3 x 2W LED
- 2700 Kelvin
- Lumen Output: 300lm
- Transformer not included
- IP 65
- CRI: 80+
- Solid brass body
- Antique bronze finish
- 3 feet of waterproof, copper core, PVC jacketed body, UV protected wire included
- 8" Stake included. For more mounting options, refer to page #35.
- Available in narrow and wide beam angle. Refer to page #36



SPOT 40°





31951-012

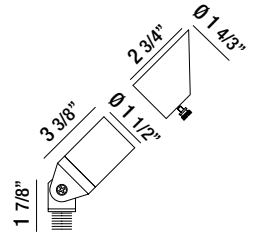

- 1 x 3W LED
- 2700 Kelvin
- Lumen Output: 120lm
- Transformer not included
- IP 65
- CRI: 80+
- Solid brass body
- Antique bronze finish
- 3 feet of waterproof, copper core, PVC jacketed body, UV protected wire included
- 8" Stake included. For more mounting options, refer to page #35.



SPOT 40°



31952-019

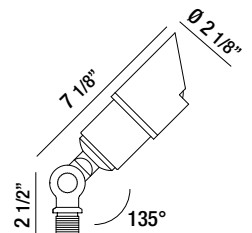

- 3 x 2W LED
- 2700 Kelvin
- Lumen Output: 300lm
- Transformer not included
- IP 65
- CRI: 80+
- Solid brass body
- Antique bronze finish
- 3 feet of waterproof, copper core, PVC jacketed body, UV protected wire included
- 8" Stake included. For more mounting options, refer to page #35.
- Available in narrow and wide beam angle. Refer to page #36



SPOT 40°



31926-010

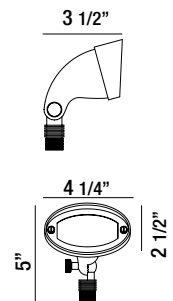

- 1 x 3W LED
- 2700 Kelvin
- Lumen Output: 120lm
- Transformer not included
- IP 65
- CRI: 80+
- Solid brass body
- Antique bronze finish
- 3 feet of waterproof, copper core, PVC jacketed body, UV protected wire included
- 8" Stake included. For more mounting options, refer to page #35.



SPOT 40°



ACCENT LIGHT

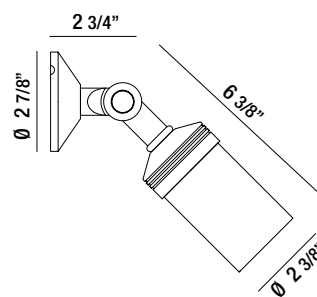

31974-011

- 3 x 2W LED
- 2700 Kelvin
- Lumen Output: 300lm
- Transformer not included
- IP 65
- CRI: 80+
- Solid brass body
- Antique bronze finish
- 3 feet of waterproof, copper core, PVC jacketed body, UV protected wire included
- Available in narrow and wide beam angle. Refer to page #36



SPOT 40°



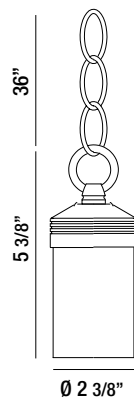

31930-017

- 3 x 2W LED
- 2700 Kelvin
- Lumen Output: 300lm
- Transformer not included
- IP 65
- CRI: 80+
- Solid brass body
- Antique bronze finish
- 3 feet of waterproof, copper core, PVC jacketed body, UV protected wire included
- Available in narrow and wide beam angle. Refer to page #36



UNDERWATER



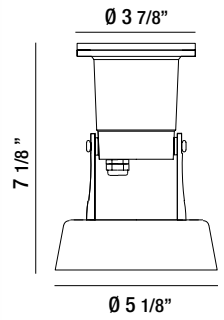

31959-018

- 3 x 2W LED
- 2700 Kelvin
- Lumen Output: 300lm
- Transformer not included
- Solid brass body
- IP 68
- CRI: 80+
- Antique bronze finish
- 25 feet of waterproof, copper core, PVC jacketed body, UV protected wire included
- Tempered safety glass
- Available in narrow and wide beam angle. Refer to page #36



SPOT 40°

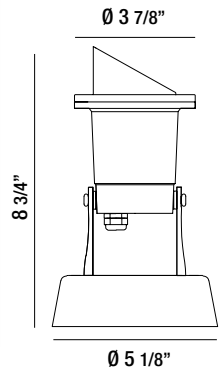

31960-014

- 3 x 2W LED
- 2700 Kelvin
- Lumen Output: 300lm
- Transformer not included
- Solid brass body
- IP 68
- CRI: 80+
- Antique bronze finish
- 25 feet of waterproof, copper core, PVC jacketed body, UV protected wire included
- Tempered safety glass
- Available in narrow and wide beam angle. Refer to page #36.



SPOT 40°



— UNDERWATER



PATH LIGHT





31942-010

- 3 x 2W LED
- 2700 Kelvin
- Lumen Output: 300lm
- Transformer not included
- IP 65
- CRI: 80+
- Solid brass body
- Antique bronze finish
- 3 feet of waterproof, copper core, PVC jacketed body, UV protected wire included
- 8" Stake included. For more mounting options, refer to page #35.
- Available in narrow and wide beam angle. Refer to page #36

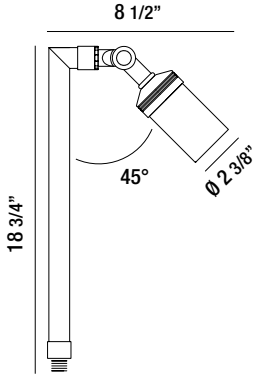

SPOT 40°



31941-013

- 3W LED
- 2700 Kelvin
- Lumen Output: 120lm
- Transformer not included
- IP 65
- CRI: 80+
- Solid brass body
- Antique bronze finish
- 3 feet of waterproof, copper core, PVC jacketed body, UV protected wire included
- 8" Stake included. For more mounting options, refer to page #35.

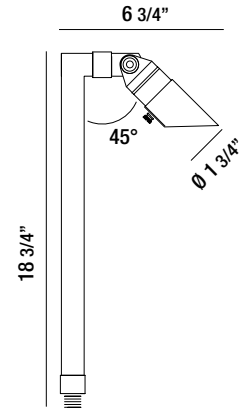

SPOT 40°



31975-018

- 3 x 2W LED
- 2700 Kelvin
- Lumen Output: 300lm
- Transformer not included
- IP 65
- CRI: 80+
- Solid brass body
- Antique bronze finish
- 3 feet of waterproof, copper core, PVC jacketed body, UV protected wire included
- 8" Stake included. For more mounting options, refer to page #35.
- Available in narrow and wide beam angle. Refer to page #36

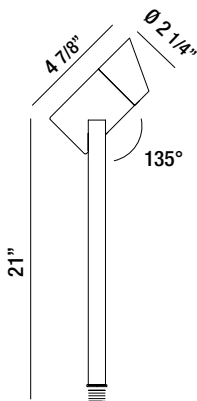

SPOT 40°



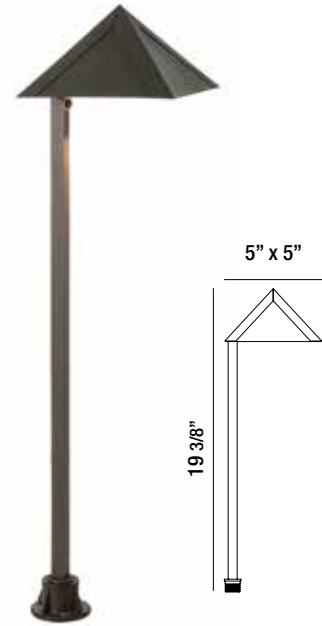

31933-018

- 4W LED
- 2700 Kelvin
- Lumen Output: 150lm
- Transformer not included
- IP 65
- CRI: 80+
- Solid brass body
- Antique bronze finish
- 3 feet of waterproof, copper core, PVC jacketed body, UV protected wire included
- 8" Stake included. For more mounting options, refer to page #35.

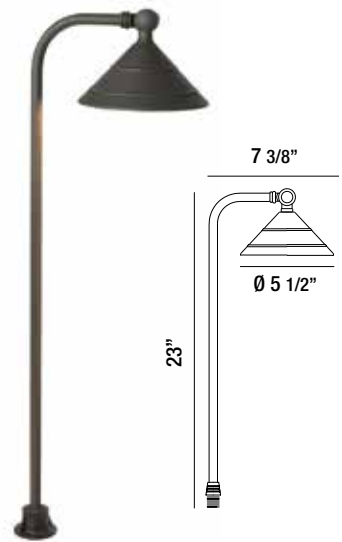

31932-011

- 4W LED
- 2700 Kelvin
- Lumen Output: 150lm
- Transformer not included
- IP 65
- CRI: 80+
- Solid brass body
- Antique bronze finish
- 3 feet of waterproof, copper core, PVC jacketed body, UV protected wire included
- 8" Stake included. For more mounting options, refer to page #35.



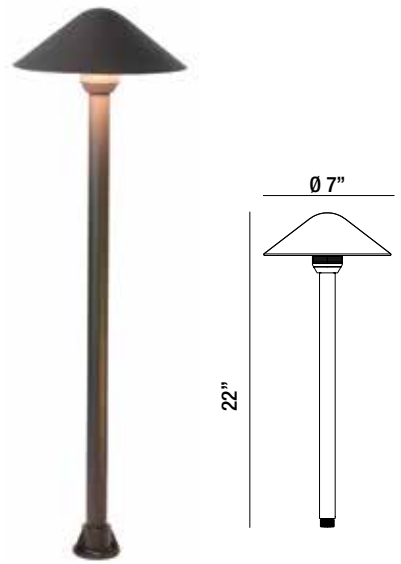

31934-015

- 4W LED
- 2700 Kelvin
- Lumen Output: 150lm
- Transformer not included
- IP 65
- CRI: 80+
- Solid brass body
- Antique bronze finish
- 3 feet of waterproof, copper core, PVC jacketed body, UV protected wire included
- 8" Stake included. For more mounting options, refer to page #35.

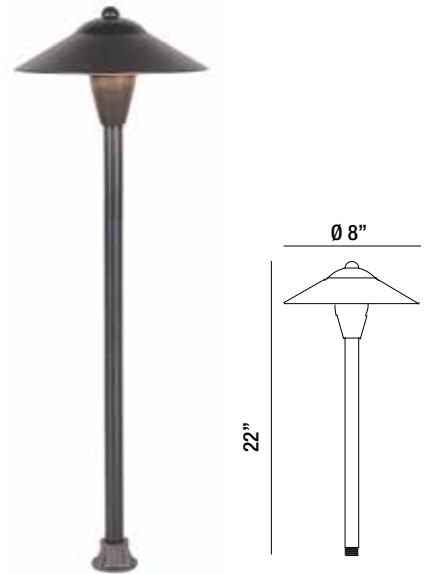

31935-012

- 4W LED
- 2700 Kelvin
- Lumen Output: 150lm
- Transformer not included
- IP 65
- CRI: 80+
- Solid Aluminum body
- Antique bronze finish
- 3 feet of waterproof, copper core, PVC jacketed body, UV protected wire included
- 8" Stake included. For more mounting options, refer to page #35.





31931-014

- 4W LED
- 2700 Kelvin
- Lumen Output: 150lm
- Transformer not included
- IP 65
- CRI: 80+
- Solid brass body
- Antique bronze finish
- 3 feet of waterproof, copper core, PVC jacketed body, UV protected wire included
- 8" Stake included. For more mounting options, refer to page #35.

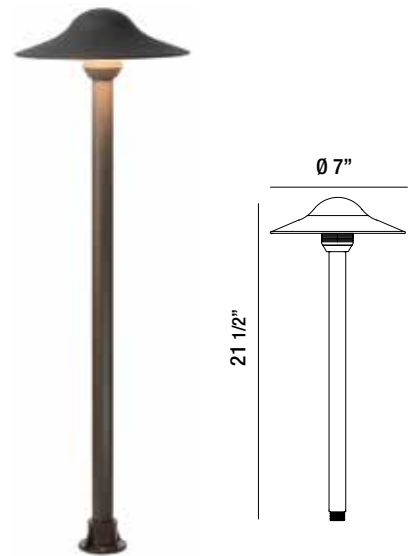

31936-019

- 4W LED
- 2700 Kelvin
- Lumen Output: 150lm
- Transformer not included
- IP 65
- CRI: 80+
- Solid brass body
- Antique bronze finish
- 3 feet of waterproof, copper core, PVC jacketed body, UV protected wire included
- 8" Stake included. For more mounting options, refer to page #35.



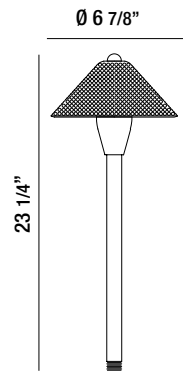

31937-016

- 4W LED
- 2700 Kelvin
- Lumen Output: 150lm
- Transformer not included
- IP 65
- CRI: 80+
- Solid brass body
- Antique bronze finish
- 3 feet of waterproof, copper core, PVC jacketed body, UV protected wire included
- 8" Stake included. For more mounting options, refer to page #35.

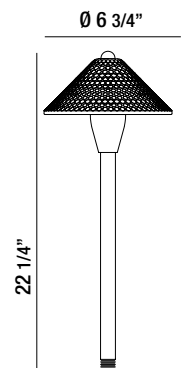

31938-013

- 4W LED
- 2700 Kelvin
- Lumen Output: 200lm
- Transformer not included
- IP 65
- CRI: 80+
- Solid aluminum body
- Antique bronze finish
- 3 feet of waterproof, copper core, PVC jacketed body, UV protected wire included
- 8" Stake included. For more mounting options, refer to page #35.



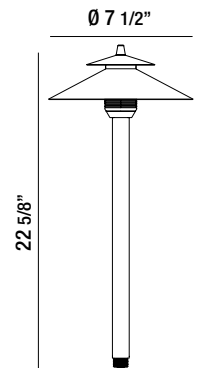

31939-010

- 4W LED
- 2700 Kelvin
- Lumen Output: 150lm
- Transformer not included
- IP 65
- CRI: 80+
- Solid brass body
- Antique bronze finish
- 3 feet of waterproof, copper core, PVC jacketed body, UV protected wire included
- 8" Stake included. For more mounting options, refer to page #35.

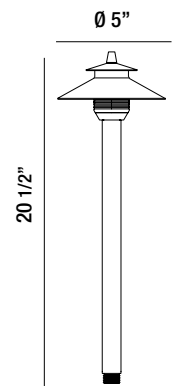

31940-016

- 4W LED
- 2700 Kelvin
- Lumen Output: 150lm
- Transformer not included
- IP 65
- CRI: 80+
- Solid brass body
- Antique bronze finish
- 3 feet of waterproof, copper core, PVC jacketed body, UV protected wire included
- 8" Stake included. For more mounting options, refer to page #35.



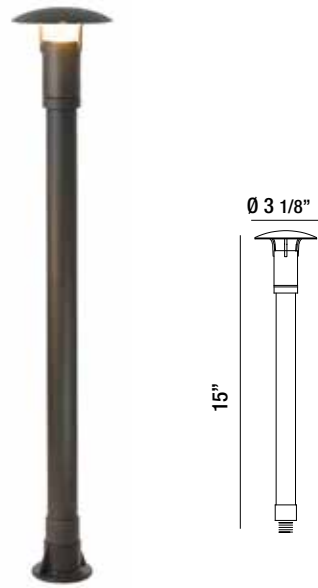

31943-017

- 3W LED
- 2700 Kelvin
- Lumen Output: 120lm
- Transformer not included
- IP 65
- CRI: 80+
- Solid brass body
- Antique bronze finish
- 3 feet of waterproof, copper core, PVC jacketed body, UV protected wire included
- 8" Stake included. For more mounting options, refer to page #35.

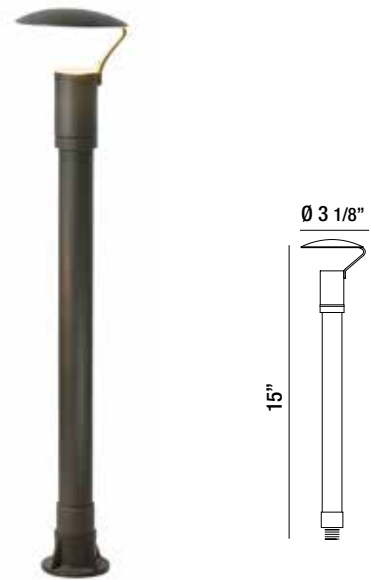

31944-014

- 3W LED
- 2700 Kelvin
- Lumen Output: 150lm
- Transformer not included
- IP 65
- CRI: 80+
- Solid brass body
- Antique bronze finish
- 3 feet of waterproof, copper core, PVC jacketed body, UV protected wire included
- 8" Stake included. For more mounting options, refer to page #35.





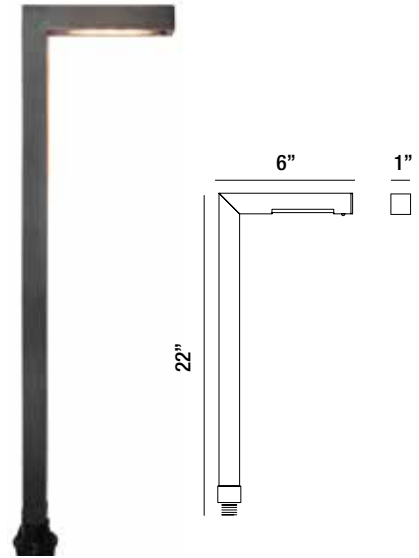

31945-011

- 3W LED
- 2700 Kelvin
- Lumen Output: 120lm
- Transformer not included
- IP 65
- CRI: 80+
- Solid brass body
- Antique bronze finish
- 3 feet of waterproof, copper core, PVC jacketed body, UV protected wire included
- 8" Stake included. For more mounting options, refer to page #35.

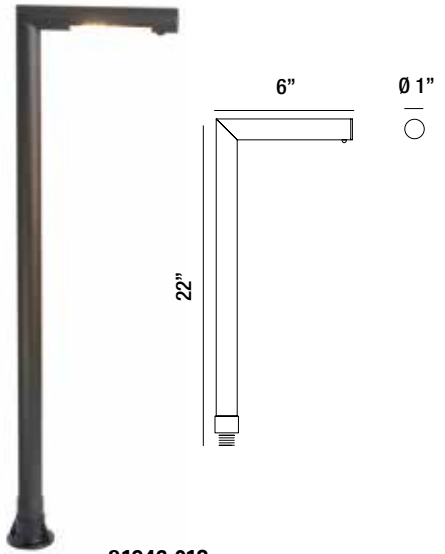

31946-018

- 3W LED
- 2700 Kelvin
- Lumen Output: 120lm
- Transformer not included
- IP 65
- CRI: 80+
- Solid brass body
- Antique bronze finish
- 3 feet of waterproof, copper core, PVC jacketed body, UV protected wire included
- 8" Stake included. For more mounting options, refer to page #35.



HARDSCAPE





31955-010

- 0.8W CREE LED
- 2700 Kelvin
- Lumen Output: 65lm
- IP 65
- CRI: 80+
- High corrosion resistant die-cast aluminum body
- Transformer not included
- Textured bronze finish



31956-017

- 0.8W CREE LED
- 3500 Kelvin
- Lumen Output: 65lm
- IP 65
- CRI: 80+
- High corrosion resistant die-cast aluminum body
- Transformer not included
- Textured bronze finish



31957-014

- 1.4W CREE LED
- 2700 Kelvin
- Lumen Output: 130lm
- IP 65
- CRI: 80+
- High corrosion resistant die-cast aluminum body
- Transformer not included
- Textured bronze finish



31958-011

- 1.4W CREE LED
- 3500 Kelvin
- Lumen Output: 130lm
- IP 65
- CRI: 80+
- High corrosion resistant die-cast aluminum body
- Transformer not included
- Textured bronze finish



ACCESSORIES



32397-16-100
32397-16-250
32397-16-500

100ft/250ft/500ft
 16 gauge landscape wire



32398-14-100
32398-14-250
32398-14-500

100ft/250ft/500ft
 14 gauge landscape wire



32399-12-100
32399-12-250
32399-12-500

100ft/250ft/500ft
 12 gauge landscape wire



31963-015

Blue waterproof
 wire connector
 Ø1.36" x H1"



31964-012

Black waterproof
 wire connector
 Ø1.36" x H1"



31965-019

Waterproof
 wire connector
 Ø1.5" x H1.13"



31966-016

7" Brass riser
 Solid brass



31967-013

12" Brass riser
 Solid brass



31968-010

18" Brass riser
 Solid brass



31976-015

Ø2" x 8" Stake



31961-011

Round casting mounting base
 with standard 1/2IPS thread
 solid brass



31962-018

Tree bracket
 with 1/2IPS thread
 solid brass

CHANGEABLE LENS



20°

31969-017

20 degree — narrow beam angle





60°

31970-013

60 degree — wide beam angle

TRANSFORMERS

	MODEL	WATTAGE	CASE MATERIAL	OUTPUT VOLTAGE	PHOTOCELL/TIMER	REMARK
	32356-014	100W	Plastic	12V	Included	Suitable for use with submersible luminaires or submersible pumps
	32357-011	150W	Plastic	12V	Included	Suitable for use with submersible luminaires or submersible pumps
	32359-015	300W	Stainless steel	12V/13V/14V/15V	with mechanical timer and remote photocell	Suitable for use with submersible luminaires or submersible pumps

PHOTOCELL/TIMER

	MODEL	CASE MATERIAL	OUTPUT VOLTAGE	REMARK
	32358-018	Plastic	120V AC	Suitable for use with submersible luminaires or submersible pumps



IN-GROUND







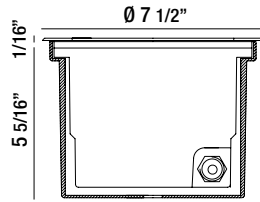

22520-012

- 5 X 1.5W CREE SUPER LED
- 3000 Kelvin
- Lumen Output: 720lm
- LED driver included
- Electronic driver 120V 50/60Hz
- IP 67
- Adjustable $\pm 15^\circ$
- CRI: 80+
- High corrosion resistant die-cast aluminum body
- Polyester painting with phospho-chromating pre-finish
- Stainless steel ring AISI 304
- Stainless steel screws
- Silicone rubber gasket
- Max static weight resistant 5000kg
- Polypropylene housing for recess included (concrete pour)
- 3 feet of waterproof, copper core, PVC jacketed body, UV protected wire included
- Tempered safety glass



MAX 5,000 kg



SPOT 10°

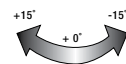

ADJUSTABLE

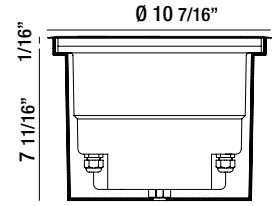

22521-019

- 8 X 1.5W CREE LED
- 3000 Kelvin
- Lumen Output: 1152lm
- IP 67
- LED driver included
- Electronic driver 120V 50/60Hz
- Adjustable $\pm 15^\circ$
- CRI: 80+
- High corrosion resistant die-cast aluminum body
- Polyester painting with phospho-chromating pre-finish
- Stainless steel ring AISI 304
- Stainless steel screws
- Silicone rubber gasket
- Max static weight resistant 5000kg
- Polypropylene housing for recess included (concrete pour)
- 3 feet of waterproof, copper core, PVC jacketed body, UV protected wire included
- Tempered safety glass



MAX 5,000 kg



SPOT 10°

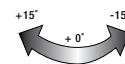

ADJUSTABLE

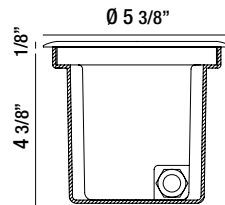

22518-019

- 3 X 1W LED
- 3000 Kelvin
- Lumen Output: 346lm
- LED driver included
- Electronic driver 120V 50/60Hz
- IP 67
- Adjustable $\pm 15^\circ$
- CRI: 80+
- High corrosion resistant die-cast aluminum body
- Polyester painting with phospho-chromating pre-finish
- Stainless steel ring AISI 304
- Stainless steel screws
- Silicone rubber gasket
- Max static weight resistant 5000kg
- Polypropylene housing for recess included (concrete pour)
- 3 feet of waterproof, copper core, PVC jacketed body, UV protected wire included
- Tempered safety glass



MAX 5,000 kg



SPOT 10°

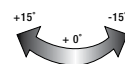

ADJUSTABLE

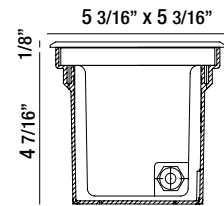

22523-013

- 3 X 1W LED
- 3000 Kelvin
- Lumen Output: 346lm
- LED driver included
- Electronic driver 120V 50/60Hz
- IP 67
- Adjustable $\pm 15^\circ$
- CRI: 80+
- High corrosion resistant die-cast aluminum body
- Polyester painting with phospho-chromating pre-finish
- Stainless steel ring AISI 304
- Stainless steel screws
- Silicone rubber gasket
- Max static weight resistant 5000kg
- Polypropylene housing for recess included (concrete pour)
- 3 feet of waterproof, copper core, PVC jacketed body, UV protected wire included
- Tempered safety glass



MAX 5,000 kg



SPOT 10°

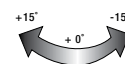

ADJUSTABLE

MADE IN ITALY





23815-018

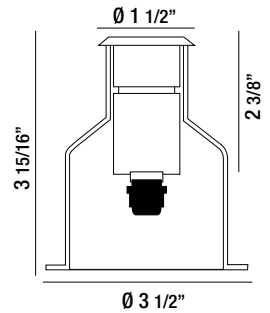

- 1 X 1W LED
- 3000 Kelvin
- Lumen Output: 96lm
- Driver not included 24V DC
- IP 67
- CRI: 80+
- High corrosion resistant die-cast aluminum body
- Polyester painting with phospho-chromating pre-finish
- Stainless steel ring AISI 304
- Stainless steel screws
- Max static weight resistant 1000kg
- Polypropylene housing for recess included (concrete pour)
- 3 feet of waterproof, copper core, PVC jacketed body, UV protected wire included
- Tempered safety glass



SPOT 25°

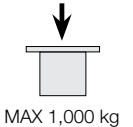

MAX 1,000 kg



23816-015

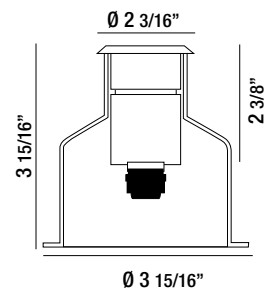

- 3 x 1W CREE SUPER LED
- 3000 Kelvin
- Lumen Output: 288lm
- Driver not included 24V DC
- IP 67
- CRI: 80+
- High corrosion resistant die-cast aluminum body
- Polyester painting with phospho-chromating pre-finish
- Stainless steel ring AISI 304
- Stainless steel screws
- Max static weight resistant 1000kg
- Polypropylene housing for recess included (concrete pour)
- 3 feet of waterproof, copper core, PVC jacketed body, UV protected wire included
- Tempered safety glass



SPOT 25°

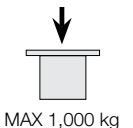

MAX 1,000 kg





IG-01-S5

- MR16 35W max
- 12V
- Transformer not included
- IP 67
- Adjustable $\pm 15^\circ$
- High corrosion resistant die-cast aluminum body
- Polyester painting with phospho-chromating pre-finish
- Stainless steel ring AISI 304
- Stainless steel screws
- Silicone rubber gasket
- Max static weight resistant 5000kg
- Polypropylene housing for recess included (concrete pour)
- 3 feet of waterproof, copper core, PVC jacketed body, UV protected wire included
- Tempered safety glass

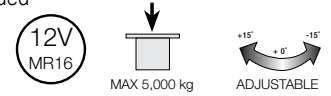
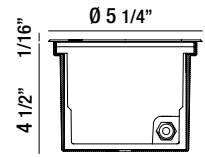

IG-02-S5

- MR16 35W max
- 12V
- Transformer not included
- IP 67
- Adjustable $\pm 15^\circ$
- High corrosion resistant die-cast aluminum body
- Polyester painting with phospho-chromating pre-finish
- Stainless steel ring AISI 304
- Stainless steel screws
- Silicone rubber gasket
- Max static weight resistant 5000kg
- Polypropylene housing for recess included (concrete pour)
- 3 feet of waterproof, copper core, PVC jacketed body, UV protected wire included
- Tempered safety glass

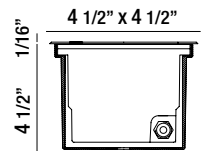

23817-012

- GU10 35W max
- 120V
- IP 67
- High corrosion resistant stainless steel body
- Stainless steel ring AISI 316
- Clear tempered glass
- Stainless steel screws
- Silicon rubber gasket
- Max static weight resistant 5000kg
- Protection against impact IK09 [10 joules]
- M20 cable gland
- Polypropylene housing for recess included (concrete pour)
- 3 feet of waterproof, copper core, PVC jacketed body, UV protected wire included
- Tempered safety glass

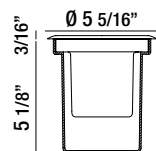

42 | IN-GROUND



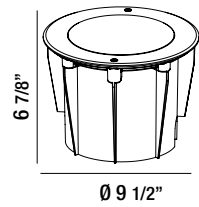

32188-011

- 24 x 1W CREE SUPER LED
- 3000 Kelvin
- Lumen Output: 905lm
- LED driver included
- Electronic driver 120V 50/60Hz
- IP 67
- CRI: 80+
- High corrosion resistant die-cast aluminum body
- Polyester painting with phospho-chromating pre-finish
- Stainless steel ring AISI 304
- Stainless steel screws
- Silicone rubber gasket
- Max static weight resistant 500kg
- Polypropylene housing for recess included (concrete pour)
- 3 feet of waterproof, copper core, PVC jacketed body, UV protected wire included
- Tempered safety glass

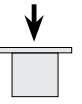

MAX 500 kg



SPOT 30°





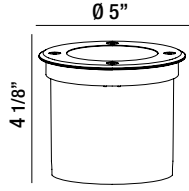

32189-018

- 1 x 7W CREE LED
- 3000 Kelvin
- Lumen Output: 473lm
- LED driver included
- Electronic driver 120V 50/60Hz
- IP 67
- CRI: 80+
- High corrosion resistant die-cast aluminum body
- Polyester painting with phospho-chromating pre-finish
- Stainless steel ring AISI 304
- Stainless steel screws
- Silicone rubber gasket
- Max static weight resistant 500kg
- Polypropylene housing for recess included (concrete pour)
- 3 feet of waterproof, copper core, PVC jacketed body, UV protected wire included
- Tempered safety glass



SPOT 25°

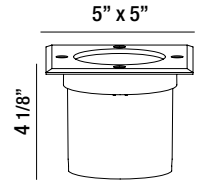

32190-014

- 1 x 7W CREE LED
- 3000 Kelvin
- Lumen Output: 473lm
- LED driver included
- Electronic driver 120V 50/60Hz
- IP 67
- CRI: 80+
- High corrosion resistant die-cast aluminum body
- Polyester painting with phospho-chromating pre-finish
- Stainless steel ring AISI 304
- Stainless steel screws
- Silicone rubber gasket
- Max static weight resistant 500kg
- Polypropylene housing for recess included (concrete pour)
- 3 feet of waterproof, copper core, PVC jacketed body, UV protected wire included
- Tempered safety glass

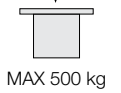

SPOT 25°

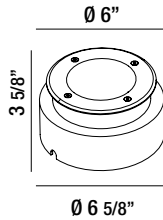

32191-011

- 6 x 1W OSRAM LED
- 3000 Kelvin
- Lumen Output: 443lm
- LED driver included
- Electronic driver 120V 50/60Hz
- IP 67
- CRI: 80+
- High corrosion resistant die-cast aluminum body
- Polyester painting with phospho-chromating pre-finish
- Stainless steel ring AISI 304
- Stainless steel screws
- Silicone rubber gasket
- Max static weight resistant 500kg
- Polypropylene housing for recess included
- Polypropylene housing for recess included (concrete pour)
- 3 feet of waterproof, copper core, PVC jacketed body, UV protected wire included
- Tempered safety glass

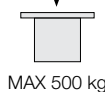

SPOT 25°

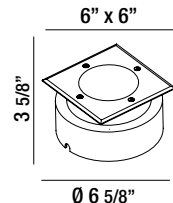

32192-018

- 6 x 1W OSRAM LED
- 3000 Kelvin
- Lumen Output: 443lm
- LED driver included
- Electronic driver 120V 50/60Hz
- IP 67
- CRI: 80+
- High corrosion resistant die-cast aluminum body
- Polyester painting with phospho-chromating pre-finish
- Stainless steel ring AISI 304
- Stainless steel screws
- Silicone rubber gasket
- Max static weight resistant 500kg
- Polypropylene housing for recess included (concrete pour)
- 3 feet of waterproof, copper core, PVC jacketed body, UV protected wire included
- Tempered safety glass

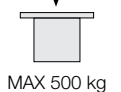

SPOT 25°

— IN-GROUND





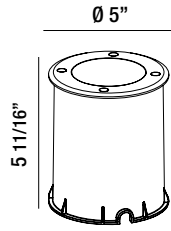

31595-018

- 3 x 2W CREE LED
- 3000 Kelvin
- Lumen Output: 270lm
- LED driver included
- Electronic driver 120V 50/60Hz
- IP 67
- CRI: 80+
- Adjustable $\pm 15^\circ$
- High corrosion resistant die-cast aluminum body
- Polyester painting with phospho-chromating pre-finish
- Stainless steel ring AISI 304
- Stainless steel screws
- Silicone rubber gasket
- Max static weight resistant 500kg
- Polypropylene housing for recess included (concrete pour)
- 3 feet of waterproof, copper core, PVC jacketed body, UV protected wire included
- Tempered safety glass

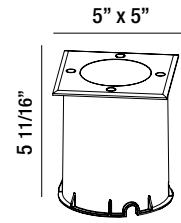

31596-015

- 3 x 2W CREE LED
- 3000 Kelvin
- Lumen Output: 270lm
- LED driver included
- Electronic driver 120V 50/60Hz
- IP 67
- CRI: 80+
- Adjustable $\pm 15^\circ$
- High corrosion resistant die-cast aluminum body
- Polyester painting with phospho-chromating pre-finish
- Stainless steel ring AISI 304
- Stainless steel screws
- Silicone rubber gasket
- Max static weight resistant 500kg
- Polypropylene housing for recess included (concrete pour)
- 3 feet of waterproof, copper core, PVC jacketed body, UV protected wire included
- Tempered safety glass

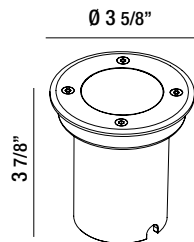
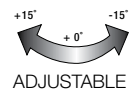
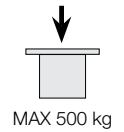

32193-015

- 3 x 1W CREE LED
- 3000 Kelvin
- Lumen Output: 175lm
- LED driver included
- Electronic driver 120V 50/60Hz
- IP 67
- CRI: 80+
- High corrosion resistant die-cast aluminum body
- Polyester painting with phospho-chromating pre-finish
- Stainless steel ring AISI 304
- Stainless steel screws
- Silicone rubber gasket
- Max static weight resistant 500kg
- Polypropylene housing for recess included (concrete pour)
- 3 feet of waterproof, copper core, PVC jacketed body, UV protected wire included
- Tempered safety glass

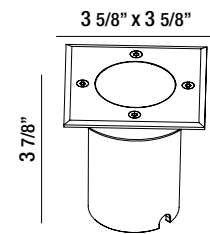
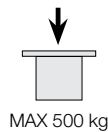

32194-012

- 3 x 1W CREE LED
- 3000 Kelvin
- Lumen Output: 175lm
- LED driver included
- Electronic driver 120V 50/60Hz
- IP 67
- CRI: 80+
- High corrosion resistant die-cast aluminum body
- Polyester painting with phospho-chromating pre-finish
- Stainless steel ring AISI 304
- Stainless steel screws
- Silicone rubber gasket
- Max static weight resistant 500kg
- Polypropylene housing for recess included (concrete pour)
- 3 feet of waterproof, copper core, PVC jacketed body, UV protected wire included
- Tempered safety glass

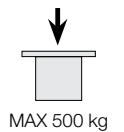



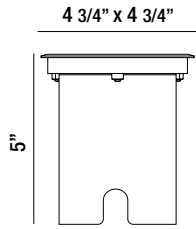

14755-019

- MR16 50W max
- 12V
- Transformer not included
- IP 67
- High corrosion resistant die-cast aluminum body
- Polyester painting with phospho-chromating pre-finish
- Stainless steel ring AISI 304
- Stainless steel screws
- Silicone rubber gasket
- Max static weight resistant 500kg
- Polypropylene housing for recess included (concrete pour)
- 3 feet of waterproof, copper core, PVC jacketed body, UV protected wire included
- Tempered safety glass

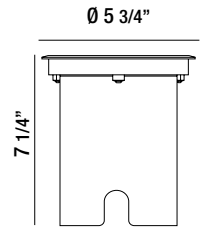

14754-012

- MR16 50W max
- 12V
- Transformer not included
- IP 67
- High corrosion resistant die-cast aluminum body
- Polyester painting with phospho-chromating pre-finish
- Stainless steel ring AISI 304
- Stainless steel screws
- Silicone rubber gasket
- Max static weight resistant 500kg
- Polypropylene housing for recess included (concrete pour)
- 3 feet of waterproof, copper core, PVC jacketed body, UV protected wire included
- Tempered safety glass

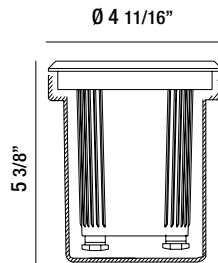

19552-019

- GU10 50W max
- 120V
- IP 67
- High corrosion resistant die-cast aluminum body
- Polyester painting with phospho-chromating pre-finish
- Stainless steel ring AISI 304
- Stainless steel screws
- Silicone rubber gasket
- Max static weight resistant 500kg
- Polypropylene housing for recess included (concrete pour)
- 3 feet of waterproof, copper core, PVC jacketed body, UV protected wire included
- Tempered safety glass

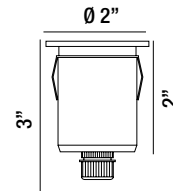
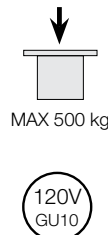

14746-017

- 3 X 1W EDISON LED
- 3000 Kelvin
- Total Lumen Output: 150lm
- LED driver included
- Electronic driver 120V 50/60Hz
- IP 67
- CRI: 80+
- High corrosion resistant die-cast aluminum body
- Polyester painting with phospho-chromating pre-finish
- Stainless steel ring AISI 304
- Silicone rubber gasket
- Max static weight resistant 500kg
- Polypropylene housing for recess included (concrete pour)
- 10 feet of waterproof, copper core, PVC jacketed body, UV protected wire included
- Tempered safety glass

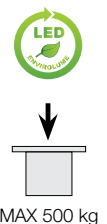

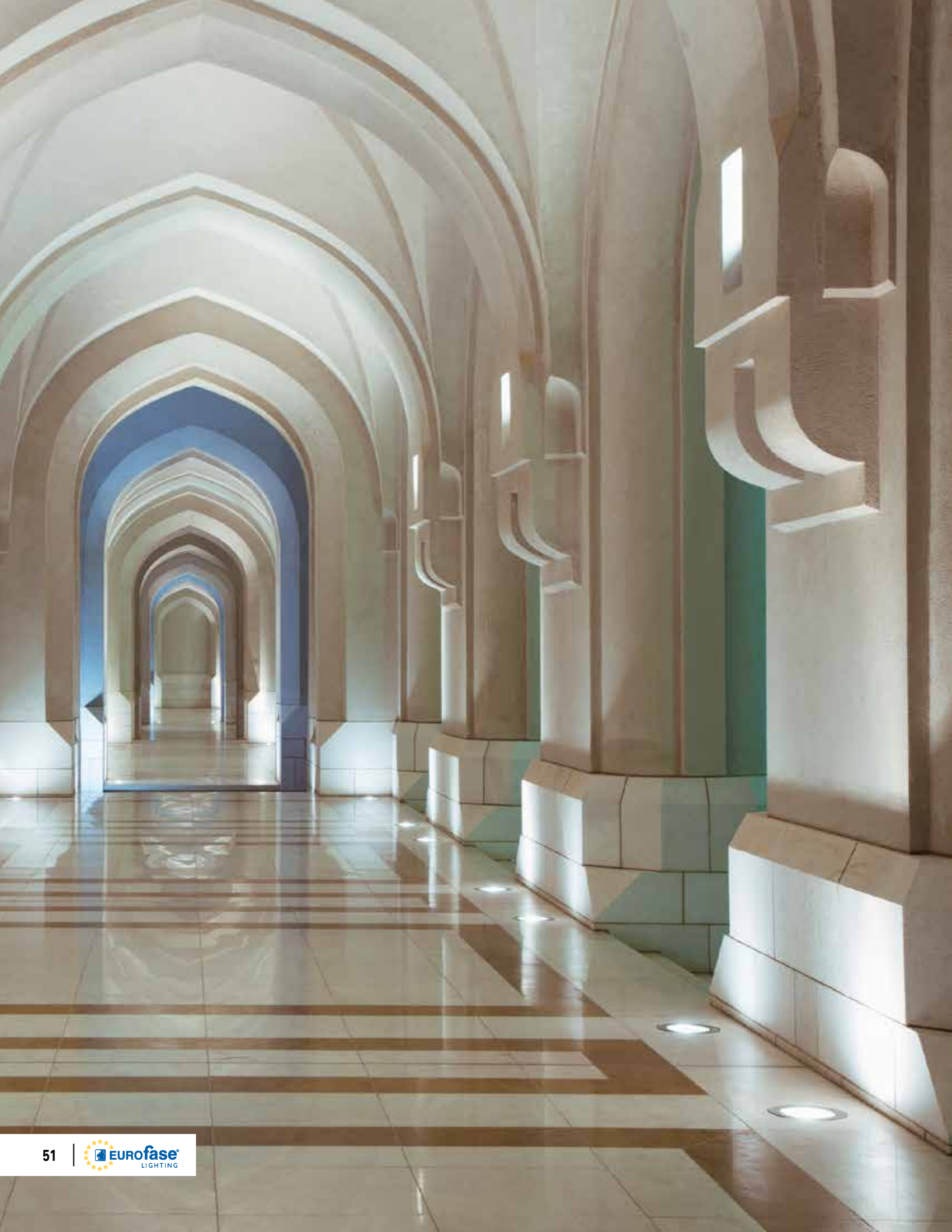

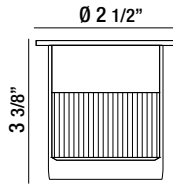

32097-016

- 1 X 4.5W OSRAM LED
- 3000 Kelvin
- Lumen Output: 250lm
- Driver not included 12V AD/DC
- IP 67
- CRI: 80+
- High corrosion resistant die-cast aluminum body
- Polyester painting with phospho-chromating pre-finish
- Silicone rubber gasket
- Polypropylene housing for recess included (concrete pour)
- 3 feet of waterproof, copper core, PVC jacketed body, UV protected wire included
- Tempered safety glass



SPOT 25°



MAX 100 kg

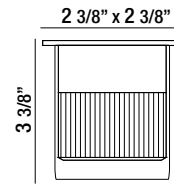

32098-013

- 1 X 4.5W OSRAM LED
- 3000 Kelvin
- Lumen Output: 250lm
- Driver not included 12V AC/DC
- IP 67
- CRI: 80+
- High corrosion resistant die-cast aluminum body
- Polyester painting with phospho-chromating pre-finish
- Silicone rubber gasket
- Polypropylene housing for recess included (concrete pour)
- 3 feet of waterproof, copper core, PVC jacketed body, UV protected wire included
- Tempered safety glass



SPOT 25°



MAX 100 kg

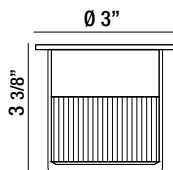

32099-010

- 1 X 10W OSRAM LED
- 3000 Kelvin
- Lumen Output: 750lm
- Driver not included 12V AC/DC
- IP 67
- CRI: 80+
- High corrosion resistant die-cast aluminum body
- Polyester painting with phospho-chromating pre-finish
- Silicone rubber gasket
- Polypropylene housing for recess included (concrete pour)
- 3 feet of waterproof, copper core, PVC jacketed body, UV protected wire included
- Tempered safety glass



SPOT 25°



MAX 100 kg

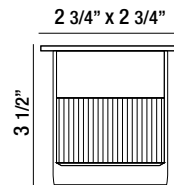

32100-013

- 1 X 10W OSRAM LED
- 3000 Kelvin
- Lumen Output: 750lm
- Driver not included 12V AC/DC
- IP 67
- CRI: 80+
- High corrosion resistant die-cast aluminum body
- Polyester painting with phospho-chromating pre-finish
- Silicone rubber gasket
- Polypropylene housing for recess included (concrete pour)
- 3 feet of waterproof, copper core, PVC jacketed body, UV protected wire included
- Tempered safety glass



SPOT 25°



MAX 100 kg



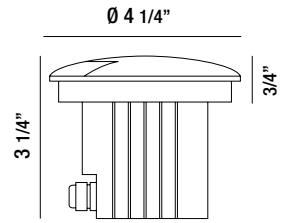

14750-014

- 1 X 1W OSRAM LED
- 3000 Kelvin
- Lumen Output: 80lm
- LED driver included
- Electronic driver 120V 50/60Hz
- IP 67
- Single direction marker light
- Polycarbonate lens
- Powder coated finish
- High corrosion resistant die-cast aluminum body
- Polypropylene housing for recess included (concrete pour)
- 3 feet of waterproof, copper core, PVC jacketed body, UV protected wire included

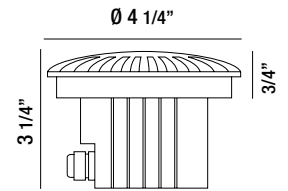

14749-018

- 1 X 1W OSRAM LED
- 3000 Kelvin
- Lumen Output: 80lm
- LED driver included
- Electronic driver 120V 50/60Hz
- IP 67
- Multi direction marker light
- Polycarbonate lens
- Powder coated finish
- High corrosion resistant die-cast aluminum body
- Polypropylene housing for recess included (concrete pour)
- 3 feet of waterproof, copper core, PVC jacketed body, UV protected wire included

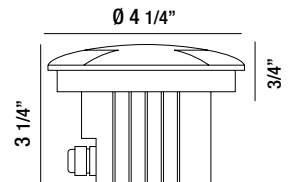

14748-011

- 1 X 1W OSRAM LED
- 3000 Kelvin
- Lumen Output: 750lm
- LED driver included
- Electronic driver 120V 50/60Hz
- IP 67
- Dual direction marker light
- Polycarbonate lens
- Powder coated finish
- High corrosion resistant die-cast aluminum body
- Polypropylene housing for recess included (concrete pour)
- 3 feet of waterproof, copper core, PVC jacketed body, UV protected wire included



FLOOD LIGHT



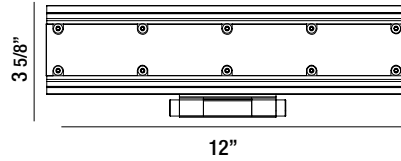

22534-019

- 12 x 1W LED flood light
- 3000 Kelvin
- Lumen Output: 852lm
- Built-in LED driver
- IP 66
- CRI: 80+
- High corrosion resistant die-cast aluminum body
- Stainless steel screws
- Silicone rubber gasket
- Tempered safety glass
- Powder coated finish



I/P: 100V-240V
Power

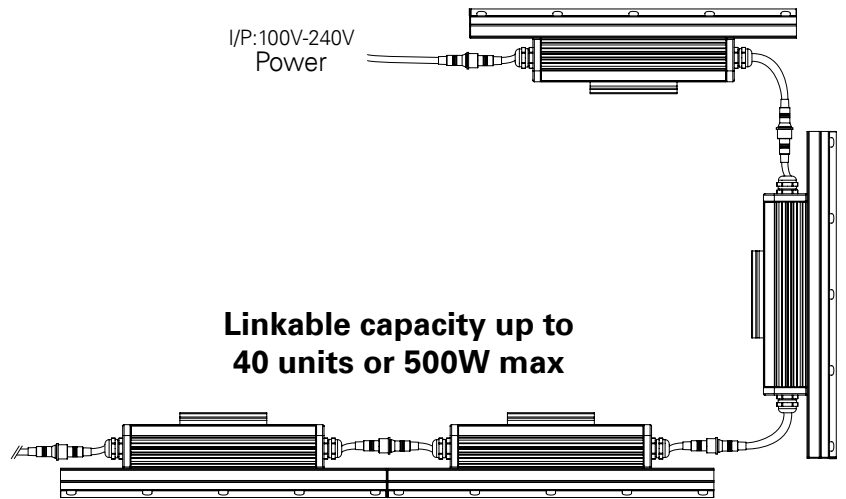

24424-011

43" DOUBLE END PLUG-IN CONNECTOR CABLE



DECK LIGHT

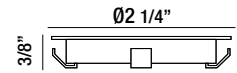

32093-018

- 6 x 0.5W LED deck light
- 3000 Kelvin
- Total Lumen Output: 42lm
- LED driver included
- Electronic driver 120V 50/60Hz
- IP 67
- CRI: 80+
- With 36" wire lead and quick connector
- Max static weight resistant 100kg
- High corrosion resistant stainless steel body
- Tempered safety glass



120°

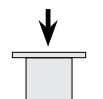

MAX 100 kg

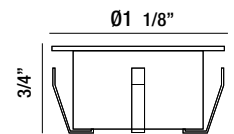

32094-015

- 6 x 0.6W LED deck light
- 3000 Kelvin
- Total Lumen Output: 54lm
- LED driver included
- Electronic driver 120V 50/60Hz
- IP 67
- CRI: 80+
- With 36" wire lead and quick connector
- Max static weight resistant 100kg
- High corrosion resistant stainless steel body
- Tempered safety glass

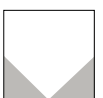

120°

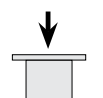

MAX 100 kg

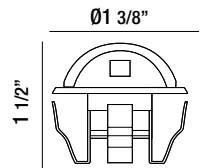

32095-012

- 6 x 0.4W LED deck step light
- 3000 Kelvin
- Total Lumen Output: 60lm
- LED driver included
- Electronic driver 120V 50/60Hz
- IP 67
- CRI: 80+
- With 36" wire lead and quick connector
- High corrosion resistant stainless steel body
- Tempered safety glass

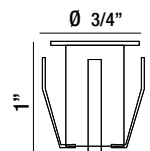

32096-019

- 10 x 0.4W LED deck light
- 3000 Kelvin
- Total Lumen Output: 70lm
- LED driver included
- Electronic driver 120V 50/60Hz
- IP 67
- CRI: 80+
- With 36" wire lead and quick connector
- Max static weight resistant 100kg
- High corrosion resistant stainless steel body
- Tempered safety glass

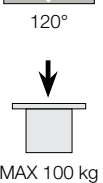

LED SCONCE/SIGN





LED SCONCE/SIGN

- Aluminum powder coated finish
- Acrylic clear plate allows custom laser engraved text
- Integral LED driver 120V 50/60Hz

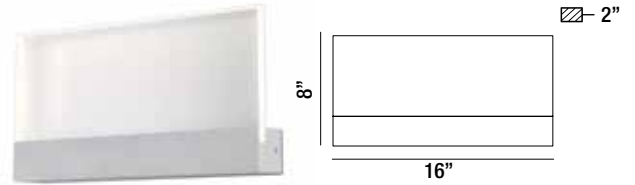

31437-011

LARGE LED OUTDOOR SIGN
6 x 1W/LED 4000K/600lm
(dimnable)

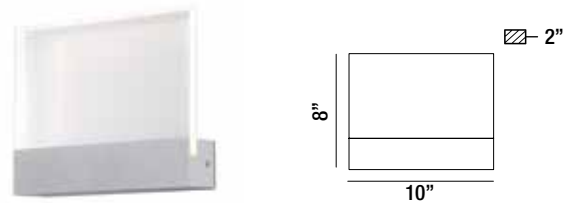

31436-014

MEDIUM LED OUTDOOR SIGN
4 x 1W/LED 4000K/400lm
(dimnable)



31435-017

SMALL LED OUTDOOR SIGN
3 x 1W/LED 4000K/300lm
(dimnable)

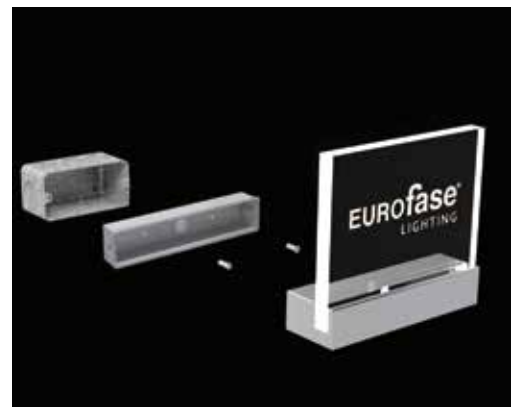

**MOUNTS IN STANDARD 2" X 3" SWITCH BOX
(NOT INCLUDED)**

*** CONTACT EUROFASE FOR CUSTOM DESIGNS**



OUTDOOR

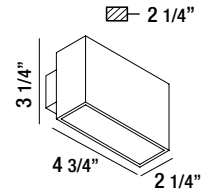
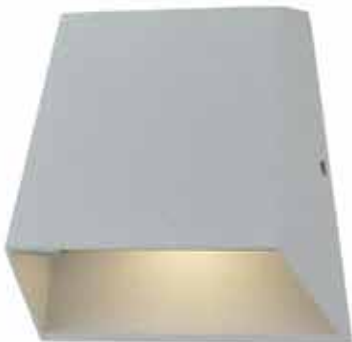

28282-013 MARINE GREY
28282-020 GRAPHITE GREY

- 1 X 5W CREE LED
- 3000 Kelvin
- Lumen Output: 150lm
- LED driver included
- Electronic driver 120V 50/60Hz
- IP 54
- CRI: 80+
- High corrosion resistant die-cast aluminum body
- Stainless steel screws
- Silicone rubber gasket
- Powder coated with pretreatment for outdoor use
- Patented design
- Cover plate included for standard junction box



up & down light

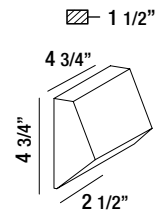

28281-016 MARINE GREY
28281-023 GRAPHITE GREY

- 1 X 7W CREE LED
- 3000 Kelvin
- Lumen Output: 330lm
- LED driver included
- Electronic driver 120V 50/60Hz
- IP 54
- CRI: 80+
- High corrosion resistant die-cast aluminum body
- Stainless steel screws
- Silicone rubber gasket
- Powder coated with pretreatment for outdoor use
- Patented design
- Cover plate included for standard junction box



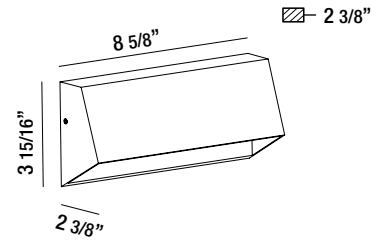

31589-017 MARINE GREY
31589-024 GRAPHITE GREY

- 4 X 1W CREE LED
- 3000 Kelvin
- Lumen Output: 160lm
- LED driver included
- Electronic driver 120V 50/60Hz
- IP 54
- CRI: 80+
- High corrosion resistant die-cast aluminum body
- Stainless steel screws
- Silicone rubber gasket
- Powder coated with pretreatment for outdoor use
- Patented design
- Cover plate included for standard junction box

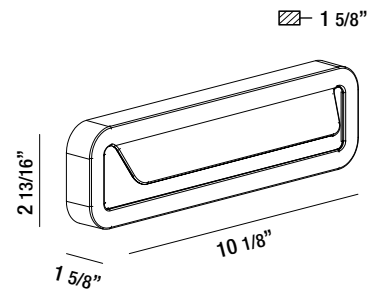

31577-014 MARINE GREY
31577-021 GRAPHITE GREY

- 14W CREE LED
- 3000 Kelvin
- Lumen Output: 360lm
- LED driver included
- Electronic driver 120V 50/60Hz
- IP 54
- CRI: 80+
- High corrosion resistant die-cast aluminum body
- Stainless steel screws
- Silicone rubber gasket
- Powder coated with pretreatment for outdoor use
- Patented design
- Cover plate included for standard junction box



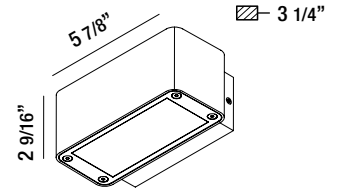

31581-011 MARINE GREY
31581-028 GRAPHITE GREY

- 4 X 3W CREE LED
- 3000 Kelvin
- Lumen Output: 385lm
- LED driver included
- Electronic driver 120V 50/60Hz
- IP 54
- CRI: 80+
- High corrosion resistant die-cast aluminum body
- Stainless steel screws
- Silicone rubber gasket
- Powder coated with pretreatment for outdoor use
- Patented design
- Cover plate included for standard junction box

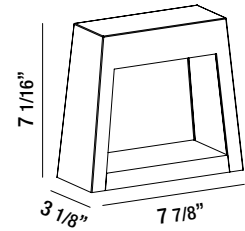

31574-013 MARINE GREY
31574-020 GRAPHITE GREY

- 1 X 18W CREE LED
- 3000 Kelvin
- Lumen Output: 570lm
- LED driver included
- Electronic driver 120V 50/60Hz
- IP 54
- CRI: 80+
- High corrosion resistant die-cast aluminum body
- Stainless steel screws
- Silicone rubber gasket
- Powder coated with pretreatment for outdoor use
- Patented design
- Cover plate included for standard junction box



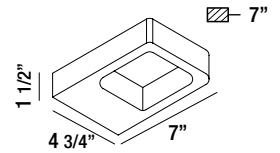
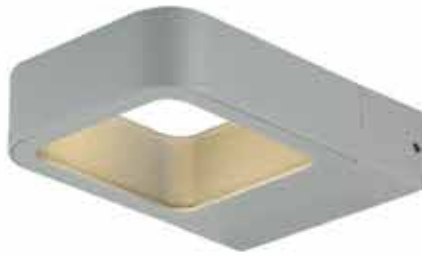
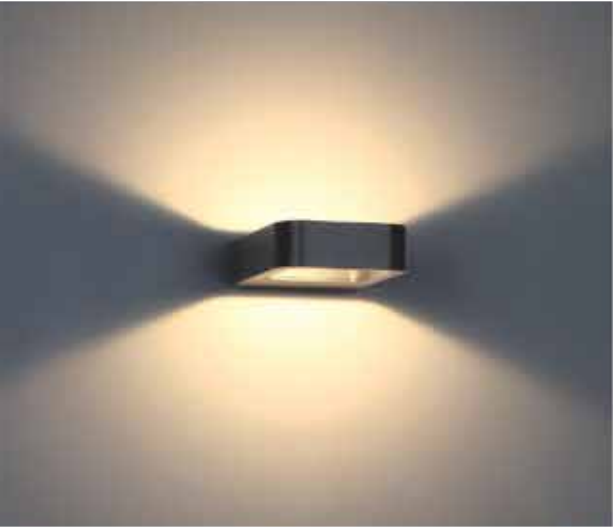
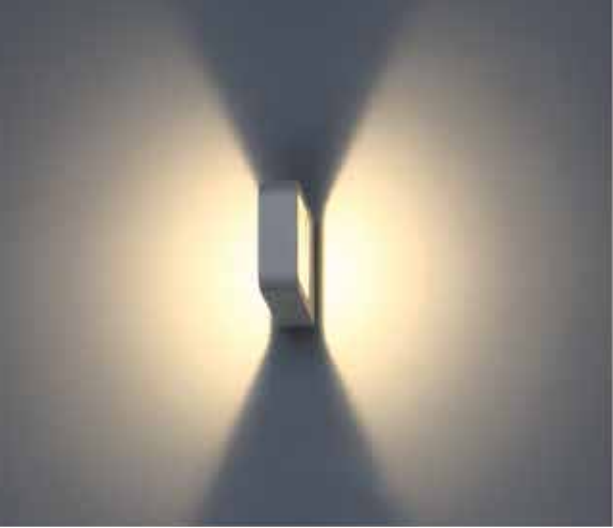

28293-019 MARINE GREY
28293-026 GRAPHITE GREY

- 1 X 7W CREE LED
- 3000 Kelvin
- Lumen Output: 240lm
- LED driver included
- Electronic driver 120V 50/60Hz
- IP 54
- CRI: 80+
- High corrosion resistant die-cast aluminum body
- Stainless steel screws
- Silicone rubber gasket
- Powder coated with pretreatment for outdoor use
- Patented design
- Cover plate included for standard junction box

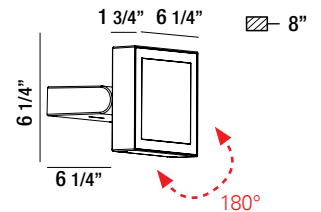

28288-015 MARINE GREY
28288-022 GRAPHITE GREY

- 16 X 1W CREE LED
- 3000 Kelvin
- Lumen Output: 1000lm
- LED driver included
- Electronic driver 120V 50/60Hz
- IP 54
- CRI: 80+
- High corrosion resistant die-cast aluminum body
- Stainless steel screws
- Silicone rubber gasket
- Powder coated with pretreatment for outdoor use
- Patented design
- Cover plate included for standard junction box



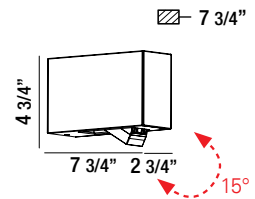

28280-019 MARINE GREY
28280-026 GRAPHITE GREY

- 3 X 3W CREE LED
- 3000 Kelvin
- Lumen Output: 260lm
- LED driver included
- Electronic driver 120V 50/60Hz
- IP 54
- CRI: 80+
- High corrosion resistant die-cast aluminum body
- Stainless steel screws
- Silicone rubber gasket
- Powder coated with pretreatment for outdoor use
- Patented design
- Cover plate included for standard junction box



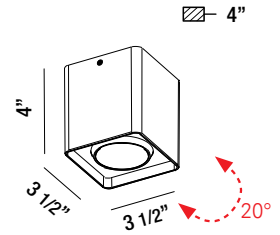

31578-011 MARINE GREY
31578-028 GRAPHITE GREY

- 1 X 9W CREE LED
- 3000 Kelvin
- Lumen Output: 650lm
- LED driver included
- Electronic driver 120V 50/60Hz
- IP 54
- CRI: 80+
- High corrosion resistant die-cast aluminum body
- Stainless steel screws
- Silicone rubber gasket
- Powder coated with pretreatment for outdoor use
- Patented design
- Cover plate included for standard junction box

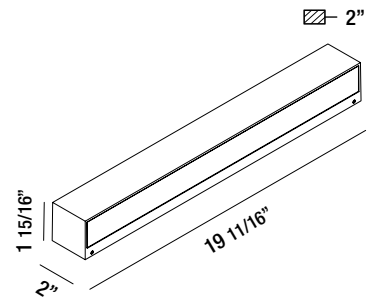

31579-018 MARINE GREY
31579-025 GRAPHITE GREY

- 36W CREE LED
- 3000 Kelvin
- Lumen Output: 2232lm
- LED driver included
- Electronic driver 120V 50/60Hz
- IP 54
- CRI: 80+
- High corrosion resistant die-cast aluminum body
- Stainless steel screws
- Silicone rubber gasket
- Powder coated with pretreatment for outdoor use
- Patented design
- Cover plate included for standard junction box



up & down light



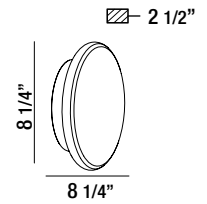

28289-012 MARINE GREY
28289-029 GRAPHITE GREY

- 10 X 1W CREE LED
- 3000 Kelvin
- Lumen Output: 360lm
- LED driver included
- IP 54
- CRI: 80+
- High corrosion resistant die-cast aluminum body
- Stainless steel screws
- Electronic driver 120V 50/60Hz
- Silicone rubber gasket
- Powder coated with pretreatment for outdoor use
- Patented design
- Cover plate included for standard junction box

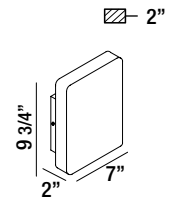

28275-015 MARINE GREY
28275-022 GRAPHITE GREY

- 10 X 1W CREE LED
- 3000 Kelvin
- Lumen Output: 420lm
- LED driver included
- Electronic driver 120V 50/60Hz
- IP 54
- CRI: 80+
- High corrosion resistant die-cast aluminum body
- Stainless steel screws
- Silicone rubber gasket
- Powder coated with pretreatment for outdoor use
- Patented design
- Cover plate included for standard junction box



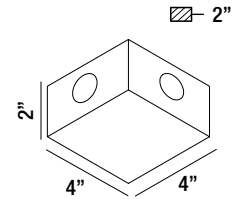

28297-017 MARINE GREY
28297-024 GRAPHITE GREY

- 4 X 1W CREE LED
- 3000 Kelvin
- Lumen Output: 320lm
- LED driver included
- Electronic driver 120V 50/60Hz
- IP 54
- CRI: 80+
- High corrosion resistant die-cast aluminum body
- Stainless steel screws
- Silicone rubber gasket
- Powder coated with pretreatment for outdoor use
- Patented design
- Cover plate included for standard junction box

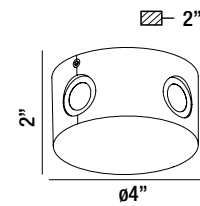

28296-010 MARINE GREY
28296-027 GRAPHITE GREY

- 4 X 1W CREE LED
- 3000 Kelvin
- Lumen Output: 320lm
- LED driver included
- Electronic driver 120V 50/60Hz
- IP 54
- CRI: 80+
- High corrosion resistant die-cast aluminum body
- Stainless steel screws
- Silicone rubber gasket
- Powder coated with pretreatment for outdoor use
- Patented design
- Cover plate included for standard junction box



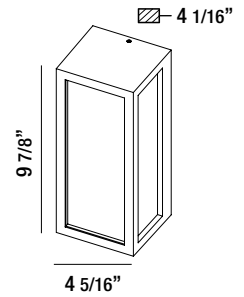

31580-014 MARINE GREY
31580-021 GRAPHITE GREY

- 18W CREE LED
- 3000 Kelvin
- Lumen Output: 662lm
- LED driver included
- Electronic driver 120V 50/60Hz
- IP 54
- CRI: 80+
- High corrosion resistant die-cast aluminum body
- Stainless steel screws
- Silicone rubber gasket
- Powder coated with pretreatment for outdoor use
- Patented design
- Cover plate included for standard junction box

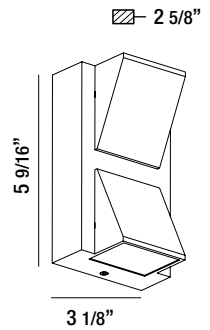

31582-018 MARINE GREY
31582-025 GRAPHITE GREY

- 2 X 3W CREE LED
- 3000 Kelvin
- Lumen Output: 160lm
- LED driver included
- Electronic driver 120V 50/60Hz
- IP 54
- CRI: 80+
- High corrosion resistant die-cast aluminum body
- Stainless steel screws
- Silicone rubber gasket
- Powder coated with pretreatment for outdoor use
- Patented design
- Cover plate included for standard junction box



up & down light



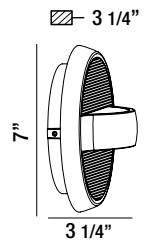

28274-018 MARINE GREY
28274-025 GRAPHITE GREY

- 1 X 7W CREE LED
- 3000 Kelvin
- Lumen Output: 220lm
- LED driver included
- Electronic driver 120V 50/60Hz
- IP 54
- CRI: 80+
- High corrosion resistant die-cast aluminum body
- Stainless steel screws
- Silicone rubber gasket
- Powder coated with pretreatment for outdoor use
- Patented design
- Cover plate included for standard junction box

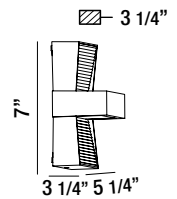

28279-013 MARINE GREY
28279-020 GRAPHITE GREY

- 1 X 7W CREE LED
- 3000 Kelvin
- Lumen Output: 160lm
- LED driver included
- Electronic driver 120V 50/60Hz
- IP 54
- CRI: 80+
- High corrosion resistant die-cast aluminum body
- Stainless steel screws
- Silicone rubber gasket
- Powder coated with pretreatment for outdoor use
- Patented design
- Cover plate included for standard junction box



70 | SURFACE MOUNT



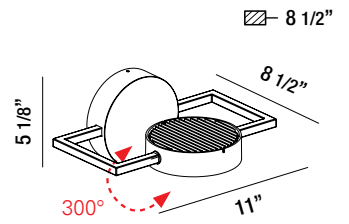

31585-019 MARINE GREY
31585-026 GRAPHITE GREY

- 15W CREE LED
- 3000 Kelvin
- Lumen Output: 740lm
- LED driver included
- Electronic driver 120V 50/60Hz
- IP 54
- CRI: 80+
- High corrosion resistant die-cast aluminum body
- Stainless steel screws
- Silicone rubber gasket
- Powder coated with pretreatment for outdoor use
- Patented design
- Cover plate included for standard junction box



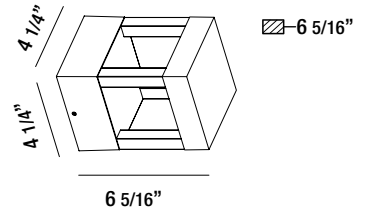
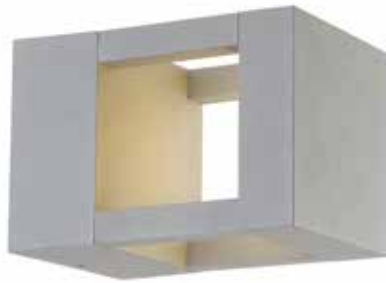
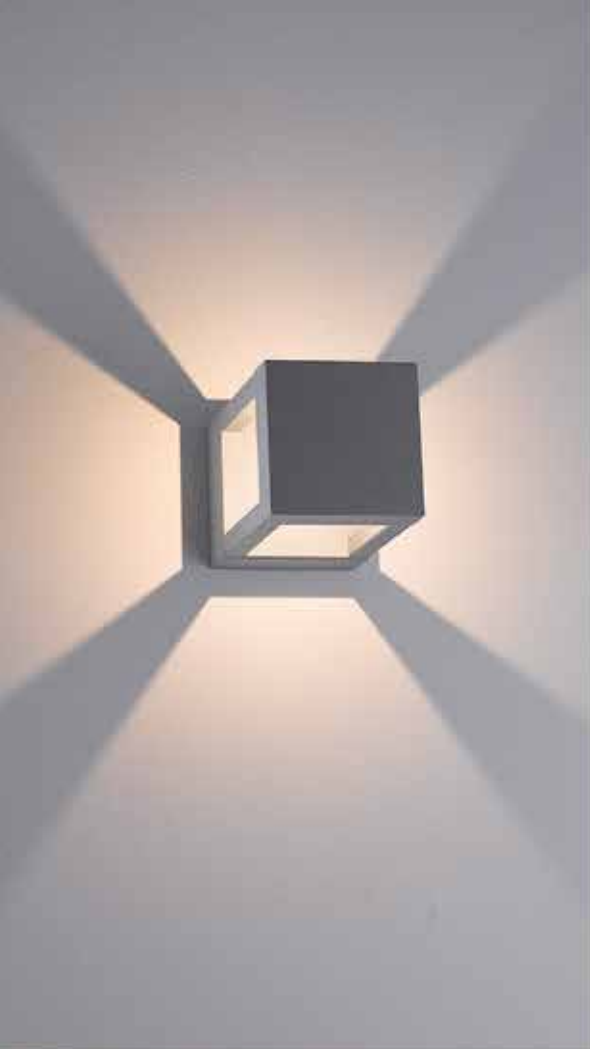

31587-013 MARINE GREY
31587-020 GRAPHITE GREY

- 1 X 7W CREE LED
- 3000 Kelvin
- Lumen Output: 350lm
- LED driver included
- Electronic driver 120V 50/60Hz
- IP 54
- CRI: 80+
- High corrosion resistant die-cast aluminum body
- Stainless steel screws
- Silicone rubber gasket
- Powder coated with pretreatment for outdoor use
- Patented design
- Cover plate included for standard junction box

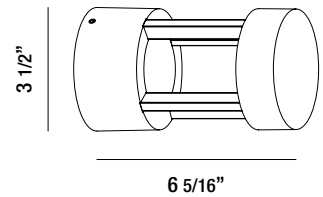

31586-016 MARINE GREY
31586-023 GRAPHITE GREY

- 1 X 7W CREE LED
- 3000 Kelvin
- Lumen Output: 350lm
- LED driver included
- Electronic driver 120V 50/60Hz
- IP 54
- CRI: 80+
- High corrosion resistant die-cast aluminum body
- Stainless steel screws
- Silicone rubber gasket
- Powder coated with pretreatment for outdoor use
- Patented design
- Cover plate included for standard junction box

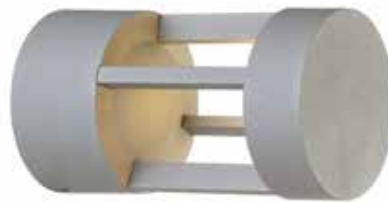

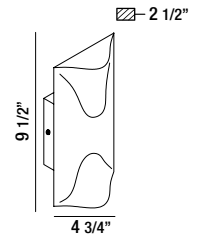

28278-016 MARINE GREY
28278-023 GRAPHITE GREY

- 2 X 7W CREE LED
- 3000 Kelvin
- Lumen Output: 570lm
- LED driver included
- Electronic driver 120V 50/60Hz
- IP 54
- CRI: 80+
- High corrosion resistant die-cast aluminum body
- Stainless steel screws
- Silicone rubber gasket
- Powder coated with pretreatment for outdoor use
- Patented design
- Cover plate included for standard junction box

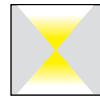

up & down light

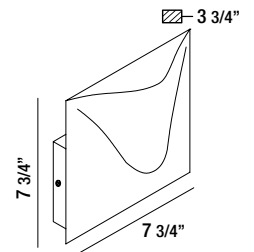

28277-019 MARINE GREY
28277-026 GRAPHITE GREY

- 1 X 15W CREE LED
- 3000 Kelvin
- Lumen Output: 480lm
- LED driver included
- Electronic driver 120V 50/60Hz
- IP 54
- CRI: 80+
- High corrosion resistant die-cast aluminum body
- Stainless steel screws
- Silicone rubber gasket
- Powder coated with pretreatment for outdoor use
- Patented design
- Cover plate included for standard junction box



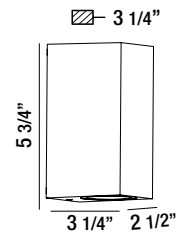

28290-018 MARINE GREY
28290-025 GRAPHITE GREY

- 2 X 7W CREE LED
- 3000 Kelvin
- Lumen Output: 870lm
- LED driver included
- Electronic driver 120V 50/60Hz
- IP 54
- CRI: 80+
- High corrosion resistant die-cast aluminum body
- Stainless steel screws
- Silicone rubber gasket
- Powder coated with pretreatment for outdoor use
- Patented design
- Cover plate included for standard junction box



up & down light

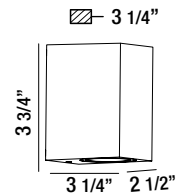

28291-015 MARINE GREY
28291-022 GRAPHITE GREY

- 1 X 7W CREE LED
- 3000 Kelvin
- Lumen Output: 470lm
- LED driver included
- Electronic driver 120V 50/60Hz
- IP 54
- CRI: 80+
- High corrosion resistant die-cast aluminum body
- Stainless steel screws
- Silicone rubber gasket
- Powder coated with pretreatment for outdoor use
- Patented design
- Cover plate included for standard junction box



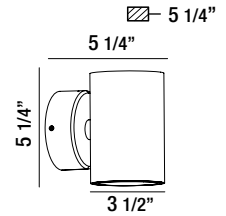

28295-013 MARINE GREY
28295-020 GRAPHITE GREY

- 2 X 7W CREE LED
- 3000 Kelvin
- Lumen Output: 820lm
- LED driver included
- Electronic driver 120V 50/60Hz
- IP 54
- CRI: 80+
- High corrosion resistant die-cast aluminum body
- Stainless steel screws
- Silicone rubber gasket
- Powder coated with pretreatment for outdoor use
- Patented design
- Cover plate included for standard junction box

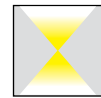

up & down light

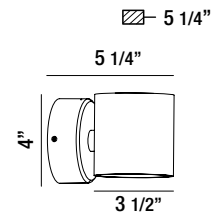

28292-012 MARINE GREY
28292-029 GRAPHITE GREY

- 1 X 7W CREE LED
- 3000 Kelvin
- Lumen Output: 500lm
- LED driver included
- Electronic driver 120V 50/60Hz
- IP 54
- CRI: 80+
- High corrosion resistant die-cast aluminum body
- Stainless steel screws
- Silicone rubber gasket
- Powder coated with pretreatment for outdoor use
- Patented design
- Cover plate included for standard junction box



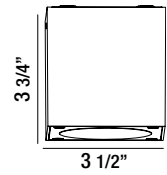

28286-011 MARINE GREY
28286-028 GRAPHITE GREY

- 1 X 7W CREE LED
- 3000 Kelvin
- Lumen Output: 380lm
- LED driver included
- Electronic driver 120V 50/60Hz
- IP 54
- CRI: 80+
- High corrosion resistant die-cast aluminum body
- Stainless steel screws
- Silicone rubber gasket
- Powder coated with pretreatment for outdoor use
- Patented design
- Cover plate included for standard junction box

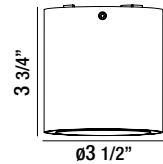

28287-018 MARINE GREY
28287-025 GRAPHITE GREY

- 1 X 7W CREE LED
- 3000 Kelvin
- Lumen Output: 380lm
- LED driver included
- Electronic driver 120V 50/60Hz
- IP 54
- CRI: 80+
- High corrosion resistant die-cast aluminum body
- Stainless steel screws
- Silicone rubber gasket
- Powder coated with pretreatment for outdoor use
- Patented design
- Cover plate included for standard junction box



— SURFACE MOUNT



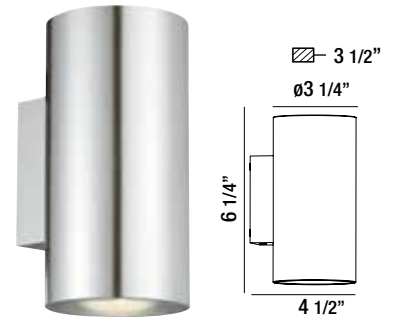

28301-011

- 2 X 7W CREE LED
- 3000 Kelvin
- Lumen Output: 680lm
- LED driver included
- Electronic driver 120V 50/60Hz
- IP 54
- CRI: 80+
- High corrosion resistant die-cast aluminum body
- Stainless steel screws
- Silicone rubber gasket
- Powder coated with pretreatment for outdoor use
- Patented design
- Cover plate included for standard junction box



up & down light

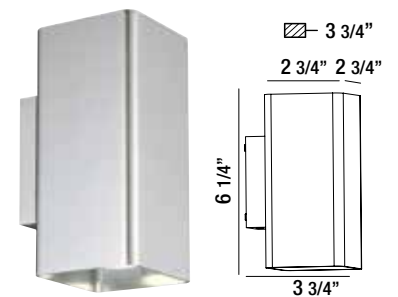

28302-018

- 2 X 7W CREE LED
- 3000 Kelvin
- Lumen Output: 680lm
- LED driver included
- Electronic driver 120V 50/60Hz
- IP 54
- CRI: 80+
- High corrosion resistant die-cast aluminum body
- Stainless steel screws
- Silicone rubber gasket
- Powder coated with pretreatment for outdoor use
- Patented design
- Cover plate included for standard junction box



up & down light



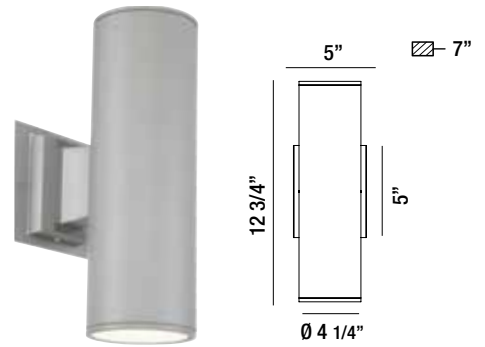

30349-018

- 2 X 10W CREE LED
- 3000 Kelvin
- Lumen Output: 1500lm
- LED driver included
- Electronic driver 120V 50/60Hz
- IP 54
- CRI: 80+
- High corrosion resistant die-cast aluminum body
- Stainless steel screws
- Silicone rubber gasket
- Powder coated with pretreatment for outdoor use
- Patented design
- Cover plate included for standard junction box

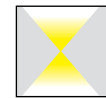

up & down light

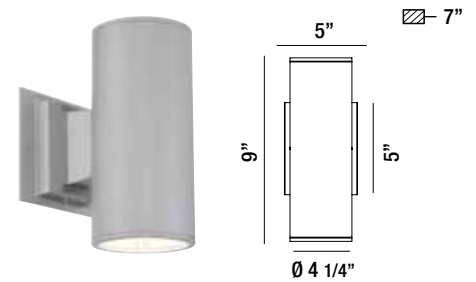

30347-014

- 1 X 10W CREE LED
- 3000 Kelvin
- Lumen Output: 750lm
- LED driver included
- Electronic driver 120V 50/60Hz
- IP 54
- CRI: 80+
- High corrosion resistant die-cast aluminum body
- Stainless steel screws
- Silicone rubber gasket
- Powder coated with pretreatment for outdoor use
- Patented design
- Cover plate included for standard junction box





6"

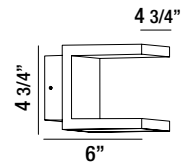

28284-017 MARINE GREY
28284-024 GRAPHITE GREY

- 120 X 0.1W CREE LED
- 3000 Kelvin
- Lumen Output: 490lm
- LED driver included
- Electronic driver 120V 50/60Hz
- IP 54
- CRI: 80+
- High corrosion resistant die-cast aluminum body
- Stainless steel screws
- Silicone rubber gasket
- Powder coated with pretreatment for outdoor use
- Patented design
- Cover plate included for standard junction box



4 3/4"

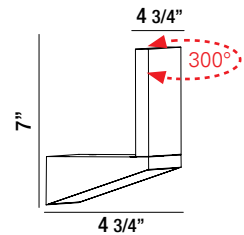

28283-010 MARINE GREY
28283-027 GRAPHITE GREY

- 60 X 0.1W CREE LED
- 3000 Kelvin
- Lumen Output: 220lm
- LED driver included
- Electronic driver 120V 50/60Hz
- IP 54
- CRI: 80+
- High corrosion resistant die-cast aluminum body
- Stainless steel screws
- Silicone rubber gasket
- Powder coated with pretreatment for outdoor use
- Patented design
- Cover plate included for standard junction box



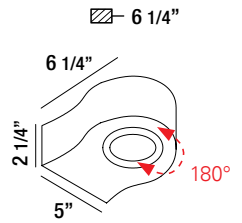

28276-012 MARINE GREY
28276-029 GRAPHITE GREY

- 1 X 7W CREE LED
- 3000 Kelvin
- Lumen Output: 300lm
- LED driver included
- Electronic driver 120V 50/60Hz
- IP 54
- CRI: 80+
- High corrosion resistant die-cast aluminum body
- Stainless steel screws
- Silicone rubber gasket
- Powder coated with pretreatment for outdoor use
- Patented design
- Cover plate included for standard junction box

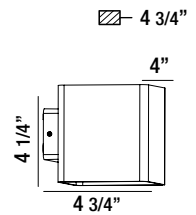

28285-014 MARINE GREY
28285-021 GRAPHITE GREY

- 2 X 5W CREE LED
- 3000 Kelvin
- Lumen Output: 620lm
- LED driver included
- Electronic driver 120V 50/60Hz
- IP 54
- CRI: 80+
- High corrosion resistant die-cast aluminum body
- Stainless steel screws
- Silicone rubber gasket
- Powder coated with pretreatment for outdoor use
- Patented design
- Cover plate included for standard junction box

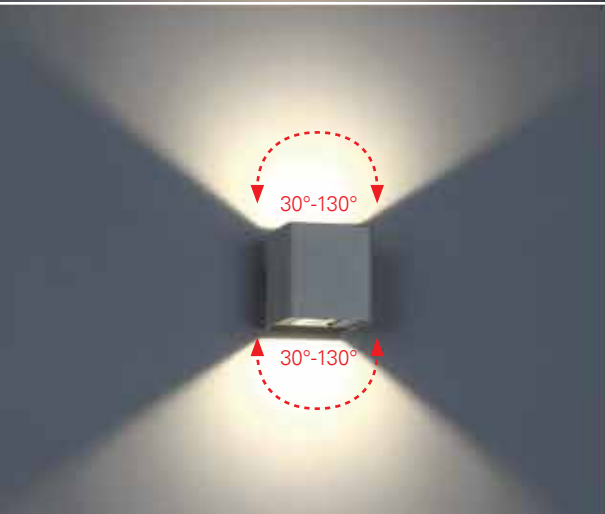

up & down light



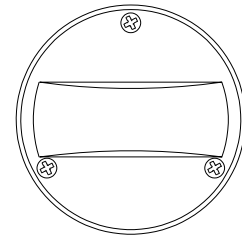

1 5/8"

Ø 3 7/8"

31954-013

- 4 x 1W LED
- 2700 Kelvin
- Lumen Output: 170lm
- Transformer not included
- IP 65
- CRI: 80+
- Solid brass body
- Textured bronze finish
- 3 feet of waterproof, copper core, PVC jacketed body, UV protected wire included



up & down light

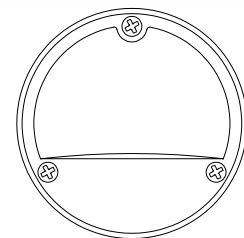

1 5/8"

Ø 3 7/8"

31953-016

- 1 x 3W LED
- 2700 Kelvin
- Lumen Output: 120lm
- Transformer not included
- IP 65
- CRI: 80+
- Solid brass body
- Textured bronze finish
- 3 feet of waterproof, copper core, PVC jacketed body, UV protected wire included





2 11/16"

2 11/16"

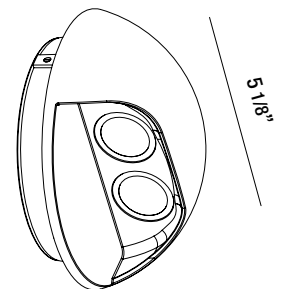

31583-015 MARINE GREY
31583-022 GRAPHITE GREY

- 2 X 3W CREE LED
- 3000 Kelvin
- Lumen Output: 260lm
- LED driver included
- Electronic driver 120V 50/60Hz
- IP 54
- CRI: 80+
- High corrosion resistant die-cast aluminum body
- Stainless steel screws
- Silicone rubber gasket
- Powder coated with pretreatment for outdoor use
- Patented design
- Cover plate included for standard junction box





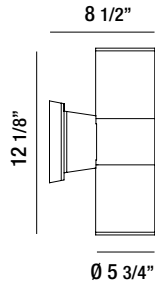

19204-017

- 2 x 75W max PAR30 120V
- IP 55
- Cylinder wall light for up and down lighting
- Exterior grade, cast aluminum construction with powder coated finish
- Completely enclosed unit with clear glass lens



up & down light

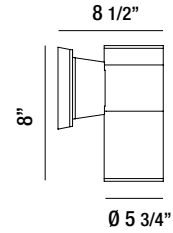

19202-013

- 1 x 75W max PAR30 120V
- IP 55
- Cylinder wall light for down lighting
- Exterior grade, cast aluminum construction with powder coated finish
- Completely enclosed unit with clear glass lens

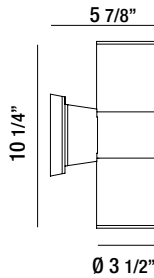

19205-014

- 2 x 50W max PAR20 120V
- IP 55
- Cylinder wall light for up and down lighting
- Exterior grade, cast aluminum construction with powder coated finish
- Completely enclosed unit with clear glass lens



up & down light

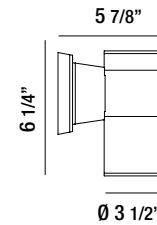

19206-011

- 1 x 50W max PAR20 120V
- IP 55
- Cylinder wall light for down lighting
- Exterior grade, cast aluminum construction with powder coated finish
- Completely enclosed unit with clear glass lens

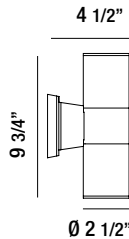

19203-010

- 2 x 50W max GU10 120V
- IP 55
- Cylinder wall light for up and down lighting
- Exterior grade, cast aluminum construction with powder coated finish
- Completely enclosed unit with clear glass lens



up & down light

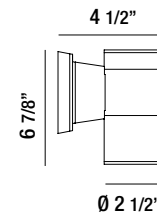

19201-016

- 1 x 50W max GU10 120V
- IP 55
- Cylinder wall light for down lighting
- Exterior grade, cast aluminum construction with powder coated finish
- Completely enclosed unit with clear glass lens





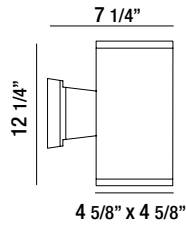

19210-018

- 2 x 75W max PAR30 120V
- IP 55
- Square wall light for up and down lighting
- Exterior grade, cast aluminum construction with powder coated finish
- Completely enclosed unit with clear glass lens



up & down light

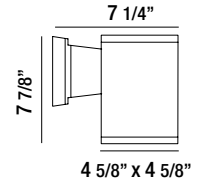

19208-015

- 1 x 75W max PAR30 120V
- IP 55
- Square wall light for down lighting
- Exterior grade, cast aluminum construction with powder coated finish
- Completely enclosed unit with clear glass lens

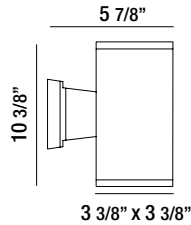

19209-012

- 2 x 50W max GU10 120V
- IP 55
- Square wall light for up and down lighting
- Exterior grade, cast aluminum construction with powder coated finish
- Completely enclosed unit with clear glass lens



up & down light

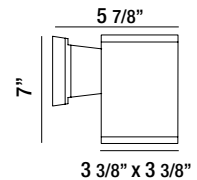

19207-018

- 1 x 50W max GU10 120V
- IP 55
- Square wall light for down lighting
- Exterior grade, cast aluminum construction with powder coated finish
- Completely enclosed unit with clear glass lens

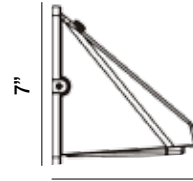

6 1/2"

26078-014

- 12W LED
- Lumen Output: 850lm
- 5000K
- CRI:72+
- 120V
- UL and CUL listed for wet locations
- IP 66, dust and water jet tight
- Corrosion resistant die-cast all aluminum construction
- Superior powder coated finish
- Corrosion resistant hardware
- High impact polycarbonate lens
- Weatherproof and durable silicone rubber gaskets keep water and insects out



5 7/8"

7 5/16"

26079-011

- 12W LED
- Lumen Output: 850lm
- 5000K
- CRI:72+
- 120V
- Unique design
- UL and CUL listed for wet locations
- IP 65, rated
- Corrosion resistant die-cast all aluminum construction
- Superior powder coated finish
- Heavy duty polycarbonate lens



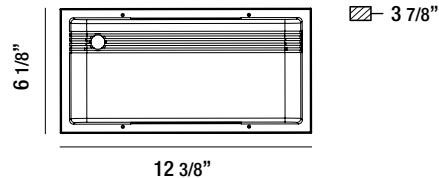

12 3/8"

23437-012

- 10W CREE LED
- Lumen Output: 600lm
- 4700K
- CRI: 80+
- 120V/277V
- Parking areas, entrances, walkways, underpasses, schools, garages and recreation areas
- UL listed / CUL listed for wet locations
- Heavy duty die-cast aluminum powder coated construction
- Heat and impact resistant tempered glass lens
- Dark architectural bronze color
- Powder coated finish
- Silicone rubber included to prevent any leakage from the outside
- One piece anodized aluminum designed reflector for best light efficiency

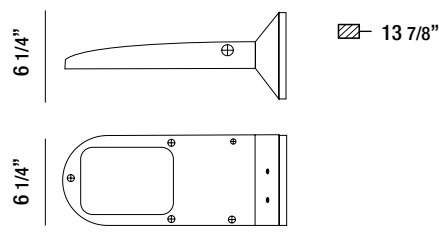

6 1/4"

13 7/8"

6 1/4"

13 7/8"

23250-017

- 10W CREE LED
- Lumen Output: 680lm
- 4700K
- CRI: 80+
- 120V/277V
- Die cast housing
- Architectural bronze UV resistant powder coated finish
- UL listed / CUL listed for wet locations
- Low Tj for long life, low lumen depreciation
- Lumen per LED - approx. 90~95
- Low starting temp -30°C
- IC current controlled LED circuits



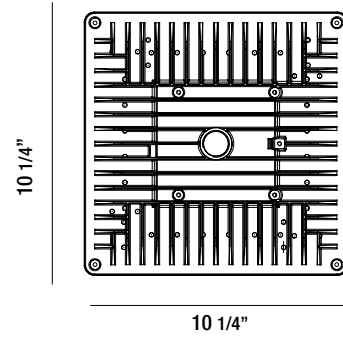

23251-014

- 20W CREE LED
- Lumen Output: 2560lm
- 4700K
- CRI: 80+
- Efficient general ceiling lighting
- Die cast housing
- Architectural bronze UV resistant powder coated finish
- UL listed / CUL listed for wet locations
- Low Tj for long life, low lumen depreciation



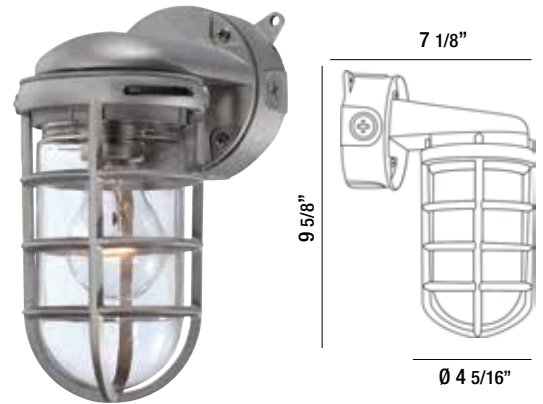

23264-014

- 1 x 100W/E26/120V (included)
- UL listed / CUL listed for wet locations
- Heavy duty die-cast aluminum with powder coated finish
- Clear heat resistant tempered glass lens
- High temperature silicone internal gaskets
- 1/2" tapped holes available for through branch circuit wiring
- UL listed porcelain medium base socket

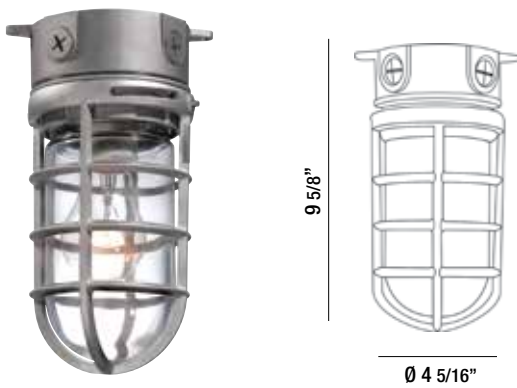

23265-011

- 1 x 100W/E26/120V (included)
- UL listed / CUL listed for wet locations
- Heavy duty die-cast aluminum with powder coated finish
- Clear heat resistant tempered glass lens
- High temperature silicone internal gaskets
- 1/2" tapped holes available for through branch circuit wiring
- UL listed porcelain medium base socket

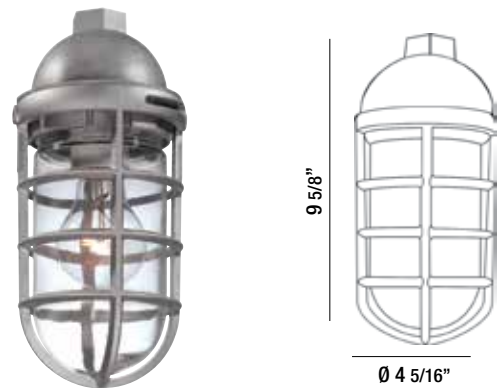

23266-018

- 1 x 100W/E26/120V (included)
- UL listed / CUL listed for wet locations
- Heavy duty die-cast aluminum with powder coated finish
- Clear heat resistant tempered glass lens
- High temperature silicone internal gaskets
- 1/2" tapped holes available for through branch circuit wiring
- UL listed porcelain medium base socket

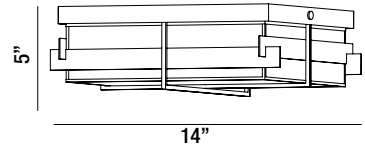

28055-013*
Oil Rubbed Bronze

2-LIGHT OUTDOOR FLUSHMOUNT
2 x 60W/E26/120V (included)

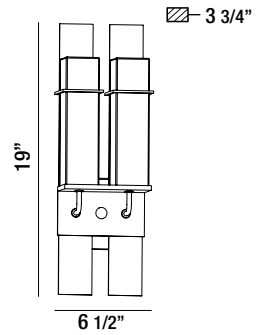

28054-016*
Oil Rubbed Bronze

2-LIGHT OUTDOOR WALL SCNCE
2 x 60W/E26/120V (included)

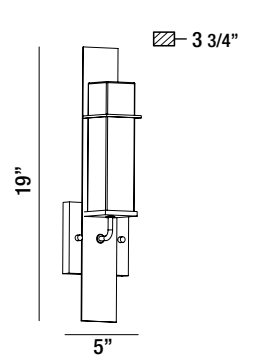

28053-019*
Oil Rubbed Bronze

1-LIGHT OUTDOOR WALL SCNCE
1 x 60W/E26/120V (included)

*** VINTAGE FILAMENT BULB INCLUDED**

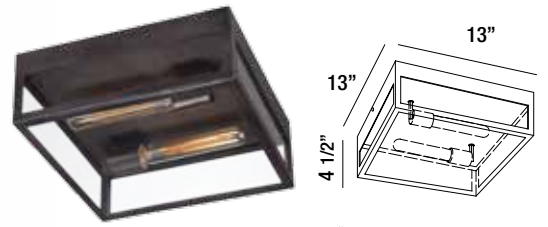

25604-016*
Bronze

2-LIGHT OUTDOOR FLUSHMOUNT
2 x 60W/E26/120V (included)

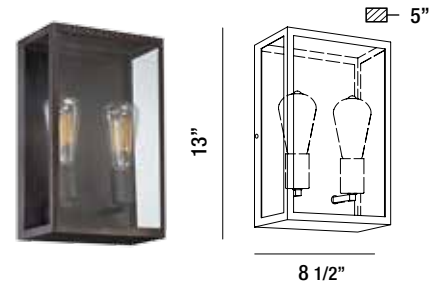

25603-019*
Bronze

2-LIGHT OUTDOOR WALL SCONCE
2 x 60W/E26/120V (included)

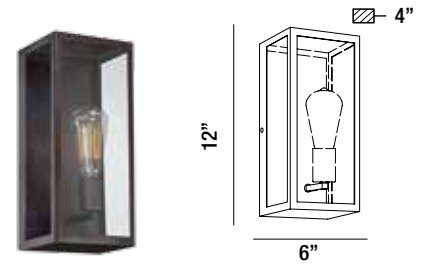

25602-012*
Bronze

1-LIGHT OUTDOOR WALL SCONCE
1 x 60W/E26/120V (included)

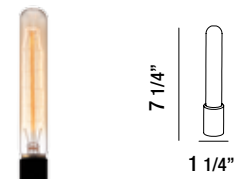

25843-019

VINTAGE FILAMENT BULB
1 x 60W/T10 E26/120V

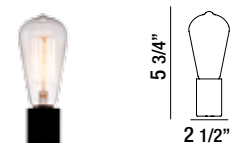

25842-012

VINTAGE FILAMENT BULB
1 x 60W/E26/120V

*** VINTAGE FILAMENT BULB INCLUDED**



IN-WALL

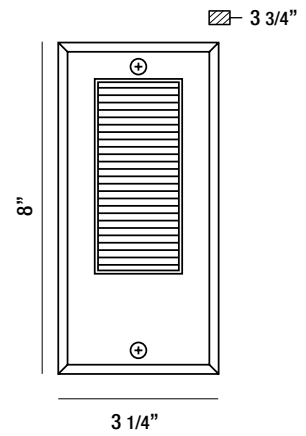

14751-011

- 1 X 0.4W CREE LED
- 3000 Kelvin
- Lumen Output: 420lm
- LED driver included
- Electronic driver 120V 50/60Hz
- IP 54
- CRI: 80+
- High corrosion resistant die-cast aluminum body
- Stainless steel screws
- Silicone rubber gasket
- Stainless steel face plate
- Patented design

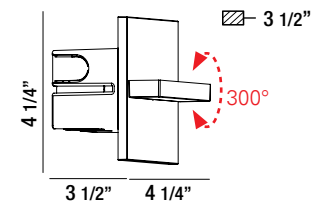

28294-016 MARINE GREY
28294-023 GRAPHITE GREY

- 1 X 3W CREE LED
- 3000 Kelvin
- Lumen Output: 90lm
- LED driver included
- Electronic driver 120V 50/60Hz
- IP 54
- CRI: 80+
- High corrosion resistant die-cast aluminum body
- Stainless steel screws
- Silicone rubber gasket
- Powder coated with pretreatment for outdoor use
- Patented design



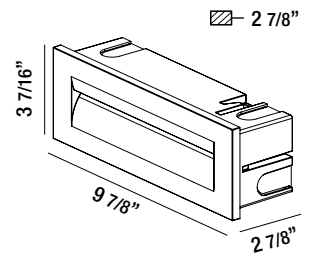

31576-017 MARINE GREY
31576-024 GRAPHITE GREY

- 8.5W CREE LED
- 3000 Kelvin
- Lumen Output: 190lm
- LED driver included
- Electronic driver 120V 50/60Hz
- IP 65
- CRI: 80+
- High corrosion resistant die-cast aluminum body
- Stainless steel screws
- Silicone rubber gasket
- Powder coated with pretreatment for outdoor use
- Patented design

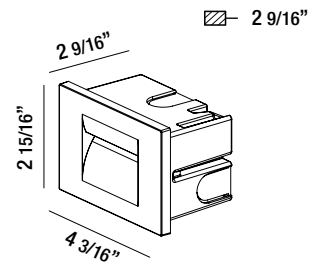
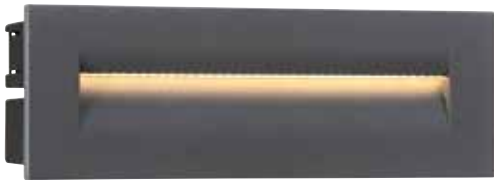

31590-013 MARINE GREY
31590-020 GRAPHITE GREY

- 3.6W CREE LED
- 3000 Kelvin
- Lumen Output: 80lm
- LED driver included
- Electronic driver 120V 50/60Hz
- IP 65
- CRI: 80+
- High corrosion resistant die-cast aluminum body
- Stainless steel screws
- Electronic driver 120V 50/60Hz
- Silicone rubber gasket
- Powder coated with pretreatment for outdoor use
- Patented design





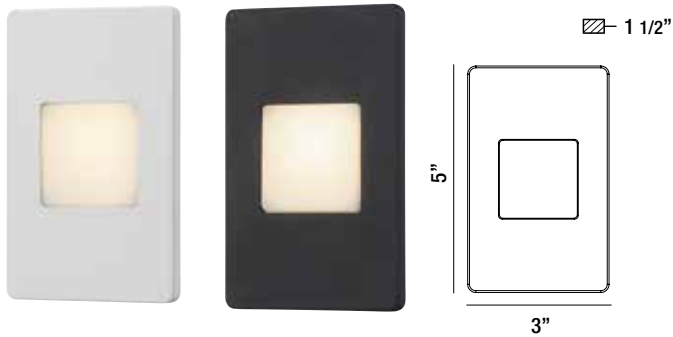

30286-016 WHITE
30286-023 BLACK

- 1 X 3W LED
- 3000 Kelvin
- Lumen Output: 120lm
- LED driver included
- Electronic driver 120V 50/60Hz
- IP 54
- CRI: 80+
- High corrosion resistant die-cast aluminum body
- Stainless steel screws
- Silicone rubber gasket
- Powder coated with pretreatment for outdoor use
- Mounts in standard 2" x 3" switch box

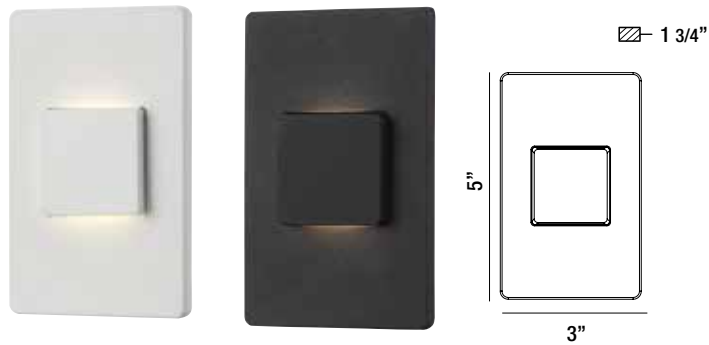

30287-013 WHITE
30287-020 BLACK

- 1 X 3W LED
- 3000 Kelvin
- Lumen Output: 120lm
- LED driver included
- Electronic driver 120V 50/60Hz
- IP 54
- CRI: 80+
- High corrosion resistant die-cast aluminum body
- Stainless steel screws
- Silicone rubber gasket
- Powder coated with pretreatment for outdoor use
- Mounts in standard 2" x 3" switch box

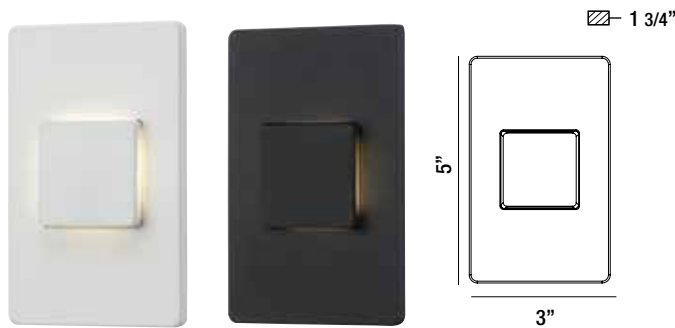

30288-010 WHITE
30288-027 BLACK

- 1 X 3W LED
- 3000 Kelvin
- Lumen Output: 120lm
- LED driver included
- Electronic driver 120V 50/60Hz
- IP 54
- CRI: 80+
- High corrosion resistant die-cast aluminum body
- Stainless steel screws
- Silicone rubber gasket
- Powder coated with pretreatment for outdoor use
- Mounts in standard 2" x 3" switch box



30289-017 WHITE
30289-024 BLACK

- 1 X 3W LED
- 3000 Kelvin
- Lumen Output: 120lm
- LED driver included
- Electronic driver 120V 50/60Hz
- IP 54
- CRI: 80+
- High corrosion resistant die-cast aluminum body
- Stainless steel screws
- Silicone rubber gasket
- Powder coated with pretreatment for outdoor use
- Mounts in standard 2" x 3" switch box



Horizontal Option



Vertical Option



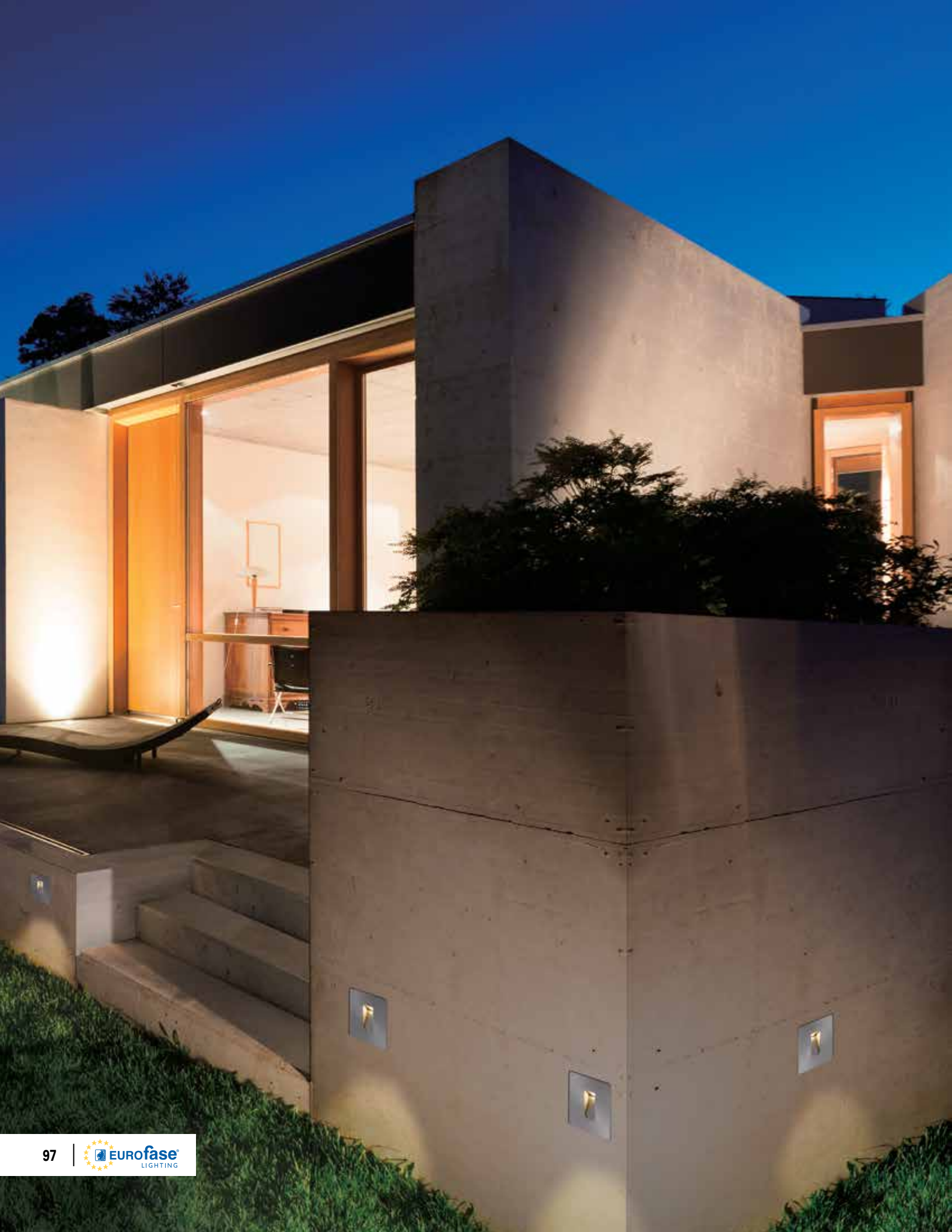



32148-015

- 1 X 3W CREE LED
- 3000 Kelvin
- Lumen Output: 60lm
- LED driver included
- Electronic driver 120V 50/60Hz
- IP 65
- CRI: 80+
- High corrosion resistant die-cast aluminum body
- Polyester painting with phosphochromating pre-finish
- Stainless steel ring AISI 304
- Clear tempered glass
- Silicone rubber gasket
- Polypropylene housing for recess included



32149-012

- 1 X 3W CREE LED
- 3000 Kelvin
- Lumen Output: 60lm
- LED driver included
- Electronic driver 120V 50/60Hz
- IP 65
- CRI: 80+
- High corrosion resistant die-cast aluminum body
- Polyester painting with phosphochromating pre-finish
- Stainless steel ring AISI 304
- Clear tempered glass
- Silicone rubber gasket
- Polypropylene housing for recess included



32150-018

- 1 X 3W CREE LED
- 3000 Kelvin
- Lumen Output: 60lm
- LED driver included
- Electronic driver 120V 50/60Hz
- IP 65
- CRI: 80+
- High corrosion resistant die-cast aluminum body
- Polyester painting with phosphochromating pre-finish
- Stainless steel ring AISI 304
- Clear tempered glass
- Silicone rubber gasket
- Polypropylene housing for recess included

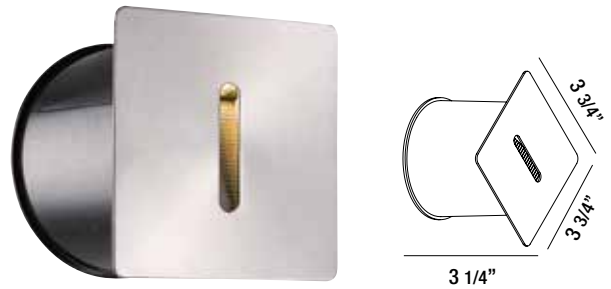

32151-015

- 1 X 3W CREE LED
- 3000 Kelvin
- Lumen Output: 60lm
- LED driver included
- Electronic driver 120V 50/60Hz
- IP 65
- CRI: 80+
- High corrosion resistant die-cast aluminum body
- Polyester painting with phosphochromating pre-finish
- Stainless steel ring AISI 304
- Clear tempered glass
- Silicone rubber gasket
- Polypropylene housing for recess included



MODEL #	PAGE #	MODEL #	PAGE #	MODEL #	PAGE #	MODEL #	PAGE #
14746-017	50	28281-016	61	31579-018	66	31951-012	18
14748-011	54	28281-023	61	31579-025	66	31952-019	18
14749-018	54	28282-013	61	31580-014	69	31953-016	81
14750-014	54	28282-020	61	31580-021	69	31954-013	81
14751-011	93	28283-010	79	31581-011	63	31955-010	34
14754-012	50	28283-027	79	31581-028	63	31956-017	34
14755-019	50	28284-017	79	31582-018	69	31957-014	34
19201-016	84	28284-024	79	31582-025	69	31958-011	34
19202-013	84	28285-014	80	31583-015	82	31959-018	22
19203-010	84	28285-021	80	31583-022	82	31960-014	22
19204-017	84	28286-011	76	31585-019	71	31961-011	35
19205-014	84	28286-028	76	31585-026	71	31962-018	35
19206-011	84	28287-018	76	31586-016	72	31963-015	35
19207-018	86	28287-025	76	31586-023	72	31964-012	35
19208-015	86	28288-015	64	31587-013	72	31965-019	35
19209-012	86	28288-022	64	31587-020	72	31966-016	35
19210-018	86	28289-012	67	31589-017	62	31967-013	35
19552-019	50	28289-029	67	31589-024	62	31968-010	35
22518-019	40	28290-018	74	31590-013	94	31969-017	36
22520-012	40	28290-025	74	31590-020	94	31970-013	36
22521-019	40	28291-015	74	31595-018	48	31973-014	17
22523-013	40	28291-022	74	31596-015	48	31974-011	19
22534-019	56	28292-012	75	31909-027	7	31975-018	24
23250-017	88	28292-029	75	31911-023	8	31976-015	35
23251-014	89	28293-019	64	31912-020	2	32093-018	57
23264-014	90	28293-026	64	31913-027	11	32094-015	57
23265-011	90	28294-016	93	31914-024	12	32095-012	58
23266-018	90	28294-023	93	31915-021	3	32096-019	58
23437-012	88	28295-013	75	31916-028	4	32097-016	52
23815-018	41	28295-020	75	31918-022	9	32098-013	52
23816-015	41	28296-010	68	31919-029	14	32099-010	52
23817-012	42	28296-027	68	31920-025	14	32100-013	52
24424-011	56	28297-017	68	31921-022	14	32148-015	98
25602-012	92	28297-024	68	31922-029	6	32149-012	98
25603-019	92	28301-011	77	31923-026	6	32150-018	98
25604-016	92	28302-018	77	31926-010	18	32151-015	98
25842-012	92	30286-016	96	31930-017	20	32188-011	44
25843-019	92	30286-023	96	31931-014	27	32189-018	46
26078-014	87	30287-013	96	31932-011	25	32190-014	46
26079-011	87	30287-020	96	31933-018	25	32191-011	46
28053-019	91	30288-010	96	31934-015	26	32192-018	46
28054-016	91	30288-027	96	31935-012	26	32193-015	48
28055-013	91	30289-017	96	31936-019	27	32194-012	48
28274-018	70	30289-024	96	31937-016	28	32356-014	36
28274-025	70	30347-014	78	31938-013	28	32357-011	36
28275-015	67	30349-018	78	31939-010	29	32358-018	36
28275-022	67	31435-017	60	31940-016	29	32359-015	36
28276-012	80	31436-014	60	31941-013	24	32379-16-100	35
28276-029	80	31437-011	60	31942-010	24	32379-16-250	35
28277-019	73	31574-013	63	31943-017	30	32379-16-500	35
28277-026	73	31574-020	63	31944-014	30	32398-14-100	35
28278-016	73	31576-017	94	31945-011	32	32398-14-250	35
28278-023	73	31576-024	94	31946-018	32	32398-14-500	35
28279-013	70	31577-014	62	31947-015	10	32399-12-100	35
28279-020	70	31577-021	62	31948-012	10	32399-12-250	35
28280-019	65	31578-011	66	31949-019	17	32399-12-500	35
28280-026	65	31578-028	66	31950-015	17	IG-01-S5	42
						IG-02-S5	42



Eurofase Inc.
33 West Beaver Creek Road
Richmond Hill, Ontario
Canada L4B 1L8

tel 905.695.2055 toll free 1.800.660.5391
fax 905.695.2056 toll free 1.800.660.5390

Dallas Trade Mart
Eurofase Showroom, Suite #4002

www.eurofase.com

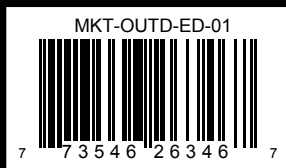

Printed in Canada
© 2017 Eurofase Inc. All rights reserved.
Product Specifications and Approvals

Eurofase Inc. reserves the right to make alterations to the construction and design of products shown in this catalog in order to meet the laws or regulations of any authorized governing organization. The use of products shown in this catalog must comply with local building codes.

