



by Schneider Electric

Installation and Operation Smart-UPS™ SUA500PDR

Important Safety Instructions

SAVE THESE INSTRUCTIONS - This manual contains important instructions that should be followed during installation and maintenance of the Smart-UPS and batteries.

Read these instructions carefully and look at the equipment to become familiar with the device before trying to install, operate, service or maintain it. The following special messages may appear throughout this bulletin or on the equipment to warn of potential hazards or to call attention to information that clarifies or simplifies a procedure.



The addition of this symbol either to a “Danger” or “Warning” safety label indicates that an electrical hazard exists which will result in personal injury if the instructions are not followed.



This is the safety alert symbol. It is used to alert you to potential personal injury hazards. Obey all safety messages that follow this symbol to avoid possible injury or death.

DANGER

DANGER indicates a hazardous situation which, if not avoided, **will result in** death or serious injury.

WARNING

WARNING indicates a hazardous situation which, if not avoided, **could result in** death or serious injury.

CAUTION

CAUTION indicates a hazardous situation which, if not avoided, **could result in** minor or moderate injury.

NOTICE

NOTICE is used to address practices not related to physical injury.

Safety and General Information

- Adhere to all national and local electrical codes.
- All wiring must be performed by a qualified electrician.
- Changes and modifications to this unit not expressly approved by APC by Schneider Electric could void the warranty.
- This UPS is intended for indoor use only.
- Do not operate this UPS in direct sunlight, in contact with fluids, or where there is excessive dust or humidity.
- Do not operate the UPS near open windows or doors.
- Be sure the air vents on the UPS are not blocked. Allow adequate space for proper ventilation.
Note: Allow 20 cm clearance on all sides of the UPS.
- For a UPS with a factory installed power cord, connect the UPS power cable directly to a wall outlet. Do not use surge protectors or extension cords.
- The battery typically lasts for two to three years. environmental factors impact battery life. Elevated ambient temperatures, poor quality AC power, and frequent short duration discharges will shorten battery life.
- The UPS input ground conductor must be properly bonded to protective earth at the service panel. If the UPS input power is supplied by a separately derived system, the ground conductor must be properly bonded at the supply transformer or motor generator set.

Additional safety information can be found in the Safety Guide supplied with this unit.

Battery safety

CAUTION

RISK OF HYDROGEN SULPHIDE GAS AND EXCESSIVE SMOKE

- Replace the battery at least every 5 years or at the end of its service life, whichever is earlier.
- Replace the battery immediately when the UPS indicates battery replacement is necessary.
- Replace batteries with the same number and type of batteries as originally installed in the equipment.
- Replace the battery immediately when the UPS indicates a battery overtemperature condition, or when there is evidence of electrolyte leakage. Power off the UPS, unplug it from the AC input, and disconnect the batteries. Do not operate the UPS until the batteries have been replaced.
- *Replace all battery modules (including the modules in External Battery Packs) which are older than one year, when installing additional battery packs or replacing the battery module(s).

Failure to follow these instructions could result in equipment damage and minor or moderate injury.

*Contact APC by Schneider Electric Worldwide Customer Support to determine the age of the installed battery modules.

- Batteries typically last for two to three years. Environmental factors impact battery life. Elevated ambient temperatures, poor quality utility power, and frequent short duration discharges will shorten battery life. Batteries should be replaced before end of life.
- Schneider Electric uses Maintenance-Free sealed Lead Acid batteries. Under normal use and handling, there is no contact with the internal components of the battery. Over charging, over heating or other misuse of batteries can result in a discharge of battery electrolyte. Released electrolyte is toxic and may be harmful to the skin and eyes.
- CAUTION: Before installing or replacing batteries, remove jewelry such as wristwatches and rings. High energy through conductive materials could cause severe burns.
- Servicing of batteries should be performed or supervised by personnel knowledgeable of batteries and the required precautions. Keep unauthorized personnel away from batteries.
- CAUTION – Failed batteries can reach temperatures that exceed the burn thresholds for touchable surfaces.
- CAUTION – A battery can present a risk of electrical shock and high short circuit current. The following precautions should be observed when working on batteries:
 - Disconnect the charging source prior to connecting or disconnecting battery terminals.
 - Do not wear any metal objects including watches and rings.
 - Do not lay tools or metal parts on top of batteries.
 - Use tools with insulated handles.
 - Wear rubber gloves and boots.
 - Determine if battery is either intentionally or inadvertently grounded. Contact with any part of a grounded battery can result in electric shock and burns by high short-circuit current. The risk of

Radio frequency warning

such hazards can be reduced if grounds are removed during installation and maintenance by a skilled person.

- CAUTION: Do not dispose of batteries in a fire. The batteries may explode.
- CAUTION: Do not open or mutilate batteries. Released electrolyte is harmful to the skin and eyes and may be toxic.

Radio frequency warning

WARNING: This is a category C2 UPS product. In a residential environment, this product may cause radio interference, in which case the user may be required to take additional measures.

NOTE: This equipment has been tested and found to comply with the limits for a Class A digital device, pursuant to part 15 of the FCC Rules. These limits are designed to provide reasonable protection against harmful interference when the equipment is operated in a commercial environment. This equipment generates, uses, and can radiate radio frequency energy and, if not installed and used in accordance with the instruction manual, may cause harmful interference to radio communications. Operation of this equipment in a residential area is likely to cause harmful interference in which case the users will be required to correct the interference at their own expense.

Mount the UPS on DIN Rail

This unit is designed to mount on a heavy duty DIN rail or on the back panel of an enclosure. For details on DIN rail installation refer to the DIN rail installation guide included in the DIN rail package. The DIN rail kit is not included.

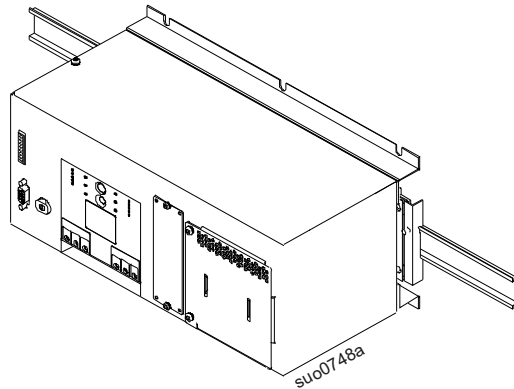

When mounting on the back panel of an enclosure, select screws that are appropriate for the weight of this unit and the mounting surface material.

Six screws must be used when mounting this unit in an enclosure. Three screws in the top of the bracket and three screws in the bottom of the bracket. Failure to follow these instructions may result in damage to the unit.

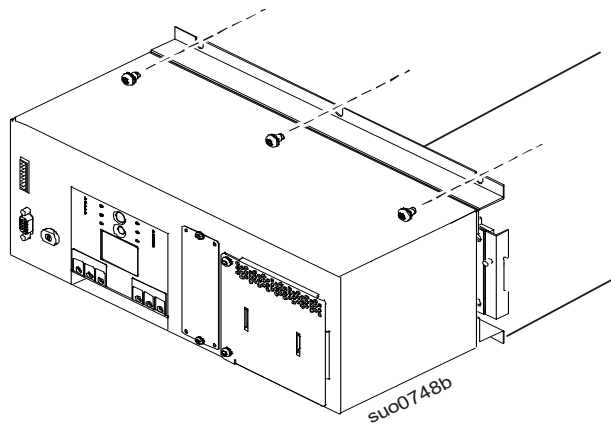

Battery Installation

The UPS battery is shipped in a separate carton.

Refer to the installation guide included with the replacement battery for installation instructions.

Front Panel

120 V model depicted.

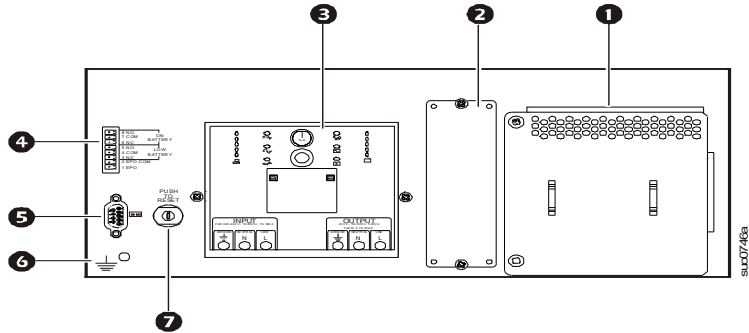

Connect Power and Equipment to the UPS

Hardwiring should be performed by a qualified electrician. Use appropriate size wires.

1. The UPS features a transient voltage surge-suppression (TVSS) screw located on the front panel. The TVSS screw is used for connecting the ground lead on surge suppression devices such as telephone and network line protectors.

Prior to connecting the grounding cable, ensure that the UPS is NOT connected to AC or battery power.

2. Hardwire the UPS.

- In 230 V applications the UPS must be protected with a circuit breaker that complies with European standards for branch rated protection per the country of installation.
- In 208 V applications, the SUA500PDRI must be protected by a dual pole, 10 A branch rated circuit breaker with UL489 rating.
- The 120 V SUA500PDR has supplementary circuit breaker protection. The unit should be protected by a single pole, 15 A branch rated circuit breaker with a UL489 rating. **Ensure that the branch circuit breaker is off prior to wiring the unit.**

120 V models

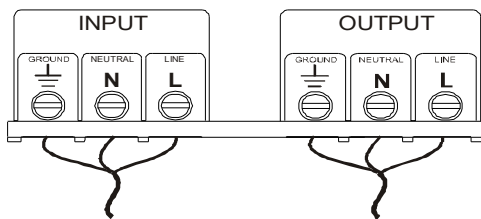

208/230 V

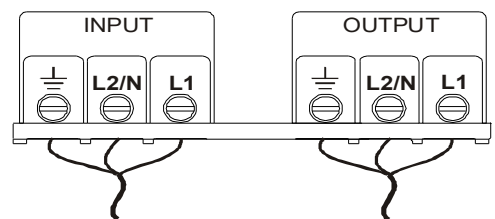

3. Connect equipment to the UPS.
4. Add optional accessories to the SmartSlot located on the front panel.
5. Turn on all connected equipment. To use the UPS as a master on/off switch, be sure all connected equipment is switched on.
6. Press the **Test** button on the front panel to start the UPS.
 - The battery charges to 90% capacity during the first four hours of normal operation.
 - *Do not* expect full battery run capability during this initial charge period.
7. For optimal computer system security, install PowerChute™ monitoring software included with the UPS.

Connectors

Communication Port

SERIAL PORT



A standard serial interface cable is incompatible with the UPS. Use the cable supplied with the unit.

Contact Closure Port

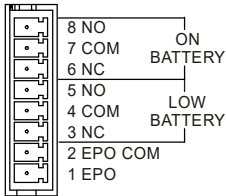

The relays are connected from the common (COM) to the normally closed (NC) pins. When the unit enters a low battery or on battery state, the appropriate relay will transition and connect the common (COM) to the normally open (NO) pin.

The Contact Closure Port connection will automatically disable when a Network Management Card or the Serial Port connection are used.

Output Contact Ratings:

Parameter	Value
nominal switching capacity	1 A @ 30 VDC
maximum switching power	30 W
maximum switching voltage	60 VDC
maximum switching current	2 ADC
maximum carrying current	2 ADC
surge ratings	2 kV per Bellcore TA-NWT-001089 1.5 kV per FCC part 68

Emergency Power Off

The emergency power off (EPO) feature is user configurable. EPO provides immediate de-energizing of connected equipment from a remote location, without switching to battery operation.

Use a normally-open contact to connect the EPO COM terminal to the EPO terminal.

The EPO interface is a Safety Extra Low Voltage (SELV) circuit. Connect it only to other SELV circuits. The EPO interface monitors circuits that have no determined voltage potential. Such closure circuits may be provided by a switch or relay properly isolated from the AC power source. To avoid damage to the UPS, do not connect the EPO interface to any circuit other than a closure type circuit.

Use one of the following cable types to connect the UPS to the EPO switch.

- CL2: Class 2 cable for general use.
- CL2P: Plenum cable for use in ducts, plenums, and other spaces used for environmental air.
- CL2R: Riser cable for use in a vertical run in a floor-to-floor shaft.
- CLEX: Limited use cable for use in dwellings and for use in raceways.
- For installation in Canada: Use only CSA certified, type ELC (extra-low voltage control cable).
- For installation in other countries: Use standard low-voltage cable in accordance with national and local regulations.

Operation

UPS Display Panel

120 V
models

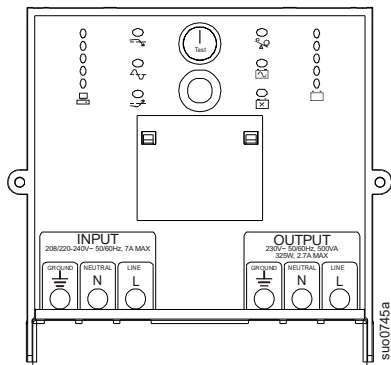



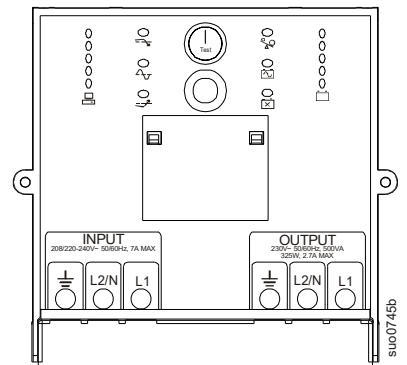



208/230 V
models







Display Panel Indicators and Function Buttons

Indicator LED	Indicator Title	Description
	On-Line	The UPS is supplying AC power to the connected equipment (see <i>Troubleshooting</i>).

Indicator LED	Indicator Title	Description
	AVR Trim	The UPS is compensating for a high AC voltage (see <i>Troubleshooting</i>).
	AVR Boost	The UPS is compensating for a low AC voltage (see <i>Troubleshooting</i>).
	On Battery	The UPS is supplying battery power to the connected equipment.
	Overload	The connected equipment is drawing more than the UPS power rating allows (see <i>Troubleshooting</i>).
	Replace Battery/Battery Disconnected	The battery is disconnected or must be replaced (see <i>Troubleshooting</i>).

<p>120V 230V</p> <p>○ 133 ○ 266</p> <p>○ 123 ○ 248</p> <p>○ 114 ○ 229</p> <p>○ 105 ○ 210</p> <p>○ 96 ○ 191</p> <p>Battery Charge </p>	<p>Diagnostic Utility Voltage</p>	<p>The UPS has a diagnostic feature that indicates the AC voltage. The UPS starts a self-test as part of this procedure. The self-test does not affect the voltage display.</p> <p>Press and hold the Test button to view the AC voltage bar graph indicator. After a few seconds, this five-LED <i>Battery Charge</i> indicator on the right of the display panel will show the AC input voltage.</p> <p>Refer to the figure on the left for the voltage reading (values are not listed on the UPS).</p> <p>The indicator on the UPS shows the voltage is between the displayed value on the list and the next higher value (see <i>Troubleshooting</i>).</p>
--	-----------------------------------	---

Feature Button	Feature Title	Function
	Power On	Press this button to turn on the UPS. Continue reading for additional capabilities.
	Power Off	Press this button to turn off the UPS.
	Self-Test	<p>Automatic: The UPS performs a self-test automatically when turned on, and every two weeks thereafter (by default). During the self-test, the UPS briefly operates the connected equipment on battery.</p> <p>Manual: Press and hold the Test button for a few seconds to initiate the self-test.</p>
	Cold Start	When there is no AC power and the UPS is off, the cold start feature will switch the UPS and connected equipment onto battery power (see <i>Troubleshooting</i>).

User Configurable Items

UPS settings

Settings are adjusted through PowerChute™ software or optional Network Management Card.

Function	Factory Default	User Selectable Choices	Description
Automatic Self-Test	Every 14 days (336 hours)	<ul style="list-style-type: none"> • Every 7 days (168 hours) • On start up only • No self-test 	Set the interval at which the UPS will execute a self-test.
UPS ID	UPS_IDEN	Up to eight characters (alphanumeric)	Uniquely identify the UPS (i.e. server name or location) for network management purposes.
Date of Last Battery Replacement	Manufacture Date	mm/dd/yy	Reset this date when you replace the battery module.
Minimum Capacity Before Return from Shutdown	0 percent	<ul style="list-style-type: none"> <li style="width: 50%;">• 0% <li style="width: 50%;">• 60% <li style="width: 50%;">• 15% <li style="width: 50%;">• 75% <li style="width: 50%;">• 30% <li style="width: 50%;">• 90% <li style="width: 50%;">• 45% 	Specify the percentage to which batteries will be charged following a low battery shutdown before powering connected equipment.
Voltage Sensitivity	High sensitivity	High sensitivity Medium sensitivity Low sensitivity	The UPS detects and reacts to line voltage distortions by transferring to battery operation to help protect the connected equipment. In situations of poor power quality, the UPS may frequently transfer to battery operation. If the connected equipment can operate normally under such conditions, reduce the sensitivity setting to conserve battery capacity and service life.
Alarm Delay Control	Enable	<ul style="list-style-type: none"> • Enable • Mute • Disable 	Mute ongoing alarms or disable all alarms permanently.
Shutdown Delay	90 seconds	<ul style="list-style-type: none"> <li style="width: 50%;">• 0 s <li style="width: 50%;">• 360 s <li style="width: 50%;">• 90 s <li style="width: 50%;">• 450 s <li style="width: 50%;">• 180 s <li style="width: 50%;">• 540 s <li style="width: 50%;">• 270 s <li style="width: 50%;">• 630 s 	Set the interval between the time when the UPS receives a shutdown command and actual shutdown.

Function	Factory Default	User Selectable Choices	Description
Low Battery Alarm	2 minutes	2, 5, 8, 11, 14, 17, 20, 23 minutes	<p>PowerChute™ software interface provides automatic, unattended shutdown when approximately two minutes of battery operated run time remains.</p> <p>The low-battery audible alarm beeps are continuous when two minutes of run time remain.</p> <p>Change the low battery alarm interval setting to the time that the operating system or system software requires to shut down.</p>
Synchronized Turn-on Delay	0 seconds	<ul style="list-style-type: none"> • 0 s • 60 s • 120 s • 180 s • 240 s • 300 s • 360 s • 420 s 	Specify the time the UPS will wait after the return of AC power before start up (to avoid branch circuit overload).
High Transfer Point	<p><i>120 V models:</i> 127 VAC</p> <p><i>230 V models:</i> 253 VAC</p>	<ul style="list-style-type: none"> • 127 VAC • 130 VAC • 253 VAC • 257 VAC • 133 VAC • 136 VAC • 261 VAC • 265 VAC 	To avoid unnecessary use of the battery where AC voltage is chronically high, set the high transfer point higher if the connected equipment can tolerate this condition.
Low Transfer Point	<p><i>120 V models:</i> 106 VAC</p> <p><i>230 V models:</i> 208 VAC</p>	<ul style="list-style-type: none"> • 97 VAC • 100 VAC • 196 VAC • 200 VAC • 103 VAC • 106 VAC • 204 VAC • 208 VAC 	<p>To avoid unnecessary use of the battery where AC voltage is chronically low, set the low transfer point lower if the connected equipment can tolerate this condition.</p> <p>The SUA500PDRI ships ready for 230 V sources. When operating the UPS in 208 V applications, the UPS low transfer voltage settings are adjusted through PowerChute™ software or the Network Management Card. The proper setting for low transfer voltage is 196 V.</p> <p>Refer to the PowerChute™ user guide or the Network Management Card instructions for setting adjustment details.</p>
Output Voltage 230 V models	230 VAC	<ul style="list-style-type: none"> • 220 VAC • 230 VAC • 240 VAC 	<i>230 V models only:</i> Sets the output voltage of the UPS while operating on battery.

Specifications

Temperature	Operating	0 to 40 °C (32 to 104 °F)
	Storage	-15 to 45 °C (5 to 113 °F)
Max Elevation	Operating	2000 m (6562 ft)
	Storage	15240 m (50000 ft)
Humidity	0 to 95% relative humidity, non-condensing	
International Protection Code	IP20	
Pollution Degree	2	
Overvoltage Category	II	
Applicable Power Grid Power Distribution System	TN Power System	
Applicable Standard	IEC 62040-1	

Storage, Maintenance, Transport

Storage

Store the UPS covered in a cool, dry location with the batteries fully charged.

At 5° to 86° F (-15° to 30° C), charge the UPS battery every six months.

At 86° to 113° F (30° to 45° C), charge the UPS battery every three months.

Replacing the Battery Module

This UPS uses a replaceable, swappable battery module, isolated from electrical hazards. You may leave the UPS and connected equipment on during the replacement procedure.

Ensure battery replacement every 2-4 years.

APCRBC135: Standard (40° C) battery

APCRBC136: High Temperature (50° C) battery

Once the batteries are disconnected the connected equipment is not protected from power outages.

Refer to the appropriate replacement battery installation guide for battery module installation instructions. See your dealer for information on replacement battery modules.



Be sure to deliver the spent battery(s) to a recycling facility or ship it to the address specified in the replacement battery literature.

Troubleshooting

Use this chart to solve minor installation and operation problems.

Problem and/or Possible Cause	Solution
UPS will not turn on	
The battery is not connected properly.	Check that the battery connector is fully engaged.
 button not pushed.	Press the Test button once to power-up the UPS and connected equipment.
The UPS is not connected to AC power supply.	Check that the UPS is properly connected to AC power.
UPS will not turn off	
The UPS has detected an internal fault	Do not attempt to use the UPS. Unplug the UPS and have it serviced immediately.
UPS beeps occasionally	
Normal UPS operation when running on battery.	None: The UPS is helping protect the connected equipment. Press the Test button to silence this alarm.
UPS is not providing expected backup time	
The UPS battery(s) are weak due to a recent power outage or battery(s) are near the end of their service life.	Charge the battery(s). Batteries require recharging after extended outages. Batteries can wear faster when put into service often or when operated at elevated temperatures. If the battery(s) are near the end of their service life, consider replacing the battery(s) even if the <i>replace battery</i> LED is not yet illuminated.
Left half, Right half, or Center section of front panel is flashing	
The UPS has detected an internal fault.	Do not attempt to use the UPS. Unplug the UPS and have it serviced immediately.
All LEDs are illuminated and the UPS emits a constant beeping	
The UPS has detected an internal fault.	Do not attempt to use the UPS. Unplug the UPS and have it serviced immediately.
Front panel LEDs flash sequentially	
The UPS has been shut down remotely through software or an optional accessory card.	None: The UPS will restart automatically when AC power returns.
All LEDs are off and the UPS is wired to input AC power	
The UPS is shut down or the battery is discharged from an extended outage.	None: The UPS will restart automatically when AC power is restored and the battery has a sufficient charge.
The Overload LED is illuminated and the UPS emits a sustained alarm tone	
The UPS is overloaded.	<p>The connected equipment exceeds the specified “maximum load” as defined in <i>Specifications</i> listed on the rating label located on the UPS.</p> <p>The alarm remains on until the overload is removed. Disconnect nonessential equipment from the UPS to eliminate the overload condition.</p> <p>The UPS continues to supply power as long as it is online and the circuit breaker does not trip; the UPS will not provide power from batteries in the event of a AC voltage interruption.</p>

Problem and/or Possible Cause	Solution
The Replace Battery/Battery Disconnected LED is illuminated	
The <i>Replace Battery/Battery Disconnected</i> LED flashes and a short beep is emitted every two seconds to indicate the battery is disconnected.	Check that the battery connectors are fully engaged.
Weak battery	Allow the battery to recharge for 24 hours and perform a self-test. If the problem persists after recharging, replace the battery.
Battery has not passed the self-test: <i>Replace Battery/Battery Disconnected</i> LED illuminates and the UPS emits short beeps for one minute. The UPS repeats the alarm every five hours.	Allow the battery to recharge for 24 hours. Perform the self-test procedure to confirm the replace battery condition. The alarm stops and the LED clears if the battery passes the self-test. If the battery does not pass the self-test again, it must be replaced. The connected equipment is unaffected.
The input circuit breaker trips	
The connected equipment exceeds the specified “maximum load” as defined in <i>Specifications</i> listed on the rating label located on the UPS.	Unplug all nonessential equipment from the UPS. Reset the circuit breaker.
The AVR Boost or AVR Trim LEDs are illuminated	
The system is experiencing very high or low AC voltage.	Have a qualified service personnel check your facility for electrical problems. If the problem persists, contact the AC company for further assistance.
There is no AC power	
There is no AC power and the UPS is off	Use the cold start feature to supply power to the connected equipment from the UPS battery(s). Press and hold the Test button. The unit will emit two beeps, one short beep and one long beep. Release the button during the second beep.
UPS operates on battery although line voltage exists	
The UPS input circuit breaker trips.	Unplug all nonessential equipment from the UPS. Reset the circuit breaker.
Your system is experiencing very high, low or distorted line voltage.	Move the UPS to a different outlet on a different circuit: Inexpensive fuel powered generators may distort the voltage. Test the input voltage with the AC voltage display, (see <i>Operation</i>). If acceptable to the connected equipment, reduce the UPS sensitivity.
Battery Charge and Load LEDs flash simultaneously	
The UPS has shut down The internal temperature of the UPS has exceeded the allowable threshold for operation.	Check that the room temperature is within the specified limits for operation. Check that the UPS is properly installed, allowing for adequate ventilation. Allow the UPS to cool down. Restart the UPS.
Diagnostic AC voltage	
All five LEDs are illuminated.	The line voltage is extremely high and should be checked by an electrician.
There is no LED illumination.	If the UPS is plugged into a properly functioning AC power outlet, the line voltage is extremely low and should be checked by an electrician.
On-Line LED	
There is no LED illumination.	The UPS is running on battery, or it must be turned on.
The LED is blinking.	The UPS is running an internal self-test.
Software/Network integration problems	
Network Management Card difficulties.	Refer to the Network Management Card user guide on the CD shipped with the Network Management Card.

Problem and/or Possible Cause	Solution
Communication problems between the UPS and PowerChute™ software.	Ensure the correct communication cable (940-1524D) is being used. Refer to the PowerChute™ user manual on the CD shipped with the software.

Service

If the unit requires service, do not return it to the dealer. Follow these steps:

1. Review the *Troubleshooting* section of the manual to eliminate common problems.
2. If the problem persists, contact APC by Schneider Electric Customer Support through the APC Web site, **www.apc.com**.
 - a. Note the model number and serial number and the date of purchase. The model and serial numbers are located on the rear panel of the unit and are available through the LCD display on select models.
 - b. Call APC by Schneider Electric Customer Support and a technician will attempt to solve the problem over the phone. If this is not possible, the technician will issue a Returned Material Authorization Number (RMA#).
 - c. If the unit is under warranty, the repairs are free.
 - d. Service procedures and returns may vary internationally. Refer to the APC Web site for country specific instructions.
3. Pack the unit properly to avoid damage in transit. Never use foam beads for packaging. Damage sustained in transit is not covered under warranty.
 - a. **Always DISCONNECT THE UPS BATTERY before shipping in compliance with U.S. Department of Transportation (DOT) and IATA regulations.** The battery may remain in the unit.
 - b. Internal batteries may remain connected in the XLBP during shipment, if applicable, not all units have XLBPs.
4. Write the RMA# provided by Customer Support on the outside of the package.
5. Return the unit by insured, pre-paid carrier to the address provided by Customer Support.

Transport the unit

1. Shut down and disconnect all connected equipment.
2. Disconnect the unit from AC power.
3. Disconnect all internal and external batteries (if applicable).
4. Follow the shipping instructions outlined in the *Service* section of this manual.

APC by Schneider Electric IT Worldwide Customer Support

Go to the APC Web site, www.apc.com for country specific customer support.

Warranty

The standard warranty is two (2) years from the date of purchase. Schneider Electric IT (SEIT) standard procedure is to replace the original unit with a factory reconditioned unit. Customers who must have the original unit back due to the assignment of asset tags and set depreciation schedules must declare such a need at first contact with an SEIT Technical Support representative. SEIT will ship the replacement unit once the defective unit has been received by the repair department, or cross-ship upon the receipt of a valid credit card number. The customer pays for shipping the unit to SEIT. SEIT pays ground freight transportation costs to ship the replacement unit to the customer.