

## Features

- Includes faceplate with metal cross handle
- A single handle controls both on/off activation and temperature setting
- Metal cross handle
- Coordinates with Artifacts faucets and accessories

## Material

- Premium material construction with metal handle ensures reliability and durability

## Installation

- Trim only; requires valve to complete installation (sold separately)

## Required Products/Accessories

K-8304 Series Rite-Temp® Valve & Cartridge Kits

or

K-8300 Series Rite-Temp® Valve Body Rough-ins

or

K-8300 Series Rite-Temp® Valve Body Rough-ins

K-8305 Series Rite-Temp® Cartridges

or

K-8300 Series Rite-Temp® Valve Body Rough-ins (Qty 2)

K-8305 Series Rite-Temp® Cartridges

or

K-8305 Series Rite-Temp® Cartridges

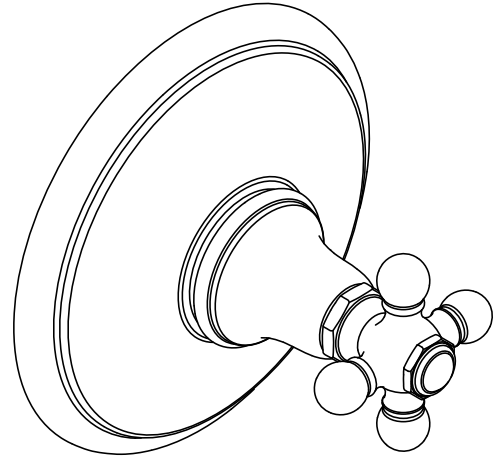

**ADA**

## Codes/Standards

ASME A112.18.1/CSA B125.1

ADA





ICC/ANSI A117.1

## KOHLER® Faucet Lifetime Limited Warranty

See website for detailed warranty information.

## Available Colors/Finishes

*Color tiles intended for reference only.*

Color	Code	Description
	CP	Polished Chrome
	SN	Vibrant® Polished Nickel
	BN	Vibrant® Brushed Nickel
	BV	Vibrant® Brushed Bronze
	DR	Deep Bronze

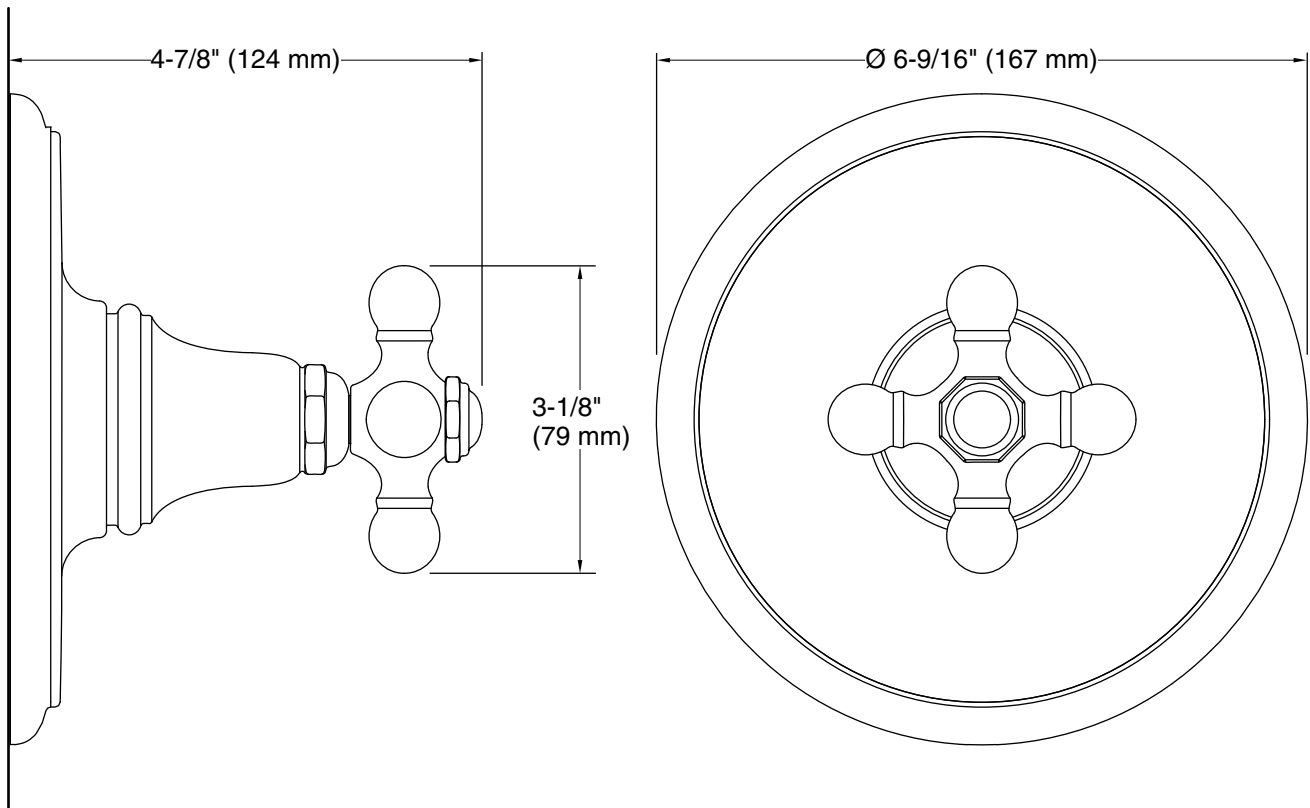

### Technical Information

All product dimensions are nominal.

### Spout:

### Notes

Install this product according to the installation instructions.

ADA compliant when installed to the specific requirements of these regulations.