

# ASSEMBLY INSTRUCTION

## SOFA

**A** Sofa

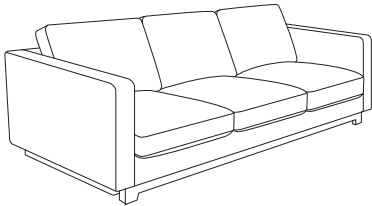

**B** Leg



1 pc

**C** Bolt  
Ø1/4"×2"

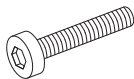

4 pcs

**D** Lock Washer  
1/4"



8 pcs

**E** Flat Washer  
1/4"

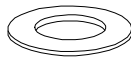

8 pcs

**F** Allen Wrench  
1/4"

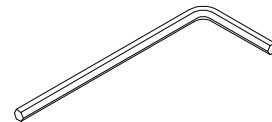

8 pcs

1 pc

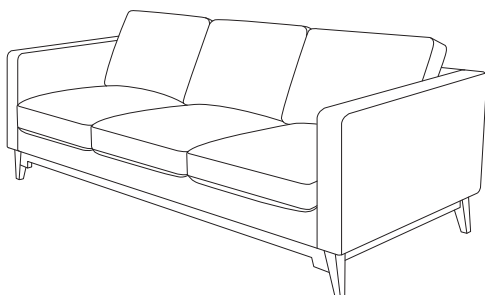

This page lists all the contents included in the box. Please take the time to identify the hardware as well as the individual components to this product. As you unpack and prepare for assembly, place the contents on a carpeted or padded area to protect them from damage.

**1**

Upside down the Sofa (A) on a carpeted or padded area. Take out 4pcs Leg (B) from the box.

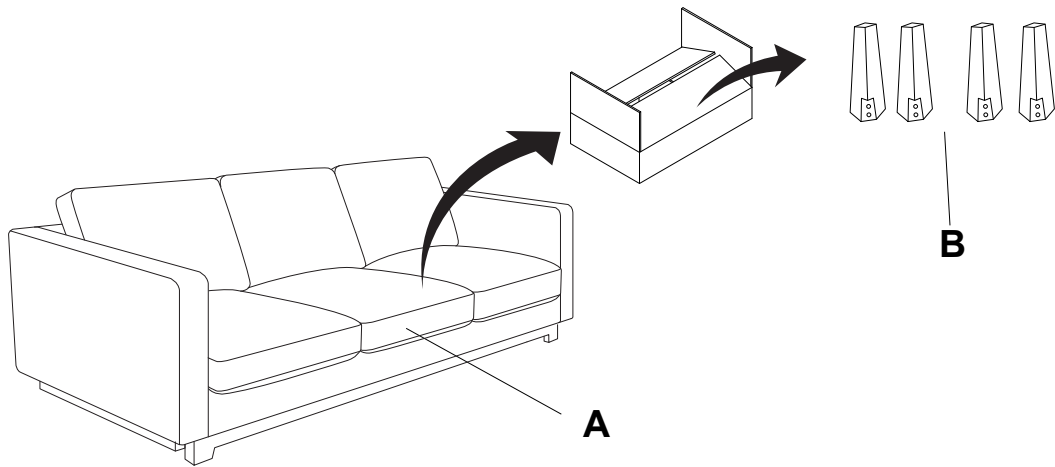
**2**

Put the Sofa (A) on a smooth flat surface and attach Leg (B) to the Sofa (A) using Bolt (C), Lock Washer (D) and Flat Washer (E) on both holes of Sofa (A). Turn the Allen Wrench (F) in Bolt (C).

Take the Allen Wrench, and turn the bolts until the legs are secured.  
DO NOT TIGHTEN COMPLETELY.  
Stop when you feel you are adding force to tighten the bolt.

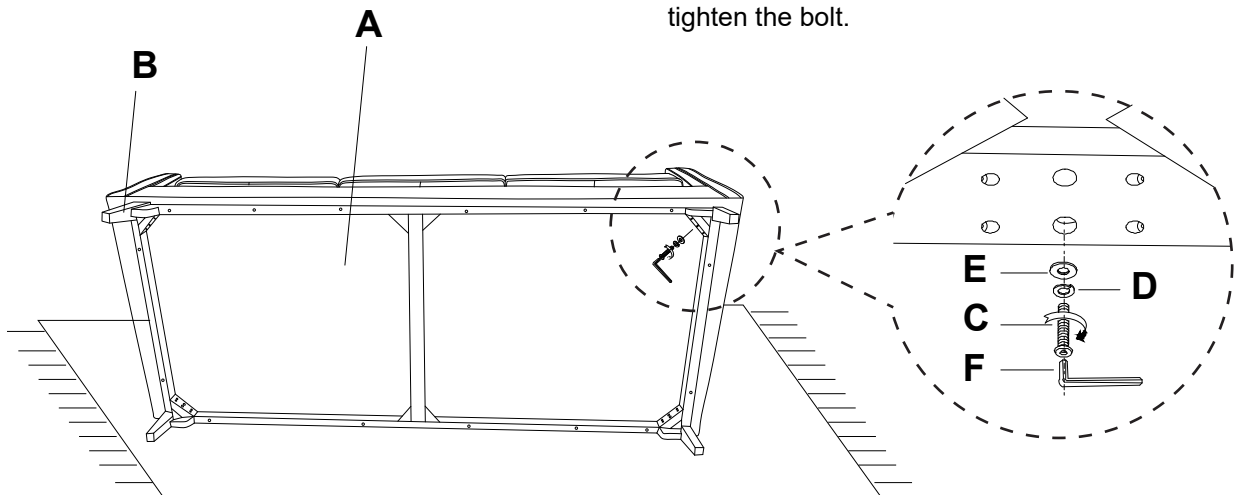

Stand sofa up on an even surface and check that it is balanced. If there is a slight wobble, apply downward pressure in the corner where a leg is uneven. Keeping pressure in that corner, tighten all bolts. If balanced, apply downward pressure evenly in the center and tighten all bolts. Do not over-tighten beyond hole depth.

**Helpful Tip:**  
-Instead of applying downward pressure while reaching under to tighten bolts, have someone sit in the sofa while you tighten the bolts.

---

**3**

Two people are required to orientate the sofa on an even surface and check that it is balanced.

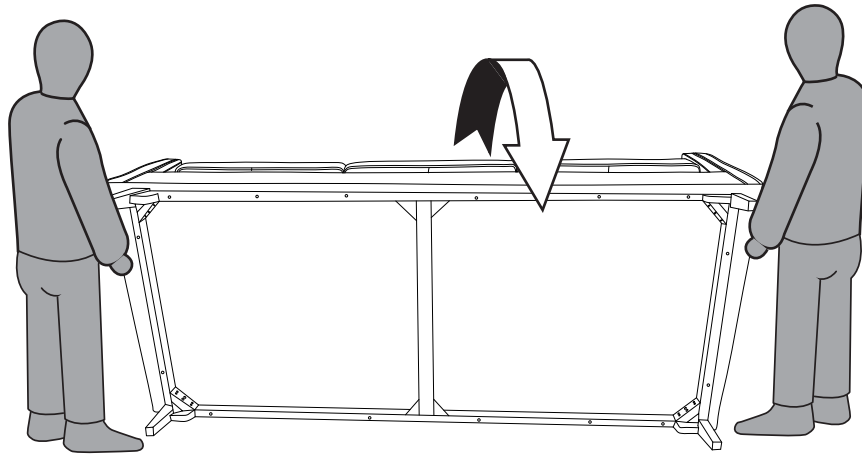

---

**Cleaning & Care**

Treat surface with care. Clean surfaces with a dry or damp soft cloth. Do not use abrasive cleaners. Hardware may loosen over time. Periodically check that all connections are tight.