





H O M E E L E G A N C E



ASSEMBLY INSTRUCTION



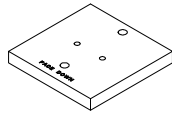

5492-52 DINING TABLE

Thank you for purchasing this product. Please take time to read and follow the instructions below. Check that you have all parts and hardware before assembly. Parts apparently missing are often found in the packing materials. If you do not have all the parts listed, have your dealer contact us and they will be sent to you immediately.

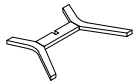
 It is recommended to install protective pads under all legs and supports to avoid damage or scratches when placing furniture on a wood floor or other hard surface, and to limit indentation and prevent discoloration if placing on carpet.

 Do not tighten bolts until completely assembled.

PART LIST			
A		TABLE TOP	1PC
B		MOUNTING PLATE	4PCS
C		UPPER LEG	1PC
D		LOWER LEG	1PC

HARDWARE LIST			
1		BOLT 5/16"-18x3"	1PC
2		BOLT 5/16"-18x1-1/2"	16PCS
3		SPRING WASHER 5/16"x11/32"x11/16"x1/16"	17PCS
4		FLAT WASHER 5/16"x21/61"x3/4"x5/64"	17PCS
5		ALLEN KEY 1"x2-1/3"	1PC

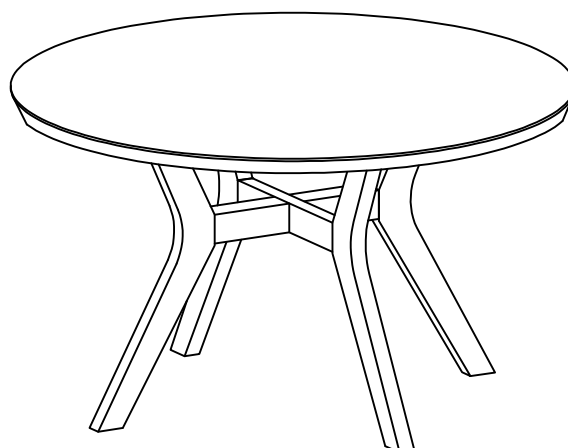



HOMELEGANCE

ASSEMBLY INSTRUCTION

5492-52 DINING TABLE

Step 1/

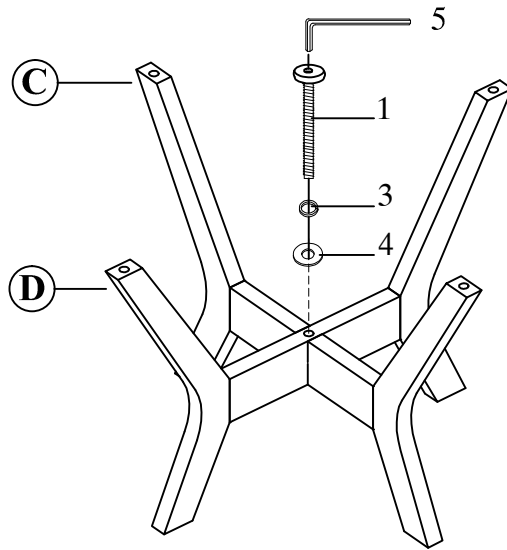

Step 2/

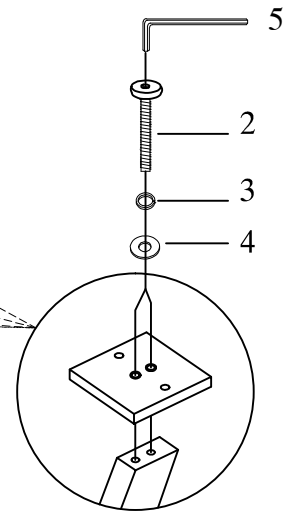
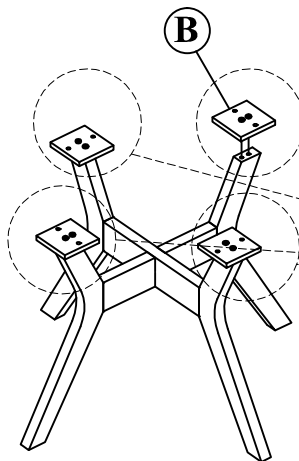
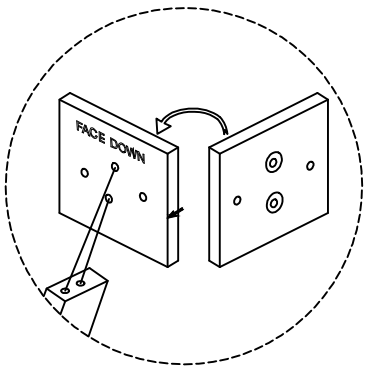

Step 3/

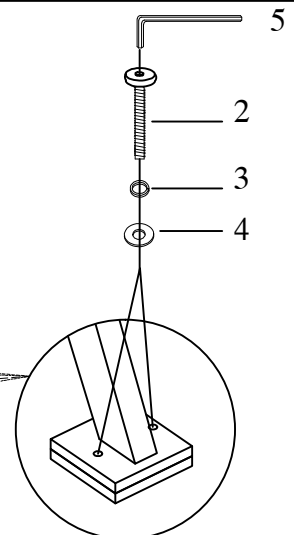
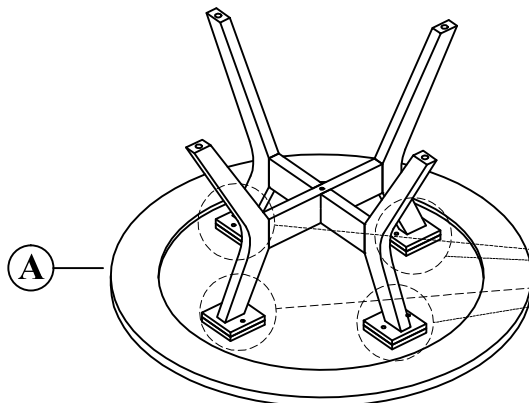

MADE IN VIETNAM