



Text 1-812-203-4747  
(US and Canada only, carrier fees may apply)



Visit [maxicosi.com/connected-support](https://maxicosi.com/connected-support)



Call 1-800-544-1108



Email [connected@maxicosi.com](mailto:connected@maxicosi.com)



Learn More

©2024 Dorel Juvenile Group, Inc. (800) 544-1108 [www.maxicosi.com](https://www.maxicosi.com). Styles, colors, and labeling may vary. Made in China. Distributed by Dorel Juvenile Group, Inc., 2525 State St., Columbus, IN 47201-7494. Dorel Juvenile Canada, 2233 Argenta Road, Suite 110, Mississauga, ON L5N 2X7. Representante exclusivo en Chile: DOREL JUVENILE CHILE S.A. Av. del Parque 4161, oficina 602 A, Huechuraba, Santiago, Chile - Fono: 56 2 24971500 - [www.infanti.cl](http://www.infanti.cl) - [www.dorel.cl](http://www.dorel.cl). Importado y distribuido en Perú por: COMEXA COMERCIALIZADORA EXTRANJERA S.A. SUCURSAL DEL PERÚ - Los Libertadores 455, San Isidro, Lima 27, Lima, Perú RUC 20431062870 - Fono: 4413029 - [www.infanti.com.pe](http://www.infanti.com.pe). En Centro América, Caribe y Ecuador por: Best Brands Group S.A. - Av. Balboa, Bay Mall Plaza, Planta Baja, local 9, Panamá. - Fono: (507) 300 2884. En Colombia por: Baby Universe S.A.S. - Vía 40 No. 77-29, Barranquilla, Colombia - Fono: (575) 353 1110 Importador: DJGM, S.A. DE C.V. Gabriel Mancera No. 1041 Col. Del Valle, Benito Juárez C.P. 03100 México, Ciudad de México R.F.C. DJG140305GN9 Tel. (55) 67199202 03/24 4358-8510



**MAXI-COSI**<sup>®</sup>  
KINDRED COLLECTION

**Starling**  
Smart Bassinet  
featuring CryAssist™



BT099

Keep these instructions for future reference.



Introducing  
the Maxi-Cosi  
Kindred Collection

MAXI-COSI

Our Maxi-Cosi Kindred Collection is inspired by the ancestry, connection, and inseparable bonds of Family. When you choose to invite us into your home, you allow us to become a part of your life.

These pieces are more than furniture or baby products—they're carriers and keepers of cherished memories and family ties. Their exceptional quality and craftsmanship mean that the memories they'll make are countless. Each Maxi-Cosi Kindred Collection piece is thoughtfully created, reflects a timeless design, features special metals and EcoCare premium, recycled fabric made from plastic bottles, and is meant to be loved and shared.

The Maxi-Cosi Kindred Collection  
Lineage in design.

## Table of Contents

|                                          |    |
|------------------------------------------|----|
| WARNINGS .....                           | 7  |
| ASSEMBLY .....                           | 11 |
| Parts .....                              | 12 |
| Legs .....                               | 14 |
| Bassinet Basket .....                    | 15 |
| Plugging in .....                        | 17 |
| USE .....                                | 19 |
| Navigating the Touch Panel .....         | 20 |
| Locking the Touch Panel .....            | 20 |
| Resetting your Bassinet .....            | 20 |
| Pairing with your Smartphone .....       | 21 |
| Wi-Fi Connectivity for Smartphones ..... | 21 |
| Power .....                              | 22 |
| Motions .....                            | 22 |
| Sleep Modes .....                        | 22 |
| Sounds and Music .....                   | 23 |
| Enabling the Bluetooth® Speaker .....    | 24 |
| Scenes .....                             | 25 |
| Timer .....                              | 25 |
| CARE AND MAINTENANCE .....               | 27 |
| Replaceable Parts .....                  | 28 |
| Warranty Information .....               | 29 |
| Disposal .....                           | 29 |
| FCC Statement .....                      | 30 |

See back cover for contact information and support.

## Features of Your Starling Smart Bassinet



**Includes 6 months of CryAssist  
cry translation service**

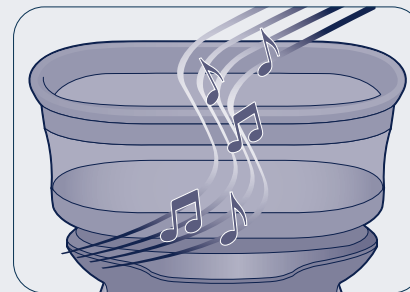

**Activates sounds  
and motions when  
baby is crying to  
help pacify your  
little one**

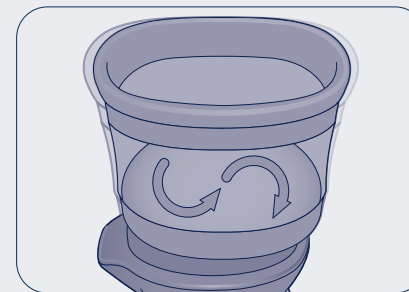

**Gently calm  
your baby with 5  
natural rocking  
motions, each  
with 3 speeds**

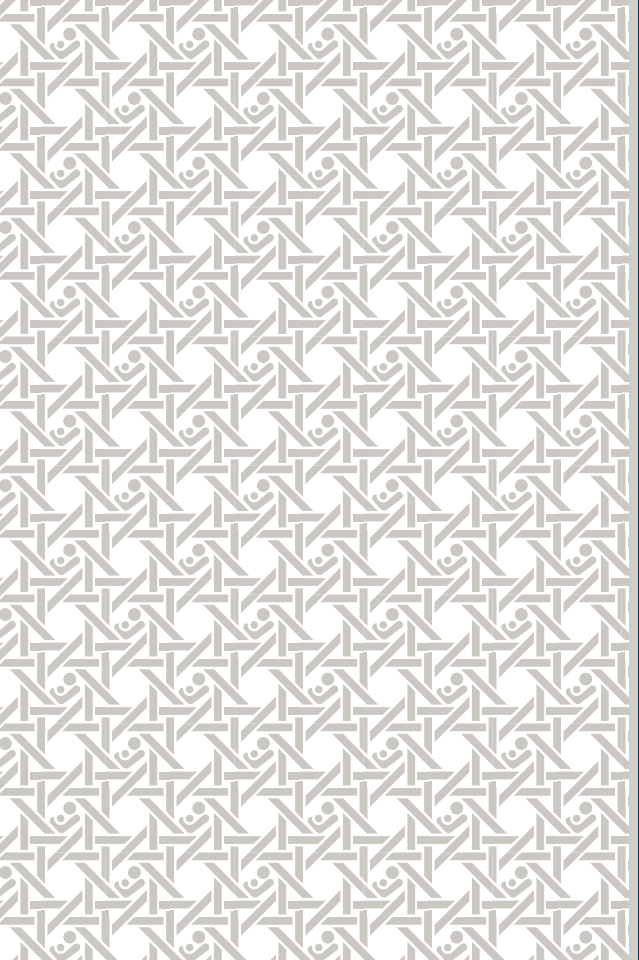

# Warnings



For indoor use only. Suitable for infants up to 20 lbs.

Read all instructions before assembly and use of product. Keep instructions for future reference.

## **⚠ WARNING**

Failure to follow these warnings and the instructions could result in death or serious injury.

# **SUFFOCATION HAZARD**

## **Babies have suffocated:**

- On pillows, comforters, and extra padding.
  - In gaps between a wrong-size mattress, or extra padding and product sides.
  - **NEVER** add soft bedding or padding.
  - Use **ONLY** mattress provided by manufacturer.
  - **ALWAYS** place baby on back to sleep to reduce the risk of SIDS and suffocation.
- FALL HAZARD**—To help prevent falls, do not use this product when the infant begins to push up on hands and knees or has reached 20 lbs, whichever comes first.
- If a sheet is used with the pad, use only the one provided by the product manufacturer or one specifically designed to fit the dimension of the product mattress.

## **⚠ WARNING**

- Strings can cause strangulation! **DO NOT** place items with a string around a child's neck, such as hood strings or pacifier cords. **DO NOT** suspend strings over a product or attach strings to toys.
- **DO NOT** use if any part of the bassinet is broken, torn, or missing. Contact Consumer Care for replacement parts and instructional literature if needed.
- To reduce the risk of fire or electrical shock, **DO NOT** expose this product to water or moisture.
- This monitor function is not intended to be used as a medical monitor and its use should not replace proper adult/parental supervision. You should check your child's activity at regular intervals as this monitor will not alert parents to the silent activities of a child.
- **NEVER** attempt to disassemble the product. This is dangerous and will void the warranty.
- Test monitor function periodically when in use and changing locations.
- Use only the adapter supplied with this product. Incorrect adapter polarity or voltage can seriously damage the product.
- To prevent entanglement and overheating, **DO NOT** use extension cords.
- The adapter and device may become slightly warm to the touch during operation. This is normal.
- **ALWAYS** unplug the AC adapter from the wall during extended periods of non-use.
- Check to make sure wall outlet plates are not unusually hot to the touch. If they are, immediately unplug cords from these outlets.
- Check that all outlet connections are in good condition so that adapter is not loose or that no wiring is exposed. Have a qualified, licensed electrician check the wiring as soon as possible.
- This monitor allows internet users to hear activity. Use the security feature included with this device to restrict internet viewership.
- **DO NOT** place adapter/wall plug under a window where a child might use it to step on and/or to reach something that might be dangerous.



Assembly

## Parts

- A Wood leg with electrical plug (1)
- B Wood legs (3)
- C Bassinet basket
- D Mattress pad and cover
- E Power cord

Adult assembly required.  
No tools required.

Download our easy-to-use  
Connected Family app, where you  
can manage your Starling Smart  
Bassinet and all other Maxi-Cosi  
Connected devices.



[Learn More](#)

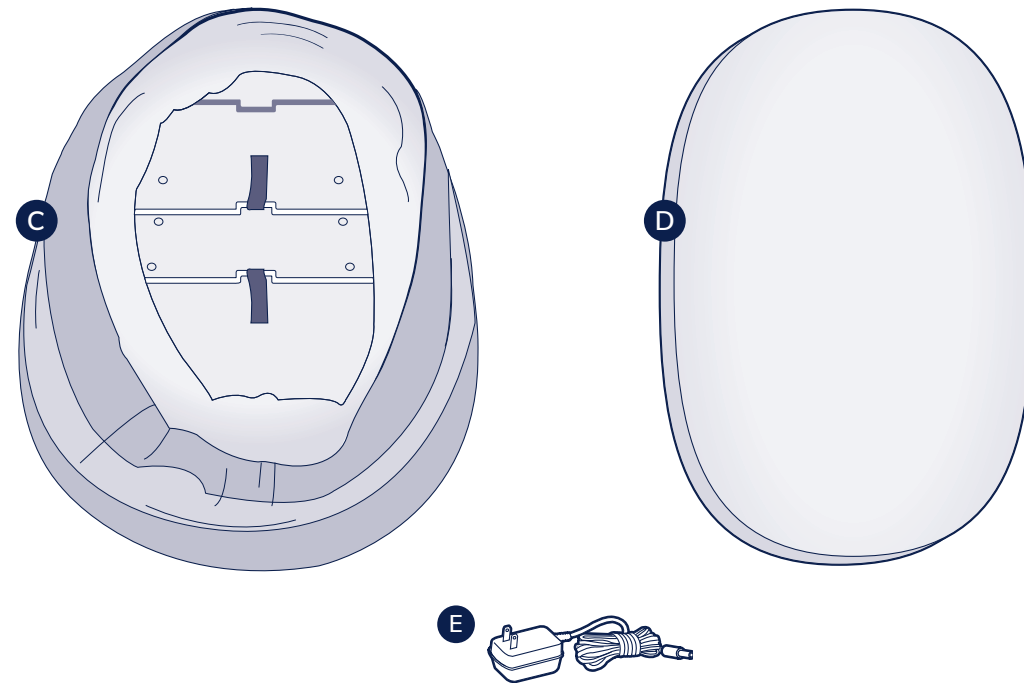

## Assembly

### Legs

On a flat, clean surface, turn the bassinet upside down, and identify the four leg openings.

While pressing in the pin, insert the wood leg with electrical plug into the ribbed opening (Figure 1) until you hear the pin click into position. Pull on the leg to ensure it is locked in place.

Repeat with the other three legs (Figure 2), pulling on each to ensure they are locked in place. **Note:** These three legs are interchangeable.

Once all four legs are in place, turn the bassinet right side up (Figure 3).

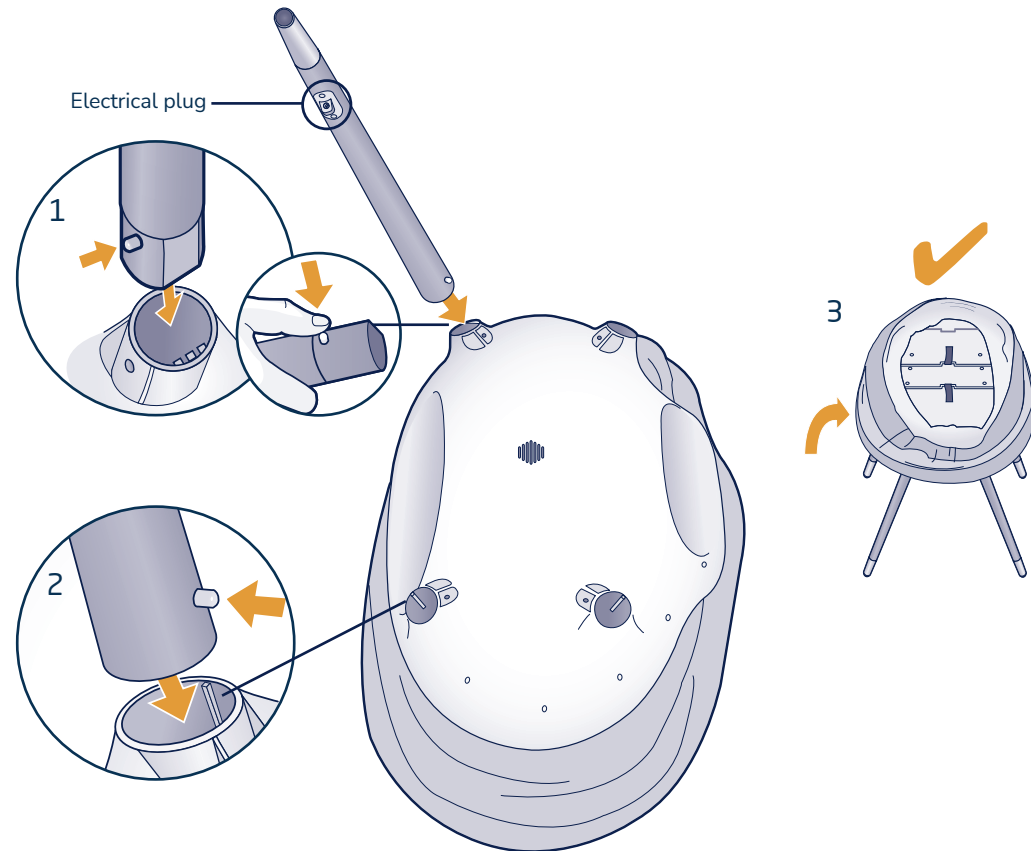

## Assembly

### Bassinet Basket

To assemble the bassinet basket, lift the rim up with both hands (Figure 1).

While holding the rim with one hand (Figure 2), pull one tab towards the end of the bassinet until the bar enters the slot (Figure 3). Repeat with the other tab (Figure 4). Confirm that both tabs are securely in place by pushing the rim down and ensuring the bassinet does not collapse.

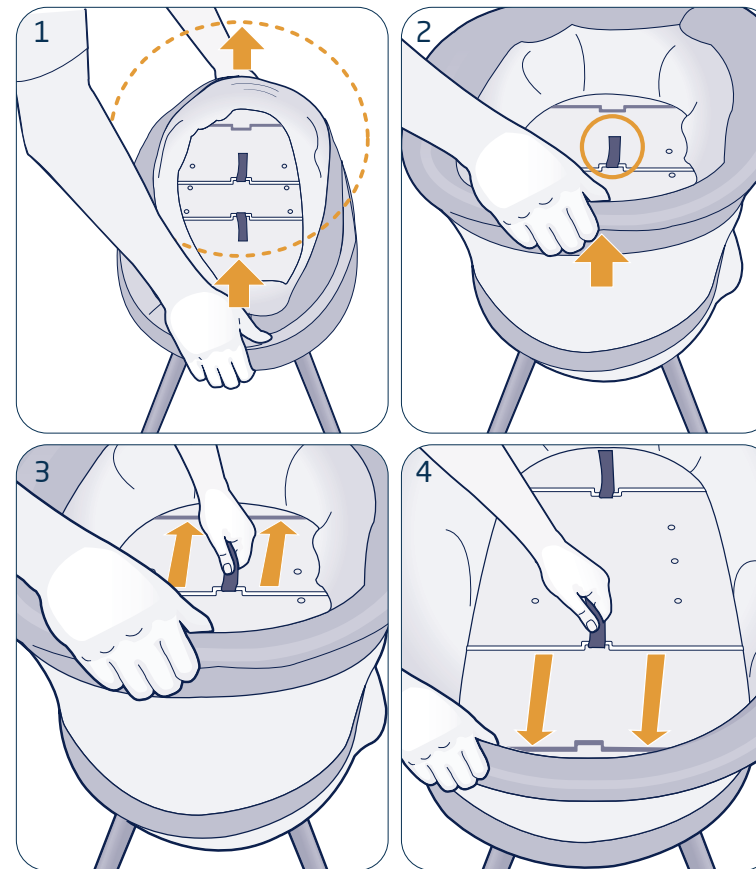



## Assembly

### Bassinet Basket

On each side of the bassinet, snap the bottom of the mesh sides to the base to secure (Figure 5).

Place the mattress pad with cover into the bassinet (Figure 6).

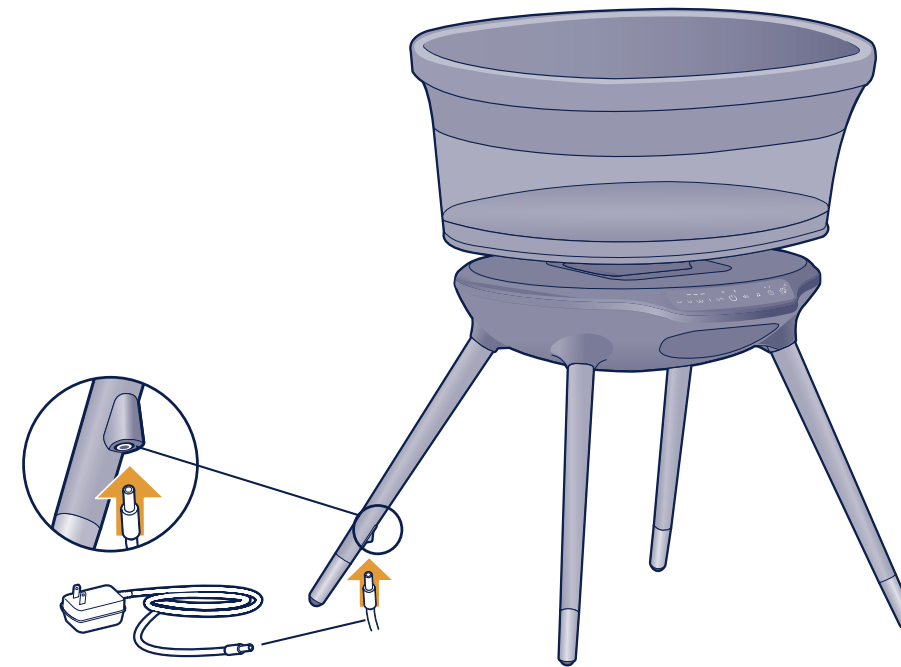
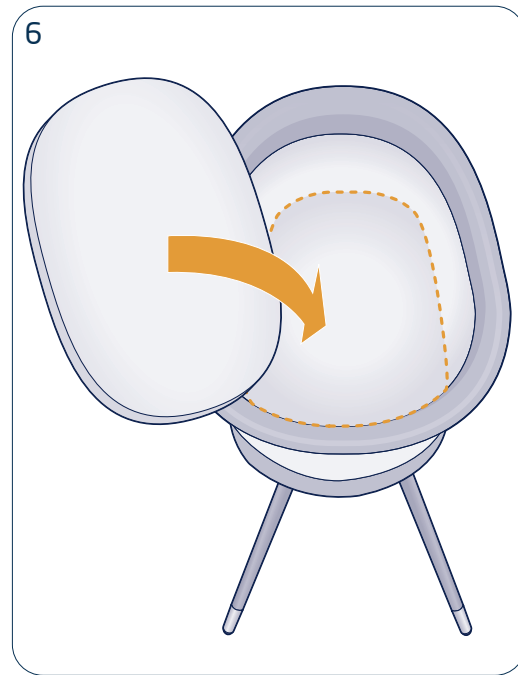
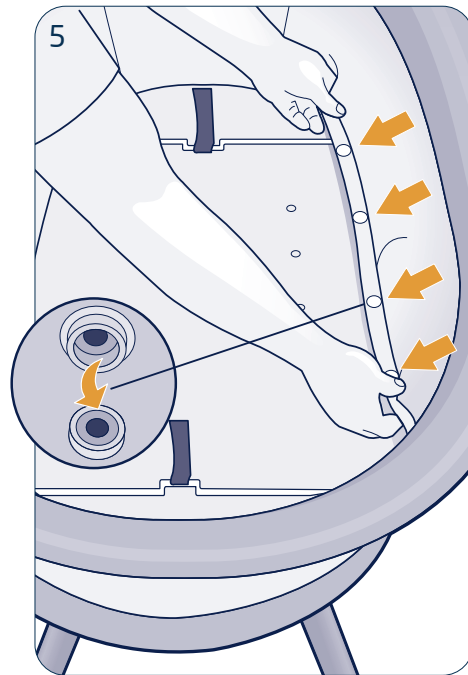

**⚠ WARNING**

**STRANGULATION HAZARD**

- Children have **STRANGLED** in cords.
- Keep this cord out of the reach of children.

## Assembly

### Plugging in

Plug the power adapter into a nearby wall outlet, and insert the other end of the plug into the port on the leg.

**Power adapter:**  
Input: 110 VAC 50/60Hz  
Output: 12 VDC 3A (Bassinet input)



## Navigating the Touch Panel

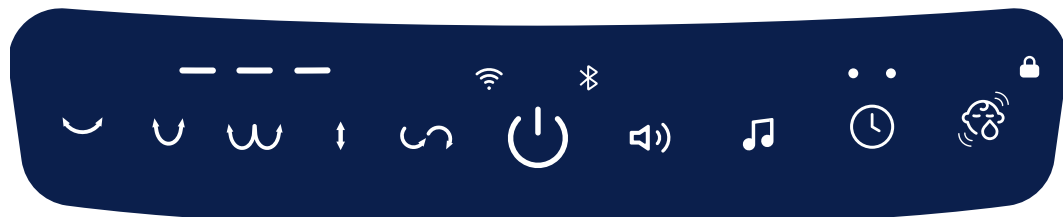

### Motion 1 — Cradle

Lulls your child back and forth.



### Motion 2 — Sway

Rocks from side to side.



### Motion 3 — Flutter

Loops out and around.



### Motion 4 — Cascade

Gently lifts up and down.



### Motion 5 — Zephyr

Wafts in an arc and curls back.



### Motion Speed Indicators



### Wi-Fi Indicator



### Power



### Bluetooth® Speaker



### Volume



### Sounds and Music



### Timer



### Timer Indicators





### Scenes





### Lock/Unlock Indicator





## Locking the Touch Panel

To lock and unlock the touch panel, press and hold the Timer icon  for 5 seconds. The Lock icon  will shine white at full brightness.

## Resetting Your Bassinet

To reset the bassinet to its original settings, press and hold both the Motion 1  and the Power icons  for 20 seconds.

## Pairing with Your Smartphone

1. Download the Connected Family app to manage your Starling Smart Bassinet. Make sure your smartphone is connected to your home's Wi-Fi network.
2. In the app, tap . Then select Maxi-Cosi followed by Starling Smart Bassinet to begin pairing your device.
3. Press and hold Power  for 10 seconds. The Wi-Fi indicator  will blink white while in pairing mode.
4. Follow the step-by-step instructions in the app to complete pairing.
5. In the Connected Family app, tap  to learn more. You can also enable CryAssist, share access, configure notifications, and more.

Download the Connected Family app to manage your Starling Smart Bassinet, activate CryAssist™, and access baby diary.



**Note:** CryAssist requires an internet connection and must be set up in the Connected Family app.

## Wi-Fi Connectivity for Smartphones

Connecting to this device via your smartphone requires a 2.4 GHz, 5 GHz, or dual-band home network. Certain shared networks such as those in hotels may not function. We recommend a connection with network speeds of 2 Mbps or greater at the location the device will be installed. Your internet service provider can verify the quality of your internet connection.



### Power

Tap the Power icon  to turn the bassinet on. Both the Power icon and the Wi-Fi indicator (if paired with your smartphone) will shine white. All other icons will be dim until activated. **Note:** The device will enter standby after 8 hours of continuous motion, without interaction on the touch panel or app.

### Motions

The Starling Smart Bassinet includes 5 motions with 3 speeds each. Tap a motion icon to begin movement. Additional taps on the same motion will increase the speed. The 4th tap turns the motion off and returns the device to the home position.

### Sleep Modes

The touch panel will enter Sleep Mode after 15 seconds of inactivity and all active functions will dim (inactive icons will remain off). Tap any icon to wake, showing all active icons with full brightness and all inactive icons dimmed.

While in Night Mode, the Power icon will be dimmed with all other icons turned off. This mode can be activated in the Connected Family app.



### Sounds and Music

Tap the Sounds and Music icon  to cycle through the 5 soothing built-in sounds. Press and hold the Sounds and Music icon for 2 seconds to turn sounds off.

When Bluetooth® is ON and paired with your smartphone, you can stream any media or music through the speaker. Tap the Sounds and Music icon to Play/Pause Bluetooth sound playback. Press and hold the Sounds and Music icon for 2 seconds to return to the built-in sounds.

Volume is controlled through the Volume icon , with each tap cycling through the 5 different levels. The 6th tap turns the volume off.



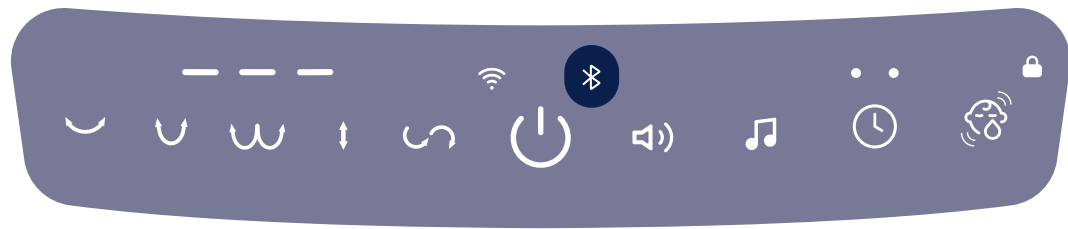

### Enabling the Bluetooth® Speaker

To enter Bluetooth pairing mode, press and hold the Bluetooth icon  for 10 seconds. The Bluetooth icon will blink while in pairing mode. 3 fast blinks indicates a failed connection. Upon entering Bluetooth pairing mode, the device will chime. A subsequent chime will play when Bluetooth is successfully paired.



While connecting, the Bluetooth icon will blink constantly. When connected, the Bluetooth icon will remain solid white.



Open the Bluetooth menu on your smartphone and select Maxi-Cosi Starling from the list of devices.

Once Bluetooth is paired, tap the Bluetooth icon to switch from playing the built-in sounds and music to using the speakers to play your own media.



### Scenes

Tap the Scenes icon  to enable the default scene. The default scene features the “Cradle” motion at Speed 1 with “Twinkle, Twinkle, Little Star” playing at Volume 2. To enable the default scene only when crying is detected, press and hold the Scenes icon  for 3 seconds. The LED will blink 3 times and the device will wait for the sound of a crying baby to activate the scene.

To save the current configuration as default, simultaneously press and hold the Power icon  and the Scenes icon  for 2 seconds. Scenes can be created and managed through the Connected Family app.

To exit the scene, tap the Scenes icon again or change to another setting.

### Timer

Tap the Timer icon  to select from 2 default timers: Timer 1 (Naptime) is 30 minutes and Timer 2 (Bedtime) is 180 minutes. The 3rd tap of the icon will disable the timer. Timers can be customized through the Connected Family app.



Care and  
Maintenance

## Care and Maintenance

### Cleaning the Bassinet Basket (A)

Unplug power cord before spot cleaning. Spot clean only the fabric and base board, using a dampened cloth. Do not use harsh cleaning products.

### Cleaning the Bassinet Base (B)

Clean with a slightly damp cloth or with an anti-static cloth. ALWAYS unplug from electrical outlet before cleaning. NEVER USE cleaning agents or abrasive solvents. DO NOT clean any part of the product with thinners or other solvents and chemicals—this may cause permanent damage to the part, which is not covered by the warranty. Keep product away from hot, humid areas or strong sunlight, and do not let it get wet. Every effort has been made to ensure high standards of reliability of your product. However, if something does go wrong, please do not try to repair it yourself—contact Consumer Care for assistance.

### Washing the Mattress Cover

Remove the cover from the mattress pad.  
Machine wash cold, gentle cycle, and line dry.

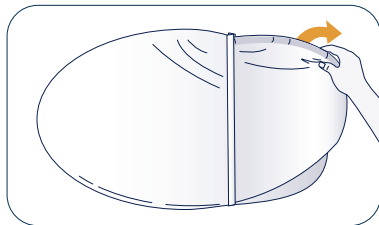

### Replaceable Parts

- Wood leg with electrical plug
  - Wood legs without electrical plug
  - Power cord
  - Mattress pad and cover
- To order parts, call 1-800-544-1108 or text 1-812-203-4747. Have the model number ready (BT099), the product serial number (found on the bassinet under the mattress pad), and a brief description of the part.

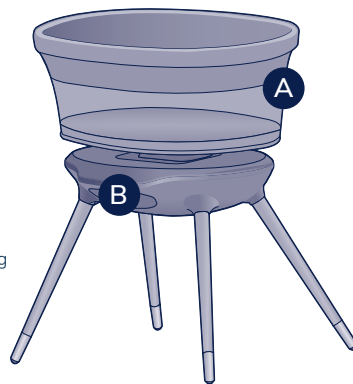

## Two-Year Limited Warranty

Dorel Juvenile Group, Inc. warrants to the original purchaser that this product (Starling Smart Bassinet) is free from material and workmanship defects when used under normal conditions for a period of two (2) years from the date of purchase. Should the product contain defects in material or workmanship Dorel Juvenile Group, Inc., will repair or replace the product, at our option, free of charge. Purchaser will be responsible for all costs associated with packaging and shipping the product to Dorel Juvenile Group Consumer Care Department at the address noted on back cover and all other freight or insurance costs associated with the return. Dorel Juvenile Group will bear the cost of shipping the repaired or replaced product to the purchaser. Product should be returned in its original package accompanied by a proof of purchase, either a sales receipt or other proof that the product is within the warranty period. This warranty is void if the owner repairs or modifies the product or the product has been damaged as a result of misuse. This warranty excludes any liability other than that expressly stated previously, including but not limited to, any incidental or consequential damages.

**SOME STATES DO NOT ALLOW THE EXCLUSION OR LIMITATION OF INCIDENTAL OR CONSEQUENTIAL DAMAGES, SO THE ABOVE LIMITATION OR EXCLUSION MAY NOT APPLY TO YOU. THIS WARRANTY GIVES YOU SPECIFIC LEGAL RIGHTS, AND YOU MAY ALSO HAVE OTHER RIGHTS THAT MAY VARY FROM STATE TO STATE.**



### Disposal

At the end of the product life cycle, you should not dispose of this product with normal household waste. Take this product to a collection point for the recycling of electronic equipment in accordance with your local laws. Some of the product materials can be reused if you take them to a recycling point. By reusing some parts or raw materials from used products, you make an important contribution to the protection of the environment.

Prior to disposal of this device, make sure to reset the device to its factory state and remove the device from your account, which will help clear the device of personal data. Remove or securely erase any storage media, such as MicroSD cards, which may contain personal data like videos, photos, and documents.



## FCC Statement

This device complies with part 15 of the FCC Rules. Operation is subject to the following two conditions:

1. This device may not cause harmful interference, and
2. This device must accept any interference received, including interference that may cause undesired operation.

### RADIO AND TELEVISION INTERFERENCE:

This equipment has been tested and found to comply with the limits for a Class B digital device, pursuant to part 15 of the FCC Rules. These limits are designed to provide reasonable protection against harmful interference in a residential installation. This equipment generates, uses and can radiate radio frequency energy and, if not installed and used in accordance with the instructions, may cause harmful interference to radio communications. However, there is no guarantee that interference will not occur in a particular installation. If this equipment does cause harmful interference to radio or television reception, which can be determined by turning the equipment off and on, the user is encouraged to try to correct the interference by one or more of the following measures:

1. Reorient or relocate the receiving antenna.
2. Increase the separation between the equipment and receiver.
3. Connect the equipment into an outlet on a circuit different from that to which the receiver is connected.
4. Consult the dealer or an experienced radio/TV technician for help.

**Note:** Changes or modifications not expressly approved by Dorel Juvenile Group can void your authority to operate this equipment under Federal Communications Commission's rules.

Use of other accessories may not ensure compliance with the FCC exposure guidelines.

**FCC Radiation Exposure Statement:** This equipment complies with FCC radiation exposure limits set forth for an uncontrolled environment. This transmitter must not be co-located or operating in conjunction with any other antenna or transmitter.

The Bluetooth® word mark and logos are registered trademarks owned by Bluetooth SIG, Inc. Other trademarks and trade names are those of their respective owners.

