

HEKMAN

ASSEMBLY INSTRUCTION 23103-LAMP TABLE

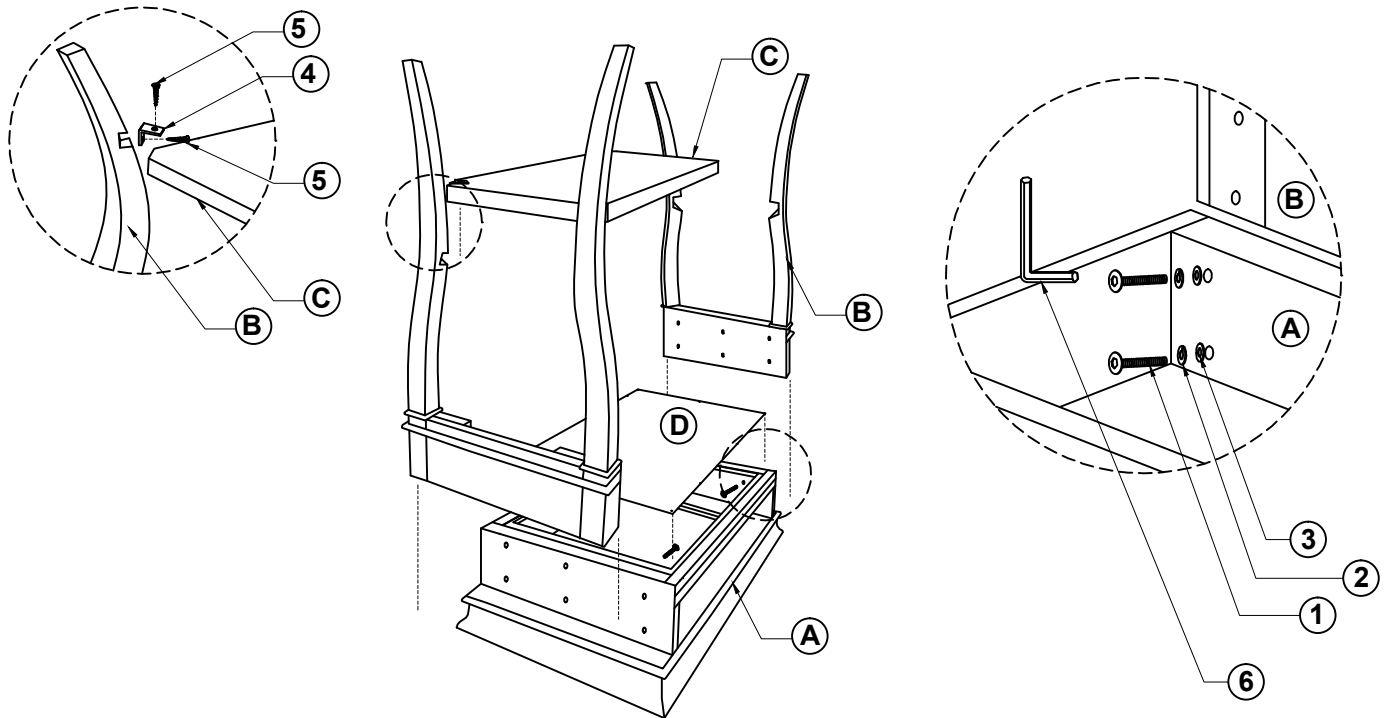

TO ASSEMBLE : (Two People Required)

Step 1 : Remove drawers and turn the table (A) upside down on a soft, clean surface

Step 2 : Remove Dustproof Panel (D) for allowing access and for installing the legs (B).

Step 3 : Attach leg (B) to each side table using the JCBC bolts(1) with lock washer(2) and a flat washer(3). Do not tighten until shelf is attached.







Step 4 : Use the Screw, Metal tab(4) to assemble the legs(B). Line up the holes metal tab(4) with the bottom shelf, then tighten with screw driver.

Step 5 : Reinstall the Dustproof panel (D).

Step 6 : Carefully turn the table upright and insert drawers into position.

HARDWARE LIST

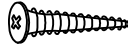

Part	Item	Description	Qty
1.		JCBC Bolt M6 x 45 mm	12 pcs
2.		Lock Washer M6	12 pcs
3.		Flat Washer M6	12 pcs
4.		Metal Tab	4 pcs
5.		Screw 1/2 "	8 pcs
6.		Allen Wrench	1 pc