



HOME ELEGANCE

Assembly Instruction





ITEM NO.:9407DG-3R

RSF 3-Seater with pull-out bed

 Legs and hardware are stored in the bubble bag and located underneath the trundle, please take out for assembly.

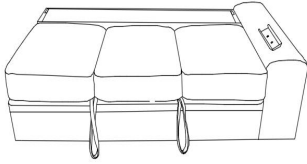
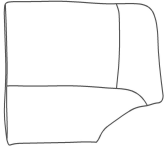
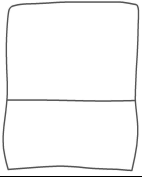
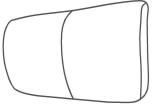
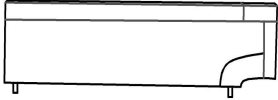
Note: Do not use power tools for assembly. Power tools increase the risk of over tightening which lead to splitting or cracking the wood

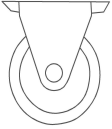
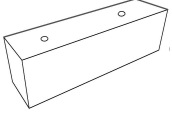
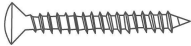
Component list .

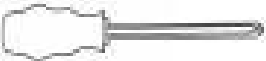
Label	Picture	Description	QTY(pc)
A		RSF 3- Seater	1
B		RSF Back Cushion	1
C		LSF/Middle Back Cushion	2
D		RSF Arm	1
E		Back Rest	1
F		Plastic leg φ1.96"*1.96"	2
G		Caster	4
H		Plastic Leg 7.08"*1.96"*1.96"	2
I		Screw φ0.15"*1.96"	6
J		Screw φ0.15"*0.98"	16
K		Screwdriver	1

Step #1

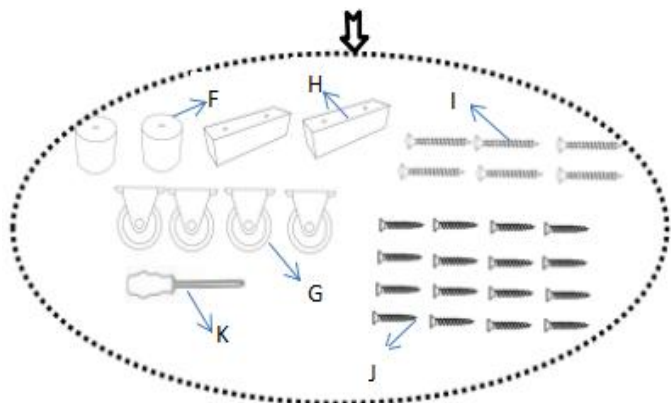
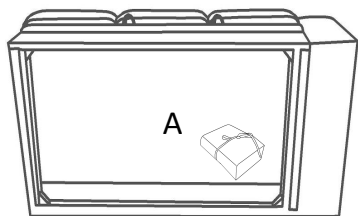

Step #2

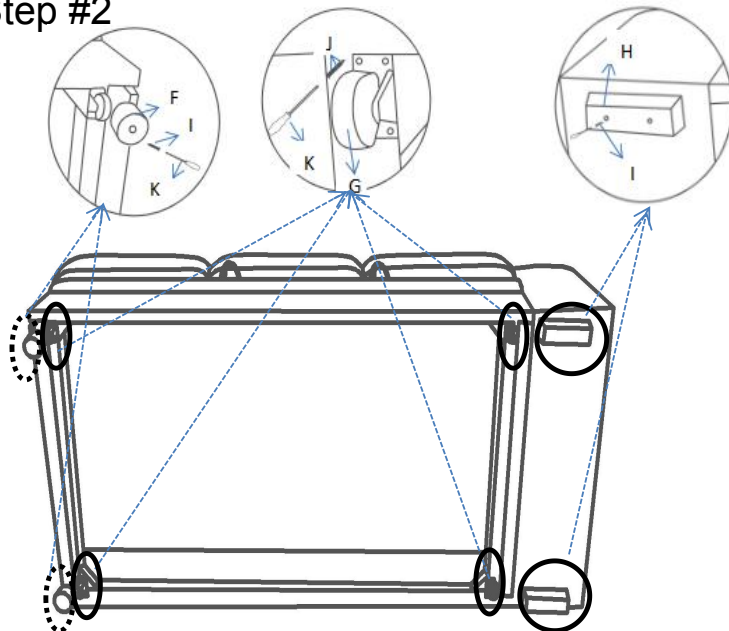

Step #3

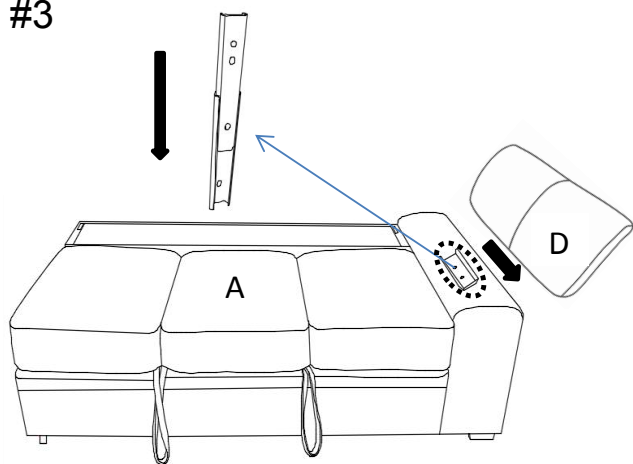

Step #4

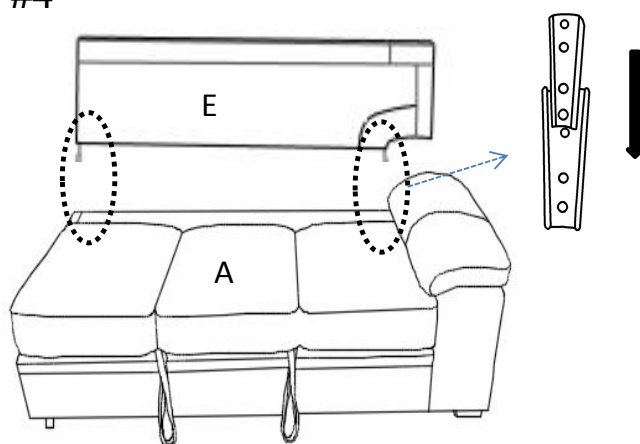

Step #5

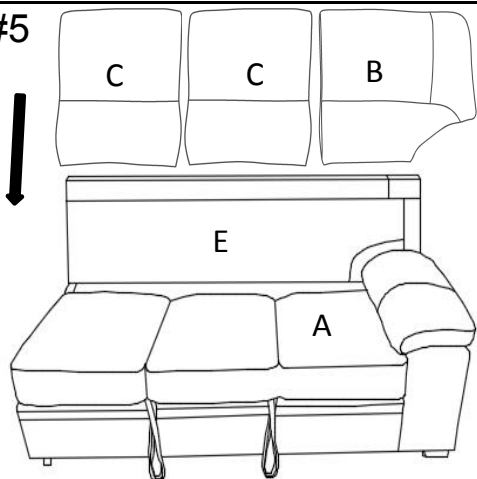

Step #6

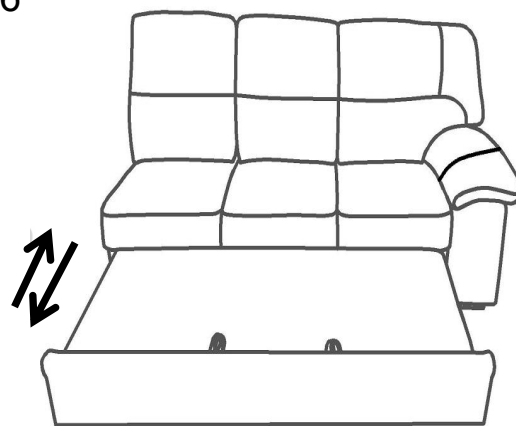

Care Instruction for Fabric Furniture:

In order to maintain the original appearance of your fabric furniture, please follow below simple care procedures:

- Avoid exposing furniture directly to sunlight or heating and air conditioning outlets. Sunlight and or exposure to heating and air conditioning outlets will fade/damage fabric.
- Vacuum or wipe with a soft cloth to remove dust.



For item use on wooden floor, hard surfaces or carpets, it is recommended to install protective pads under all legs and supports to avoid/prevent from damages/scratches and discoloration.