

ASSEMBLY AND INSTALLATION INSTRUCTIONS

T0661

WARNING: Turn off the main power at circuit breaker before installing fixture.
AVERTISSEMENT: Coupez la source d'alimentation principale au panneau central de disjoncteurs avant d'installer le luminaire.

NOTE: 1. Before installing, consult local electrical codes for wiring and grounding requirements.
2. READ AND SAVE THESE INSTRUCTIONS.

Hardware Package (included):

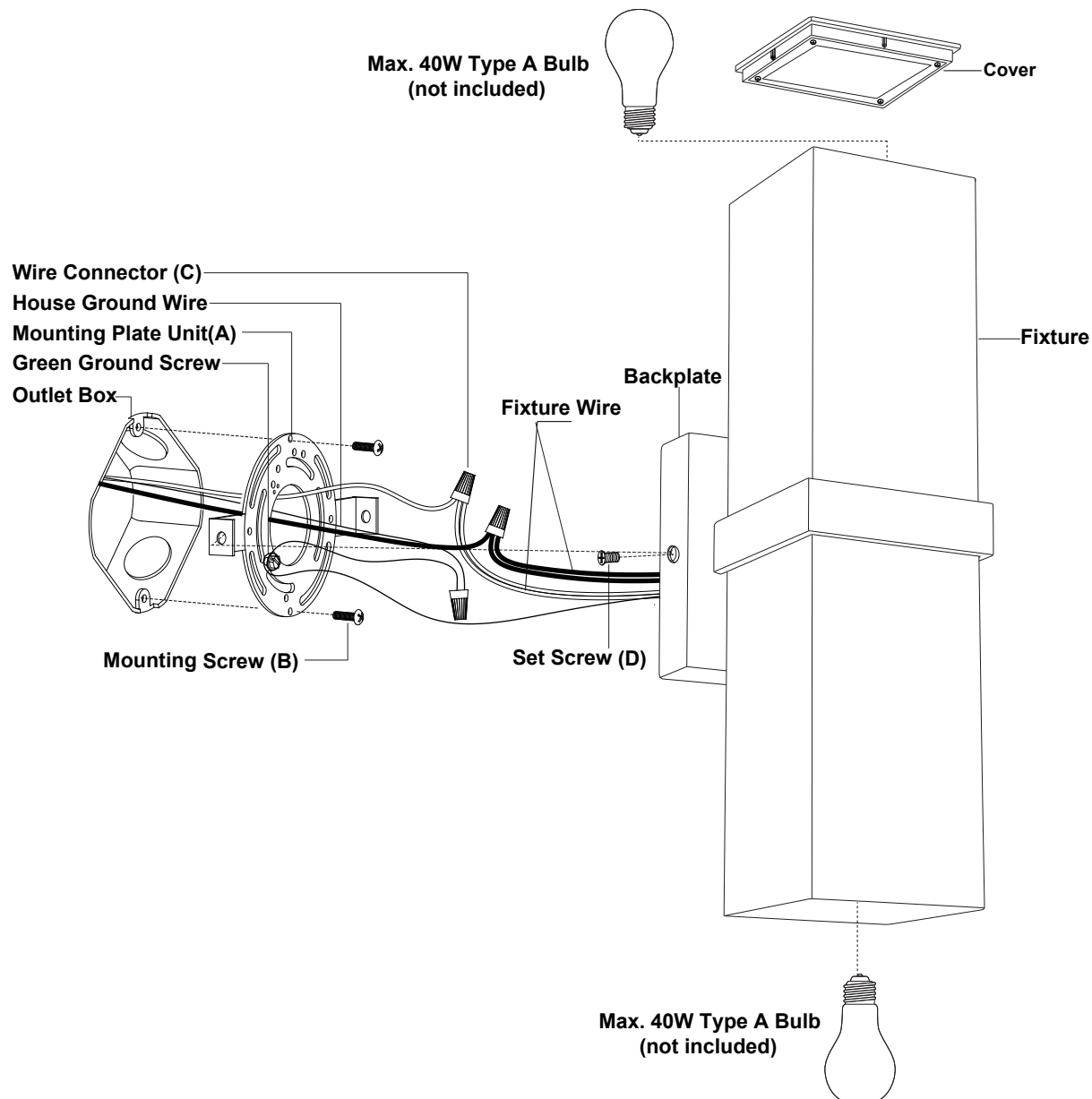
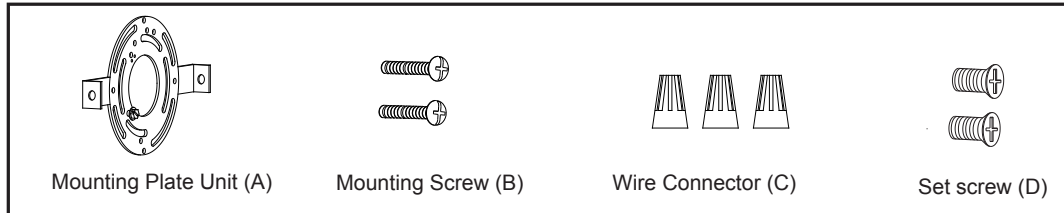

Installation Steps

Turn off the power at fuse or circuit box



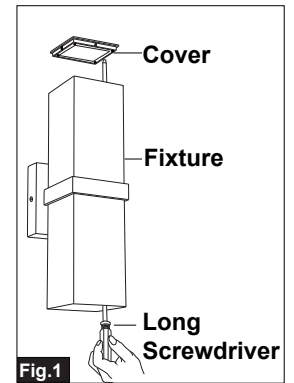

1. Unscrew the two set screws (D) and remove the mounting plate unit (A) from the backplate.
2. Attach the mounting plate unit (A) to the outlet box by using two mounting screws (B).
Note: Make sure that two set holes are lined up horizontally to make the fixture level.
3. Pull out the source wires from the outlet box. Make wire connections using wire connectors (C) as follows:
 - Connect the hot wires (black insulation) from the fixture to the black wire from the power source.
 - Connect the neutral wires (white insulation) from the fixture to the white wire from the power source.
 - Attach the fixture ground wire (bare wire) to the mounting plate unit (A) with the green ground screw, then depending on local code, connect it to the house ground wire with the wire connector (C).Carefully put all of the wires back into the outlet box.
4. Attach the backplate of the fixture to the mounting plate unit (A) by aligning holes, secure the two set screws (D) from the side hole of the backplate into the hole in the side of the mounting plate unit (A).
Note: With silicone caulk compound, caulk completely around where the backplate meets with the wall surface to prevent water from seeping into the outlet box.
5. Remove the cover from the fixture.
6. Install the bulbs (not included). See relamping label at socket area or packaging for maximum wattage allowed.
Note: If the top cover is stuck when replacing the top bulb, use a long screwdriver to push the cover's metal edge out from the inside. Be careful to avoid touching the glass with the screwdriving to avoid breakage. (See Fig.1)
7. Attach the cover back to the top of the fixture carefully.

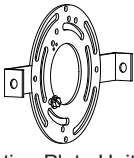

Turn on the power at fuse or circuit box

The following parts are available for re-order if damaged or missing.

Spare Parts List:

			
Mounting Plate Unit (A)	Mounting Screw (B)	Wire Connector (C)	Set screw (D)

Assembly Kit 6594MM (1 SET)

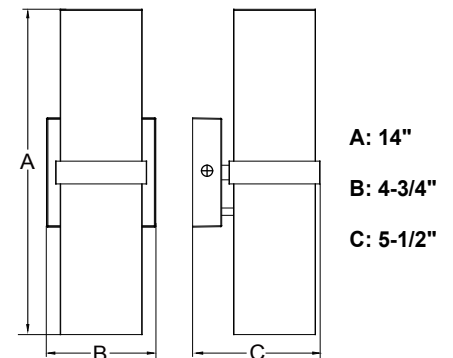

1 Year Warranty

Vaxcel warrants all of our products against defects in workmanship and finishes for one year following the date of shipment.

Exclusions: This warranty does not include the failure of products from extreme acts of nature; environmental conditions not suited for the products intended use; operation in temperatures outside of the range specified in the instruction manual; usage with improper power supply, power surges or dips. For coastal locations, some corrosion is considered normal for the environment.

Vaxcel reserves the right to repair, replace or issue a credit for any properly installed product, provided it is returned per RMA instruction. This warranty is limited to the cost of the product only and does not extend to transportation, installation or replacement costs.

How can warranty service be obtained?

info@vaxcel.com
1-800-482-9235

