



Fabriquée par:  
Backyard Discovery  
3305 Airport Drive, Pittsburg, KS 66762  
800-856-4445

Basepoint Business Centre: Rivermead Drive, Westlea, Swindon SN5 7EX Phone: 0800-118-2476  
J.P. Coenstraat 7, The Bridge, The Hague, 2595 WP, Netherlands Phone: 0800-567-8990

# SPRUCE HOLLOW

## Balançoire

### Modèle# 2400351

Veillez garder ce manuel car il contient des informations utiles



**ATTENTION**  
**MONTAGE PAR ADULTE OBLIGATOIRE:**  
Ne convient pas aux enfants de moins de 36 mois en raison des petites pièces.  
**POUR USAGE DOMESTIQUE SEULEMENT. DESTINÉ À L'EXTÉRIEUR.**

CAN ICES-003 (B)/NMB-003(B)



***Veillez visiter [www.backyarddiscovery.com](http://www.backyarddiscovery.com)***

*Pour obtenir le manuel de montage le plus récent, pour enregistrer votre produit ou pour commander des pièces de rechange. Para obtener instrucciones en español, visite [www.backyarddiscovery.com](http://www.backyarddiscovery.com)*



PAS-À-PAS  
INSTRUCTIONS INTERACTIVE EN 3D  
TÉLÉCHARGEZ L'APPLICATION GRATUITEMENT



INS-2400351-A-SPRUCE HOLLOW-FR 11/14/25

## Manuel du propriétaire - Dimensions d'installation de base et notes relatives au montage

Placez la balançoire sur un terrain plat, à au moins 2007 mm [6 pi - 7 po] de toute structure ou obstruction, telle qu'une clôture, un garage, une maison, des branches en surplomb, des cordes à linge ou des fils électriques.

• Pendant le montage de l'unité, prenez le temps, avant et après chaque phase, de vous assurer que le fort est de niveau. Si le fort n'est pas de niveau, le montage sera difficile et il pourrait en résulter un montage incorrect. Des précautions supplémentaires doivent être prises pour vous assurer que les angles du fort soient bien droits.

• L'aire de jeu sécuritaire fait référence à une zone s'étendant sur 2007 mm (6 pi-7 po) au-delà de l'ensemble de jeu, sur tous les côtés, y compris l'espace situé au-dessus de l'ensemble de jeu.

### SCHÉMA DE LA ZONE DE JEU SÉCURITAIRE

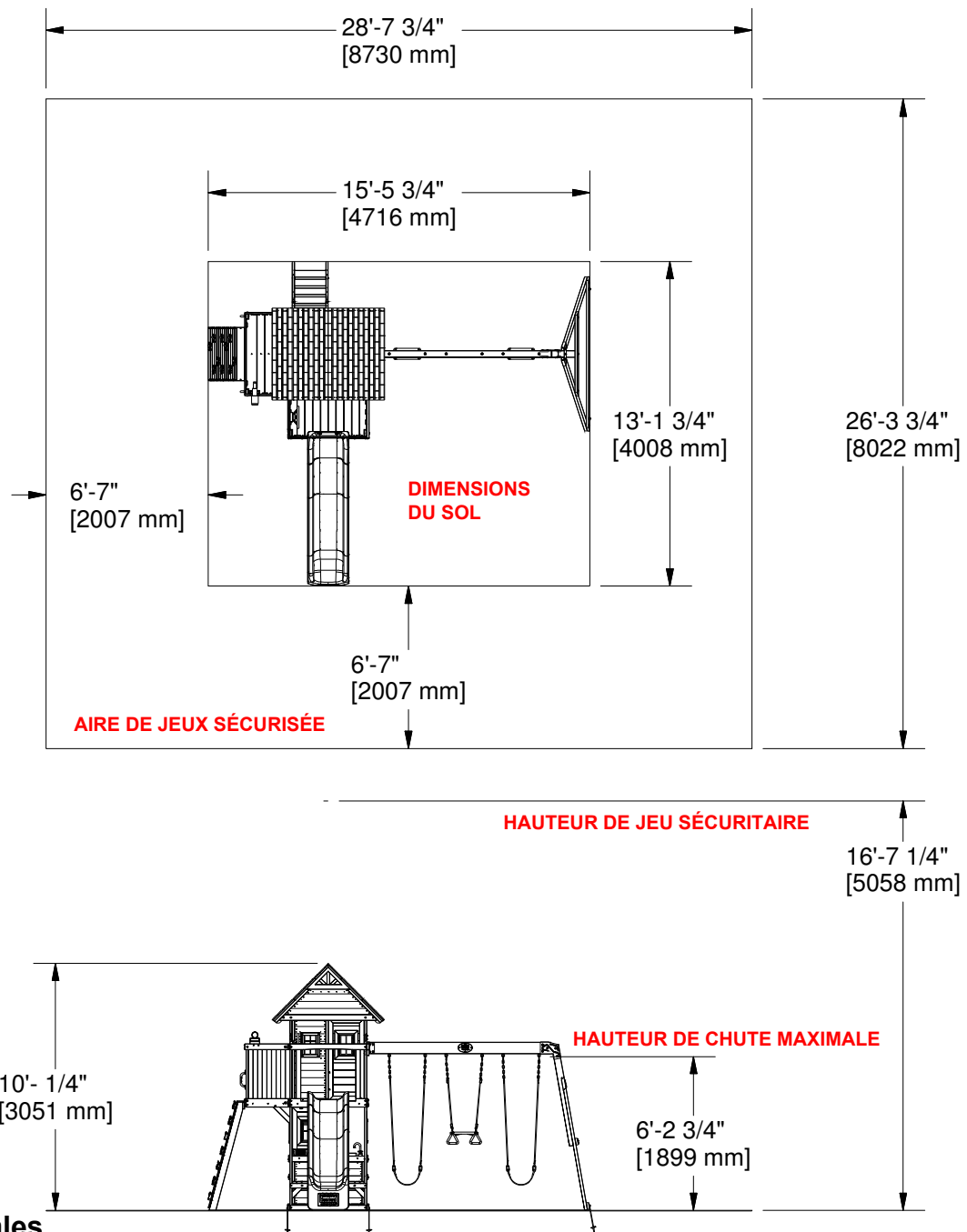

### Informations générales

- Votre ensemble de jeu a été conçu et étudié pour les enfants uniquement et pour un usage résidentiel uniquement.
- Un maximum de 68 kg (150 lb) par enfant est recommandé pour toutes les activités ludiques conçues pour un usage individuel.
- Un maximum de 54 kg (120 lb) par enfant est recommandé pour les activités ludiques conçues pour plusieurs enfants.
- Le nombre maximum d'enfants recommandé pour cette balançoire est de 11.

# MANUEL DE PROPRIÉTAIRE - IDENTIFICATION DES PIÈCES

## PIÈCES EN BOIS (PAS À L'ÉCHELLE)



**EB10 BLOC DE MONTAGE - W4L21007**  
(x2) 1 3/8"x3"x4 3/4" (36x76x120)

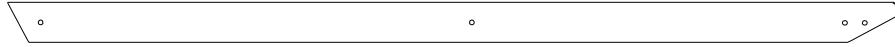

**EG77 SUPPORT À L'ANGLE - W4L21023**  
(x2) 1 3/8"x3 1/4"x74 3/8" (36x84x1890)



**GG71 SUPPORT À POUTRE DE BALANÇOIRE - W4L21021**  
(x1) 3 1/4"x3 1/4"x49 5/8" (84x84x1260)



**GJ74 POUTRE DE BALANÇOIRE LONG - W4L21025**  
(x1) 3 1/4"x5 5/8"x89 1/2" (84x144x2274)



**HB01 PLANCHE DE SOL - W4L19917**  
(x1) 1"x2 7/8"x61 1/2" (24x72x1563)



**HB02 PLANCHE DE SOL - W4L19918**  
(x1) 1"x2 7/8"x37 1/2" (24x72x952)



**HB04 PLANCHE DE SOL - W4L19916**  
(x1) 1"x2 7/8"x61 1/2" (24x72x1563)



**HB07 SUPPORT DE SIÈGE - W4L19930**  
(x1) 1"x2 7/8"x37 1/2" (24x72x952)

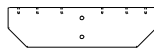

**HG03 SUPPORT DE TABLE - W4L20976**  
(x1) 1"x3 1/4"x12 3/8" (24x84x313)



**HG06 BANQUETTE - W4L20985**  
(x4) 1"x3 1/4"x21 5/8" (24x84x548)



**HG71 BARREAU D'ÉCHELLE - W4L21012**  
(x4) 1"x3 1/4"x16" (24x84x405)



**HJ01 PANNEAU DE TABLE - W4L20986**  
(x1) 1"x5 5/8"x21 5/8" (24x144x548)



**HR02 PLANCHE DE SOL - W4L19919**  
(x1) 1"x2 3/8"x37 1/2" (24x60x952)



**HR07 BLOC DE SUPPORT - W4L20987**  
(x1) 1"x2 3/8"x3 1/4" (24x60x84)

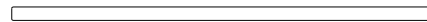

**HC04 PLANCHE DE SUPPORT - W4L21005**  
(x1) 1"x1 1/8"x35 1/8" (24x28x891)



**HG05 BANQUETTE - W4L20983**  
(x2) 1"x3 1/4"x21 5/8" (24x84x548)



**HG70 PLANCHE D'ATTACHEMENT - W4L21013**  
(x1) 1"x3 1/4"x17 1/2" (24x84x445)



**HG75 PLANCHE D'ATTACHEMENT - W4L21020**  
(x1) 1"x3 1/4"x26" (24x84x659)



**HR01 BANQUETTE - W4L20984**  
(x2) 1"x2 3/8"x21 5/8" (24x60x548)

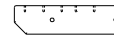

**HR03 SUPPORT DE BANC - W4L20978**  
(x2) 1"x2 3/8"x9" (24x60x230)

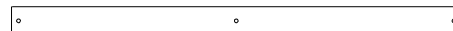

**HR08 PANNEAU DE SOL DU PORCHE - W4L19932**  
(x1) 1"x2 3/8"x37 1/2" (24x60x952)

# MANUEL DE PROPRIÉTAIRE - IDENTIFICATION DES PIÈCES

## PIÈCES EN BOIS (PAS À L'ÉCHELLE)

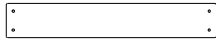

**MB70 SUPPORT ARRIÈRE - W4L21011**  
(x1) 5/8"x2 7/8"x17 1/2" (16x72x445)



**MG05 PLANCHER - W4L20990**  
(x2) 5/8"x3 1/4"x21 1/2" (16x84x547)



**MG06 PLAN DE TRAVAIL - W4L20997**  
(x1) 5/8"x3 1/4"x35 1/8" (16x84x891)



**MG07 PLAN DE TRAVAIL - W4L20998**  
(x1) 5/8"x3 1/4"x35 1/2" (16x84x903)



**MJ01 PLANCHER - W4L20988**  
(x2) 5/8"x5"x21 1/2" (16x126x547)



**MJ10 PLANCHER - W4L21001**  
(x1) 5/8"x5 1/4"x39" (16x133x990)



**MR02 PIQUET - W4L21004**  
(x18) 5/8"x2 3/8"x26" (16x60x660)



**MS04 PLANCHER - W4L20989**  
(x6) 5/8"x3 3/4"x21 1/2" (16x96x547)



**MS08 PLANCHER - W4L20999**  
(x2) 5/8"x3 1/2"x19 3/4" (16x89x503)



**MS09 PLANCHER - W4L21000**  
(x8) 5/8"x3 3/4"x19 3/4" (16x96x503)



**MS11 PLANCHER - W4L21002**  
(x12) 5/8"x3 3/4"x39" (16x96x990)

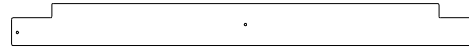

**MS12 PLANCHER - W4L21003**  
(x2) 5/8"x3 1/2"x39" (16x89x990)



**MS20 PANNEAU DE MUR DE ROCHE - W4L21016**  
(x7) 5/8"x3 3/4"x26" (16x96x659)



**MS21 PLANCHE SUPÉRIEURE - W4L21017**  
(x1) 5/8"x3 3/4"x26" (16x96x659)



**MS22 PANNEAU DE MUR DE ROCHE - W4L21018**  
(x3) 5/8"x3 3/4"x26" (16x96x659)



**MS23 PANNEAU DE MUR DE ROCHE - W4L21019**  
(x4) 5/8"x3 3/4"x26" (16x96x659)



**NB01 RAIL DE MUR ARQUÉ - W4L20969**  
(x1) 3/4"x2 7/8"x42" (20x72x1066)



**NB02 RAIL MURAL - W4L20966**  
(x1) 3/4"x2 7/8"x37 1/2" (20x72x952)



**NB03 RAIL MURAL - W4L20973**  
(x2) 3/4"x2 7/8"x47 3/8" (20x72x1202)



**NB04 RAIL MURAL - W4L20967**  
(x1) 3/4"x2 7/8"x23 1/4" (20x72x590)

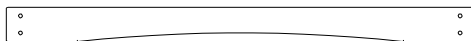

**NB05 RAIL MURAL - W4L20970**  
(x1) 3/4"x2 7/8"x39" (20x72x991)

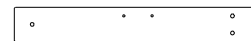

**NB06 RAIL MURAL - W4L20968**  
(x1) 3/4"x2 7/8"x20 5/8" (20x72x524)



**NB12 RAIL MURAL - W4L20971**  
(x2) 3/4"x3 1/4"x39" (20x84x991)

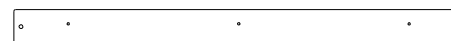

**NB16 RAIL MURAL - W4L20982**  
(x1) 3/4"x2 7/8"x37 1/2" (20x72x952)

# MANUEL DE PROPRIÉTAIRE - IDENTIFICATION DES PIÈCES

## PIÈCES EN BOIS (PAS À L'ÉCHELLE)

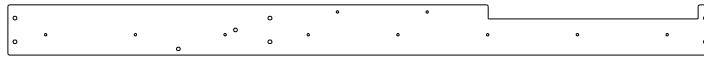

**NJ01 RAIL AU SOL - W4L19924**  
(x1) 3/4"x4 1/8"x58 3/4" (20x106x1492)



**NJ02 RAIL AU SOL - W4L19923**  
(x1) 3/4"x4 1/8"x61 1/4" (20x106x1555)

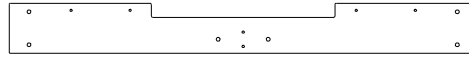

**NJ03 RAIL AU SOL - W4L19926**  
(x1) 3/4"x4 1/8"x39" (20x106x991)



**NJ04 RAIL AU SOL - W4L19925**  
(x1) 3/4"x4 1/8"x58 3/4" (20x106x1492)



**NJ05 RAIL AU SOL - W4L19927**  
(x1) 3/4"x4 1/8"x20 5/8" (20x106x524)

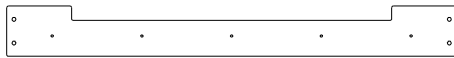

**NJ06 RAIL AU SOL - W4L19928**  
(x1) 3/4"x4 1/8"x37 1/2" (20x106x952)

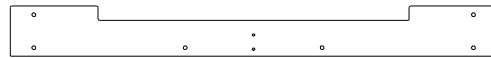

**NJ07 RAIL AU SOL - W4L19935**  
(x1) 3/4"x4 1/8"x40 5/8" (20x106x1031)



**OB02 SUPPORT DE POUTRE PIVOTANTE - W4L20964**  
(x1) 1 1/8"x2 7/8"x59 5/8" (30x72x1515)



**OB04 BALCON MONTANT -W4L19933**  
(x2) 1 1/8"x2 3/8"x30 3/4" (30x60x782)



**OG01 MONTANT ASSEMBLAGE - W2A04237**  
(x1) 1 1/8"x3 1/4"x85 5/8" (30x84x2174)



**OG02 MONTANT - W4L19920**  
(x1) 1 1/8"x3 1/4"x85 5/8" (30x84x2174)

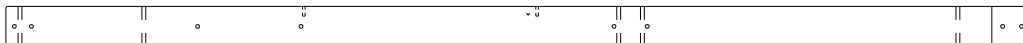

**OG03 MONTANT - W4L19921**  
(x1) 1 1/8"x3 1/4"x85 5/8" (30x84x2174)

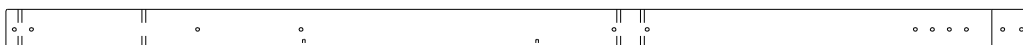

**OG04 MONTANT - W4L19922**  
(x1) 1 1/8"x3 1/4"x85 5/8" (30x84x2174)

# MANUEL DE PROPRIÉTAIRE - IDENTIFICATION DES PIÈCES

## PIÈCES EN BOIS (PAS À L'ÉCHELLE)



**OG05 MONTANT - W4L21027**  
(x1) 1 1/8"x3 1/4"x80 3/4" (30x84x2052)



**OG06 MONTANT - W4L19929**  
(x1) 1 1/8"x3 1/4"x80 3/4" (30x84x2052)

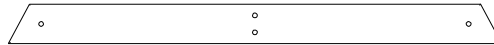

**OG07 SUPPORT D'EXTRÉMITÉ - W4L21024**  
(x1) 1"x3 1/2"x41" (30x84x1045)



**OG08 PLANCHE DE SOL - W4L21022**  
(x1) 1 1/8"x3 1/4"x75" (30x84x1905)



**OG09 MONTANT - W4L20961**  
(x4) 1 1/8"x3 1/4"x12 3/4" (30x84x325)



**OG12 SUPPORT DE TABLE - W4L20975**  
(x1) 1 1/8"x3 1/4"x22 3/8" (30x84x567)



**OG13 RAIL GAUCHE - W4L21014**  
(x1) 1 1/8"x3 1/4"x54 3/4" (30x84x1392)



**OG14 RAIL DROIT - W4L21015**  
(x1) 1 1/8"x3 1/4"x54 3/4" (30x84x1392)



**OG15 MONTANT GAUCHE - W4L21009**  
(x1) 1 1/8"x3 1/4"x58" (30x84x1474)



**OG16 DROIT MONTANT - W4L21010**  
(x1) 1"x3 3/8"x58" (30x84x1474)



**OO04 SUPPORT DE TABLE - W4L20977**  
(x1) 1 1/8"x1 1/8"x12 3/8" (30x30x313)



**OR01 SUPPORT AU TERRASSE EN BOIS - W4L21008**  
(x4) 1 1/8"x2 3/8"x13 1/8" (30x60x332)



**OR02 SOLIVE DE PLANCHER - W4L20994**  
(x1) 1 1/8"x2 3/8"x37 1/2" (30x60x952)



**OR05 SOLIVE DE PLANCHER - W4L20995**  
(x1) 1 1/8"x2 3/8"x20 1/2" (30x60x520)



**OR07 SUPPORT À L'ANGLE - W4L20979**  
(x2) 1 1/8"x2 3/8"x10" (30x60x254)



**OR08 BLOC DE SUPPORT - W4L20996**  
(x1) 1 1/8"x2 3/8"x5 3/4" (30x60x145)



**OR09 BLOC DE SUPPORT - W4L21006**  
(x1) 1 1/8"x2 3/8"x5 3/4" (30x60x145)



**OS01 SUPPORT DE POUTRE PIVOTANTE - W4L20965**  
(x1) 1 1/8"x3 3/4"x60 3/8" (30x96x1535)

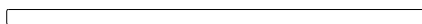

**PP01 PLANCHE DE SUPPORT - W4L20991**  
(x3) 1 1/4"x1 1/4"x35 1/8" (32x32x891)



**PP02 PLANCHE DE SUPPORT - W4L20993**  
(x2) 1 1/4"x1 1/4"x19 1/4" (32x32x489)



**PP03 PLANCHE DE SUPPORT - W4L20992**  
(x1) 1 1/4"x1 1/4"x35" (32x32x890)

# MANUEL DE PROPRIÉTAIRE - IDENTIFICATION DES PIÈCES

## PIÈCES EN BOIS (PAS À L'ÉCHELLE)

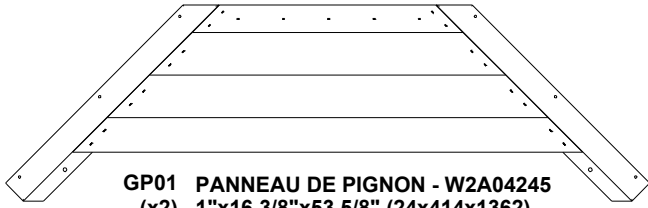

**GP01 PANNEAU DE PIGNON - W2A04245**  
(x2) 1"x16 3/8"x53 5/8" (24x414x1362)

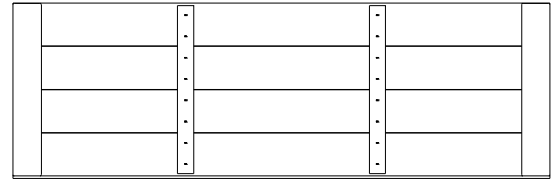

**RP01 PANNEAU DE TOIT - W2A04246**  
(x4) 1 3/8"x19 3/8"x46 3/4" (35x370x1137)

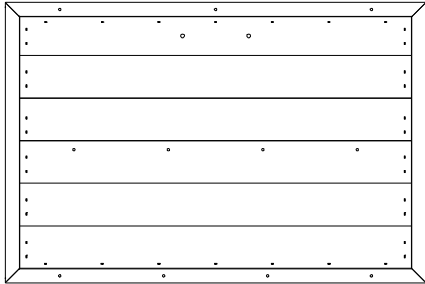

**WP01 PANNEAU MURAL - W2A04238**  
(x1) 1"x20 3/8"x37 3/4" (24x593x891)

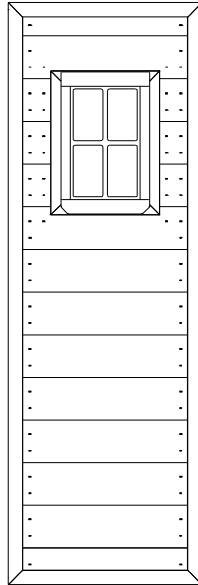

**WP02 PANNEAU MURAL - W2A04239**  
(x4) 1 5/8"x18 3/4"x40" (36x410x1230)

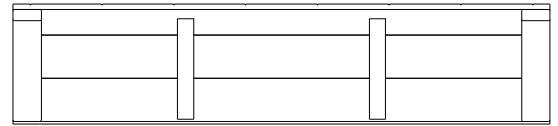

**RP02 PANNEAU DE TOIT - W2A04247**  
(x2) 1 3/8"x10"x44 3/4" (35x253x1137)

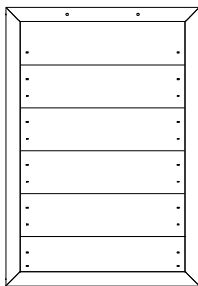

**WP04 PANNEAU MURAL - W2A04242**  
(x2) 1"x16 1/8"x23 1/4" (24x410x589)

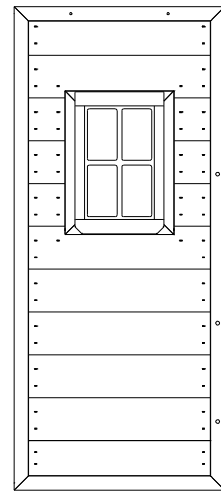

**WP03 PANNEAU MURAL - W2A04241**  
(x1) 1 3/8"x17 1/2"x40 1/4" (36x446x1022)

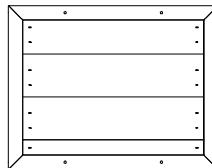

**WP06 PANNEAU MURAL - W2A04244**  
(x1) 1"x11 3/8"x17 1/2" (24x346x444)

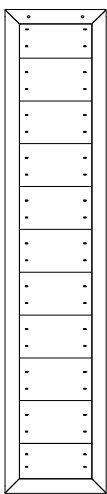

**WP05 PANNEAU MURAL - W2A04243**  
(x2) 1"x8 3/8"x39 1/8" (24x214x1022)

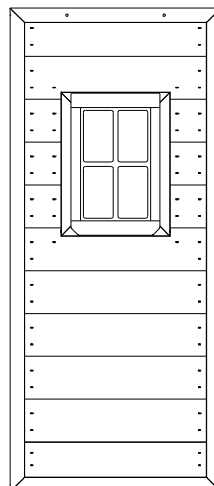

**WP08 PANNEAU MURAL - W2A04248**  
(x1) 1 5/8"x18 3/4"x40" (36x446x1022)

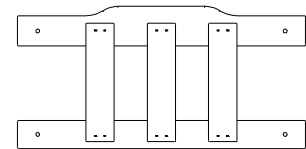

**WP07 DOSSIER DE BANC - W2A04240**  
(x2) 1 1/8"x11 7/8"x24 1/4" (28x301x610)

# MANUEL DE PROPRIÉTAIRE - IDENTIFICATION DES PIÈCES

## COMPONENTS DE QUINCAILLERIE

(PAS À L'ÉCHELLE)

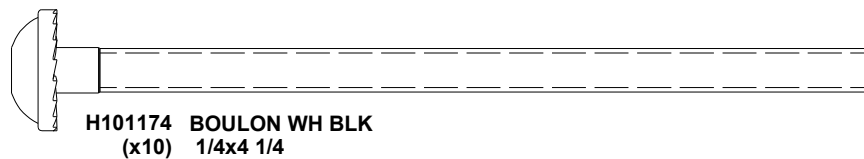
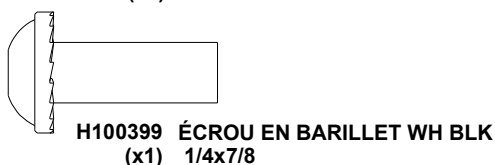
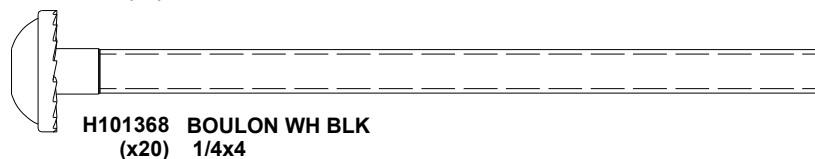
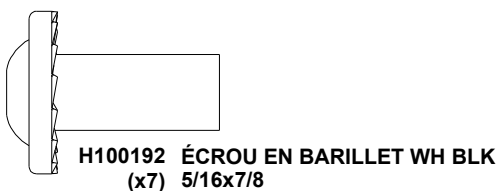
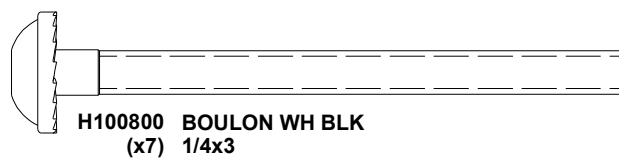
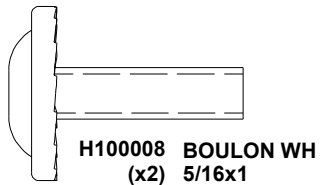
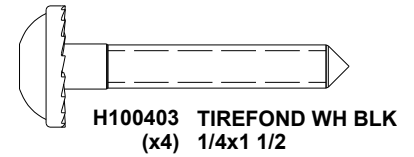
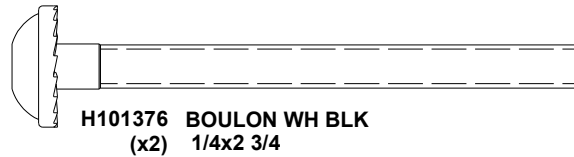
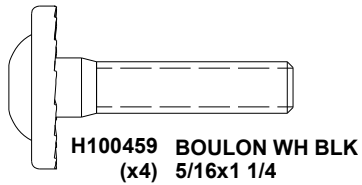
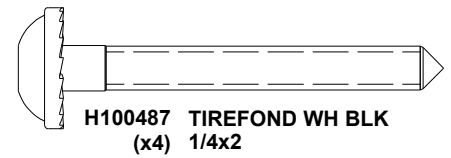
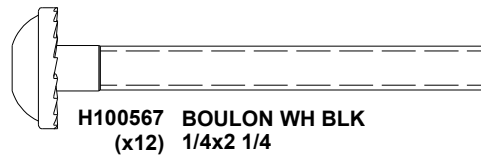
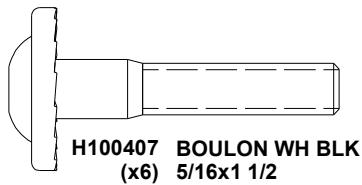
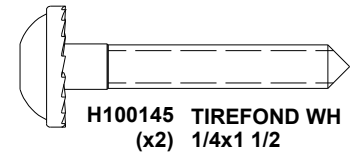
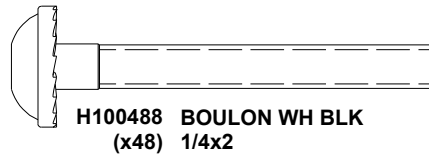
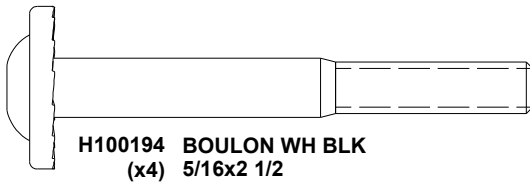
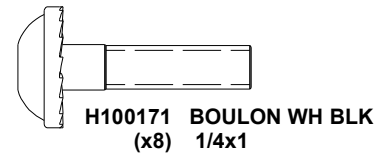
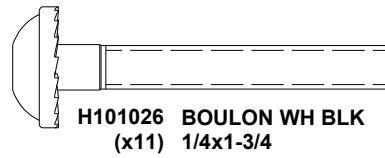
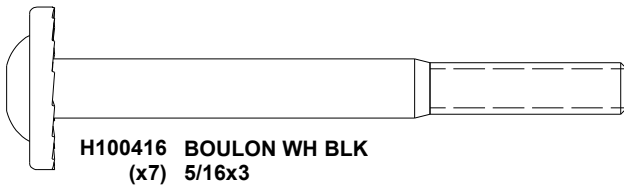
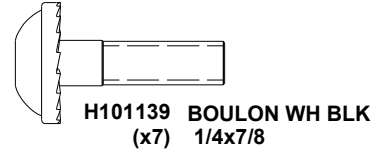
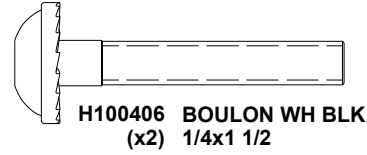
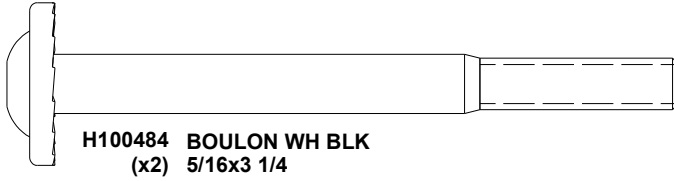
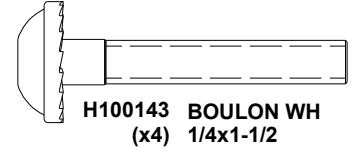
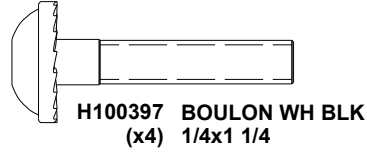
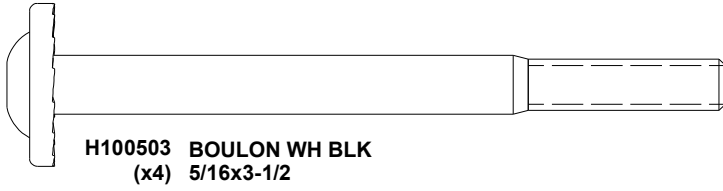
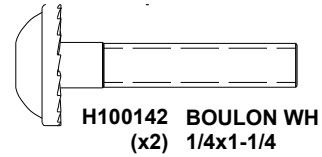

# MANUEL DE PROPRIÉTAIRE - IDENTIFICATION DES PIÈCES

## COMPONENTS DE QUINCAILLERIE (PAS À L'ÉCHELLE)



H100498 BOULON HEX - BLK  
(x4) 5/16x1 1/2

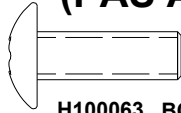

H100063 BOULON PTH  
(x20) 1/4x3/4

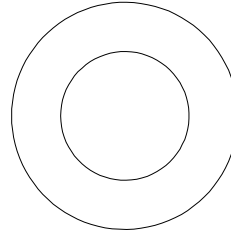

H100103 RONDELLE DE SÉCURITÉ  
(x6) 17x30

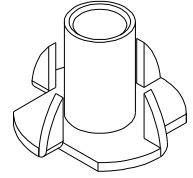

H100379 ÉCROU EN T BLK  
(x26) 5/16

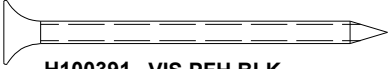

H100391 VIS PFH BLK  
(x42) 8x2

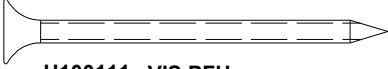

H100111 VIS PFH  
(x34) 8x2

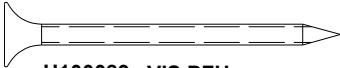

H100089 VIS PFH  
(x12) 8x1 3/4

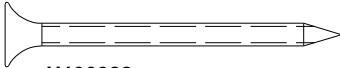

H100382 VIS PFH BLK  
(x37) 8x1 3/4

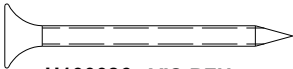

H100086 VIS PFH  
(x215) 8x1 1/2

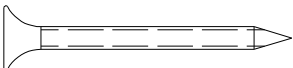

H100200 VIS PFH BLK  
(x36) 8x1 1/2

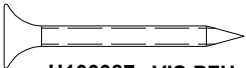

H100087 VIS PFH  
(x2) 8x1 1/4

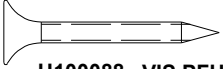

H100088 VIS PFH  
(x80) 8x1 1/8

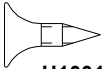

H100124 VIS PFH  
(x4) 8 x 1/2



H100202 VIS PWH BLK  
(x36) 8x5/8

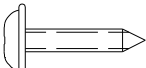

H100128 VIS PWH  
(x22) 8x5/8

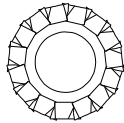

H100138 RONDELLE D'ARRET EXT  
(x8) 6x15

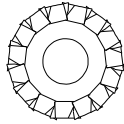

H100405 RONDELLE D'ARRET EXT BLK  
(x132) 6x15

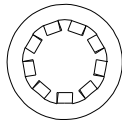

H100108 RONDELLE D'ARRET INT  
(x20) 8x15

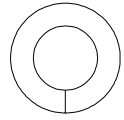

H100477 RONDELLE FENDUE BLK  
(x4) 5/16

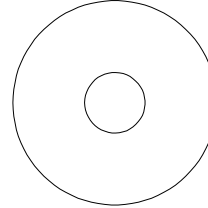

H100478 RONDELLE PLATE BLK  
(x4) 8x27

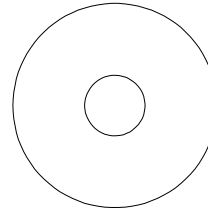

H100105 RONDELLE PLATE  
(x6) 8x27

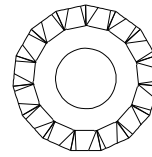

H100198 RONDELLE D'ARRET EXT BLK  
(x6) 8x19

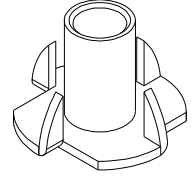

H100074 ÉCROU EN T  
(x2) 5/16

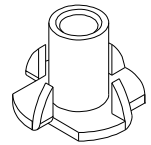

H100398 ÉCROU EN T BLK  
(x130) 1/4

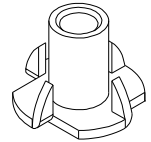

H100072 ÉCROU EN T  
(x26) 1/4

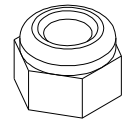

H100110 ECROU VERROU  
(x6) 5/16

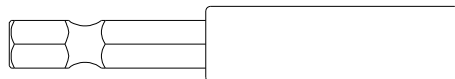

H100100 MANDRIN MAGNÉTIQUE  
(x1)

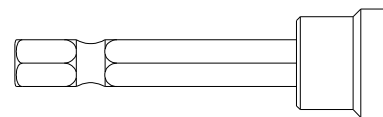

H100764 NIVEAU DE VIS  
(x1)



H100147 TORX BIT  
(x1) T-30

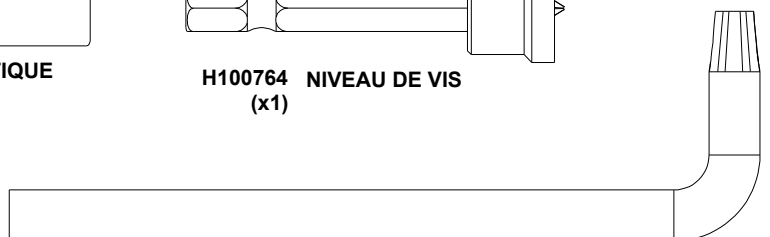

H100114 CLÉ TORX  
(x1) T-30

# MANUEL DE PROPRIÉTAIRE - IDENTIFICATION DES PIÈCES

## COMPONENTS ACCESSOIRES (PAS À L'ÉCHELLE)

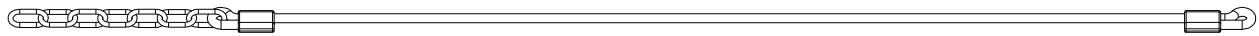

**A100087 CHAÎNE À CORDE**  
(x4) VERT 51.25"



**A100083 CHAÎNE À CORDE**  
(x2) VERT 33"



**A4M02894 PORTE- BALANÇOIRE QUICK LINK**  
(x6)



**A6P00054 SIÈGE À BALANÇOIRE 22" VERTE**  
(x2)

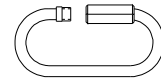

**A100069 QUICK LINK**  
(x6)

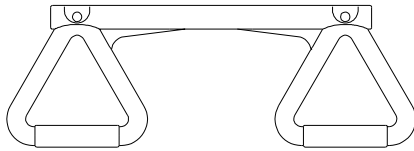

**A6P00034 TRAPÈZE JAUNE**  
(x1)

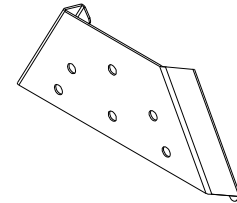

**A4M01169 SUPPORT DE CADRE A**  
(x1)

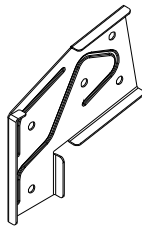

**A4M02890 POUTRE DE BALANÇOIR- GAUCHE**  
(x1)

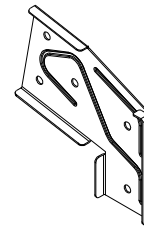

**A4M02891 POUTRE DE BALANÇOIR- DROIT**  
(x1)

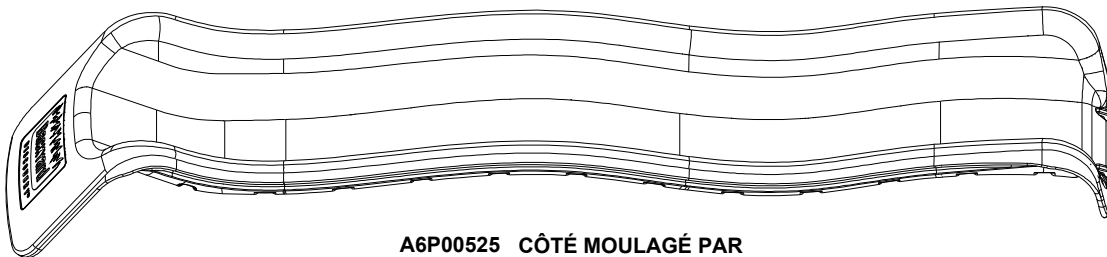

**A6P00525 CÔTÉ MOULAGÉ PAR SOUFLAGE - VERTE**  
(x1)



**A100134 POIGNÉE VERTE**  
(x2) 816 C/C

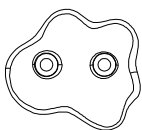

**A6P00038 PIERRE ROUGE**  
(x2) HC #1

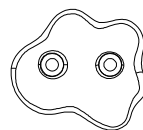

**A6P00042 PIERRE JAUNE**  
(x2) HC #1

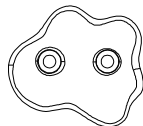

**A6P00040 PIERRE BLEUE**  
(x3) HC #1

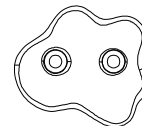

**A6P00036 PIERRE VERTE HC**  
(x3) #1

# MANUEL DE PROPRIÉTAIRE - IDENTIFICATION DES PIÈCES

## COMPONENTS ACCESSOIRES (PAS À L'ÉCHELLE)

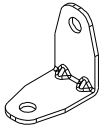

**A4M04303 SUPPORT EN L**  
(x4) 2.5x38x38x49



**A100164 ÉTIQUETTE LOGO BYD LARGE**  
(x1)

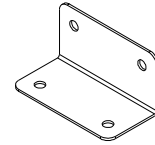

**A100140 SUPPORT EN L**  
(x2) 66x66x127

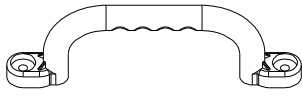

**A6P00303 POIGNÉE JAUNE**  
(x4)

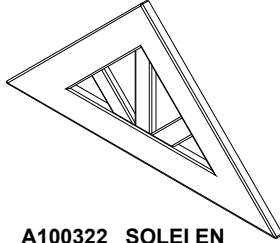

**A100322 SOLEI EN**  
(x2) PLASTIQUE



**A100178 PIQUET FOREUSE**  
(x6)

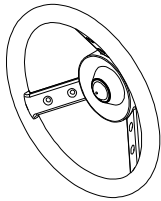

**A100107 VOLANT**  
(x1)

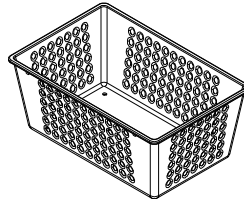

**A6P00069**  
(x1) KIT PANIER DE FRUITS

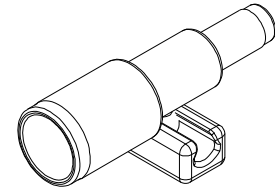

**A6P00096 TÉLESCOPE**  
(x1)

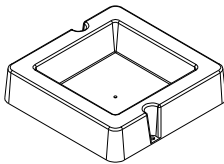

**A6P00032 MONTAGE DE ÉVIER**  
(x1)

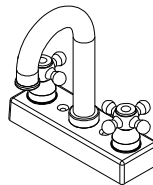

**A6P00024 MONTAGE DE ROBINET**  
(x1)

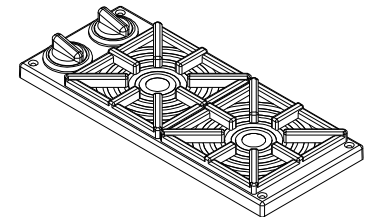

**A6P00025 MONTAGE DE CUISINIÈRE**  
(x1)



**A6P00336 CASSEROLE**  
(x1)



**A6P00338 POÊLE**  
(x1)



**A6P00337 COUVERCLE**  
(x2)



**A6P00410 AIDE-PIQUET**  
(x1)



**A6P00339 SPATULE**  
(x1)

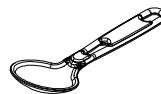

**A6P00340 LOUCHE**  
(x1)

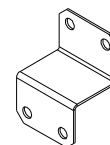

**A4M04561 SUPPORT**  
(x8)

# PRÉ-ASSEMBLAGE ÉTAPE 1 - TRI DES PIÈCES

Il est essentiel pour faciliter l'assemblage que vous preniez le temps de trier et d'organiser les pièces et le matériel.

---

## PIÈCES DE BOIS :

- Organiser les pièces de bois selon le numéro alphanumérique à trois chiffres estampillé sur chaque panneau (p. ex., P01).
- S'il y a plusieurs planches avec le même numéro estampillé, empilez ces pièces ensemble.
- Les timbres se trouvent sur la surface plane des planches ou à l'extrémité des planches.
- Laissez-vous beaucoup de place - les morceaux de bois peuvent prendre beaucoup de place.

**REMARQUE : LES CARTONS NE SONT PAS CLASSÉS PAR NUMÉRO DE PIÈCE.**

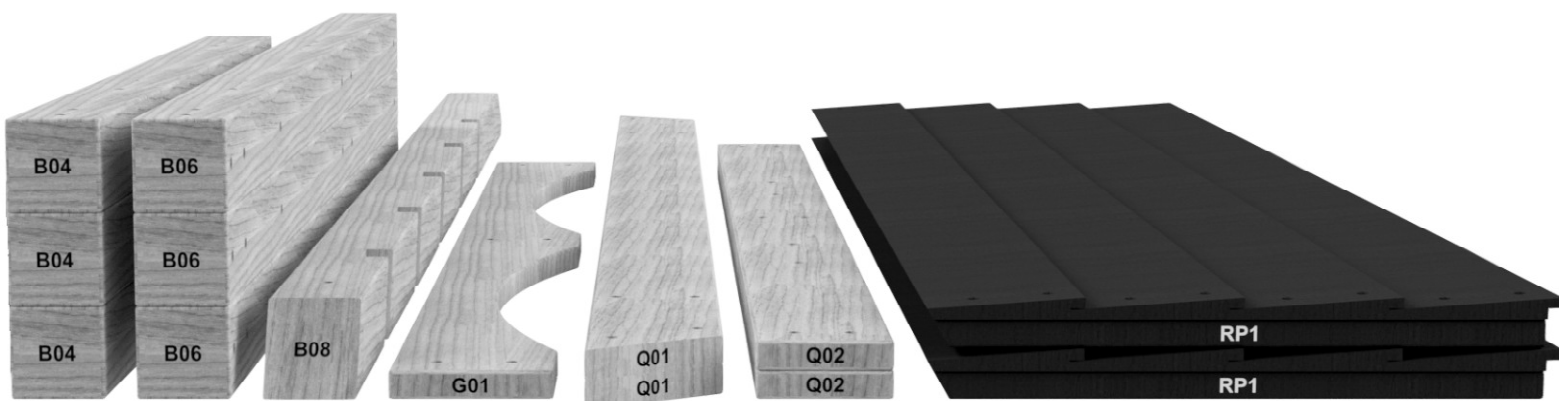

## PIÈCES DE QUINCAILLERIE :

- Nous vous recommandons d'avoir un tableau séparé pour organiser le matériel.
- Les sacs de quincaillerie sont imprimés avec un numéro de pièce alphanumérique à sept chiffres.
- Vous pouvez organiser votre matériel par numéro de pièce ou groupe par type de matériel (boulons, écrous, etc.).
- Pendant l'assemblage, il suffit de faire référence aux quatre derniers chiffres du numéro.

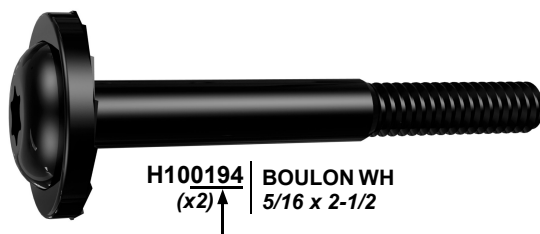

# PRÉ-ASSEMBLAGE ÉTAPE 2 - OUTILS NÉCESSAIRES



PERCEUSE SANS  
FIL OU  
PERCEUSE  
ÉLECTRIQUE



ACCESSOIRES DE LA  
PERCEUSE : MÈCHE  
CRUCIFORME



FORETS DE 1/8 PO, 3/16  
PO, 3/8 PO ET 7/16 PO



TOURNEVIS CRUCIFORM

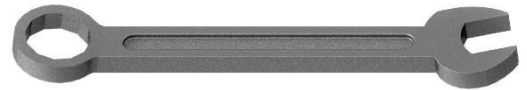

CLÉS OUVERTES DE  
1/2 PO ET 9/16 PO



CLÉ À CLIQUET DE 3/8 PO,  
DOUILLES STANDARD DE 1/2 PO  
ET 7/16 PO, DOUILLES  
PROFONDES DE 1/2 PO ET 7/16 PO



MARTEAU À PANNE FENDUE

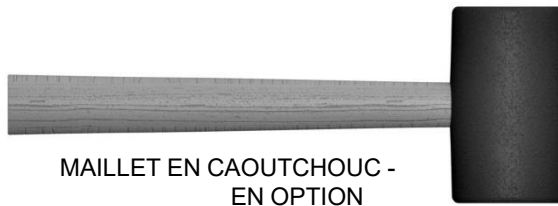

MAILLET EN CAOUTCHOUC -  
EN OPTION

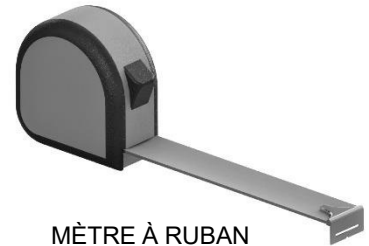

MÈTRE À RUBAN

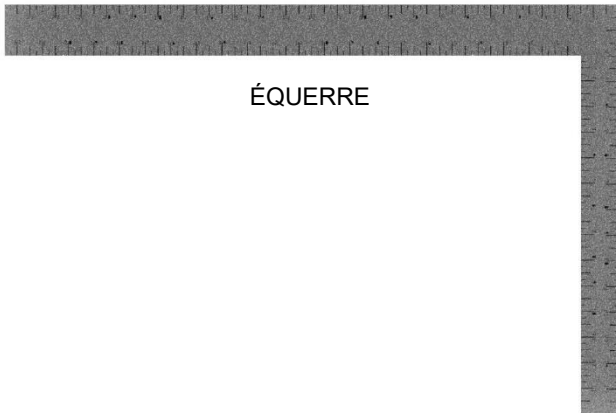

ÉQUERRE



NIVEAU DE 24 PO

# PRÉ-ASSEMBLAGE ÉTAPE 3 - CHOISISSEZ VOTRE MÉTHODE D'ASSEMBLAGE

Plusieurs types d'instructions de montage vous sont proposés.

1. Manuel d'assemblage imprimé inclus avec votre produit
2. Application BILT - Instructions interactives en 3D (en Anglais)
3. Combinaison du manuel imprimé et de l'application BILT (remarque : les numéros d'étape peuvent différer entre les deux méthodes)



**Scannez pour des instructions 3D faciles**

Téléchargez l'application BILT avant de commencer



The image shows a smartphone screen displaying the BILT app interface. The screen features a 3D assembly diagram of a metal frame with a horizontal beam and several hanging components. The interface includes a 'Hardware Needed' button at the top left, a close button (X) at the top right, a menu button (three dots) and a volume icon below it, and navigation buttons (back, play/pause, forward) at the bottom. A step number '17' is visible in the bottom left corner of the app view.

# ÉTAPE 1 - ÉCHELLE

QTÉ	N° DE PIECE	DESCRIPTION
8	H100391	VIS PFH 8x2 BLK



**HG71 BARREAU D'ÉCHELLE - W4L21012**  
(x4) 1"x3 1/4"x16" (24x84x405)



**OG15 MONTANT GAUCHE - W4L21009**  
(x1) 1 1/8"x3 1/4"x58" (30x84x1474)

## ALIGNEZ LES TROUS PILOTES

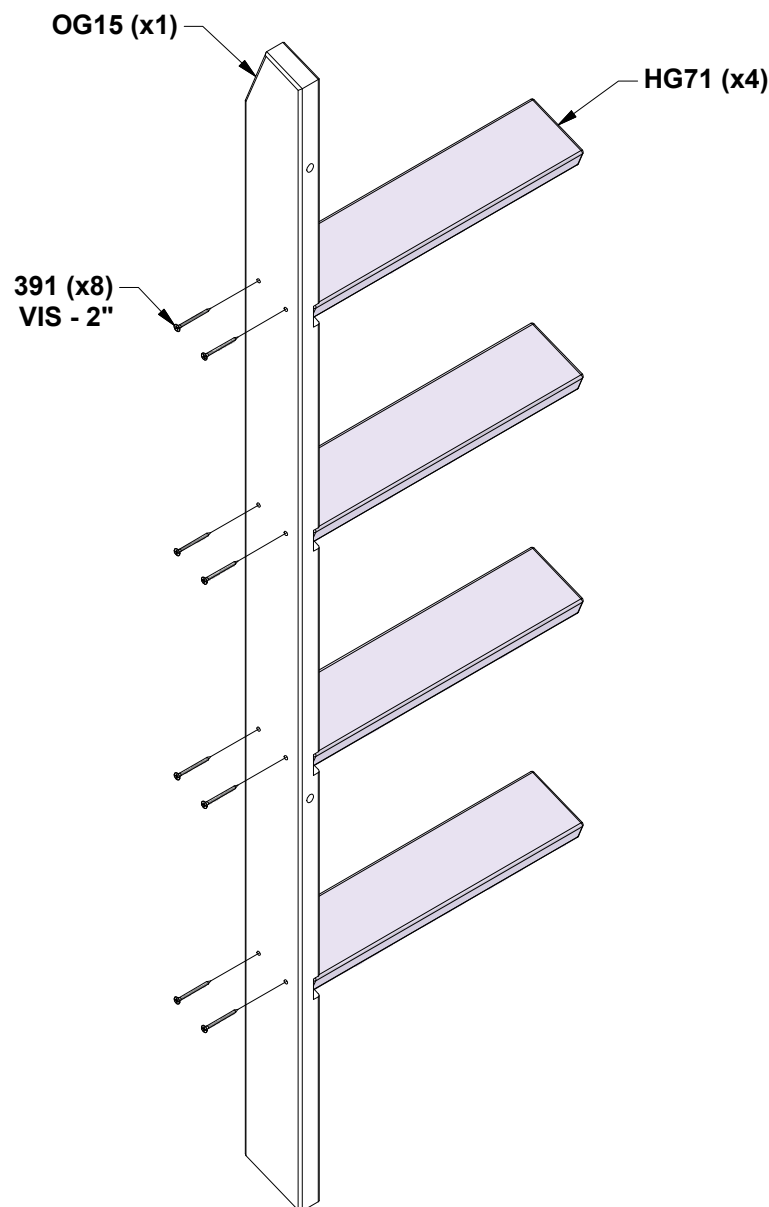

## ÉTAPE 2 - ÉCHELLE

QTÉ	N° DE PIECE	DESCRIPTION
8	H100391	VIS PFH 8x2 BLK

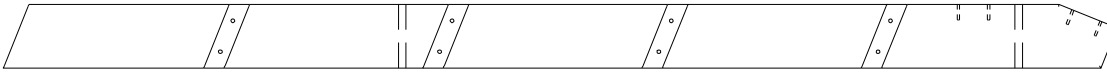

**OG16 MONTANT DROIT -W4L21010**  
(x1) 1"x3 3/8"x58" (30x84x1474)

**ALIGNEZ LES TROUS PILOTES**

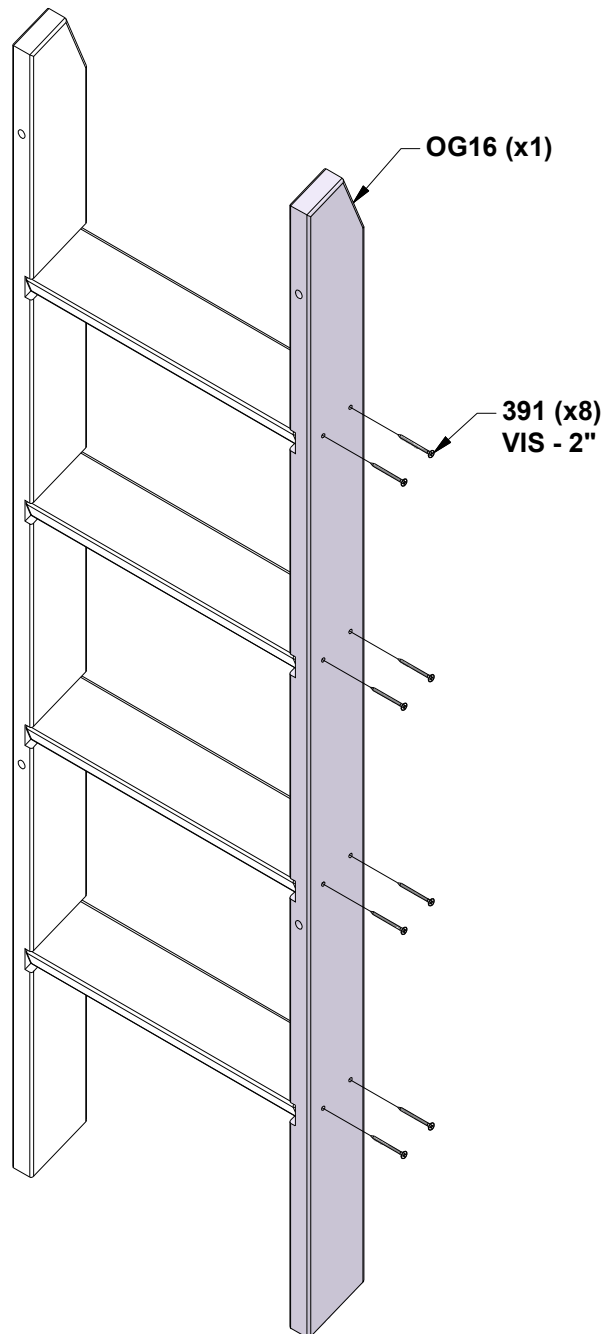

# ÉTAPE 3 - ÉCHELLE

QTÉ	N° DE PIECE	DESCRIPTION
4	H100391	VIS PFH 8x2 BLK



**MB70 SUPPORT ARRIÈRE - W4L21011**  
(x1) 5/8"x2 7/8"x17 1/2" (16x72x445)

**ALIGNEZ LES TROUS PILOTES**

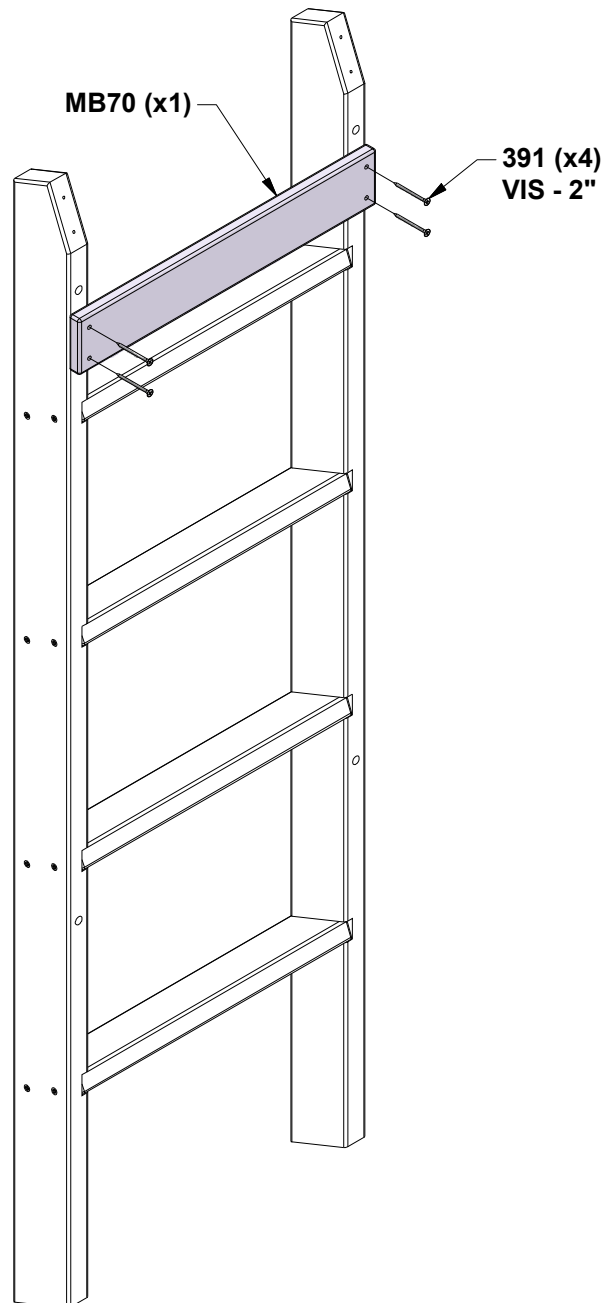

# ÉTAPE 4 - ÉCHELLE

QTÉ	N° DE PIECE	DESCRIPTION
4	H100391	VIS PFH 8x2 BLK



HG70 PLANCHE D'ATTACHEMENT - W4L21013  
(x1) 1"x3 1/4"x17 1/2" (24x84x445)

## ALIGNER LES TROUS PILOTES

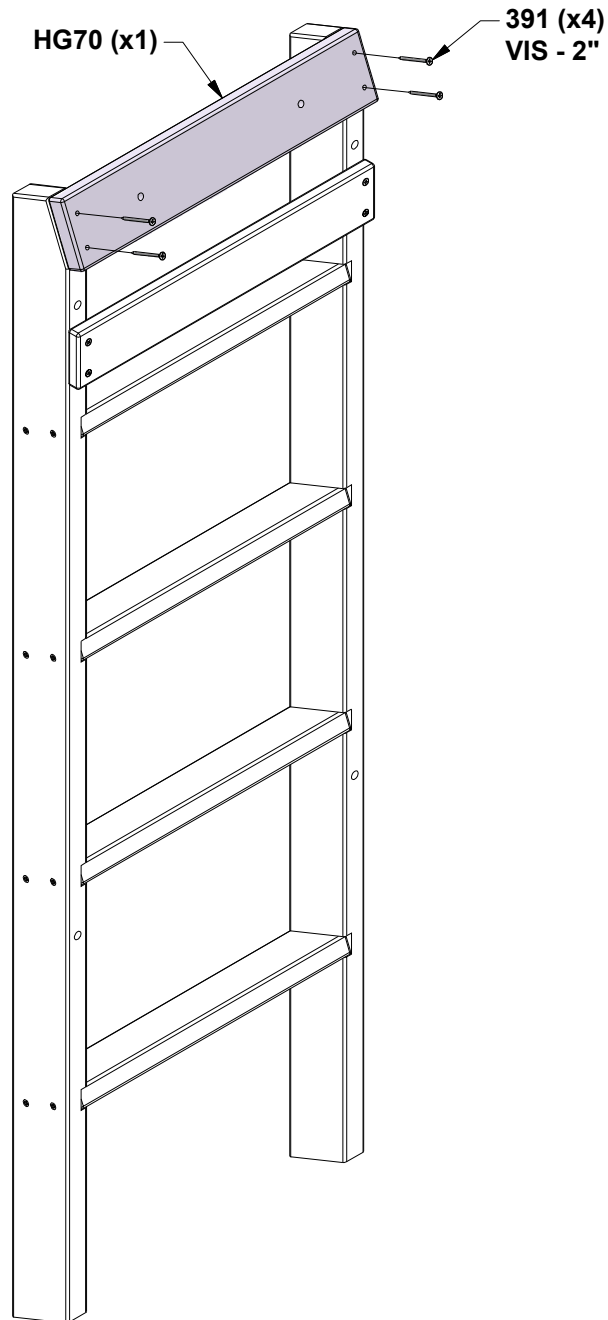

# ÉTAPE 5 - ÉCHELLE

QTÉ	N° DE PIECE	DESCRIPTION
4	H100379	ÉCROU EN T 5/16 BLK
4	H100503	BOULON WH 5/16x3-1/2 BLK

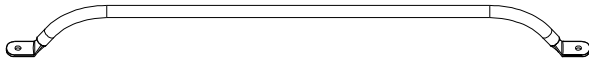

A100134 POIGNÉE VERTE 816 C/C  
(x2)

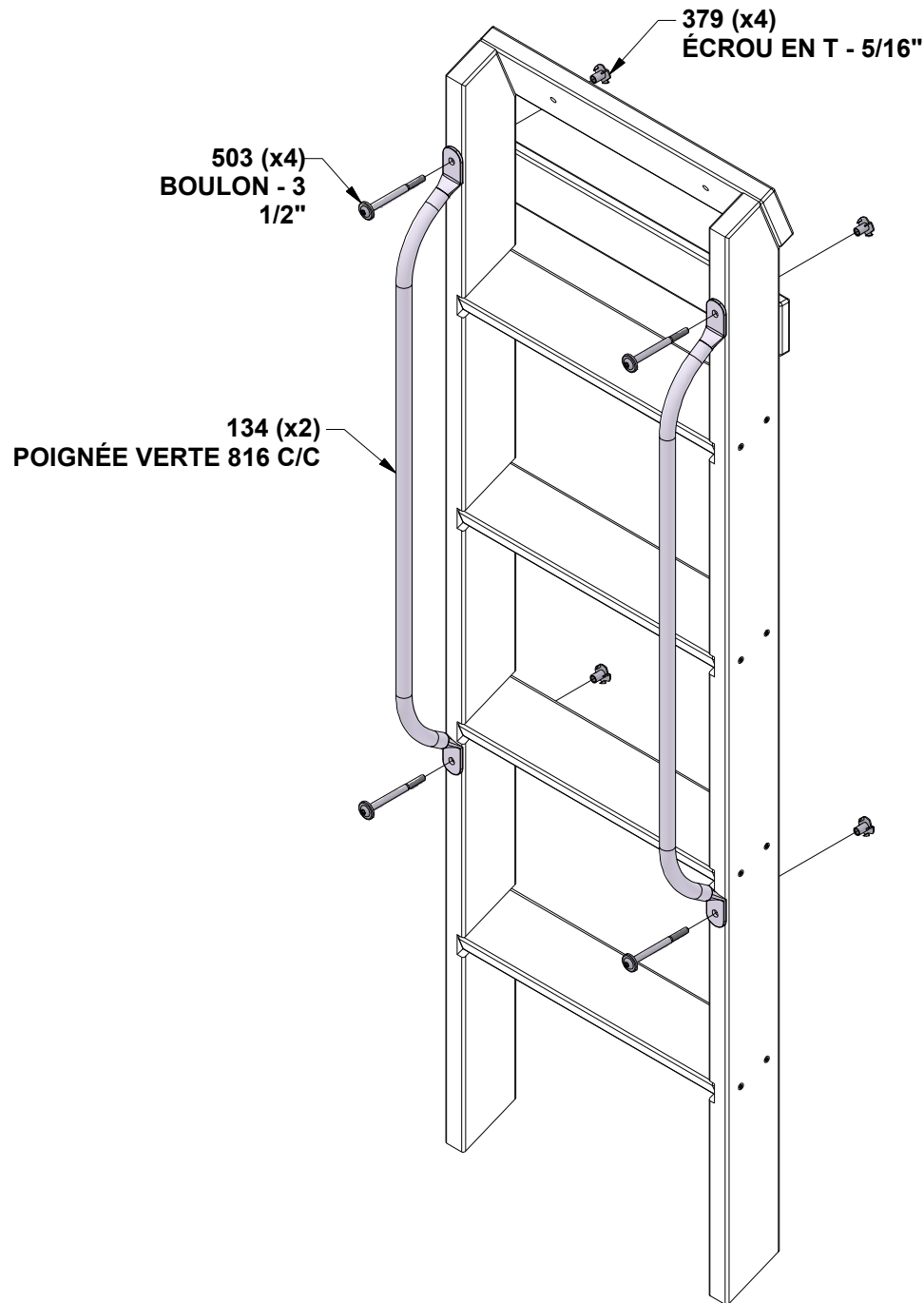

# ÉTAPE 1 - MUR D'ESCALADE

QTÉ	N° DE PIÈCE	DESCRIPTION
20	H100063	BOULON WH 1/4x3/4
20	H100072	ÉCROU EN T 1/4
20	H100108	RONDELLE D'ARRÊT INT 8x15



**MS22 PANNEAU DE MUR DE ROCHE - W4L21018**  
(x3) 5/8"x3 3/4"x26" (16x96x659)

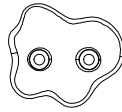

**A6P00036 PIERRE VERTE HC**  
(x3) #1



**MS23 PANNEAU DE MUR DE ROCHE - W4L21019**  
(x4) 5/8"x3 3/4"x26" (16x96x659)

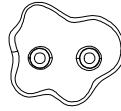

**A6P00042 PIERRE JAUNE**  
(x2) #1

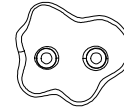

**A6P00040 PIERRE BLEUE #1**  
(x3)

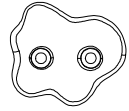

**A6P00038 PIERRE ROUGE**  
(x2) #1

**INSTALLEZ LES ÉCROUS EN T DANS LE BOIS TOUT D'ABORD**

**INSTALLER AVEC DES POIGNÉES POUR LES DOIGTS VERS LE HAUT. \*\*PLACER LES ROCHES COMME DÉSIRÉ\*\***

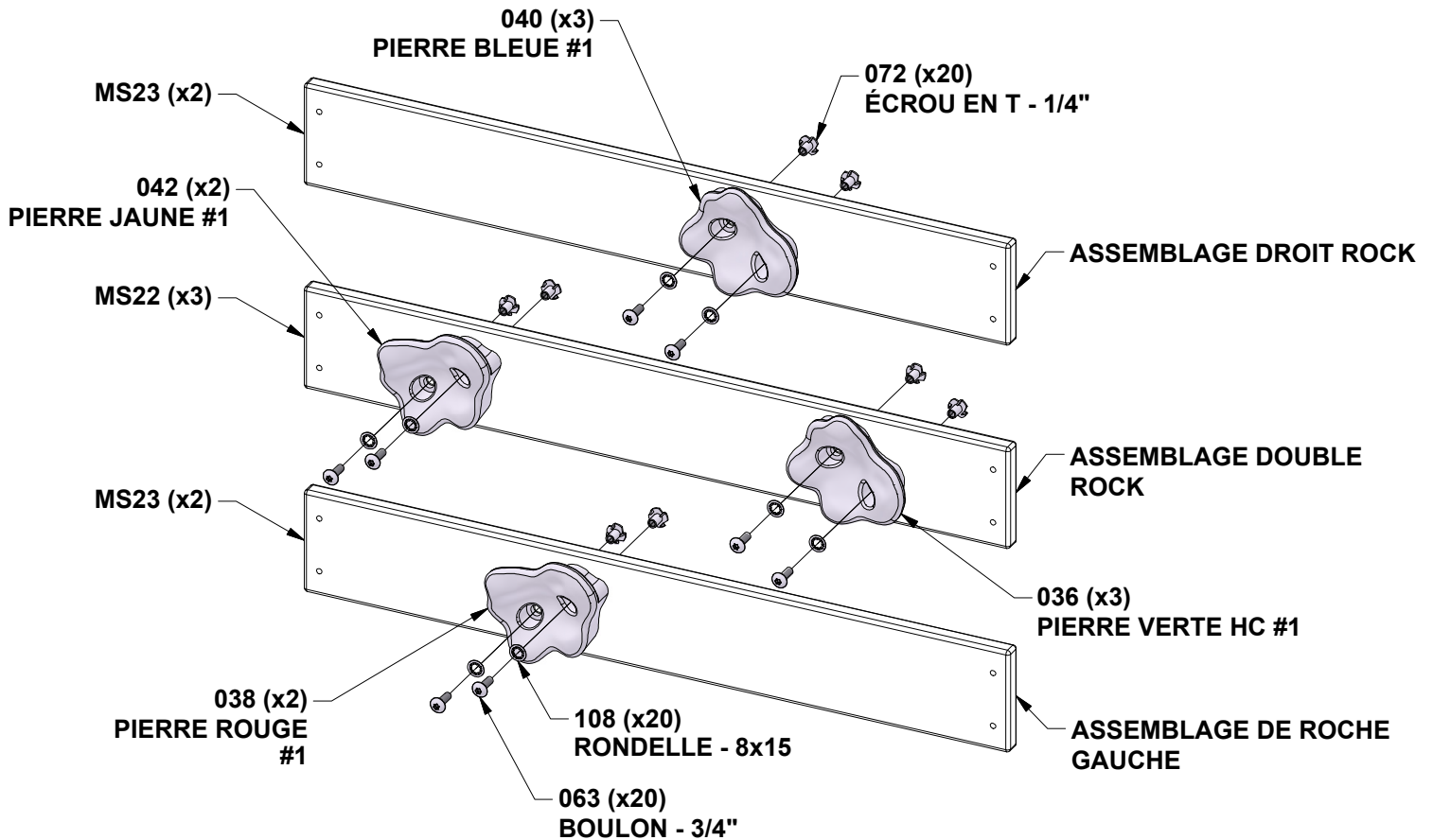
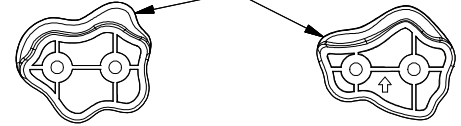

# ÉTAPE 2 - MUR D'ESCALADE

QTÉ	N° DE PIÈCE	DESCRIPTION
56	H100086	VIS PFH 8x1-1/2

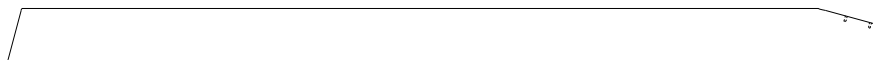
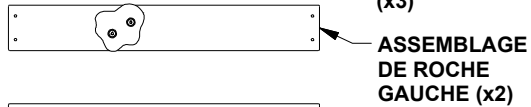
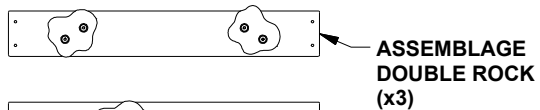
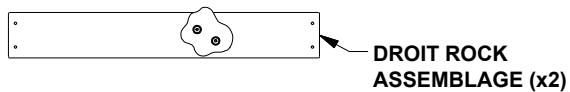

MS20 PANNEAU DE MUR DE ROCHE - W4L21016  
(x7) 5/8"x3 3/4"x26" (16x96x659)

OG14 RAIL DROIT - W4L21015  
(x1) 1 1/8"x3 1/4"x54 3/4" (30x84x1392)

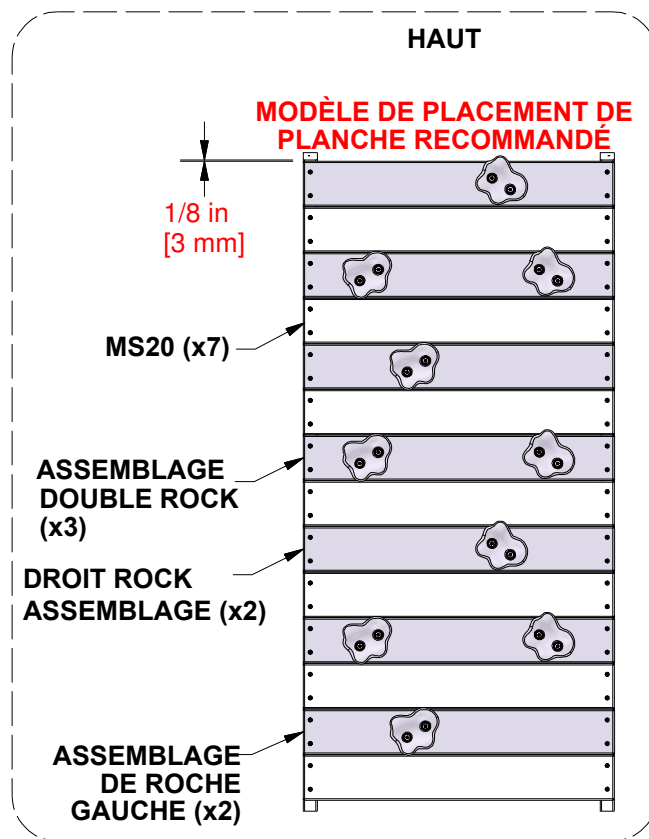
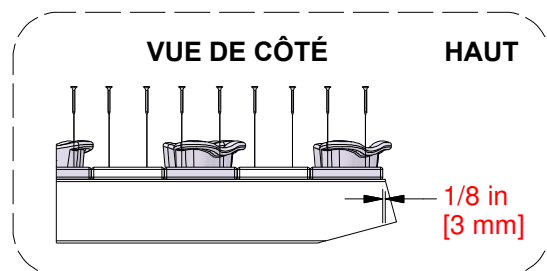
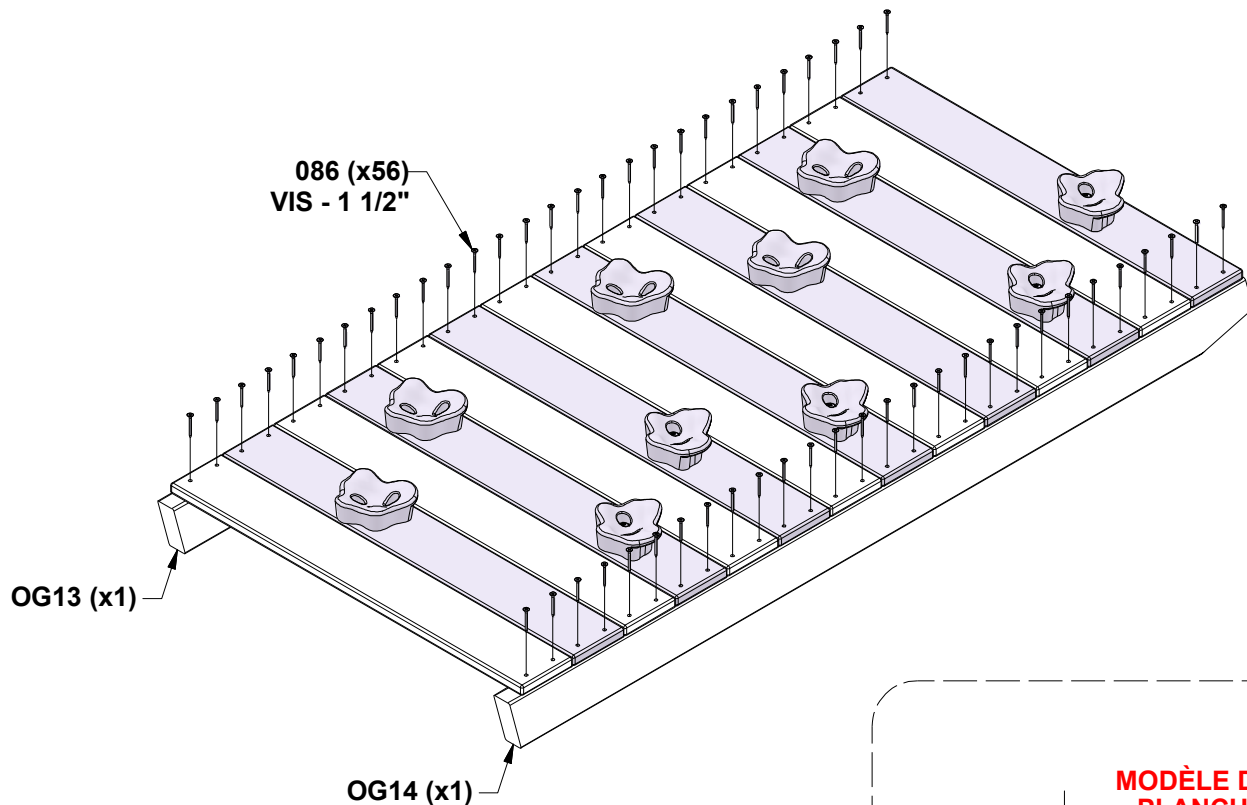

# ÉTAPE 3 - MUR D'ESCALADE

QTÉ	N° DE PIECE	DESCRIPTION
2	H100200	VIS PFH 8x1-1/2 BLK



MS21 PLANCHE SUPÉRIEURE - W4L21017  
(x1) 5/8"x3 3/4"x26" (16x96x659)

**ALIGNER LES TROUS PILOTES**

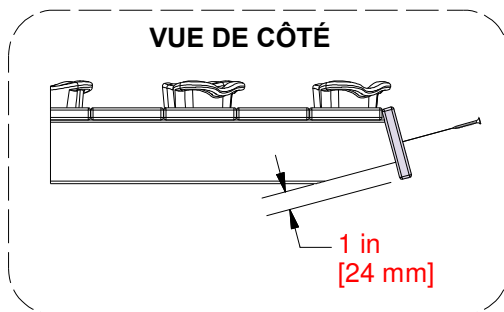
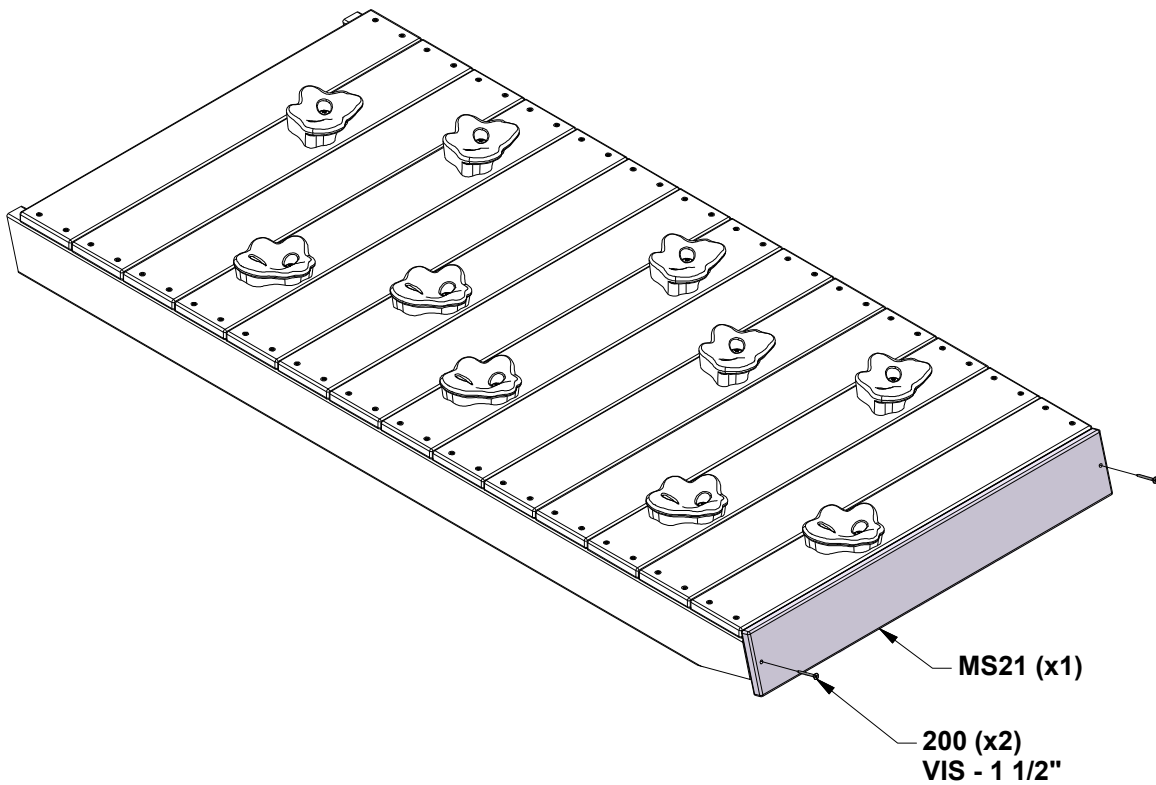

# ÉTAPE 4 - MUR D'ESCALADE

QTÉ	N° DE PIÈCE	DESCRIPTION
4	H100391	VIS PFH 8x2 BLK
2	H100398	ÉCROU EN T 1/4 BLK

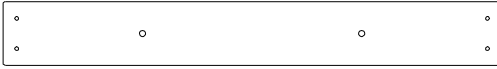

HG75 PLANCHE D'ATTACHEMENT - W4L21020  
(x1) 1"x3 1/4"x26" (24x84x659)

**INSTALLEZ LES ÉCROUS EN T DANS LE BOIS TOUT D'ABORD  
ALIGNÉZ LES TROUS PILOTES**

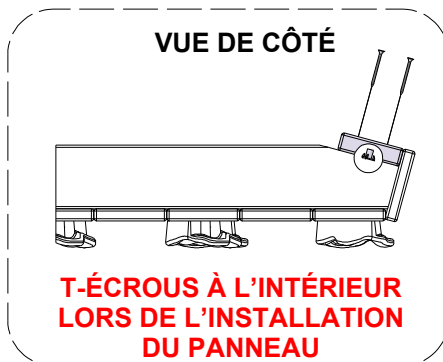
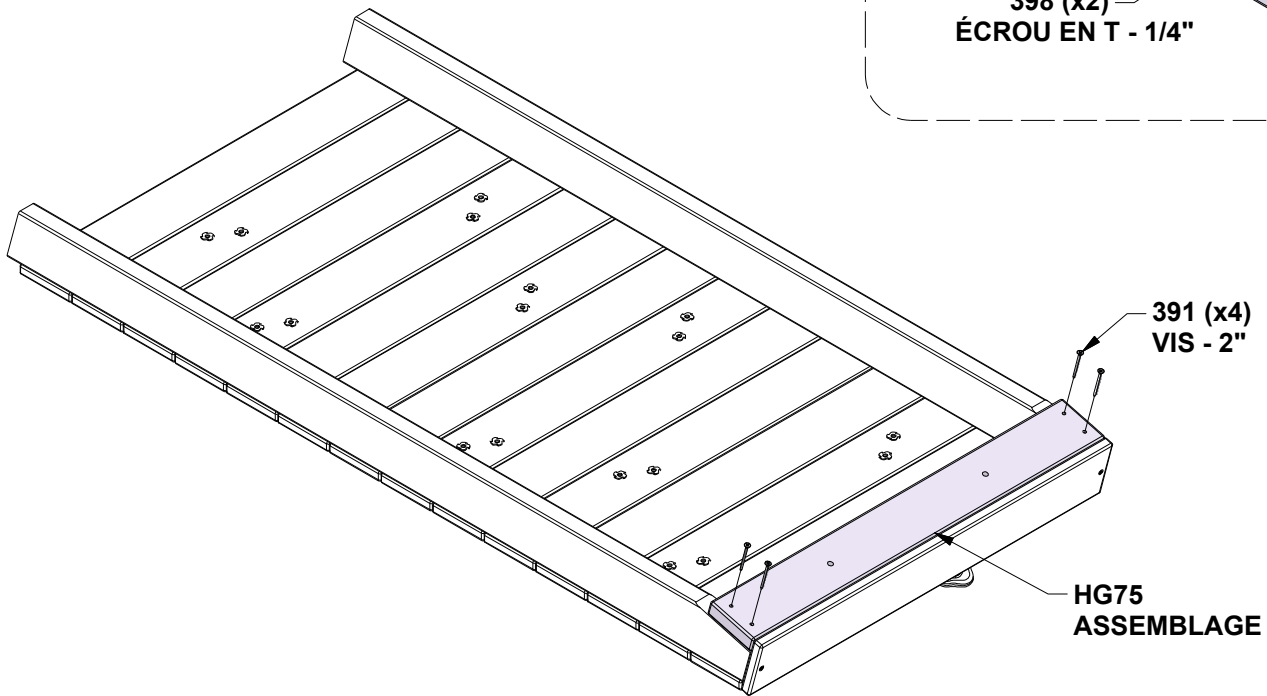
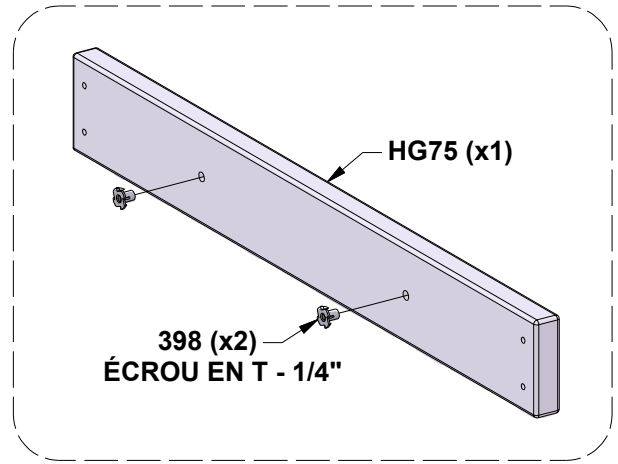

# ÉTAPE 1 - POUTRE DE BALANÇOIRE

QTÉ	N° DE PIÈCE	DESCRIPTION
5	H100192	ÉCROU EN BARILLET WH 5/16x7/8 BLK
5	H100416	BOULON WH 5/16x3 BLK

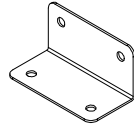
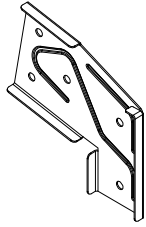
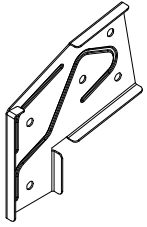

A100140 SUPPORT EN L  
(x2) 66x66x127

A4M02890 POUTRE DE  
(x1) BALANÇOIR- GAUCHE

A4M02891 POUTRE DE  
(x1) BALANÇOIR-DROIT



GJ74 POUTRE DE BALANÇOIRE LONG - W4L21025  
(x1) 3 1/4"x5 5/8"x89 1/2" (84x144x2274)

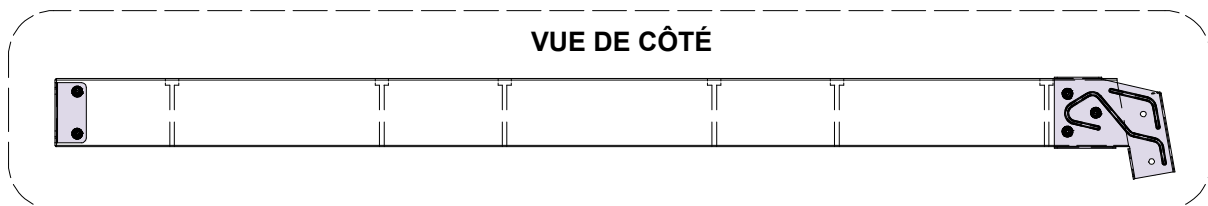
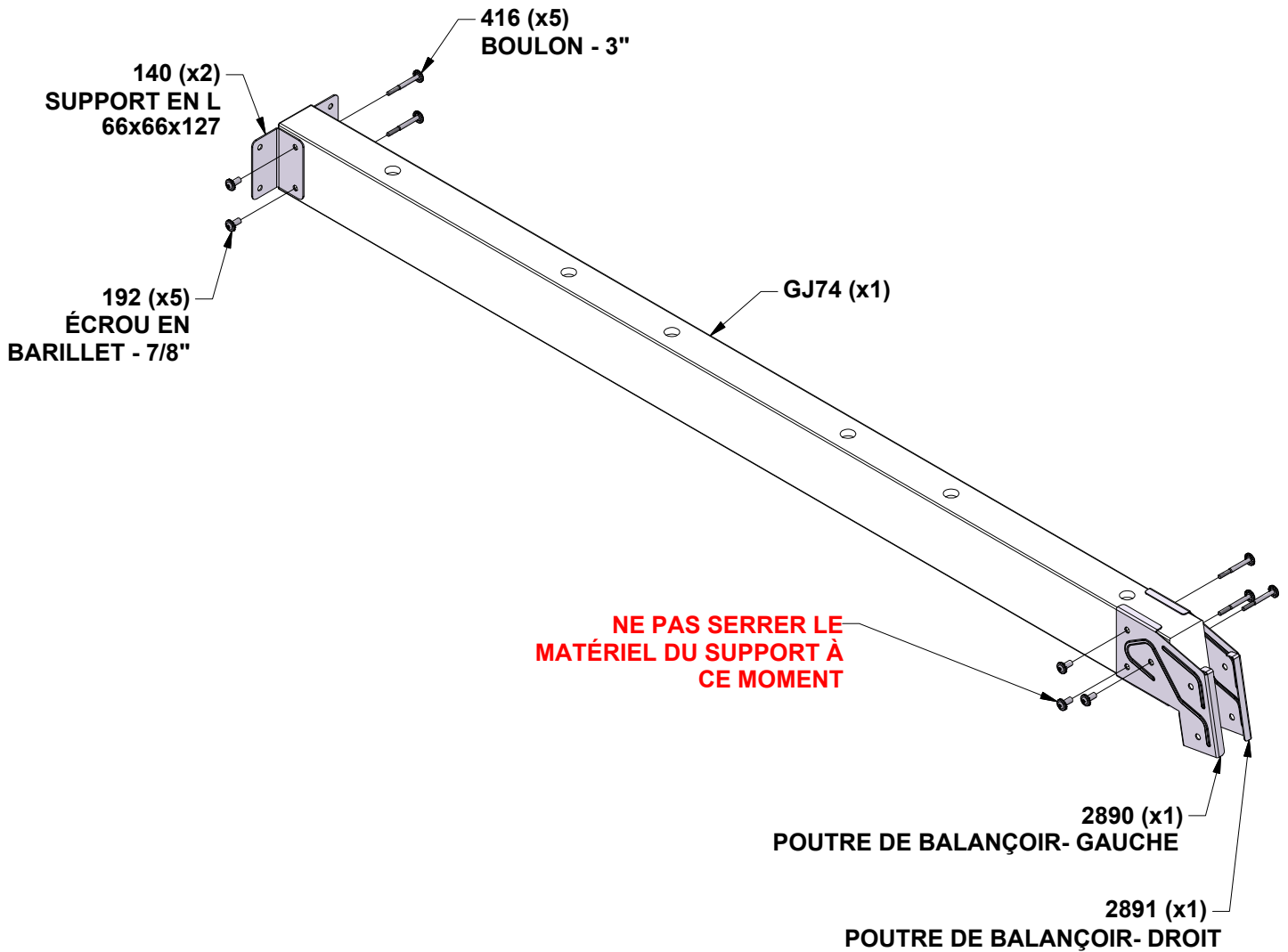

# ÉTAPE 2 - POUTRE DE BALANÇOIRE

QTÉ	N° DE PIÈCE	DESCRIPTION
6	H100103	RONDELLE DE SÉCURITÉ 17x30
6	H100105	RONDELLE PLATE 8x27
6	H100110	ECROU VERROU 5/16

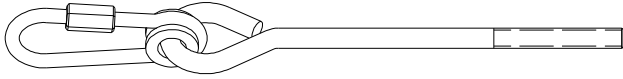

**A4M02894 PORTE- BALANÇOIRE QUICK LINK  
(x6)**

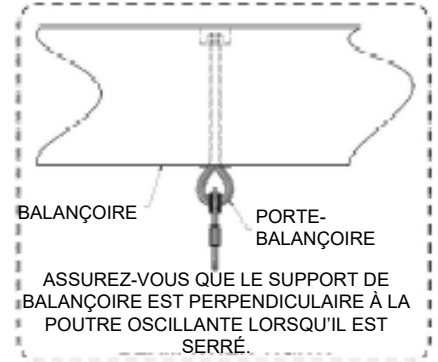
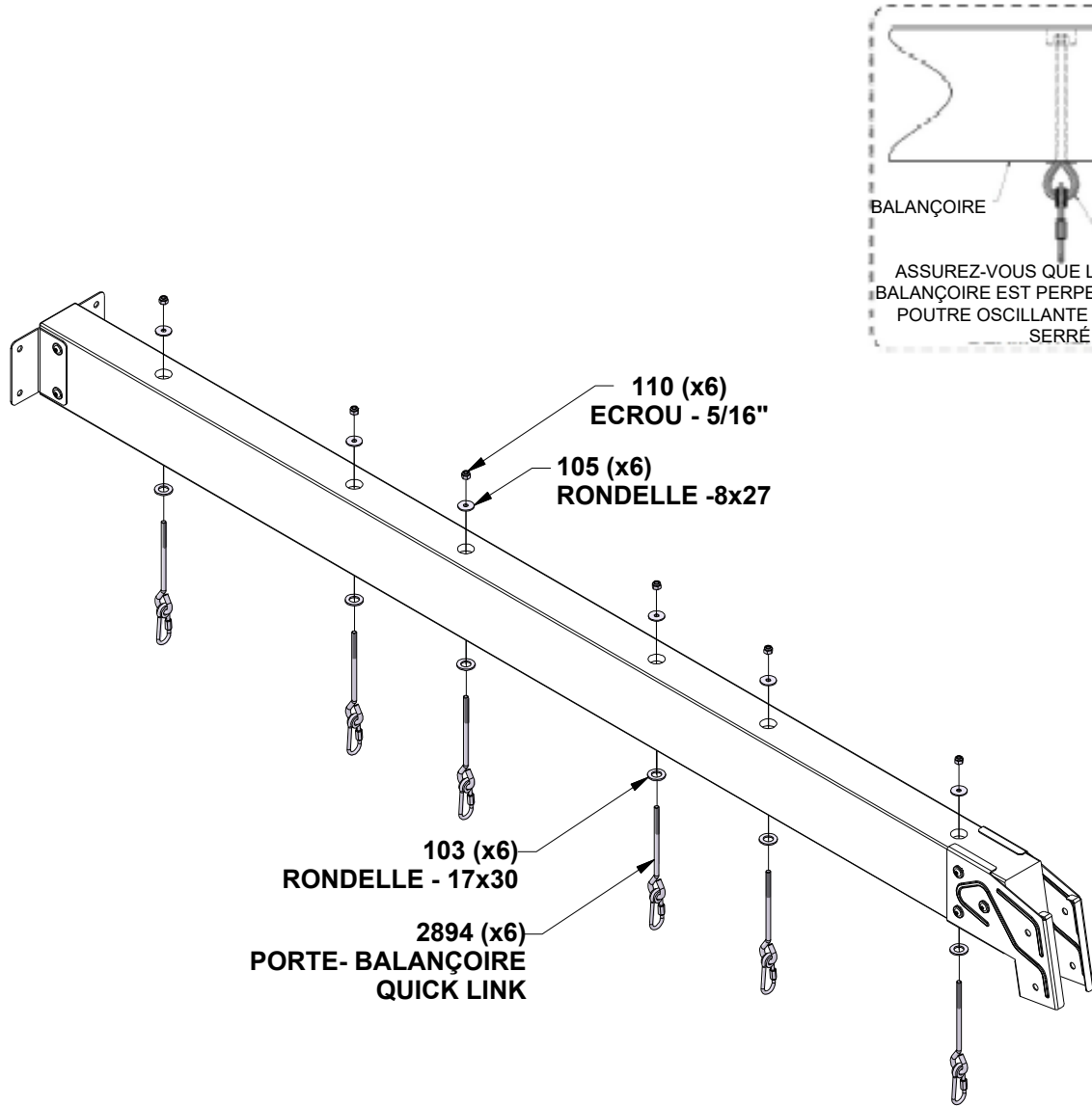

## ÉTAPE 3 - POUTRE DE BALANÇOIRE

QTÉ	N° DE PIÈCE	DESCRIPTION
6	H100379	ÉCROU EN T 5/16 BLK
4	H100407	BOULON WH 5/16x1 1/2 BLK
2	H100484	BOULON WH 5/16x3 1/4 BLK

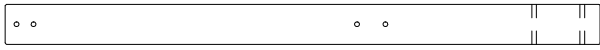

**GG71** SUPPORT À POUTRE DE BALANÇOIRE - W4L21021  
(x1) 3 1/4"x3 1/4"x49 5/8" (84x84x1260)

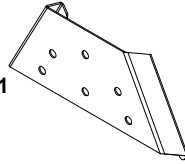

**A4M01169** SUPPORT DE CADRE A  
(x1)

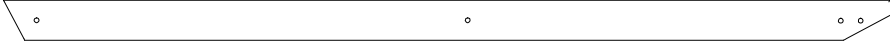

**EG77** SUPPORT À L'ANGLE - W4L21023  
(x2) 1 3/8"x3 1/4"x74 3/8" (36x84x1890)

**INSTALLEZ LES ÉCROUS EN T DANS LE BOIS TOUT D'ABORD**

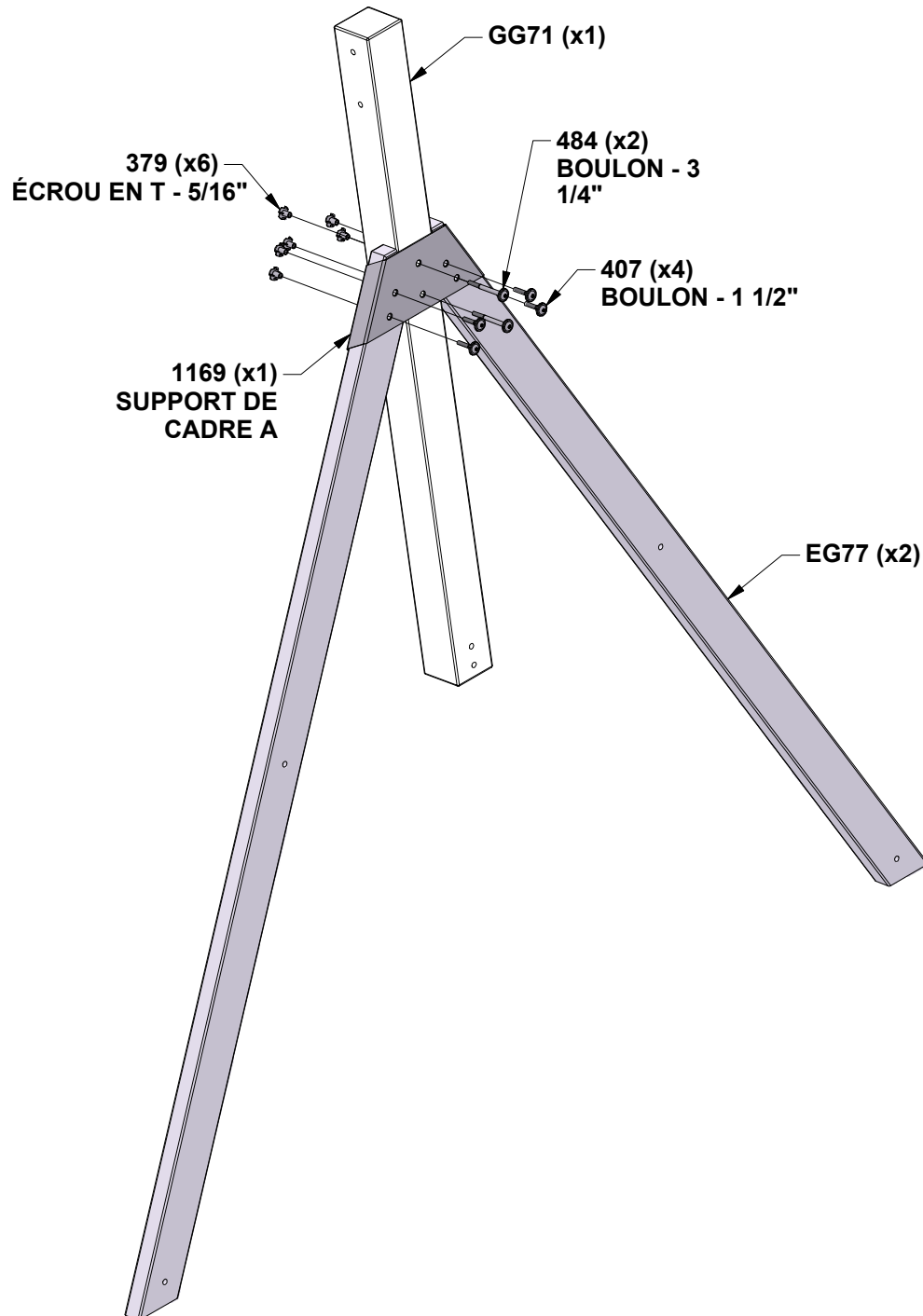

# ÉTAPE 4 - POUTRE DE BALANÇOIRE

QTÉ	N° DE PIÈCE	DESCRIPTION
4	H100194	BOULON WH 5/16x2-1/2 BLK
6	H100198	RONDELLE D'ARRET EXT 8x19 BLK
6	H100379	ÉCROU EN T 5/16 BLK
2	H100534	BOULON WH 5/16x4 1/2 BLK



OG07 SUPPORT D'EXTRÉMITÉ - W4L21024  
(x1) 1"x3 1/2"x41" (30x84x1045)



OG08 PLANCHE DE SOL - W4L21022  
(x1) 1 1/8"x3 1/4"x75" (30x84x1905)

**INSTALLEZ LES ÉCROUS EN T DANS LE BOIS TOUT D'ABORD**

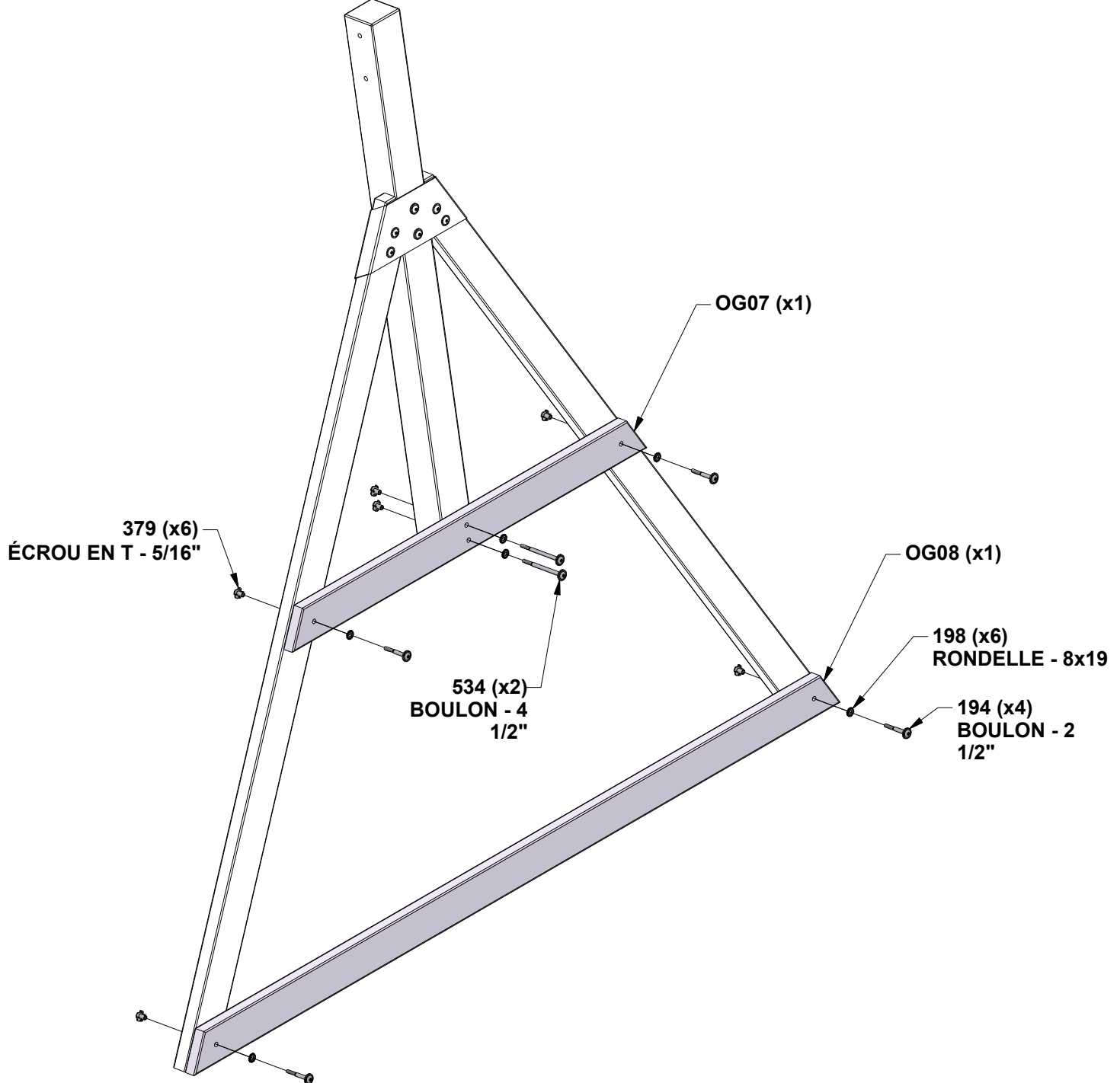

## ÉTAPE 5 - POUTRE DE BALANÇOIRE

QTÉ	N° DE PIÈCE	DESCRIPTION
2	H100192	ÉCROU EN BARILLET WH 5/16x7/8 BLK
2	H100416	BOULON WH 5/16x3 BLK

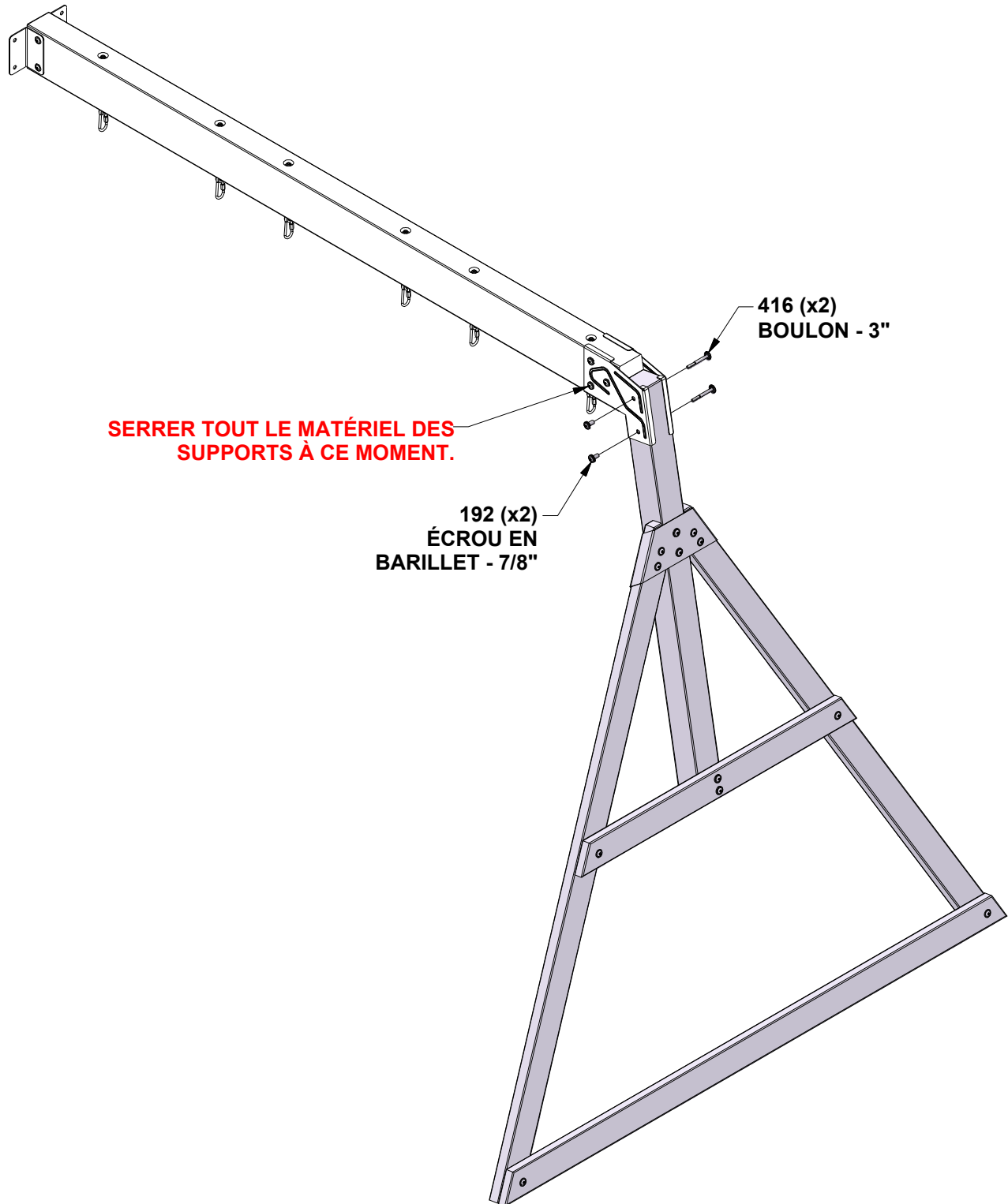

# ÉTAPE 1 - ASSEMBLAGE DE FORT

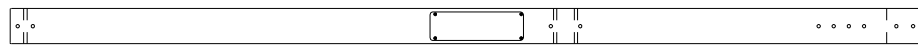

**OG01 MONTANT ASSEMBLAGE - W2A04237**  
(x1) 1 1/8"x3 1/4"x85 5/8" (30x84x2174)



**OG04 MONTANT - W4L19922**  
(x1) 1 1/8"x3 1/4"x85 5/8" (30x84x2174)

QTÉ	N° DE PIÈCE	DESCRIPTION
16	H100398	ÉCROU EN T 1/4 BLK
16	H100405	RONDELLE D'ARRET EXT 6x15 BLK
8	H100488	BOULON WH 1/4x2 BLK
8	H100567	BOULON WH 1/4x2-1/4 BLK



**OS01 SUPPORT DE POUTRE PIVOTANTE - W4L20965**  
(x1) 1 1/8"x3 3/4"x60 3/8" (30x96x1535)



**NJ02 RAIL AU SOL - W4L19923**  
(x1) 3/4"x4 1/8"x61 1/4" (20x106x1555)

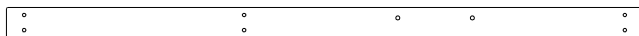

**OB02 SUPPORT DE POUTRE PIVOTANTE - W4L20964**  
(x1) 1 1/8"x2 7/8"x59 5/8" (30x72x1515)

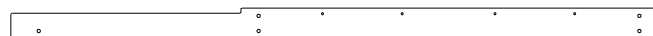

**HB04 PLANCHE DE SOL - W4L19916**  
(x1) 1"x2 7/8"x61 1/2" (24x72x1563)

## INSTALLEZ LES ÉCROUS EN T DANS LE BOIS TOUT D'ABORD

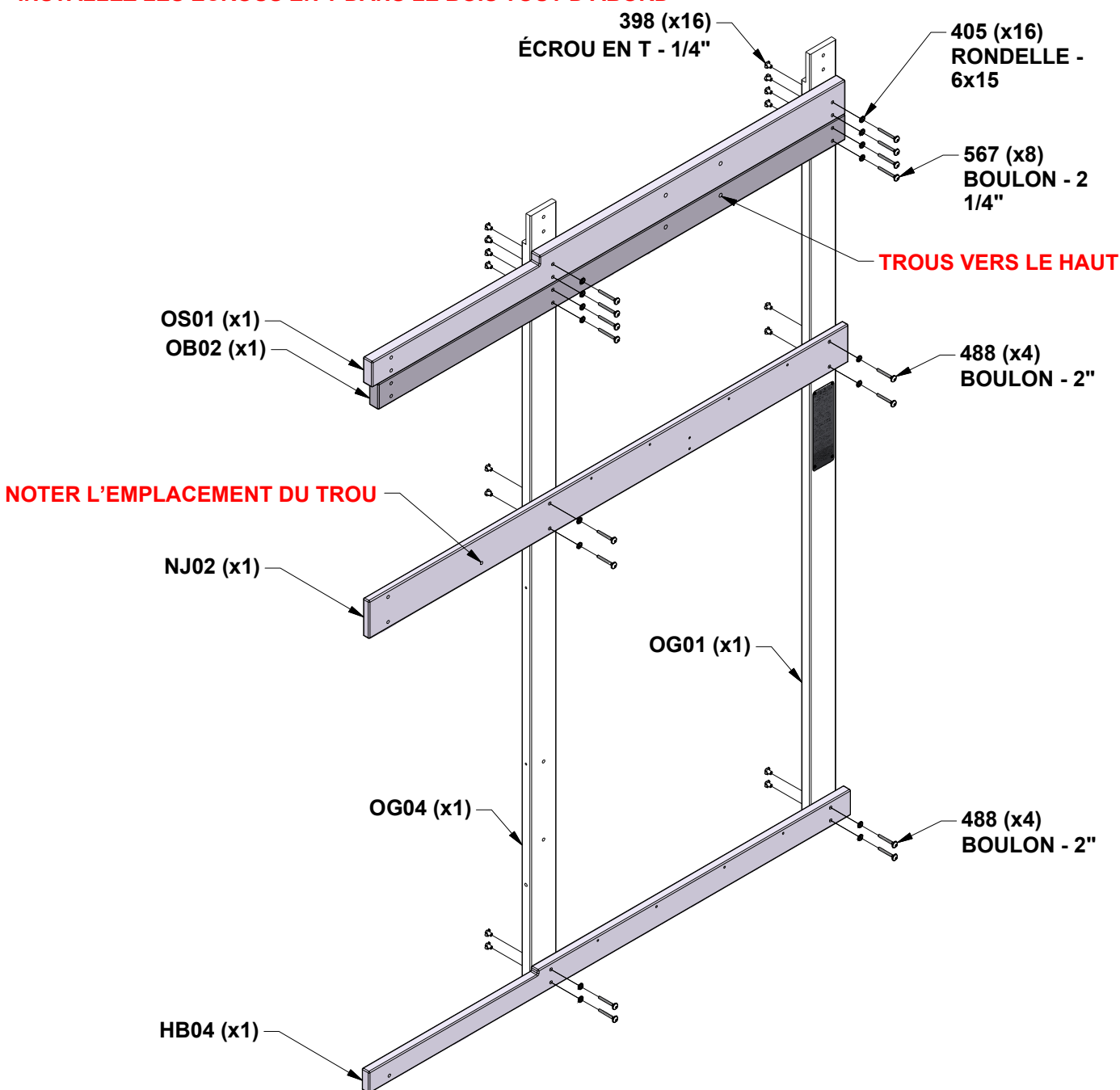

# ÉTAPE 2 - ASSEMBLAGE DE FORT



**OG09 MONTANT - W4L20961**  
(x2) 1 1/8"x3 1/4"x12 3/4" (30x84x325)



**NB12 RAIL MURAL - W4L20971**  
(x1) 3/4"x3 1/4"x39" (20x84x991)

QTÉ	N° DE PIÈCE	DESCRIPTION
4	H100171	BOULON WH 1/4x1 BLK
8	H100398	ÉCROU EN T 1/4 BLK
8	H100405	RONDELLE D'ARRET EXT 6x15 BLK
4	H100488	BOULON WH 1/4x2 BLK

**INSTALLEZ LES ÉCROUS EN T DANS LE BOIS TOUT D'ABORD**

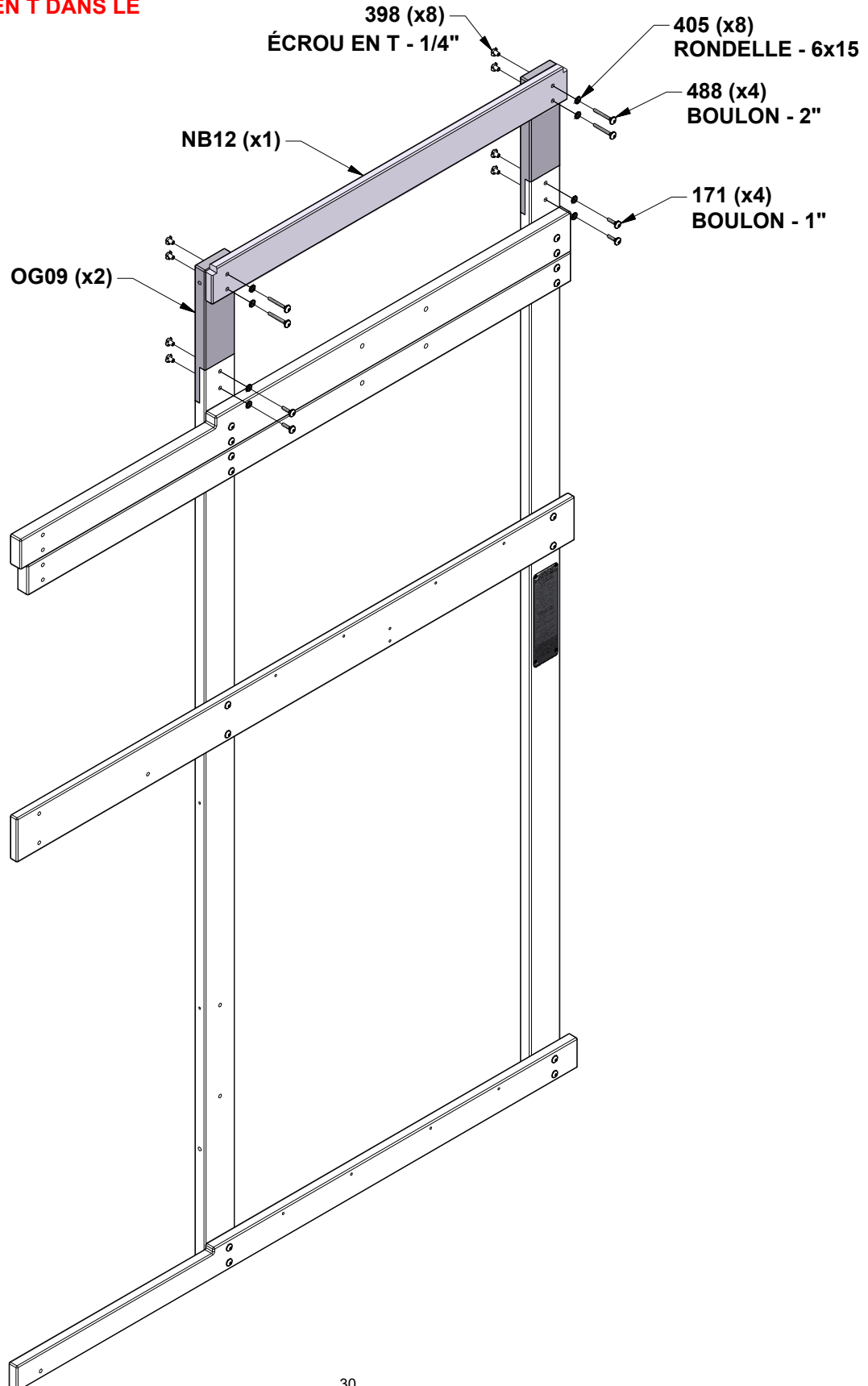

# ÉTAPE 3 - ASSEMBLAGE DE FORT

QTÉ	N° DE PIÈCE	DESCRIPTION
8	H100398	ÉCROU EN T 1/4 BLK
8	H100405	RONDELLE D'ARRET EXT 6x15 BLK
8	H100488	BOULON WH 1/4x2 BLK



**OG02 MONTANT - W4L19920**  
(x1) 1 1/8"x3 1/4"x85 5/8" (30x84x2174)

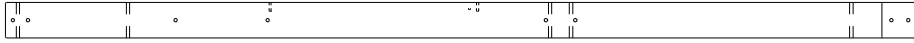

**OG03 MONTANT - W4L19921**  
(x1) 1 1/8"x3 1/4"x85 5/8" (30x84x2174)



**NJ03 RAIL AU SOL - W4L19926**  
(x1) 3/4"x4 1/8"x39" (20x106x991)

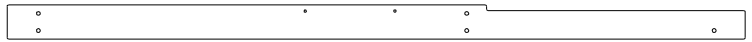

**HB01 PLANCHE DE SOL - W4L19917**  
(x1) 1"x2 7/8"x61 1/2" (24x72x1563)

## INSTALLEZ LES ÉCROUS EN T DANS LE BOIS TOUT D'ABORD

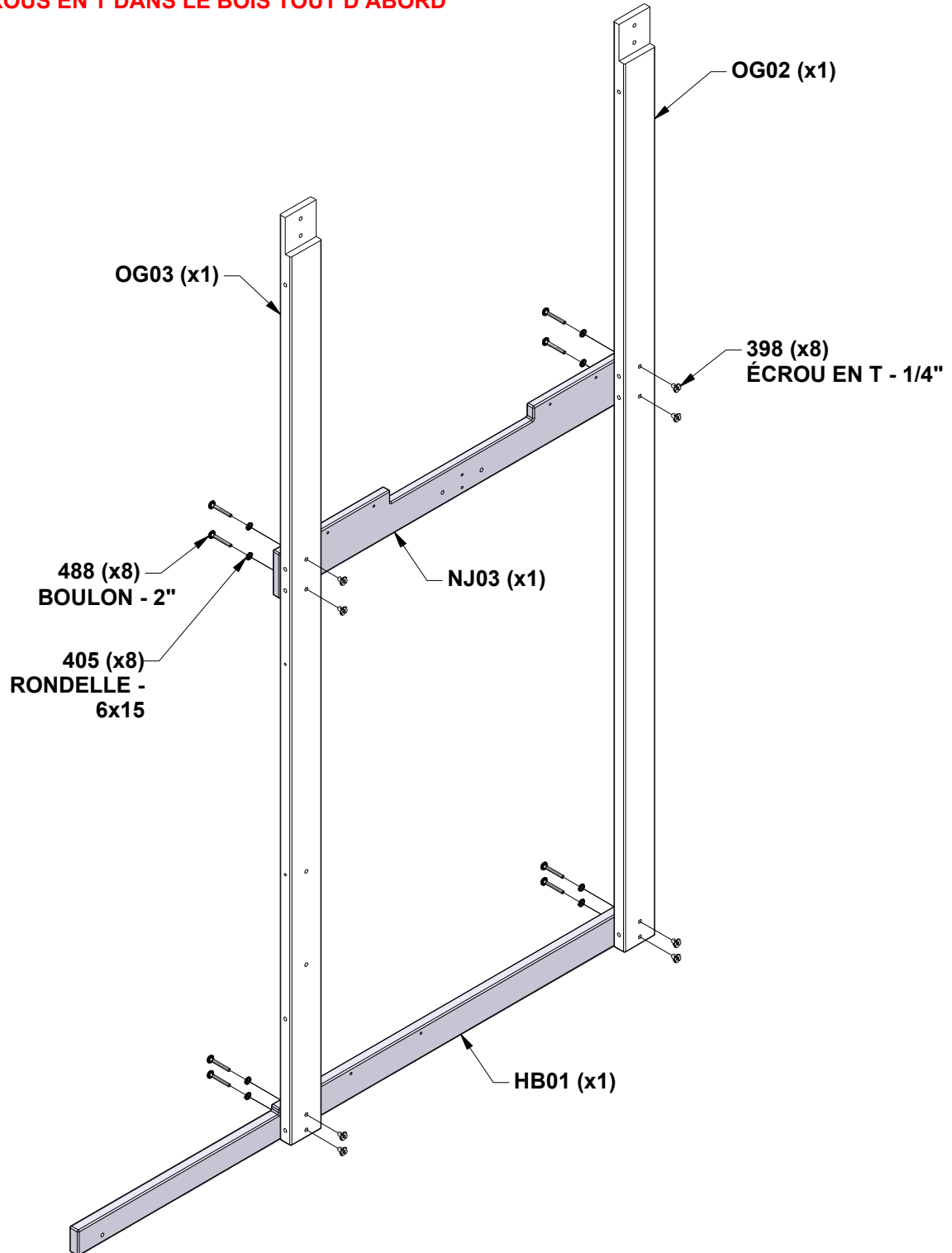

# ÉTAPE 4 - ASSEMBLAGE DE FORT



**OG09 MONTANT - W4L20961**  
 (x2) 1 1/8"x3 1/4"x12 3/4" (30x84x325)



**NB12 RAIL MURAL - W4L20971**  
 (x1) 3/4"x3 1/4"x39" (20x84x991)

QTÉ	N° DE PIECE	DESCRIPTION
4	H100171	BOULON WH 1/4x1 BLK
8	H100398	ÉCROU EN T 1/4 BLK
8	H100405	RONDELLE D'ARRET EXT 6x15 BLK
4	H100488	BOULON WH 1/4x2 BLK

**INSTALLEZ LES ÉCROUS EN T DANS LE BOIS TOUT D'ABORD**

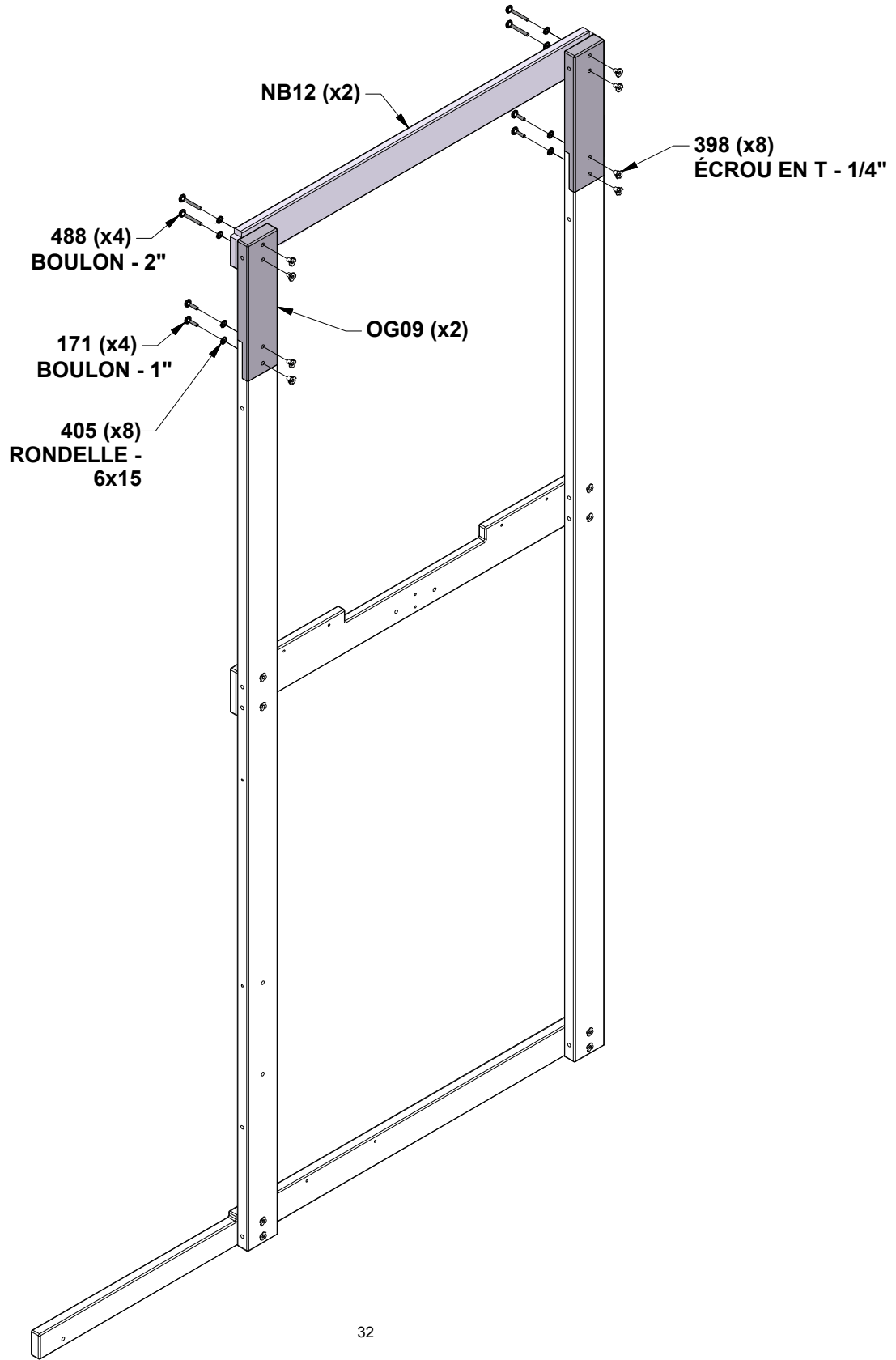

# ÉTAPE 5 - ASSEMBLAGE DE FORT

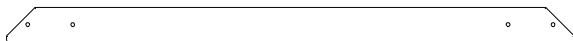

**NB03 RAIL MURAL - W4L20973**  
(x1) 3/4"x2 7/8"x47 3/8" (20x72x1202)



**NB16 RAIL MURAL - W4L20982**  
(x1) 3/4"x2 7/8"x37 1/2" (20x72x952)

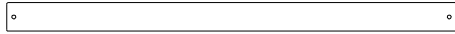

**HR02 PLANCHE DE SOL - W4L19919**  
(x1) 1"x2 3/8"x37 1/2" (24x60x952)

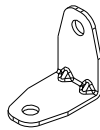

**A4M04303 SUPPORT EN L**  
(x1) 2.5x38x38x49

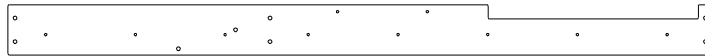

**NJ01 RAIL AU SOL - W4L19924**  
(x1) 3/4"x4 1/8"x58 3/4" (20x106x1492)

QTÉ	N° DE PIÈCE	DESCRIPTION
9	H100398	ÉCROU EN T 1/4 BLK
10	H100405	RONDELLE D'ARRET EXT 6x15 BLK
2	H100487	TIREFOND WH 1/4x2 BLK
1	H101139	BOULON WH 1/4x7/8 BLK
2	H101174	BOULON WH 1/4x4 1/4 BLK
6	H101368	BOULON WH 1/4x4 BLK

**INSTALLEZ LES ÉCROUS EN T DANS LE BOIS TOUT D'ABORD**

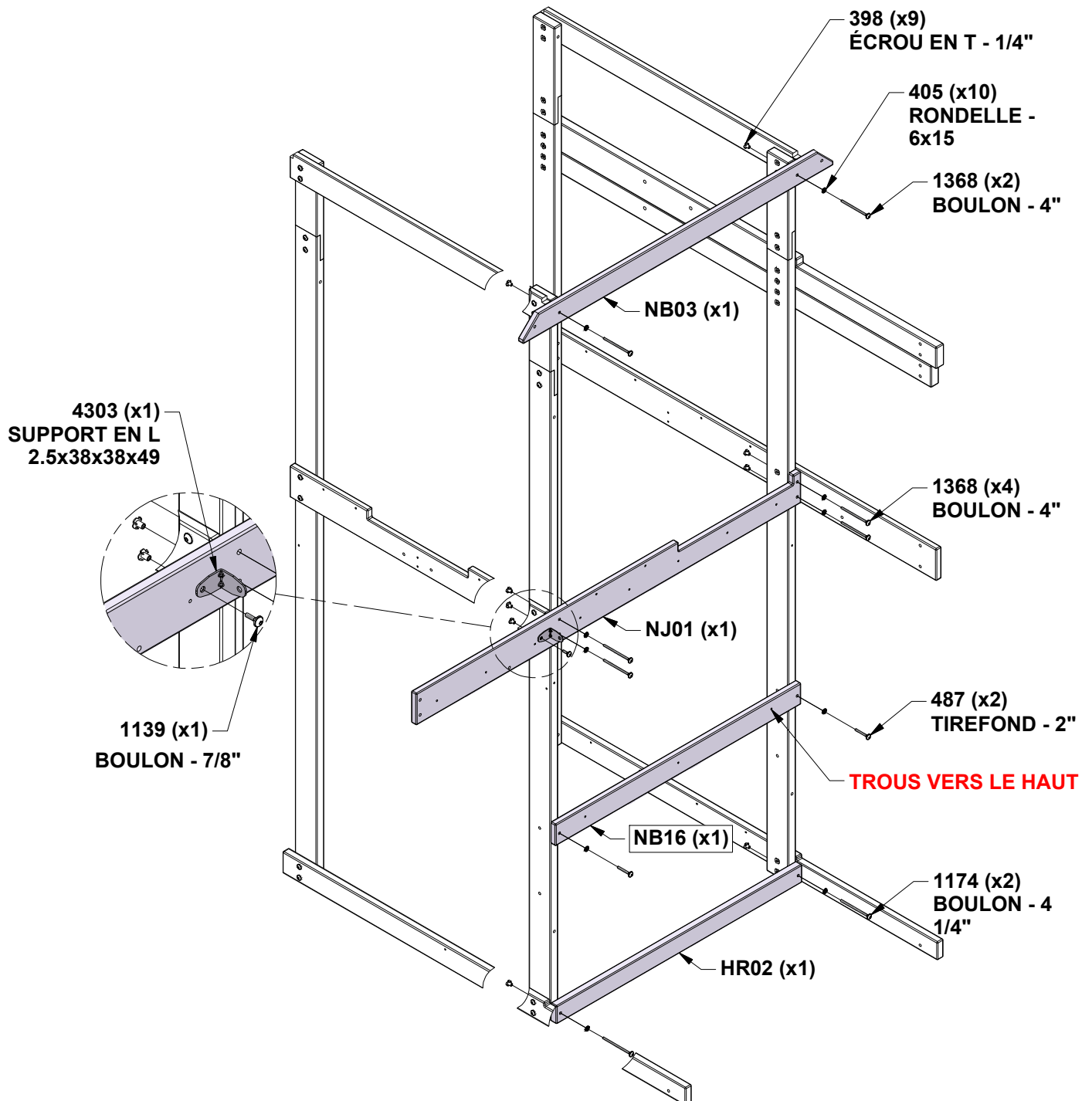

# ÉTAPE 6 - ASSEMBLAGE DE FORT

QTÉ	N° DE PIÈCE	DESCRIPTION
8	H100398	ÉCROU EN T 1/4 BLK
8	H100405	RONDELLE D'ARRET EXT 6x15 BLK
2	H101174	BOULON WH 1/4x4 1/4 BLK
6	H101368	BOULON WH 1/4x4 BLK

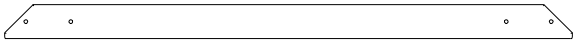

**NB03 RAIL MURAL - W4L20973**  
(x1) 3/4"x2 7/8"x47 3/8" (20x72x1202)



**HB02 PLANCHE DE SOL - W4L19918**  
(x1) 1"x2 7/8"x37 1/2" (24x72x952)

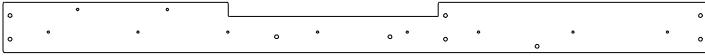

**NJ04 RAIL AU SOL - W4L19925**  
(x1) 3/4"x4 1/8"x58 3/4" (20x106x1492)

**INSTALLEZ LES ÉCROUS EN T DANS LE BOIS TOUT D'ABORD**

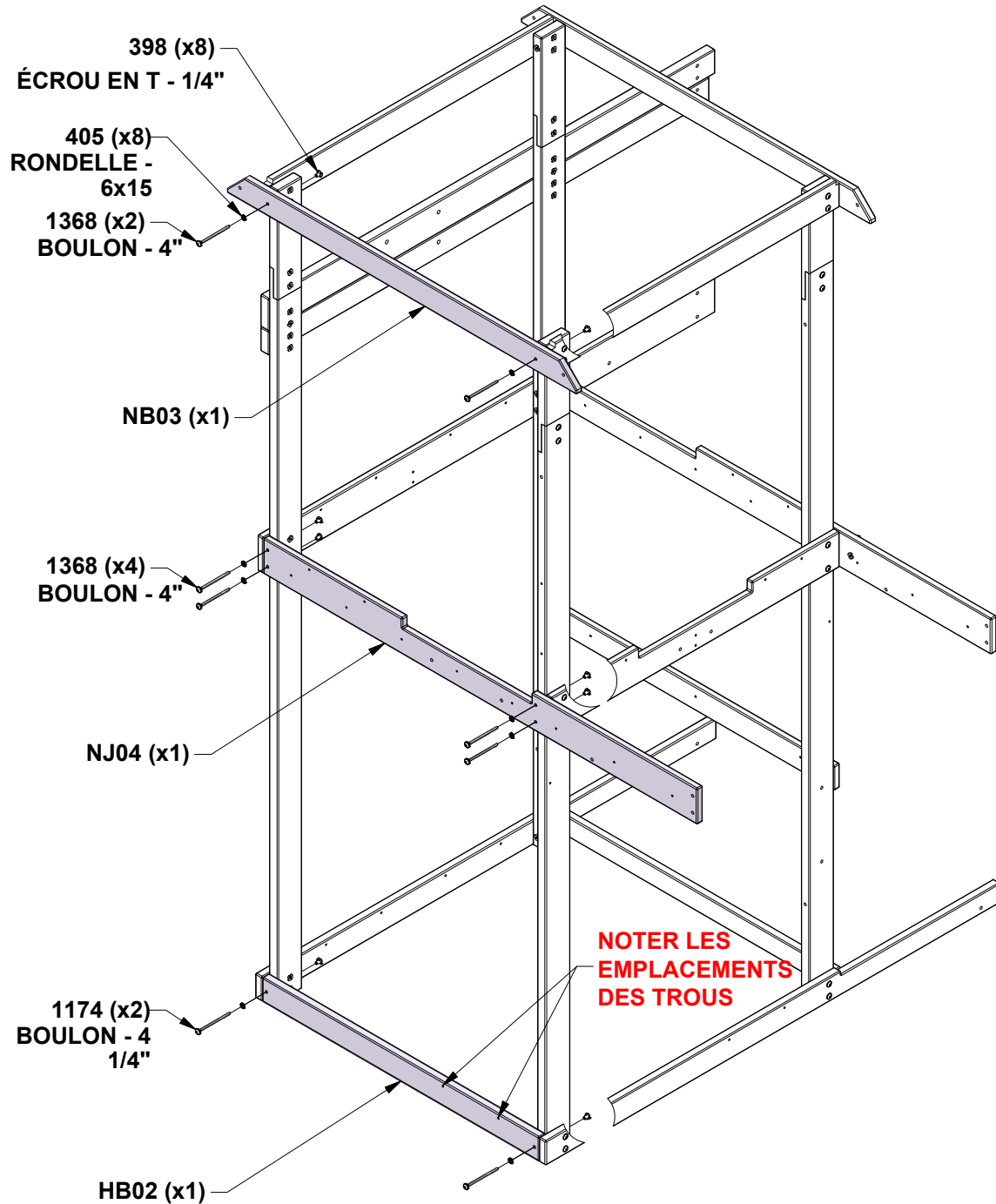

# ÉTAPE 7 - ASSEMBLAGE DE FORT

QTÉ	N° DE PIÈCE	DESCRIPTION
3	H100398	ÉCROU EN T 1/4 BLK
2	H100405	RONDELLE D'ARRET EXT 6x15 BLK
1	H101139	BOULON WH 1/4x7/8 BLK
2	H101368	BOULON WH 1/4x4 BLK



**NB01 RAIL DE MUR ARQUÉ - W4L20969**  
(x1) 3/4"x2 7/8"x42" (20x72x1066)

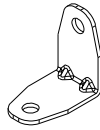

**A4M04303 SUPPORT EN L**  
(x1) 2.5x38x38x49



**NB04 RAIL MURAL - W4L20967**  
(x1) 3/4"x2 7/8"x23 1/4" (20x72x590)

**INSTALLEZ LES ÉCROUS EN T DANS LE BOIS TOUT D'ABORD**

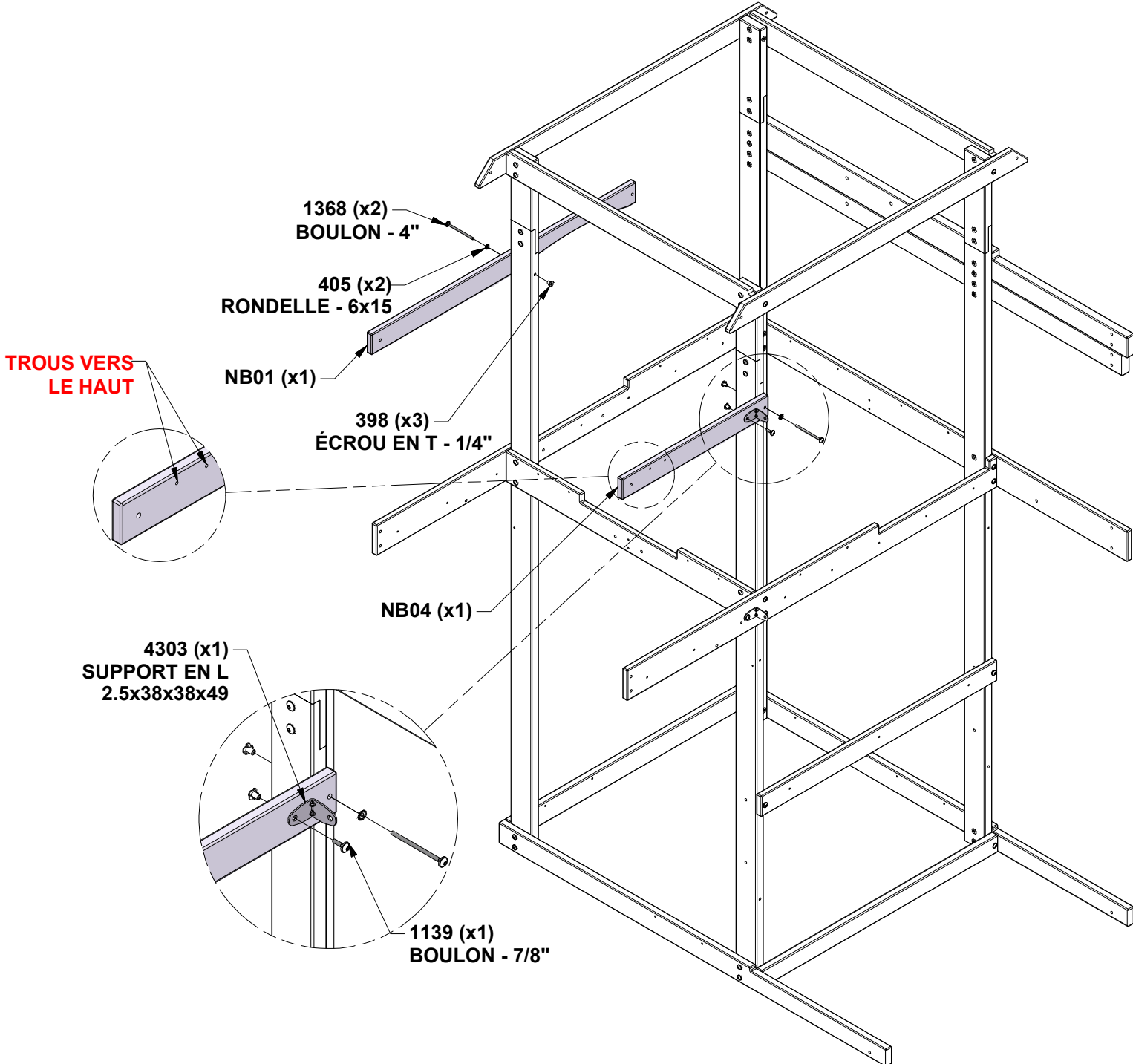

# ÉTAPE 8 - ASSEMBLAGE DE FORT

QTÉ	N° DE PIÈCE	DESCRIPTION
14	H100398	ÉCROU EN T 1/4 BLK
14	H100405	RONDELLE D'ARRET EXT 6x15 BLK
8	H100488	BOULON WH 1/4x2 BLK
6	H100800	BOULON WH 1/4x3 BLK

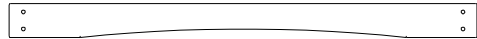

**NB05 RAIL MURAL - W4L20970**  
(x1) 3/4"x2 7/8"x39" (20x72x991)

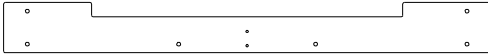

**NJ07 RAIL AU SOL - W4L19935**  
(x1) 3/4"x4 1/8"x40 5/8" (20x106x1031)

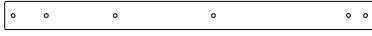

**OB04 BALCON MONTANT -W4L19933**  
(x2) 1 1/8"x2 3/8"x30 3/4" (30x60x782)

**INSTALLEZ LES ÉCROUS EN T DANS LE BOIS TOUT D'ABORD**

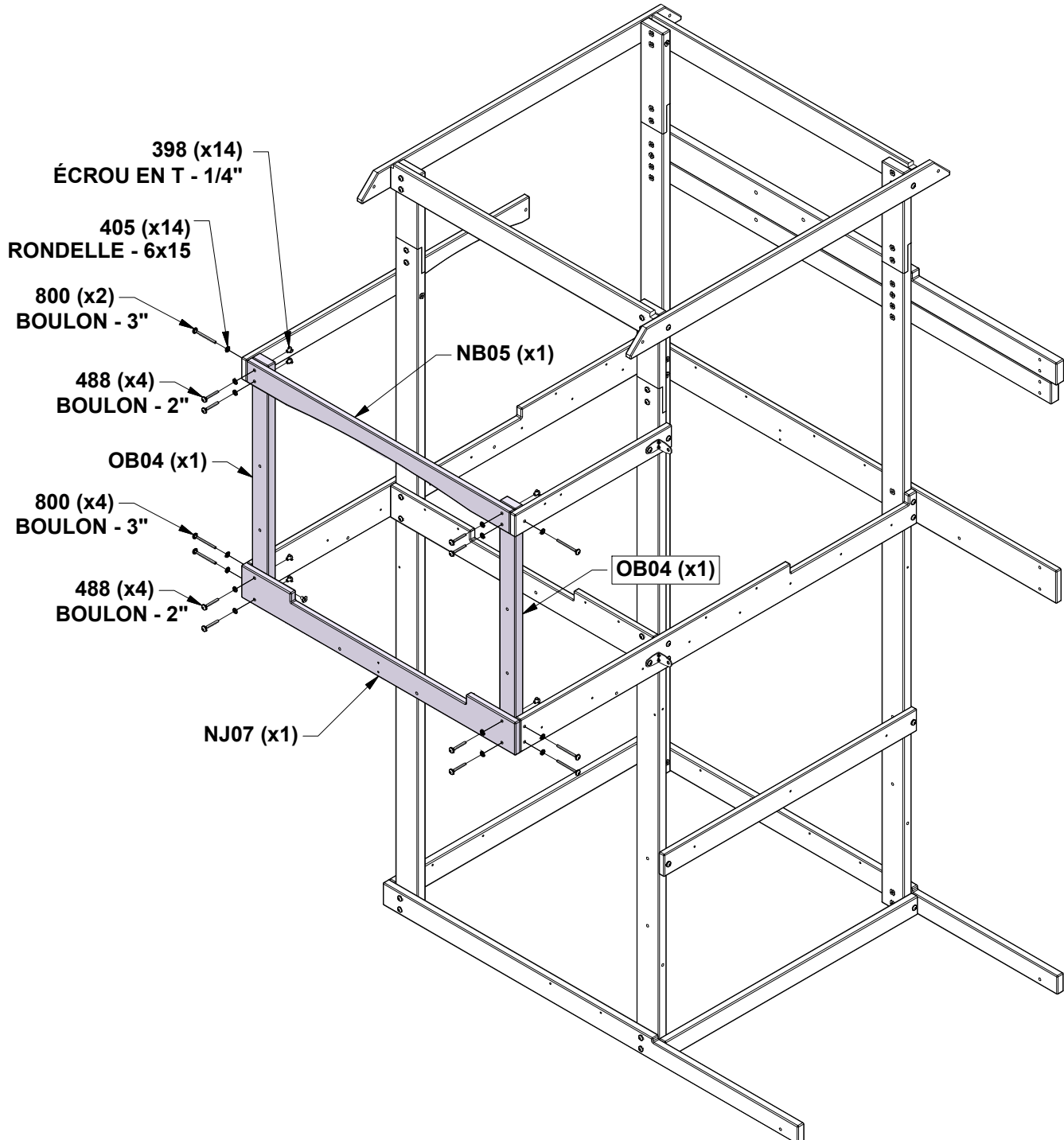

# ÉTAPE 9 - ASSEMBLAGE DE FORT

QTÉ	N° DE PIÈCE	DESCRIPTION
2	H100398	ÉCROU EN T 1/4 BLK
2	H100403	TIREFOND WH 1/4x1-1/2 BLK
4	H100405	RONDELLE D'ARRET EXT 6x15 BLK
2	H100488	BOULON WH 1/4x2 BLK



OR01 SUPPORT AU TERRASSE EN BOIS - W4L21008  
(x2) 1 1/8"x2 3/8"x13 1/8" (30x60x332)

**INSTALLEZ LES ÉCROUS EN T DANS LE BOIS TOUT D'ABORD**

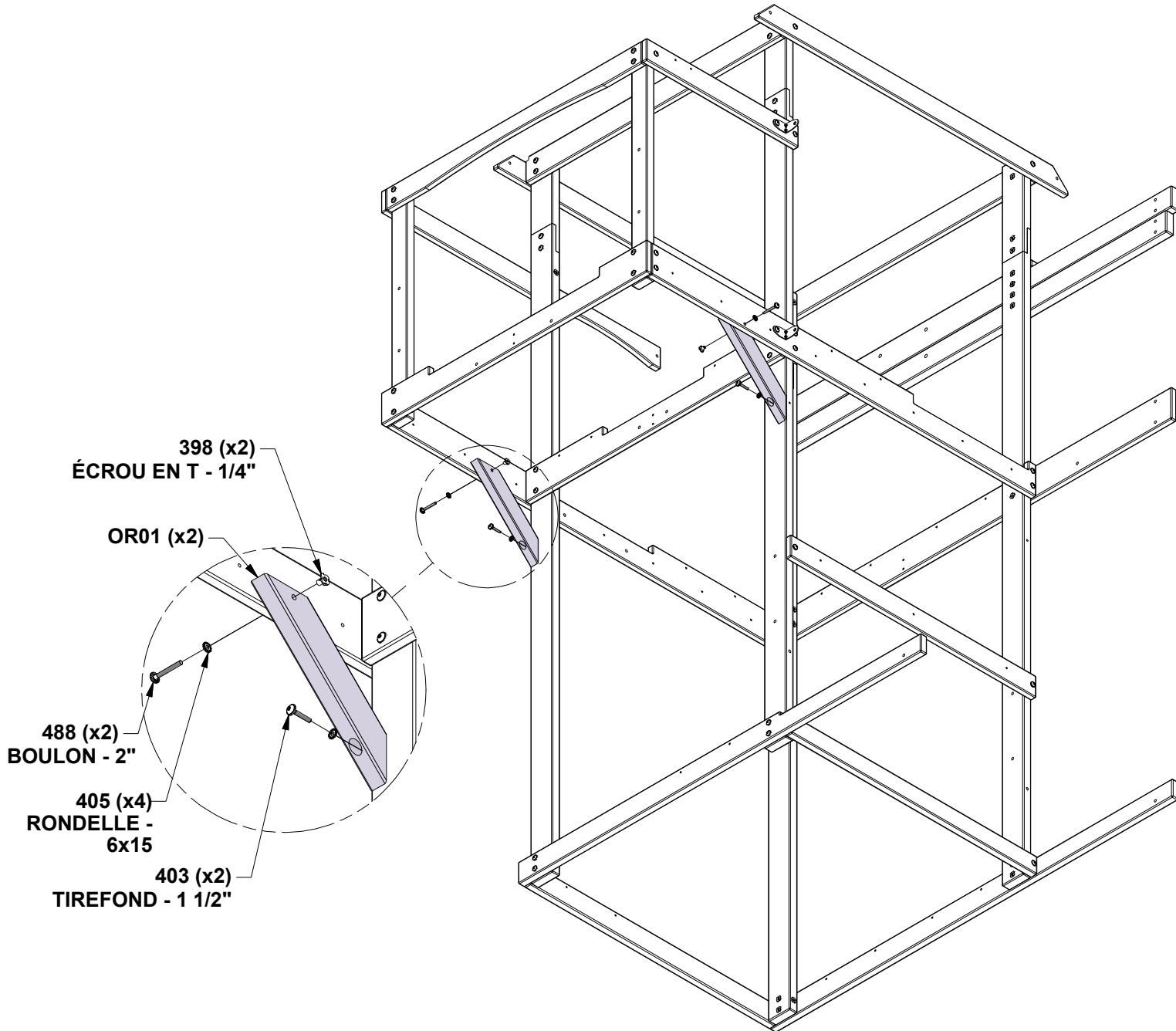

# ÉTAPE 10 - ASSEMBLAGE DE FORT

QTÉ	N° DE PIÈCE	DESCRIPTION
2	H100398	ÉCROU EN T 1/4 BLK
2	H101139	BOULON WH 1/4x7/8 BLK



**NB06 RAIL MURAL - W4L20968**  
(x1) 3/4"x2 7/8"x20 5/8" (20x72x524)



**NJ05 RAIL AU SOL - W4L19927**  
(x1) 3/4"x4 1/8"x20 5/8" (20x106x524)

**INSTALLEZ LES ÉCROUS EN T DANS LE BOIS TOUT D'ABORD**

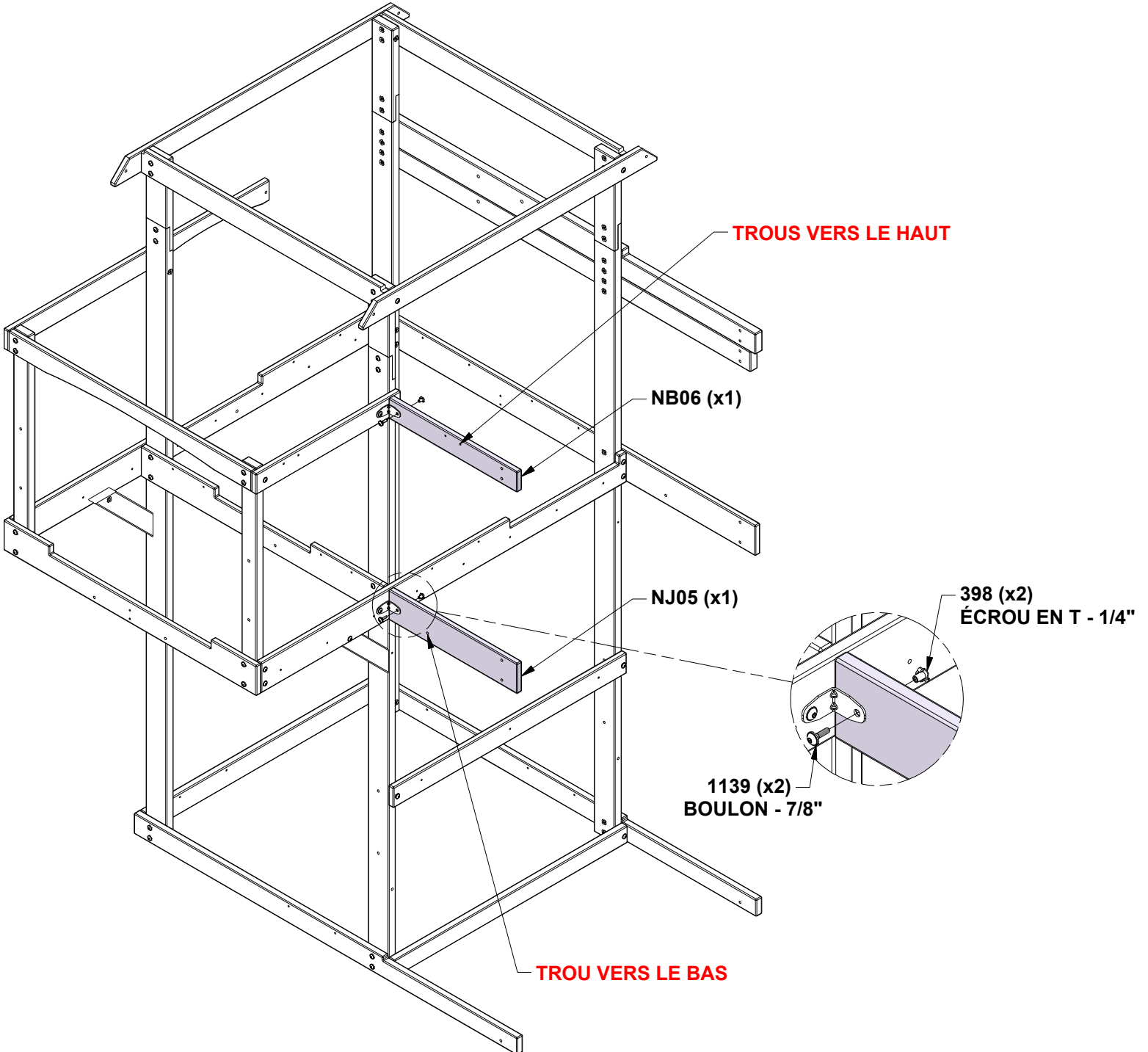

# ÉTAPE 11 - ASSEMBLAGE DE FORT

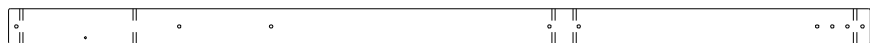

**OG05 MONTANT - W4L21027**  
(x1) 1 1/8"x3 1/4"x80 3/4" (30x84x2052)



**OG06 MONTANT - W4L19929**  
(x1) 1 1/8"x3 1/4"x80 3/4" (30x84x2052)

QTÉ	N° DE PIÈCE	DESCRIPTION
12	H100398	ÉCROU EN T 1/4 BLK
12	H100405	RONDELLE D'ARRET EXT 6x15 BLK
8	H100488	BOULON WH 1/4x2 BLK
4	H100567	BOULON WH 1/4x2-1/4 BLK

**INSTALLEZ LES ÉCROUS EN T DANS LE BOIS TOUT D'ABORD**

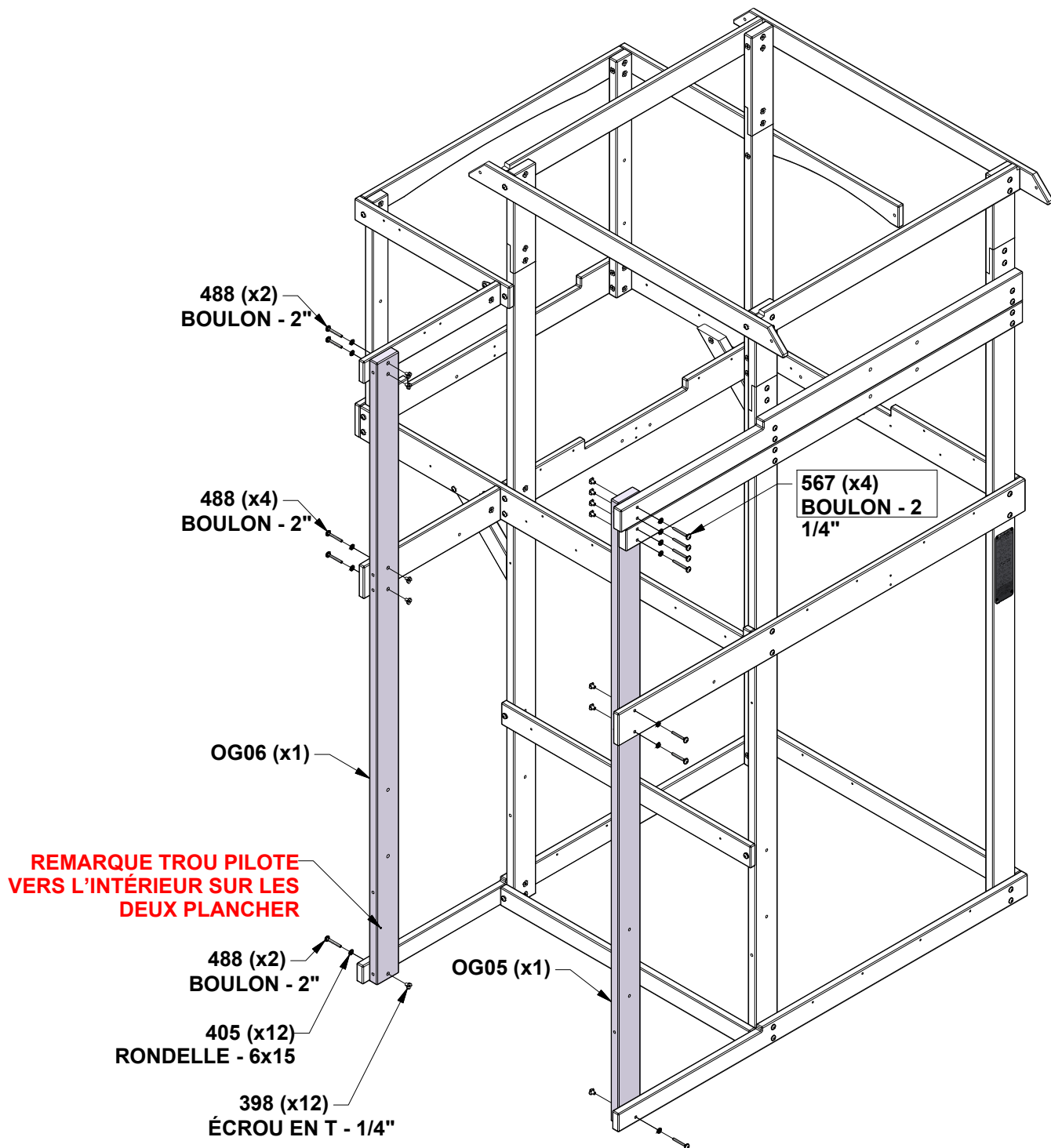

# ÉTAPE 12 - ASSEMBLAGE DE FORT

QTÉ	N° DE PIÈCE	DESCRIPTION
8	H100398	ÉCROU EN T 1/4 BLK
8	H100405	RONDELLE D'ARRET EXT 6x15 BLK
2	H101174	BOULON WH 1/4x4 1/4 BLK
6	H101368	BOULON WH 1/4x4 BLK



**NB02 RAIL MURAL - W4L20966**  
(x1) 3/4"x2 7/8"x37 1/2" (20x72x952)

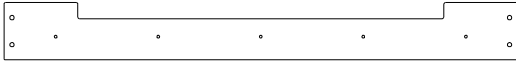

**NJ06 RAIL AU SOL - W4L19928**  
(x1) 3/4"x4 1/8"x37 1/2" (20x106x952)

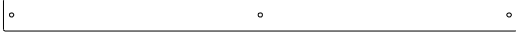

**HR08 PANNEAU DE SOL DU PORCHE - W4L19932**  
(x1) 1"x2 3/8"x37 1/2" (24x60x952)

**INSTALLEZ LES ÉCROUS EN T DANS LE BOIS TOUT D'ABORD**

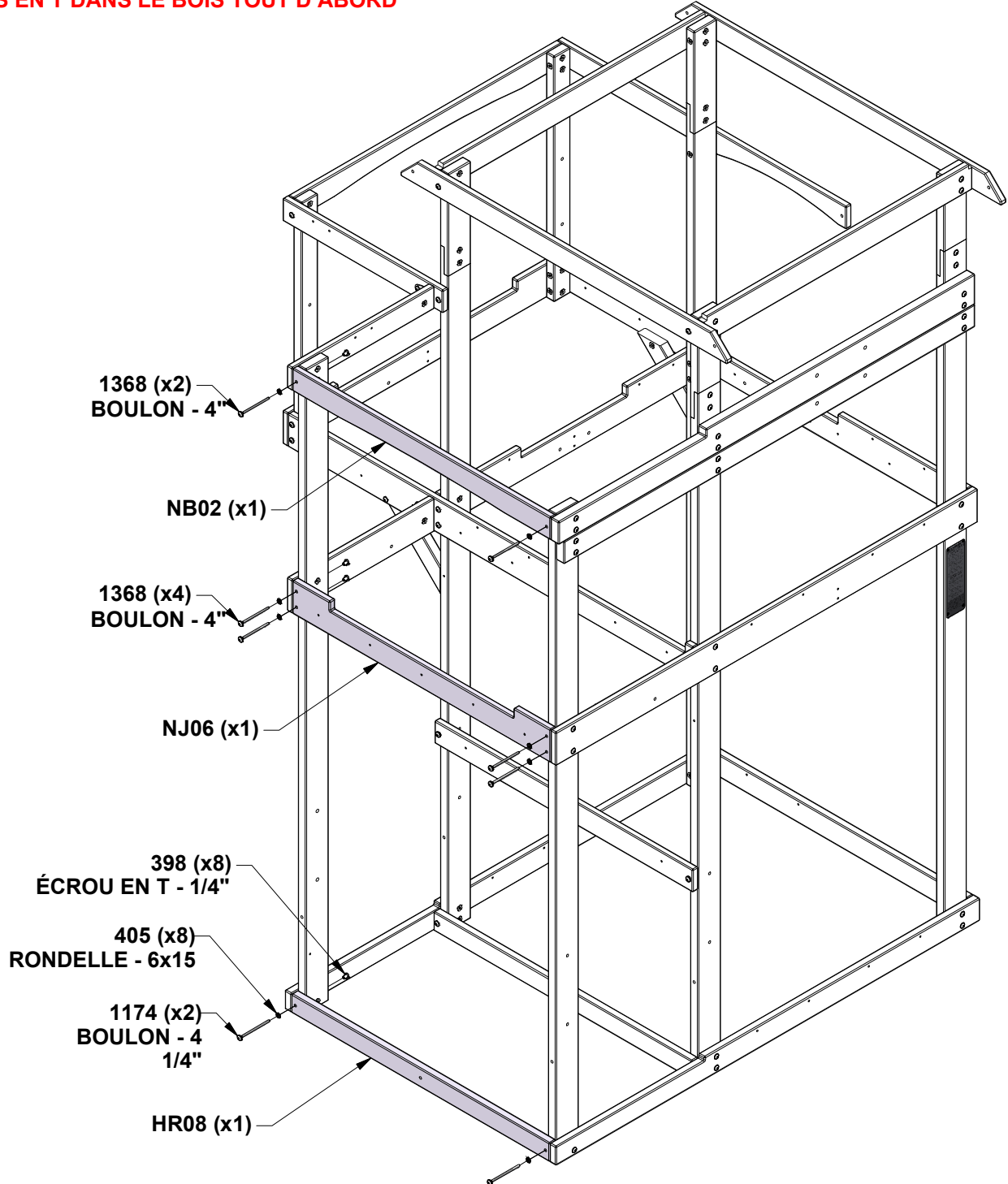

# ÉTAPE 13 - ASSEMBLAGE DE FORT

QTÉ	N° DE PIÈCE	DESCRIPTION
2	H100398	ÉCROU EN T 1/4 BLK
2	H100403	TIREFOND WH 1/4x1-1/2 BLK
4	H100405	RONDELLE D'ARRET EXT 6x15 BLK
2	H100488	BOULON WH 1/4x2 BLK



**OR01 SUPPORT AU TERRASSE EN BOIS - W4L21008**  
 (x2) 1 1/8"x2 3/8"x13 1/8" (30x60x332)

**INSTALLEZ LES ÉCROUS EN T DANS LE BOIS TOUT D'ABORD**

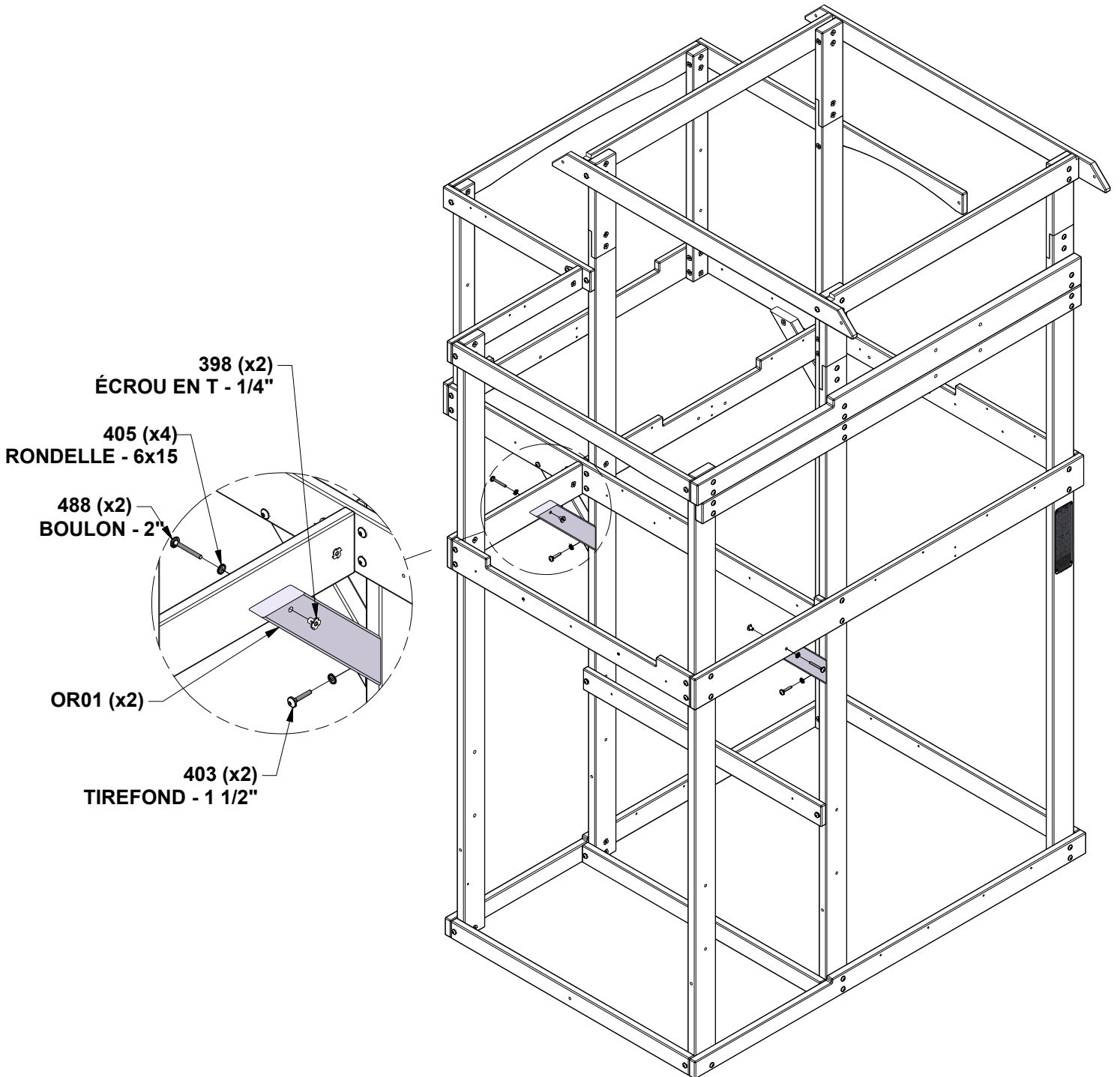

# ÉTAPE 14 - ASSEMBLAGE DE FORT



**OR02 SOLIVE DE SOL - W4L20994**  
(x1) 1 1/8"x2 3/8"x37 1/2" (30x60x952)

QTÉ	N° DE PIÈCE	DESCRIPTION
10	H100382	VIS PFH 8x1 3/4 BLK
4	H100391	VIS PFH 8x2 BLK
2	H100398	ÉCROU EN T 1/4 BLK



**PP01 PLANCHE DE SUPPORT - W4L20991**  
(x2) 1 1/4"x1 1/4"x35 1/8" (32x32x891)

**INSTALLER DES ÉCROUS EN T DANS LE BOIS D'ABORD ALIGNER LES TROUS PILOTES DANS LA SOLIVE DU PLANCHER**

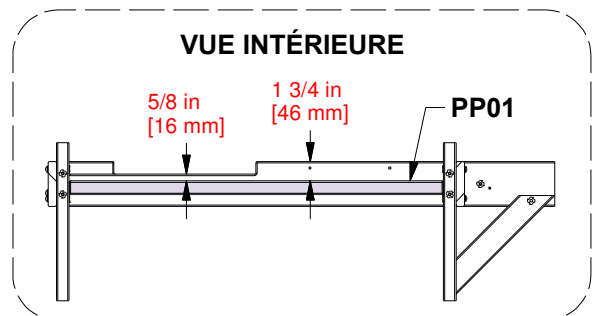
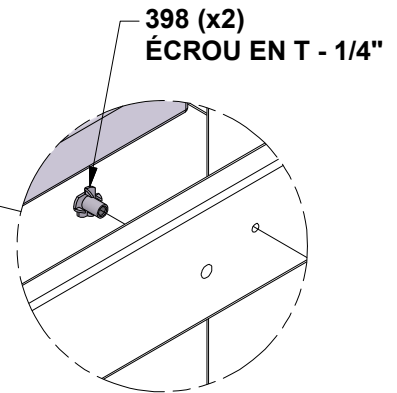
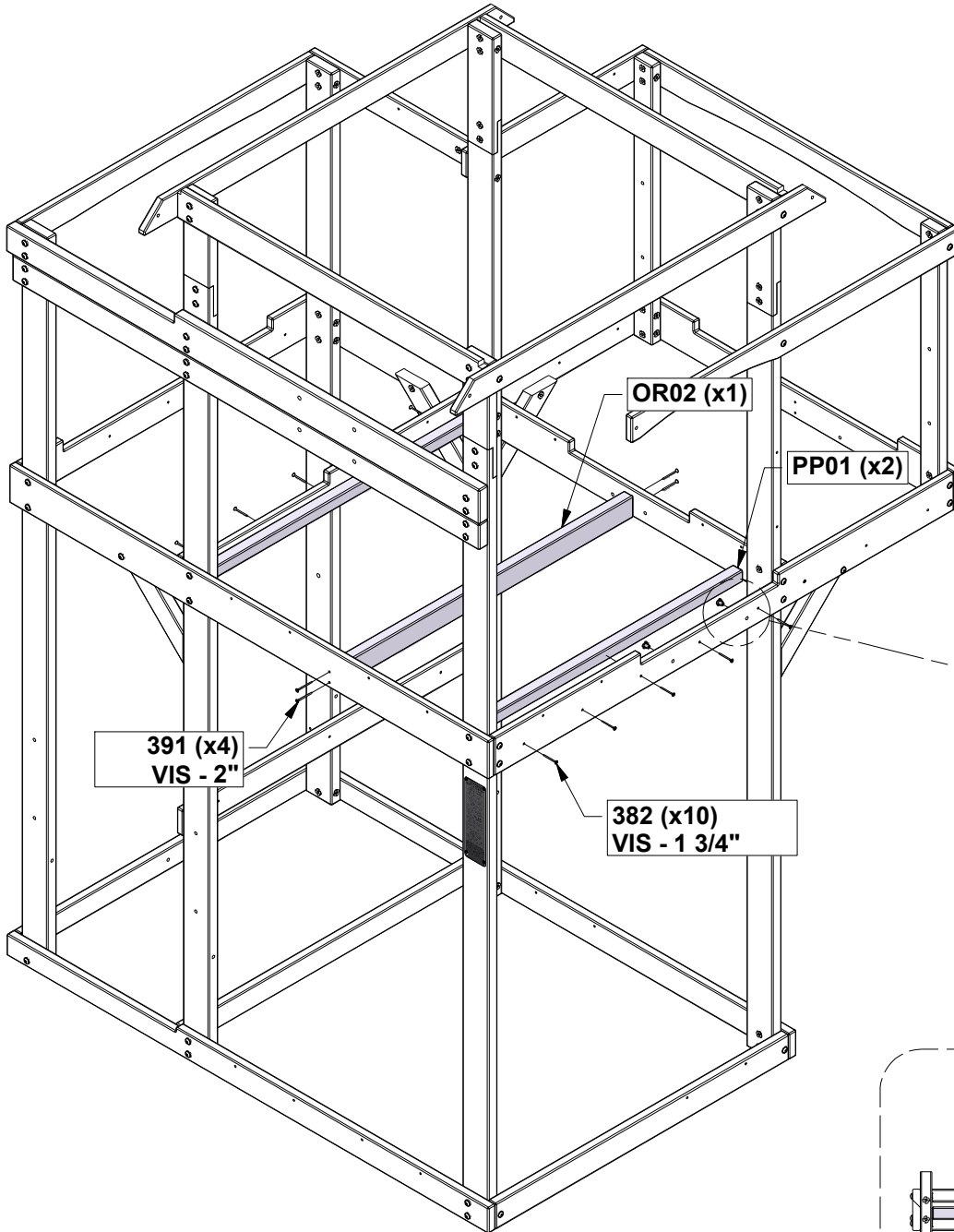

# ÉTAPE 15 - ASSEMBLAGE DE FORT

QTÉ	N° DE PIÈCE	DESCRIPTION
6	H100382	VIS PFH 8x1 3/4 BLK
2	H100391	VIS PFH 8x2 BLK
2	H100398	ÉCROU EN T 1/4 BLK
1	H100399	ÉCROU EN BARILLET WH 1/4x7/8 BLK
3	H101139	BOULON WH 1/4x7/8 BLK



**OR05 SOLIVE DE PLANCHER - W4L20995**  
(x1) 1 1/8"x2 3/8"x20 1/2" (30x60x520)

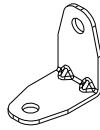

**A4M04303 SUPPORT EN L**  
(x2) 2.5x38x38x49



**PP02 PLANCHE DE SUPPORT - W4L20993**  
(x2) 1 1/4"x1 1/4"x19 1/4" (32x32x489)

**INSTALLEZ LES ÉCROUS EN T DANS LE BOIS TOUT D'ABORD**

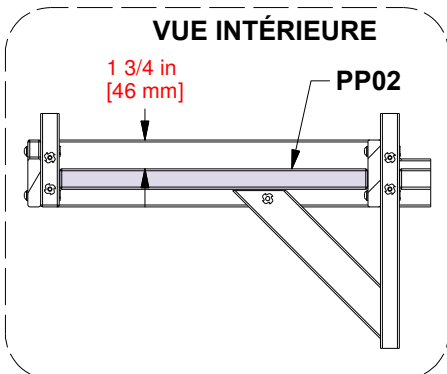
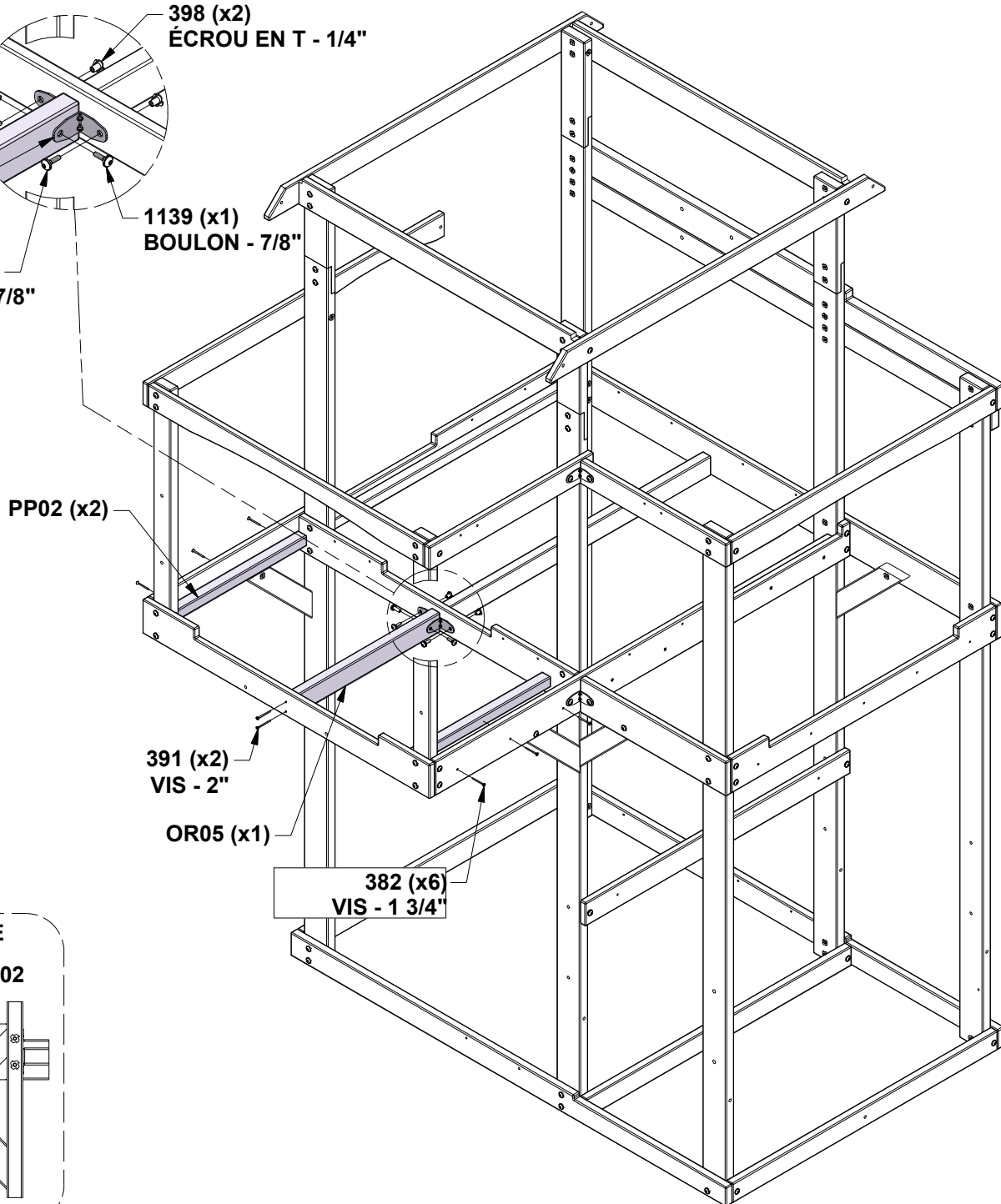
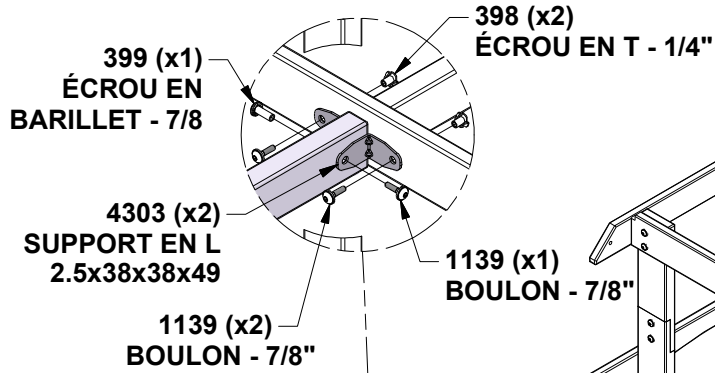

# ÉTAPE 16 - ASSEMBLAGE DE FORT

QTÉ	N° DE PIECE	DESCRIPTION
46	H100086	VIS PFH 8x1-1/2



**MS11 PLANCHER - W4L21002**  
(x8) 5/8"x3 3/4"x39" (16x96x990)

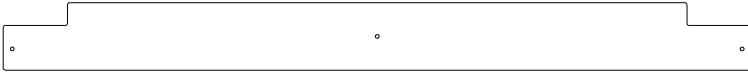

**MS12 PLANCHER - W4L21003**  
(x2) 5/8"x3 1/2"x39" (16x89x990)

## PLANCHES D'ESPACE UNIFORMÉMENT

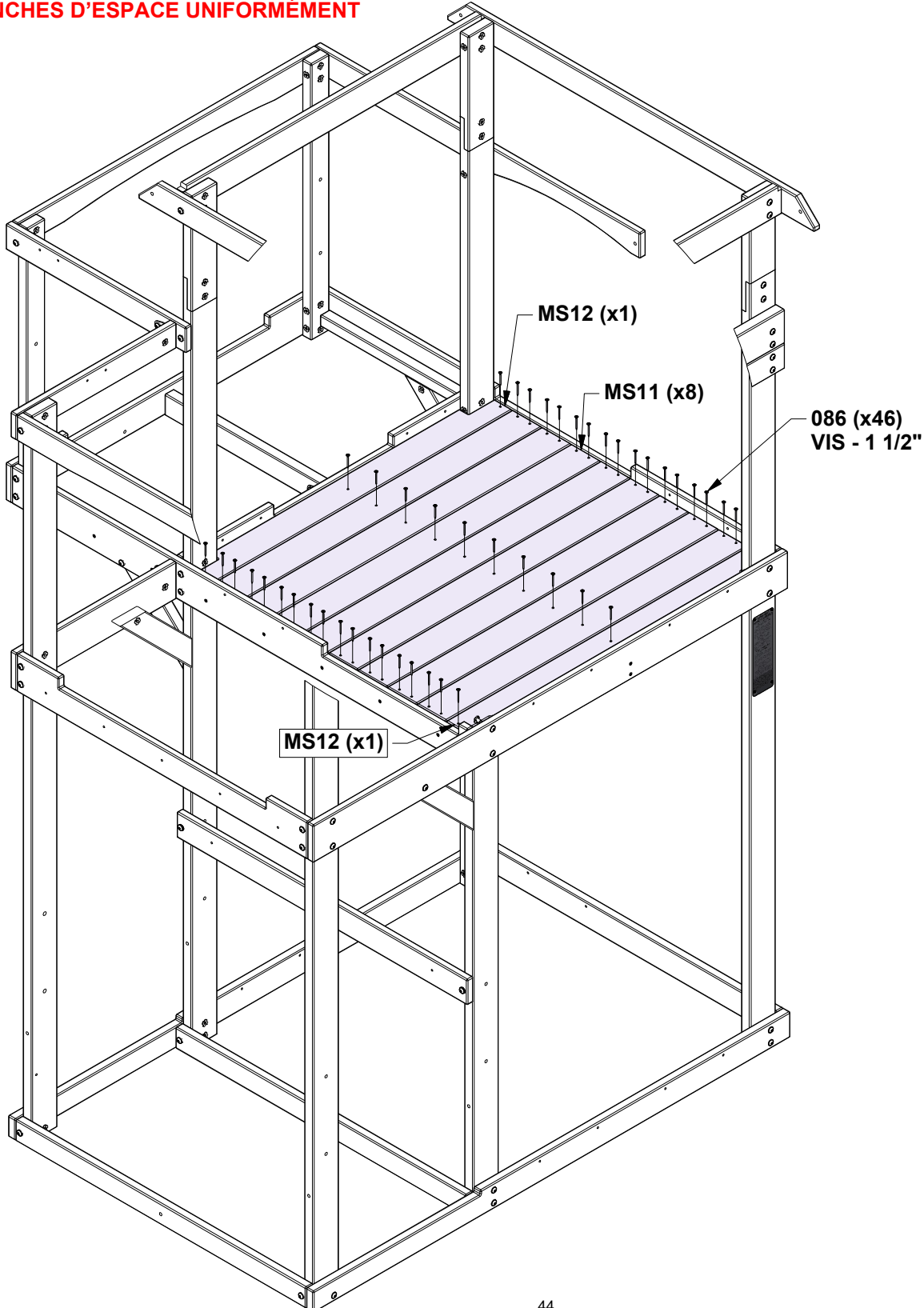

# ÉTAPE 17 - ASSEMBLAGE DE FORT

QTÉ	N° DE PIECE	DESCRIPTION
25	H100086	VIS PFH 8x1-1/2

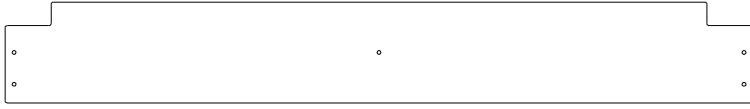

**MJ10 PLANCHER - W4L21001**  
(x1) 5/8"x5 1/4"x39" (16x133x990)

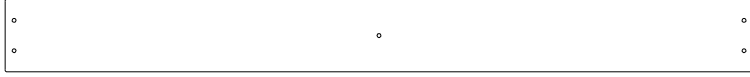

**MS11 PLANCHER - W4L21002**  
(x4) 5/8"x3 3/4"x39" (16x96x990)

## PLANCHES D'ESPACE UNIFORMÉMENT

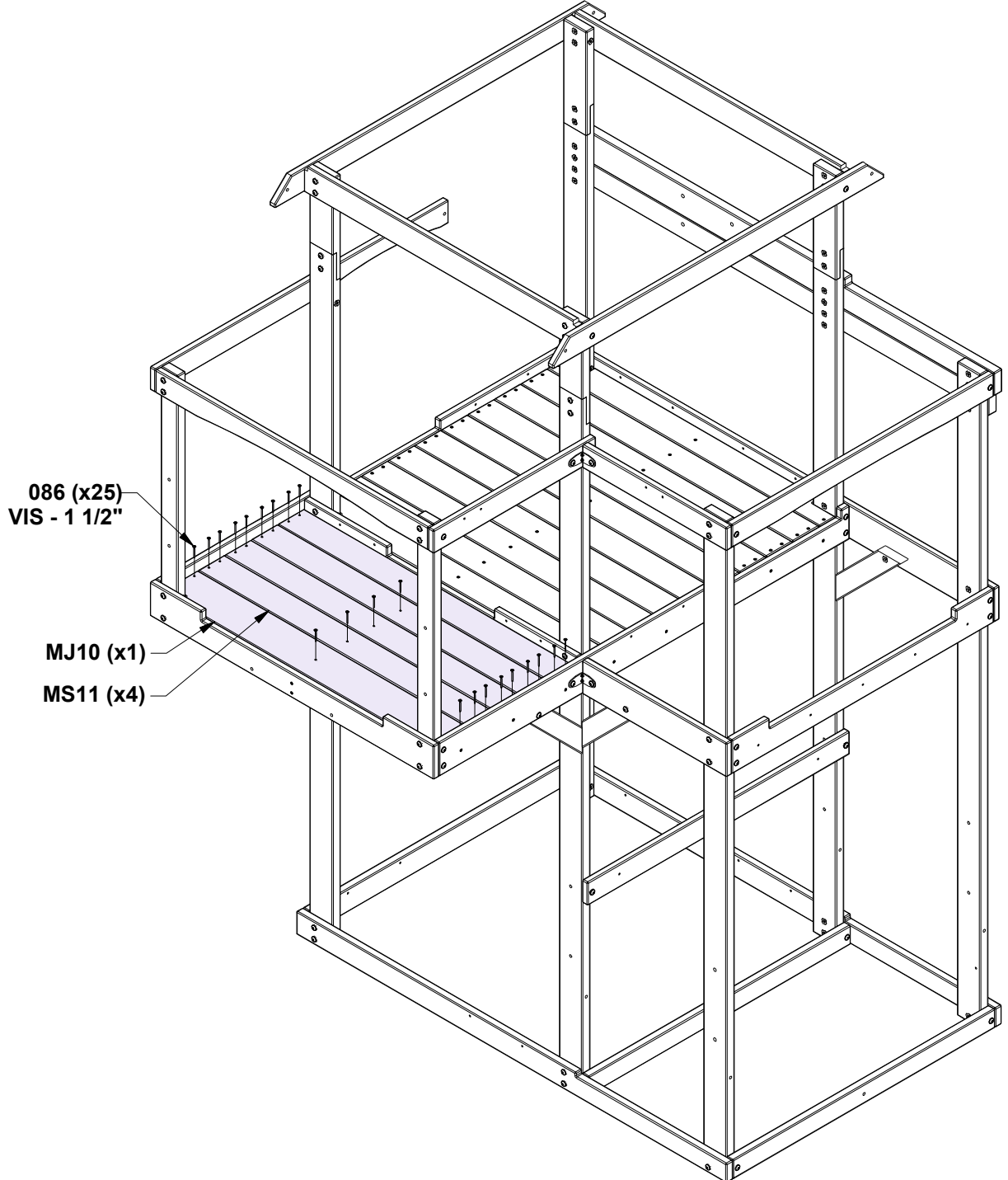

# ÉTAPE 18 - ASSEMBLAGE DE FORT

QTÉ	N° DE PIECE	DESCRIPTION
5	H100382	VIS PFH 8x1 3/4 BLK
6	H100391	VIS PFH 8x2 BLK

PP01 PLANCHE DE SUPPORT - W4L20991  
(x1) 1 1/4"x1 1/4"x35 1/8" (32x32x891)

PP03 PLANCHE DE SUPPORT - W4L20992  
(x1) 1 1/4"x1 1/4"x35" (32x32x890)

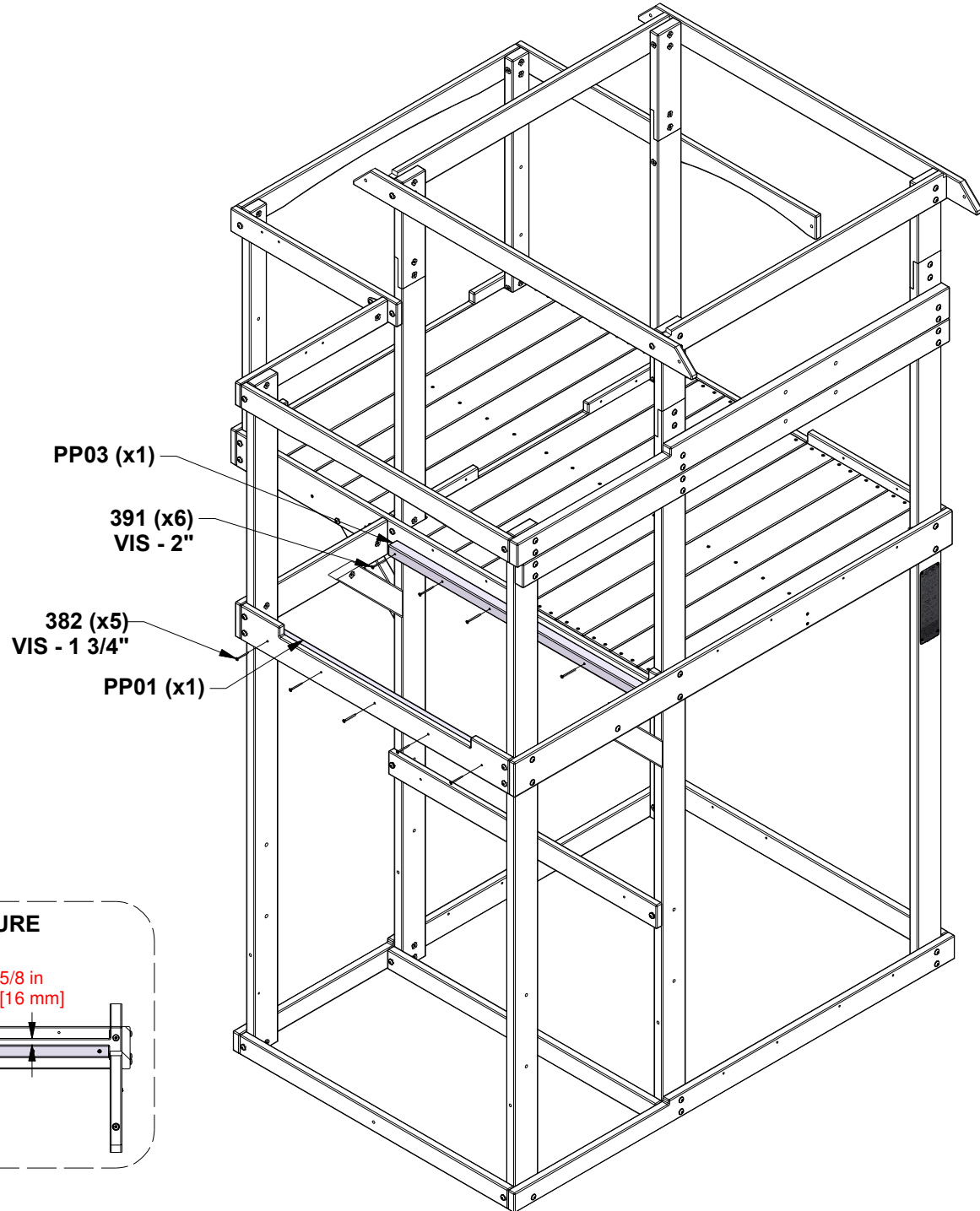

## VUE INTÉRIEURE

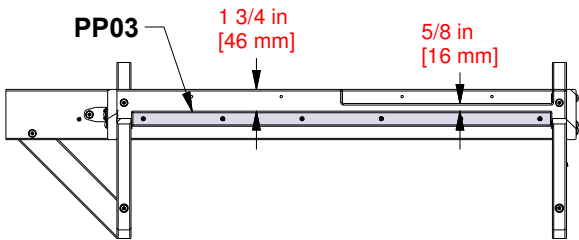

# ÉTAPE 19 - ASSEMBLAGE DE FORT

QTÉ	N° DE PIECE	DESCRIPTION
36	H100086	VIS PFH 8x1-1/2

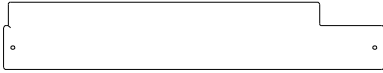

**MS08 PLANCHER - W4L20999**  
(x2) 5/8"x3 1/2"x19 3/4" (16x89x503)



**MS09 PLANCHER - W4L21000**  
(x8) 5/8"x3 3/4"x19 3/4" (16x96x503)

## PLANCHES D'ESPACE UNIFORMÉMENT

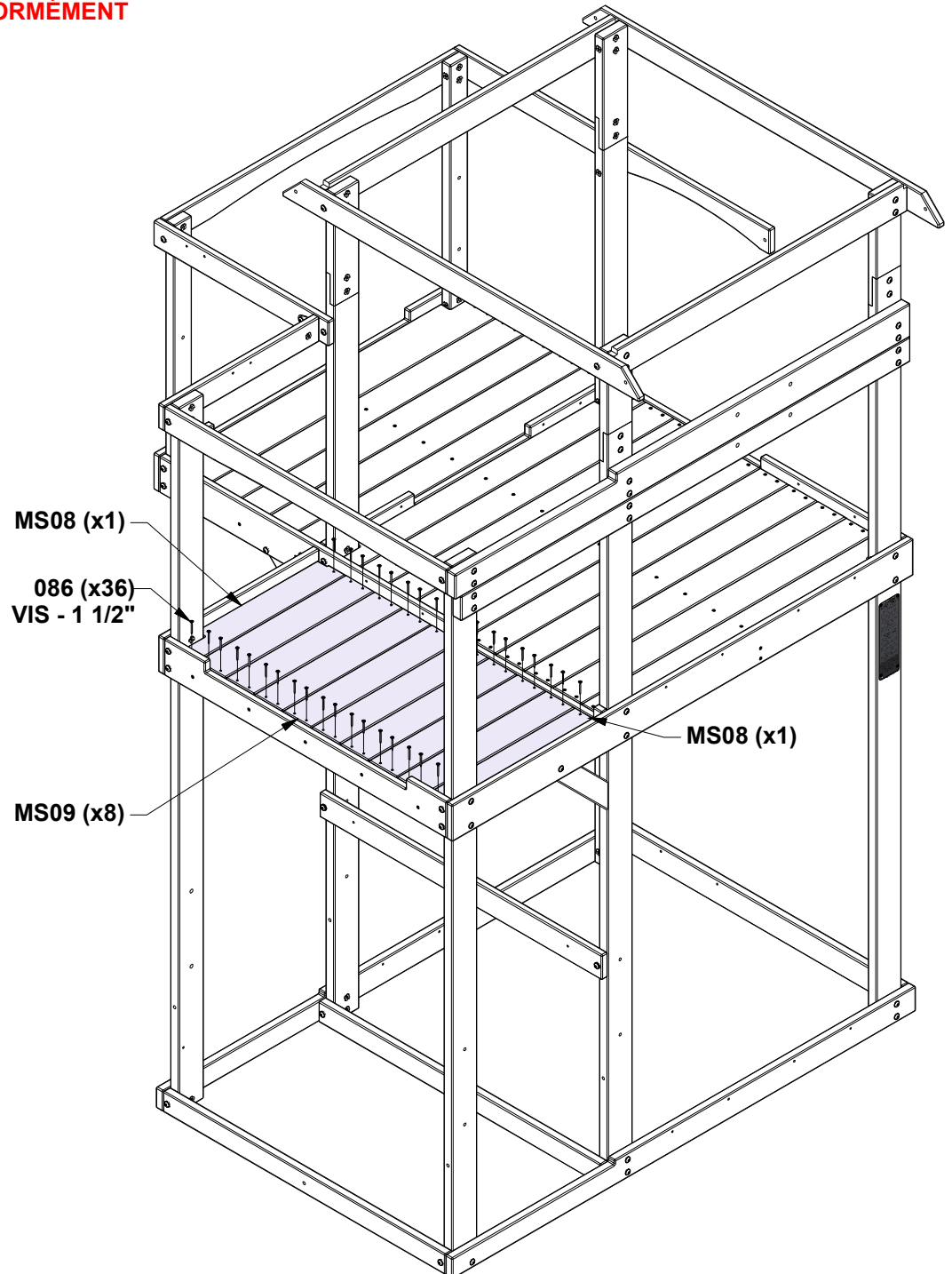

# ÉTAPE 20 - ASSEMBLAGE DE FORT

QTÉ	N° DE PIECE	DESCRIPTION
2	H100405	RONDELLE D'ARRET EXT 6x15 BLK
2	H101026	BOULON WH 1/4x1-3/4 BLK

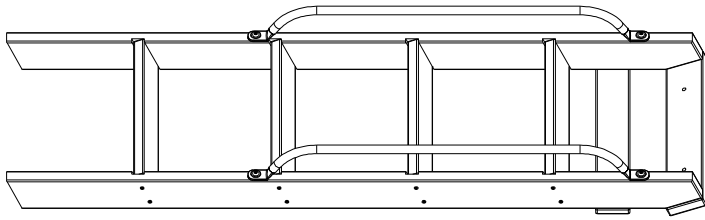

ENSEMBLE ÉCHELLE

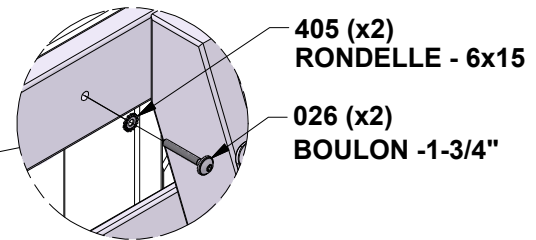
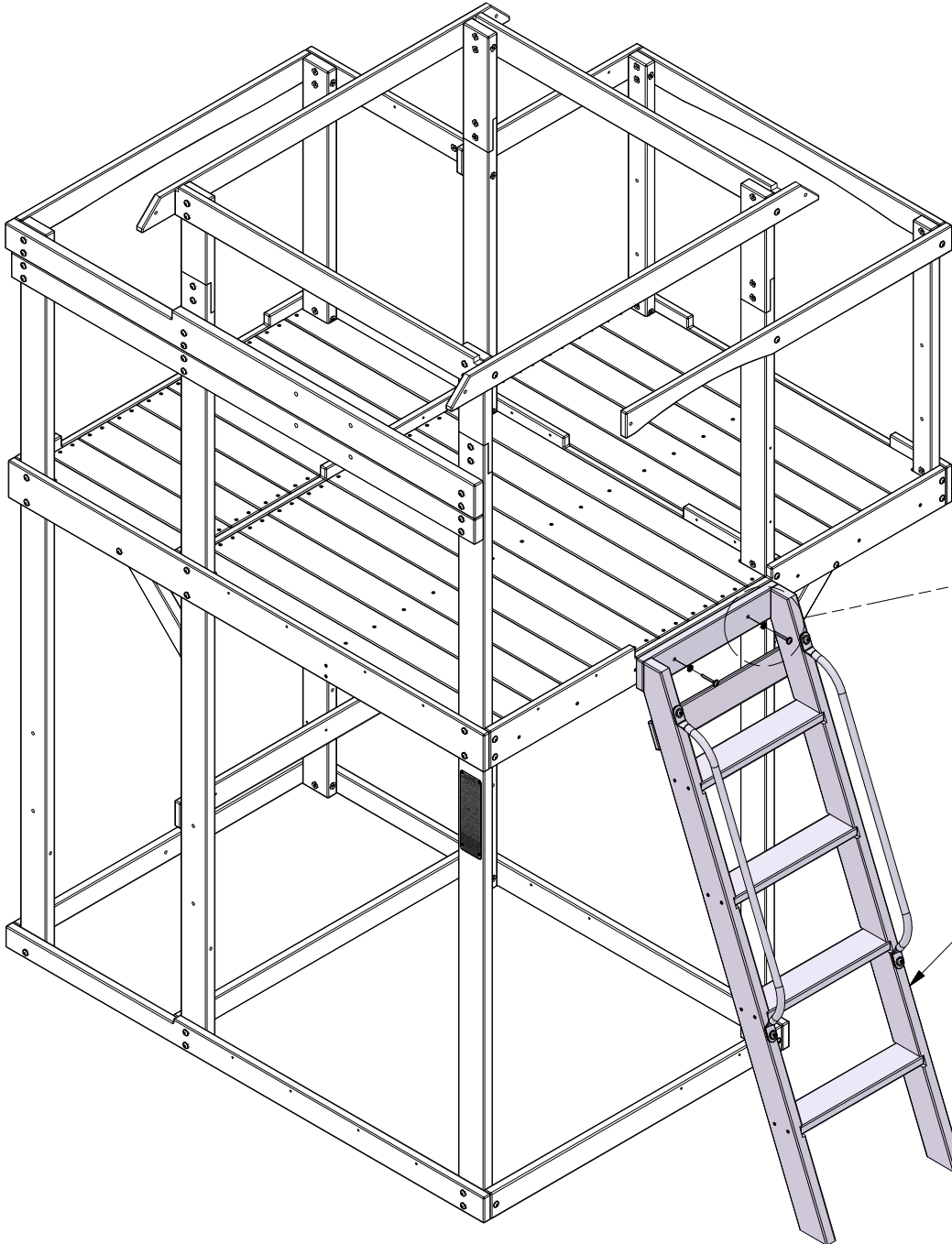

ENSEMBLE ÉCHELLE

# ÉTAPE 21 - ASSEMBLAGE DE FORT

QTÉ	N° DE PIÈCE	DESCRIPTION
3	H100200	VIS PFH 8x1-1/2 BLK
4	H100382	VIS PFH 8x1 3/4 BLK

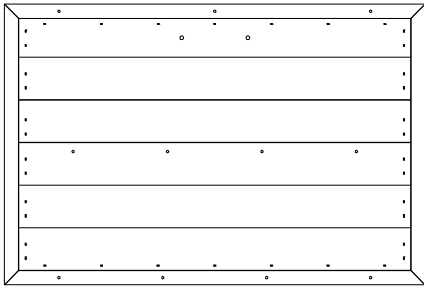

**WP01 PANNEAU MURAL - W2A04238**  
 (x1) 1"x20 3/8"x37 3/4" (24x593x891)

## VUE INTÉRIEURE

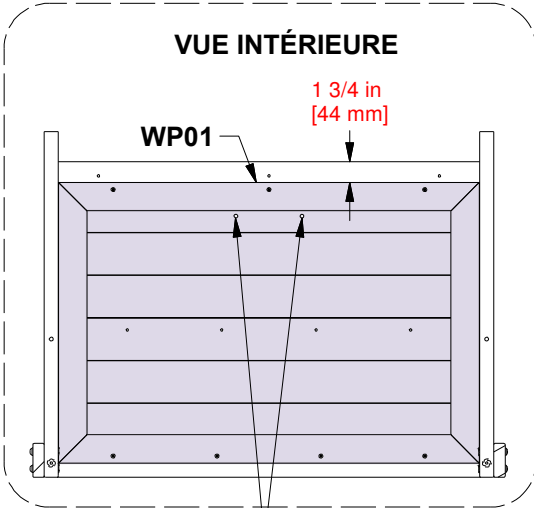

**TROUS  
VERS LE HAUT**

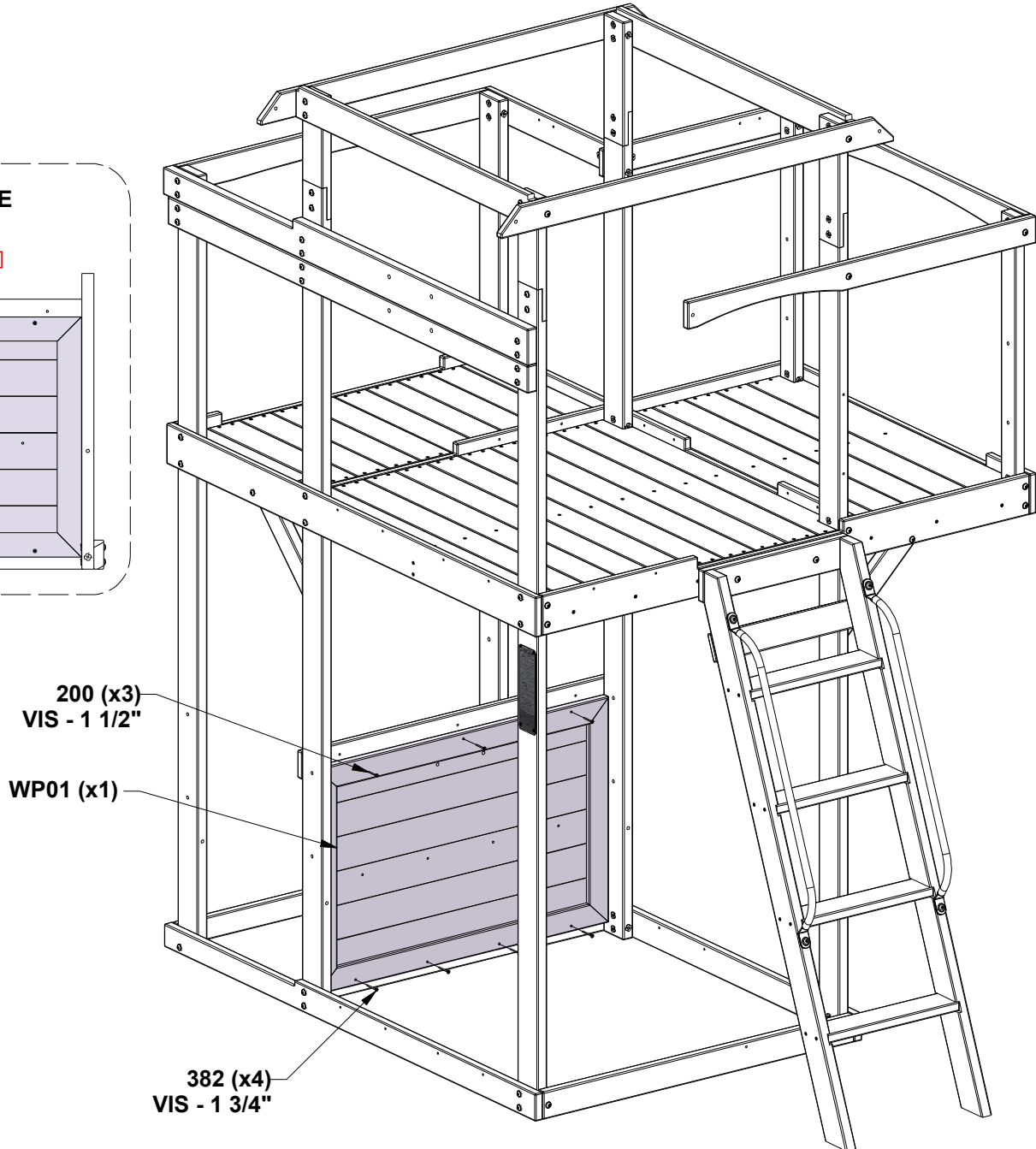

# ÉTAPE 22 - ASSEMBLAGE DE FORT

QTÉ	N° DE PIECE	DESCRIPTION
3	H100200	VIS PFH 8x1-1/2 BLK



HC04 PLANCHE DE SUPPORT - W4L21005  
(x1) 1"x1 1/8"x35 1/8" (24x28x891)

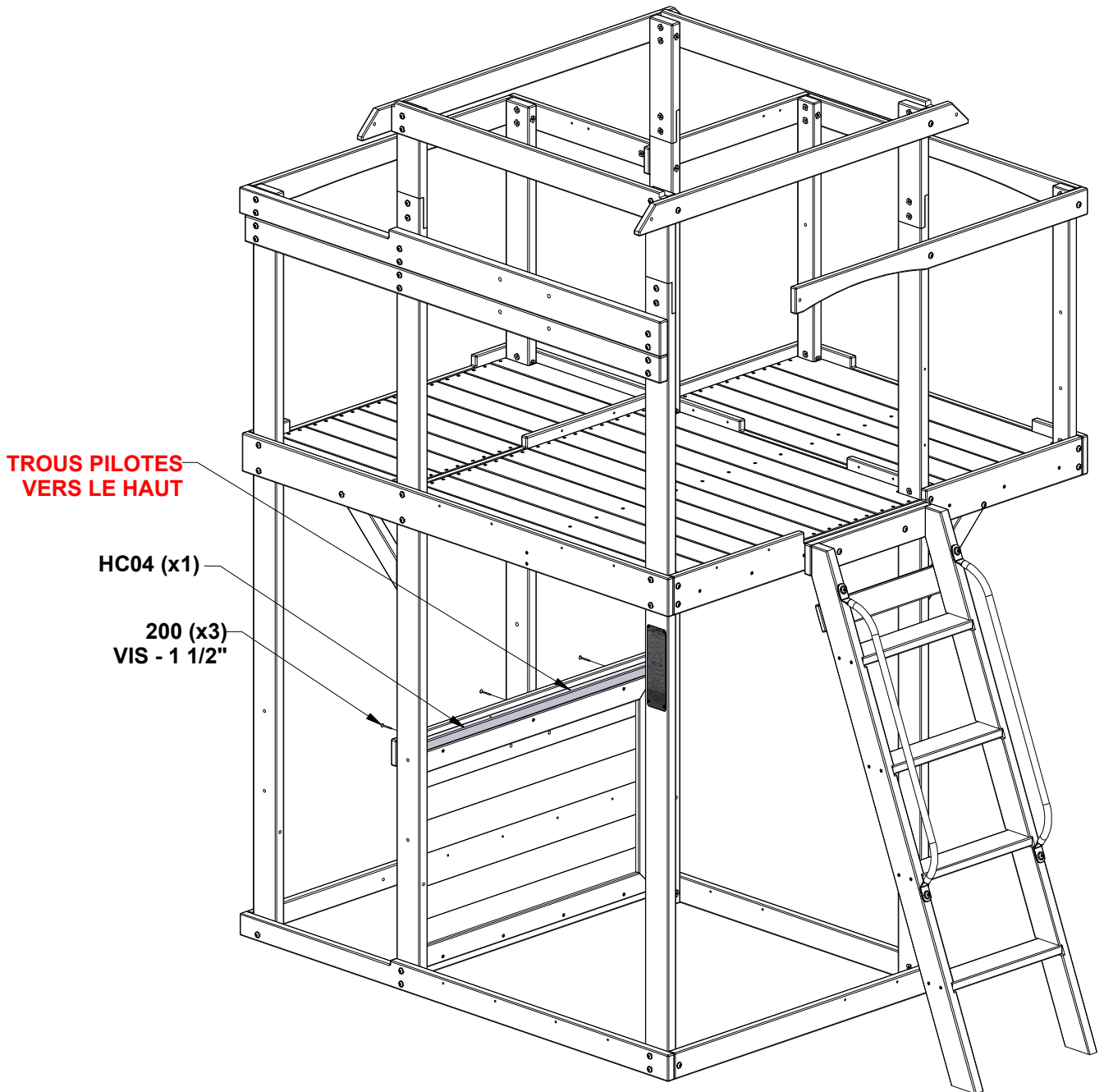

# ÉTAPE 23 - ASSEMBLAGE DE FORT

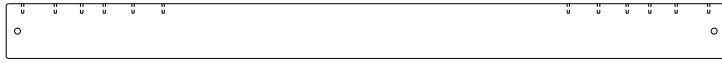

**HB07** SUPPORT DE SIÈGE - W4L19930  
(x1) 1"x2 7/8"x37 1/2" (24x72x952)

QTÉ	N° DE PIÈCE	DESCRIPTION
4	H100088	VIS PFH 8x1-1/8
2	H100398	ÉCROU EN T 1/4 BLK
2	H100405	RONDELLE D'ARRET EXT 6x15 BLK
2	H101174	BOULON WH 1/4x4 1/4 BLK

**INSTALLEZ LES ÉCROUS EN T DANS LE BOIS TOUT D'ABORD**

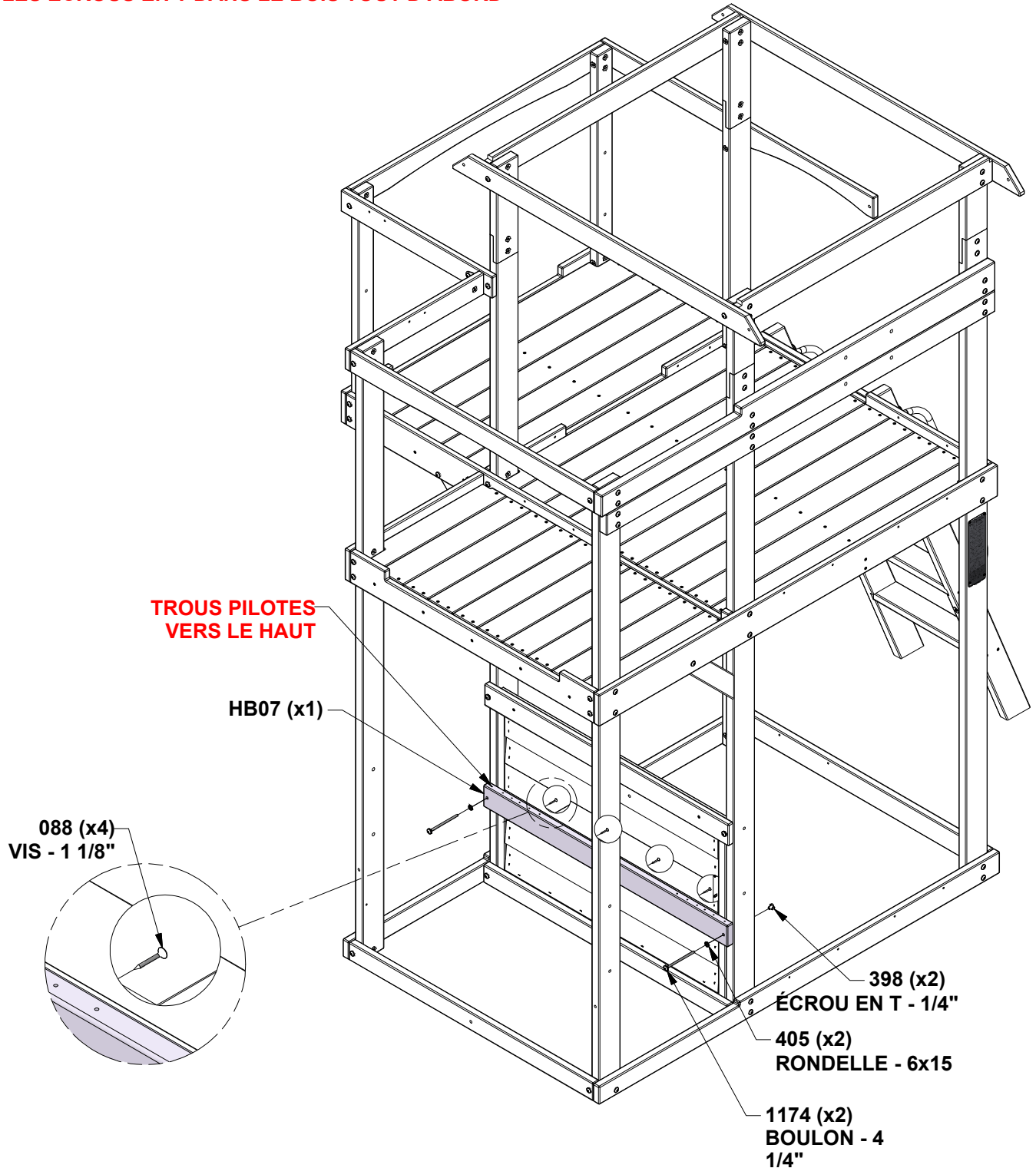

# ÉTAPE 24 - ASSEMBLAGE DE FORT



**OG12 SUPPORT DE TABLE - W4L20975**  
(x1) 1 1/8"x3 1/4"x22 3/8" (30x84x567)



**HR07 BLOC DE SUPPORT - W4L20987**  
(x1) 1"x2 3/8"x3 1/4" (24x60x84)

QTÉ	N° DE PIÈCE	DESCRIPTION
1	H100398	ÉCROU EN T 1/4 BLK
1	H100405	RONDELLE D'ARRET EXT 6x15 BLK
1	H100800	BOULON WH 1/4x3 BLK

**INSTALLEZ LES ÉCROUS EN T DANS LE BOIS TOUT D'ABORD**

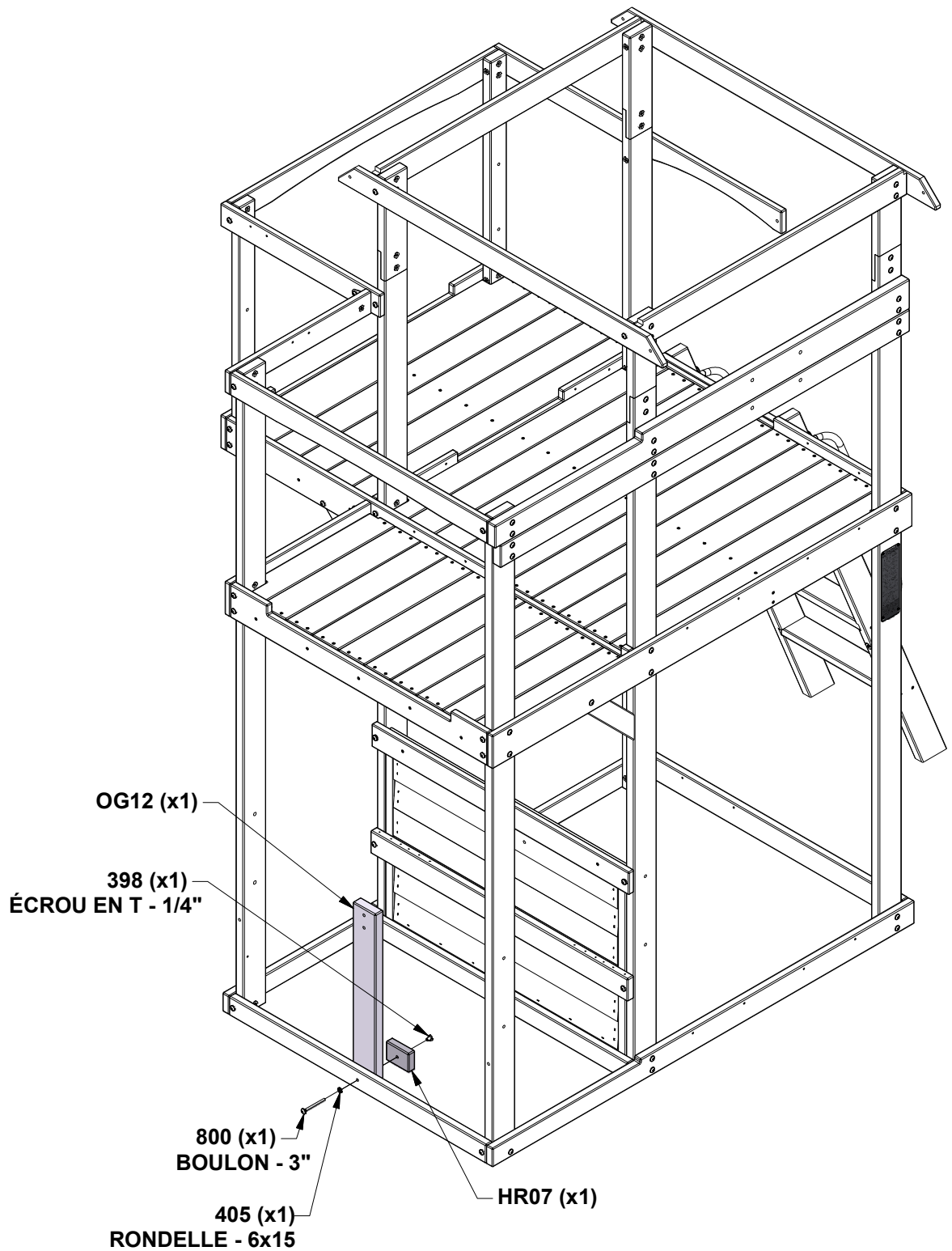

# ÉTAPE 25 - ASSEMBLAGE DE FORT

QTÉ	N° DE PIECE	DESCRIPTION
40	H100086	VIS PFH 8x1-1/2



**MJ01** PLANCHER - W4L20988  
(x2) 5/8"x5"x21 1/2" (16x126x547)



**MG05** PLANCHER - W4L20990  
(x2) 5/8"x3 1/4"x21 1/2" (16x84x547)



**MS04** PLANCHER - W4L20989  
(x6) 5/8"x3 3/4"x21 1/2" (16x96x547)

## PLANCHES D'ESPACE UNIFORMÉMENT

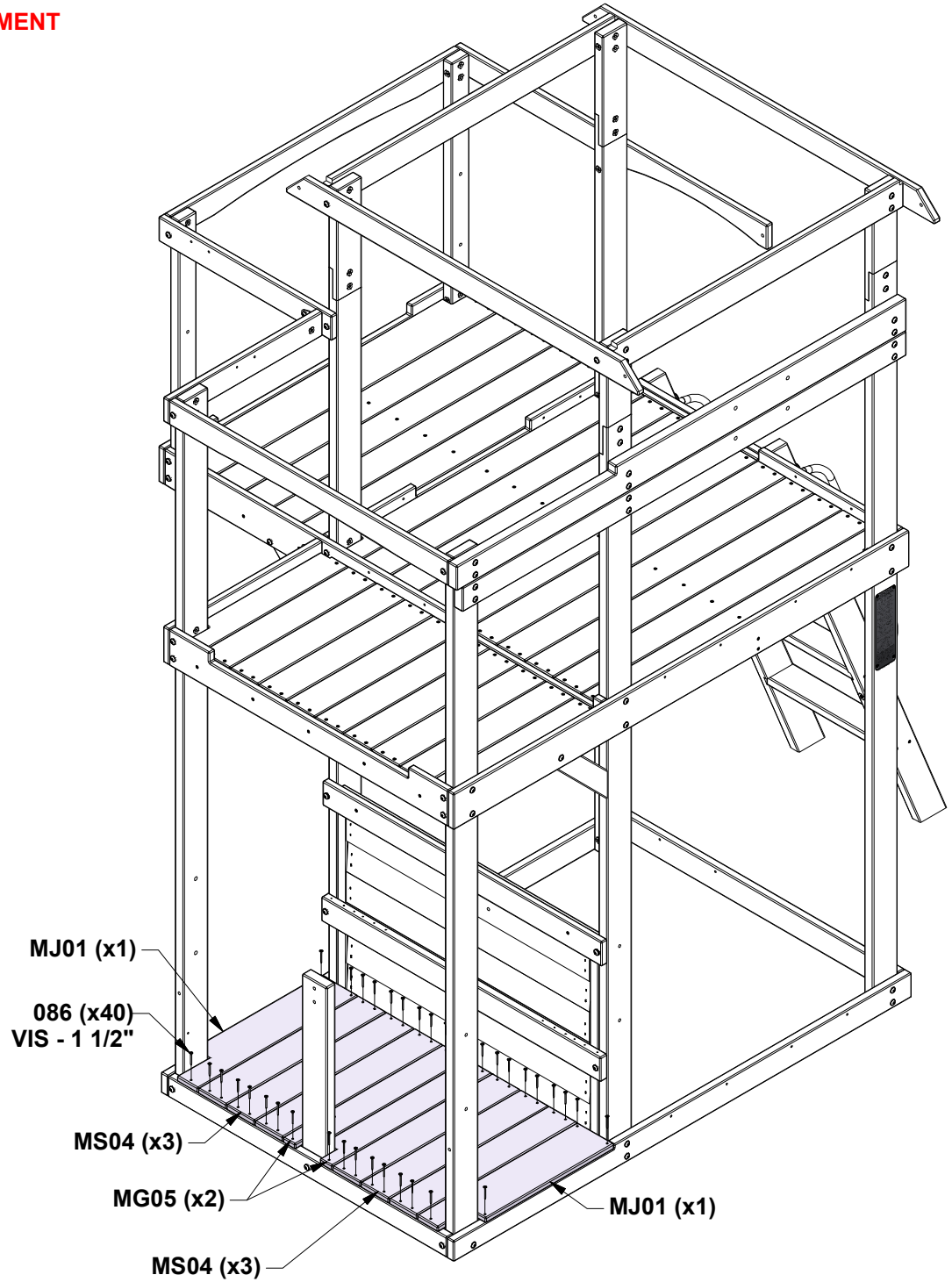

# ÉTAPE 26 - ASSEMBLAGE DE FORT

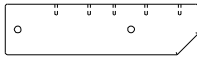

**HR03 SUPPORT DE BANC - W4L20978**  
(x2) 1"x2 3/8"x9" (24x60x230)



**OR07 SUPPORT À L'ANGLE - W4L20979**  
(x2) 1 1/8"x2 3/8"x10" (30x60x254)

QTÉ	N° DE PIÈCE	DESCRIPTION
4	H100398	ÉCROU EN T 1/4 BLK
6	H100405	RONDELLE D'ARRET EXT 6x15 BLK
2	H100487	TIREFOND WH 1/4x2 BLK
2	H100488	BOULON WH 1/4x2 BLK
2	H101174	BOULON WH 1/4x4 1/4 BLK

**INSTALLEZ LES ÉCROUS EN T DANS LE BOIS TOUT D'ABORD**

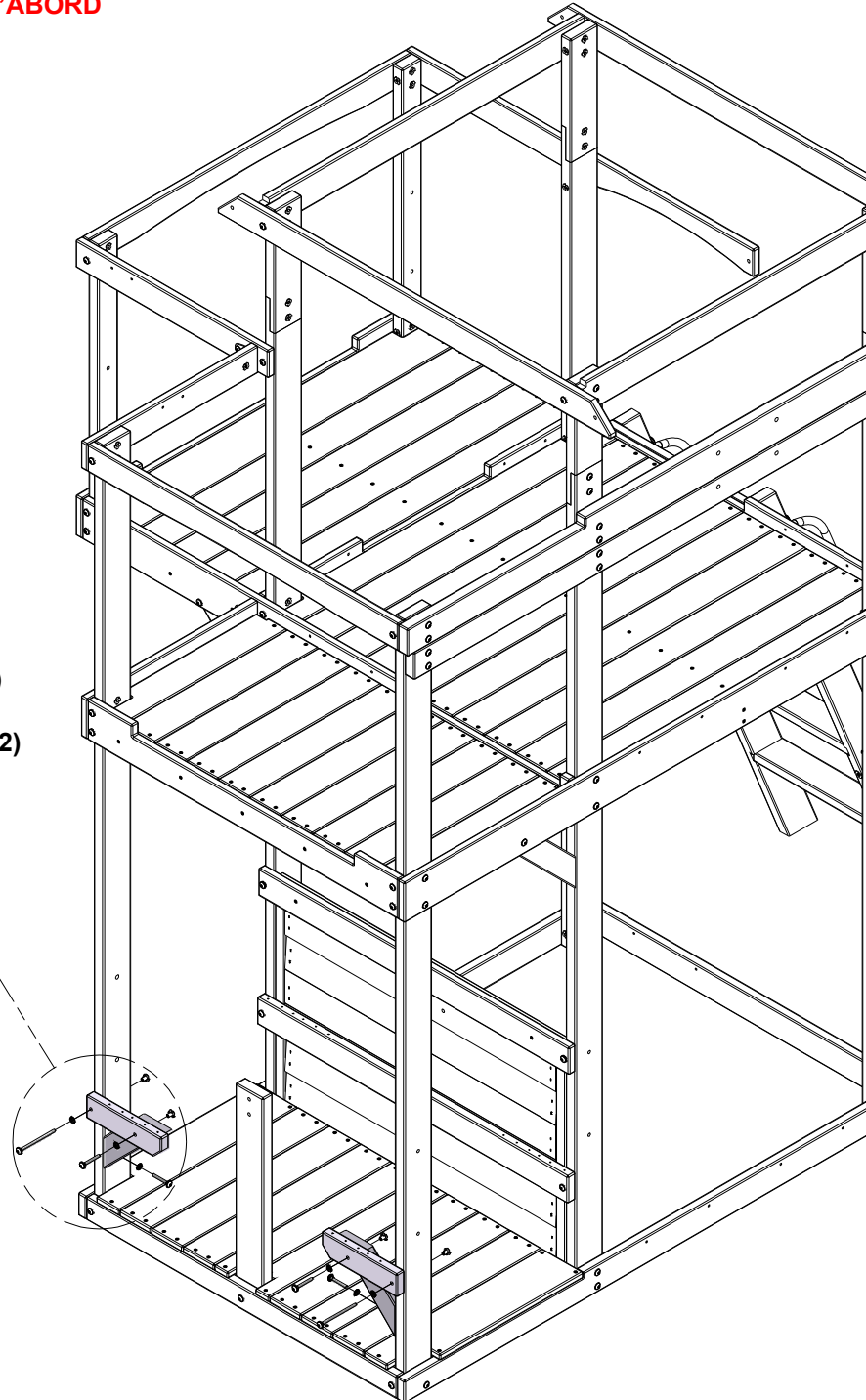
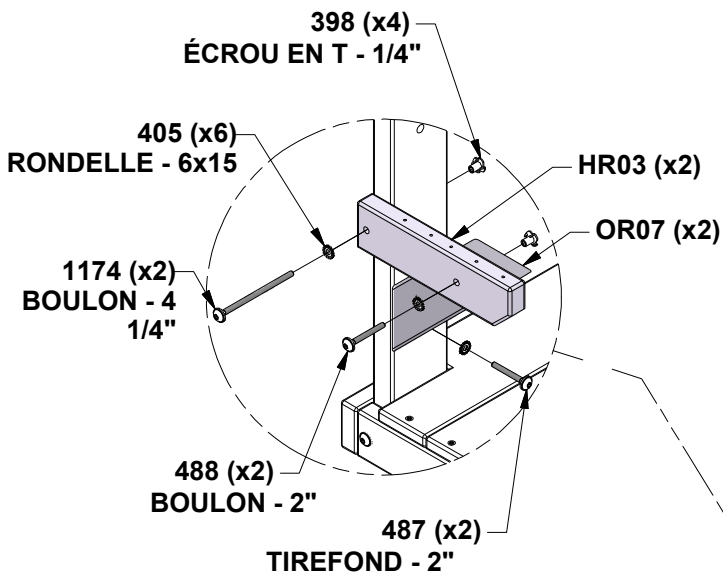

# ÉTAPE 27 - ASSEMBLAGE DE FORT

QTÉ	N° DE PIÈCE	DESCRIPTION
22	H100111	VIS PFH 8x2



**HG05 BANQUETTE - W4L20983**  
(x2) 1"x3 1/4"x21 5/8" (24x84x548)



**HR01 BANQUETTE - W4L20984**  
(x2) 1"x2 3/8"x21 5/8" (24x60x548)



**HG06 BANQUETTE - W4L20985**  
(x2) 1"x3 1/4"x21 5/8" (24x84x548)

## PLANCHES D'ESPACE UNIFORMÉMENT

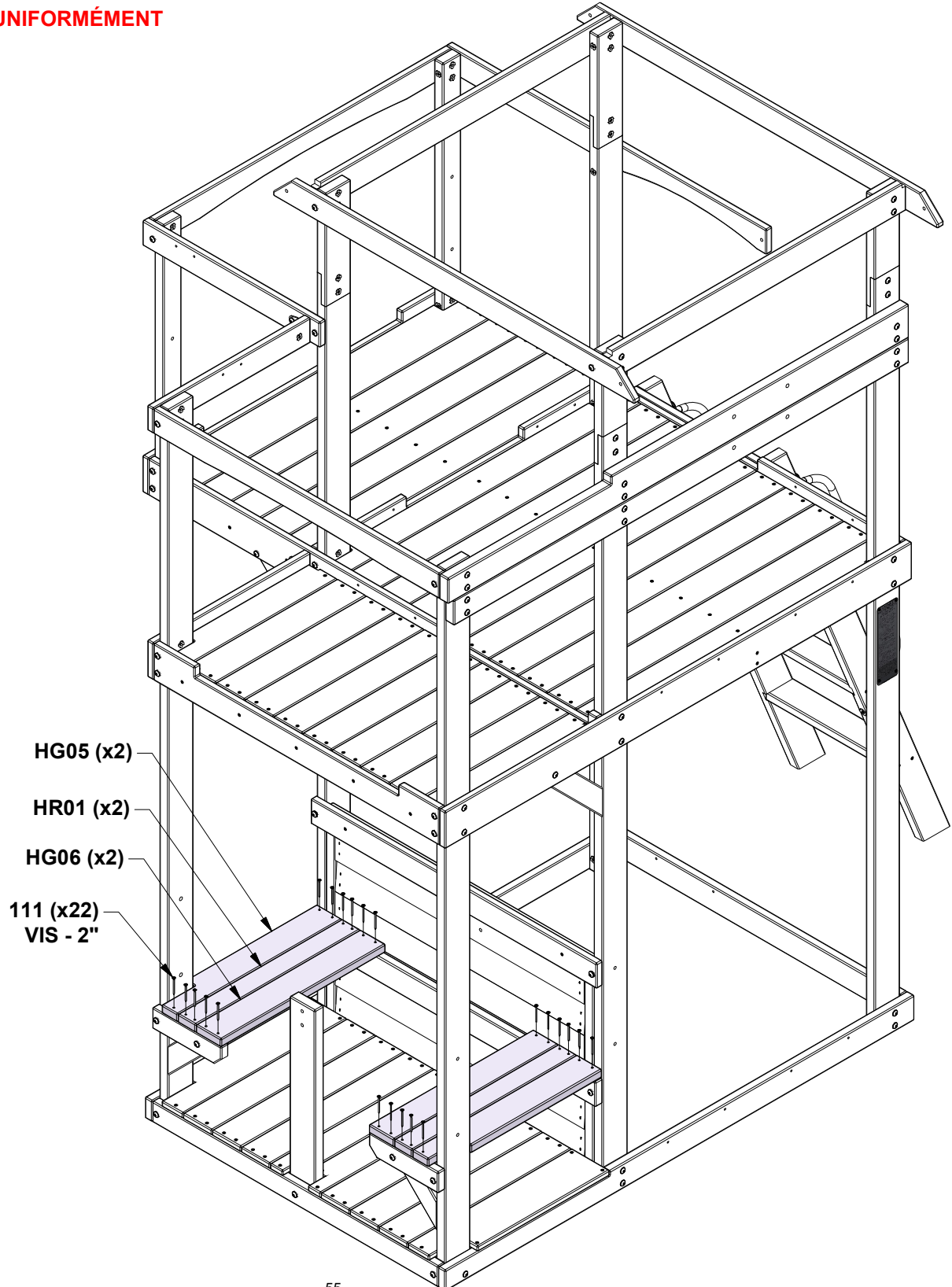

# ÉTAPE 28 - ASSEMBLAGE DE FORT

QTÉ	N° DE PIÈCE	DESCRIPTION
12	H100111	VIS PFH 8x2
4	H100398	ÉCROU EN T 1/4 BLK
4	H100405	RONDELLE D'ARRÊT EXT 6x15 BLK
2	H100406	BOULON WH 1/4x1 1/2 BLK
2	H100488	BOULON WH 1/4x2 BLK

**HG03** SUPPORT DE TABLE - W4L20976  
(x1) 1"x3 1/4"x12 3/8" (24x84x313)

**HJ01** PANNEAU DE TABLE - W4L20986  
(x1) 1"x5 5/8"x21 5/8" (24x144x548)

**HG06** BANQUETTE - W4L20985  
(x2) 1"x3 1/4"x21 5/8" (24x84x548)

**OO04** SUPPORT DE TABLE - W4L20977  
(x1) 1 1/8"x1 1/8"x12 3/8" (30x30x313)

**INSTALLEZ LES ÉCROUS EN T DANS LE BOIS TOUT D'ABORD**

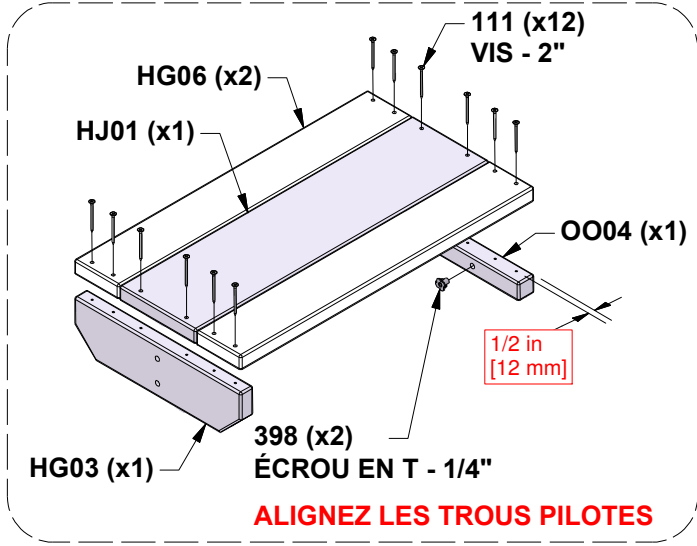

406 (x2)  
BOULON - 1 1/2"

405 (x2)  
RONDELLE - 6x15

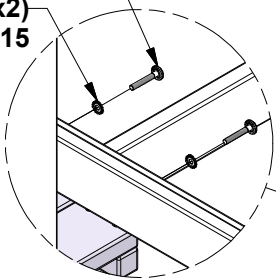

398 (x2)  
ÉCROU EN T - 1/4"

488 (x2)  
BOULON - 2"

405 (x2)  
RONDELLE - 6x15

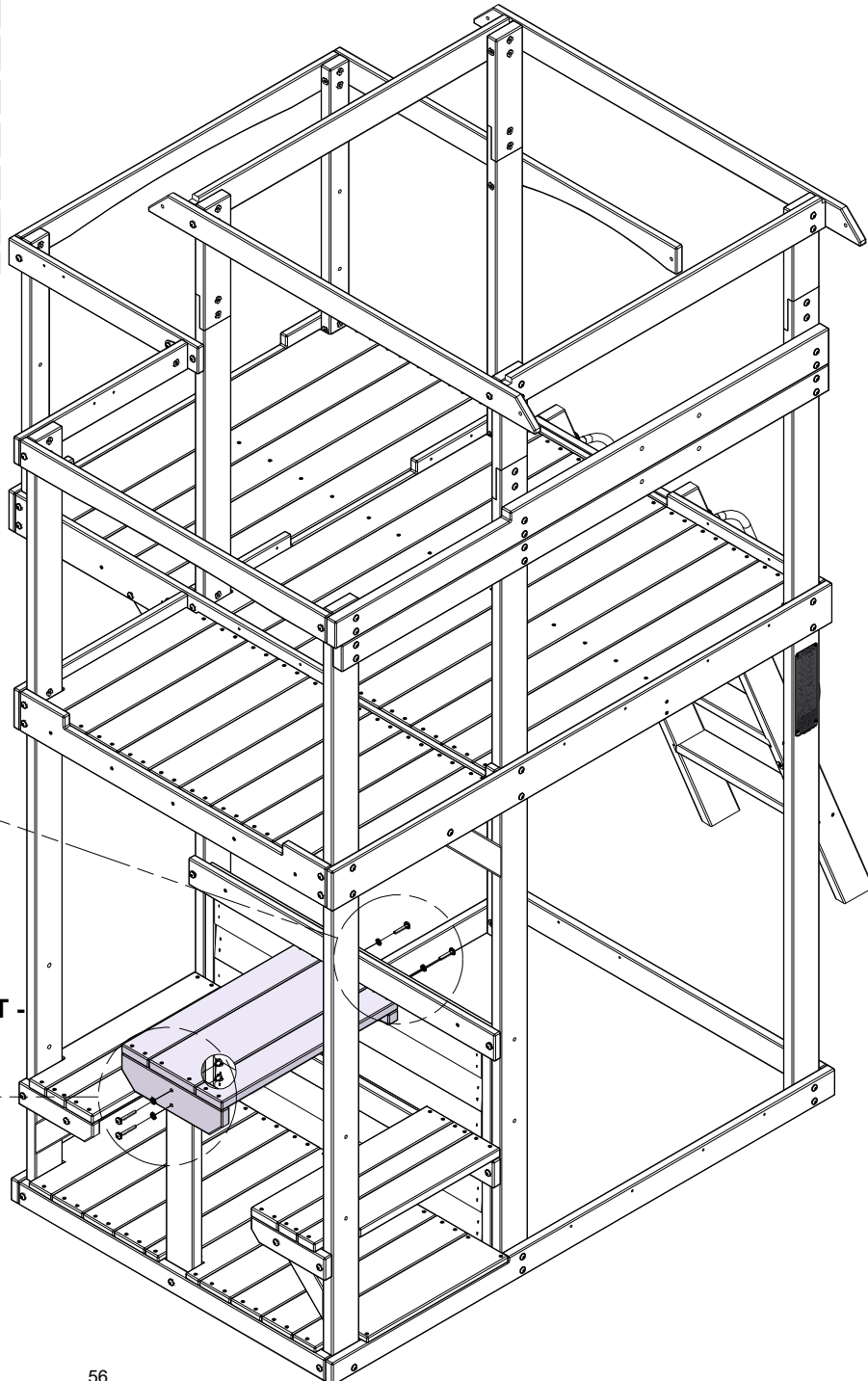
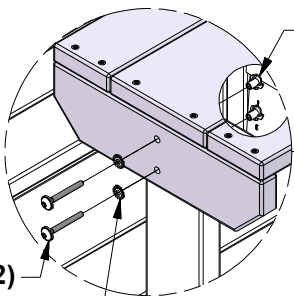

# ÉTAPE 29 - ASSEMBLAGE DE FORT

QTÉ	N° DE PIÈCE	DESCRIPTION
16	H100202	VIS PWH 8x5/8 BLK
4	H100382	VIS PFH 8x1 3/4 BLK

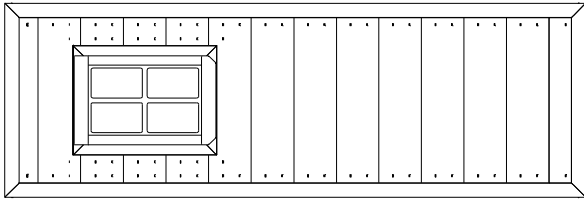

**WP02 PANNEAU MURAL - W2A04239**  
(x2) 1 5/8"x18 3/4"x40" (36x410x1230)

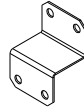

**A4M04561 SUPPORT**  
(x4)

## VUE INTÉRIEURE

**4561 SUPPORT**

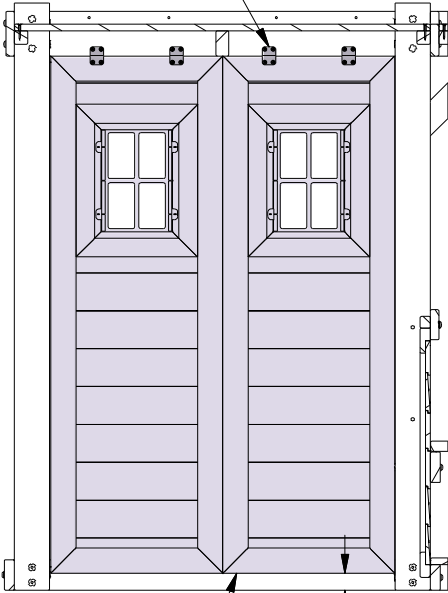

**WP02**

1 5/8 in  
[40 mm]

**202 (x16)  
VIS - 5/8"**

**4561 (x4)  
SUPPORT**

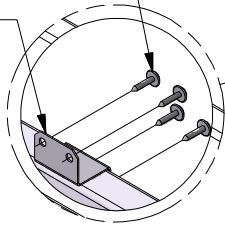

**382 (x4)  
VIS - 1 3/4"**

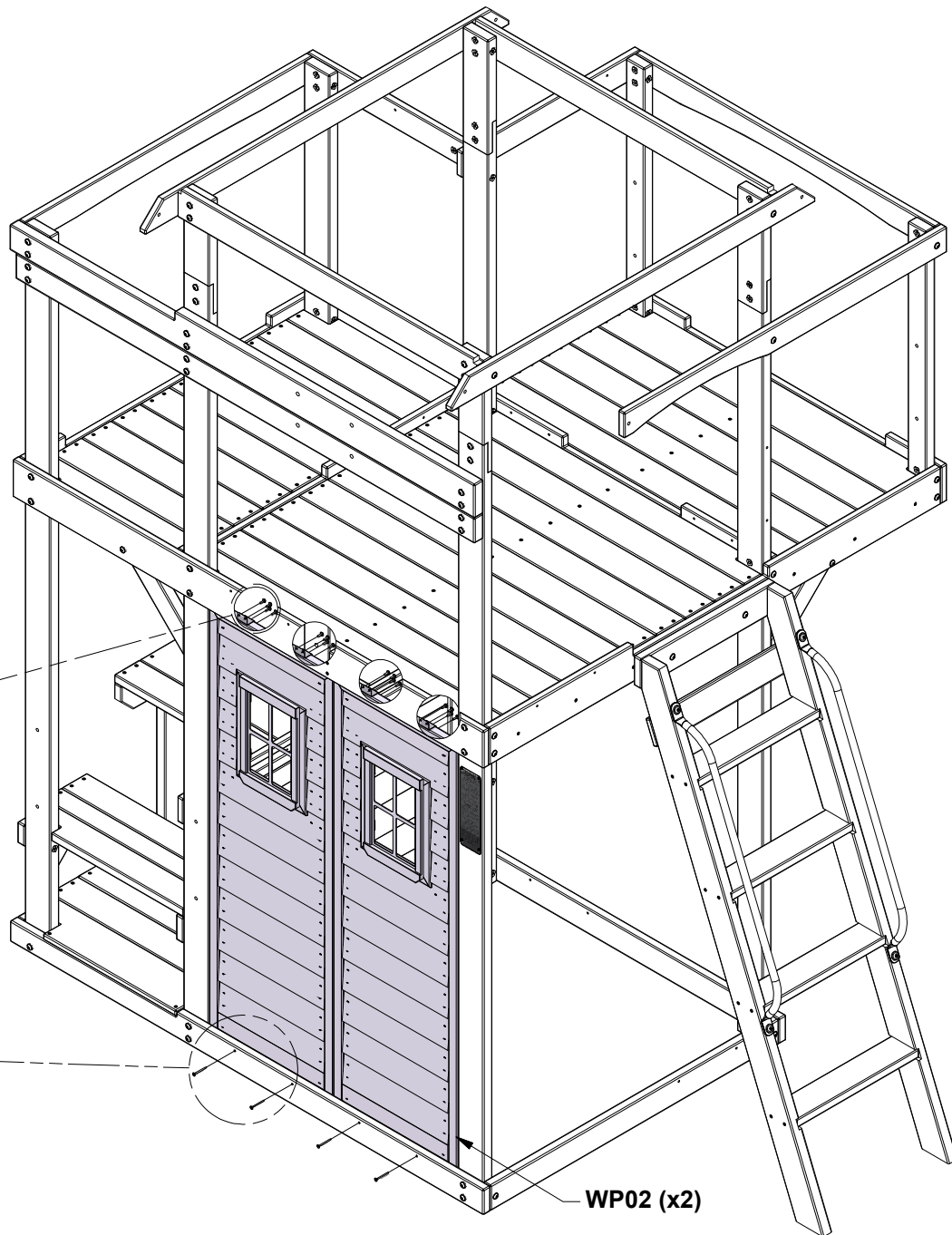
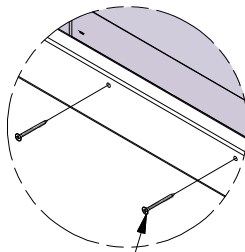

**WP02 (x2)**

# ÉTAPE 30 - ASSEMBLAGE DE FORT

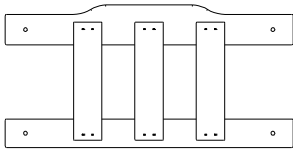

**WP07 DOSSIER DE BANC - W2A04240**  
(x1) 1 1/8"x11 7/8"x24 1/4" (28x301x610)

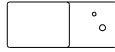

**OR08 BLOC DE SUPPORT - W4L20996**  
(x1) 1 1/8"x2 3/8"x5 3/4" (30x60x145)

QTÉ	N° DE PIÈCE	DESCRIPTION
1	H100391	VIS PFH 8x2 BLK
4	H100398	ÉCROU EN T 1/4 BLK
4	H100405	RONDELLE D'ARRET EXT 6x15 BLK
3	H101026	BOULON WH 1/4x1-3/4 BLK
1	H101376	BOULON WH 1/4x2 3/4 BLK

**INSTALLEZ LES ÉCROUS EN T DANS LE BOIS TOUT D'ABORD**

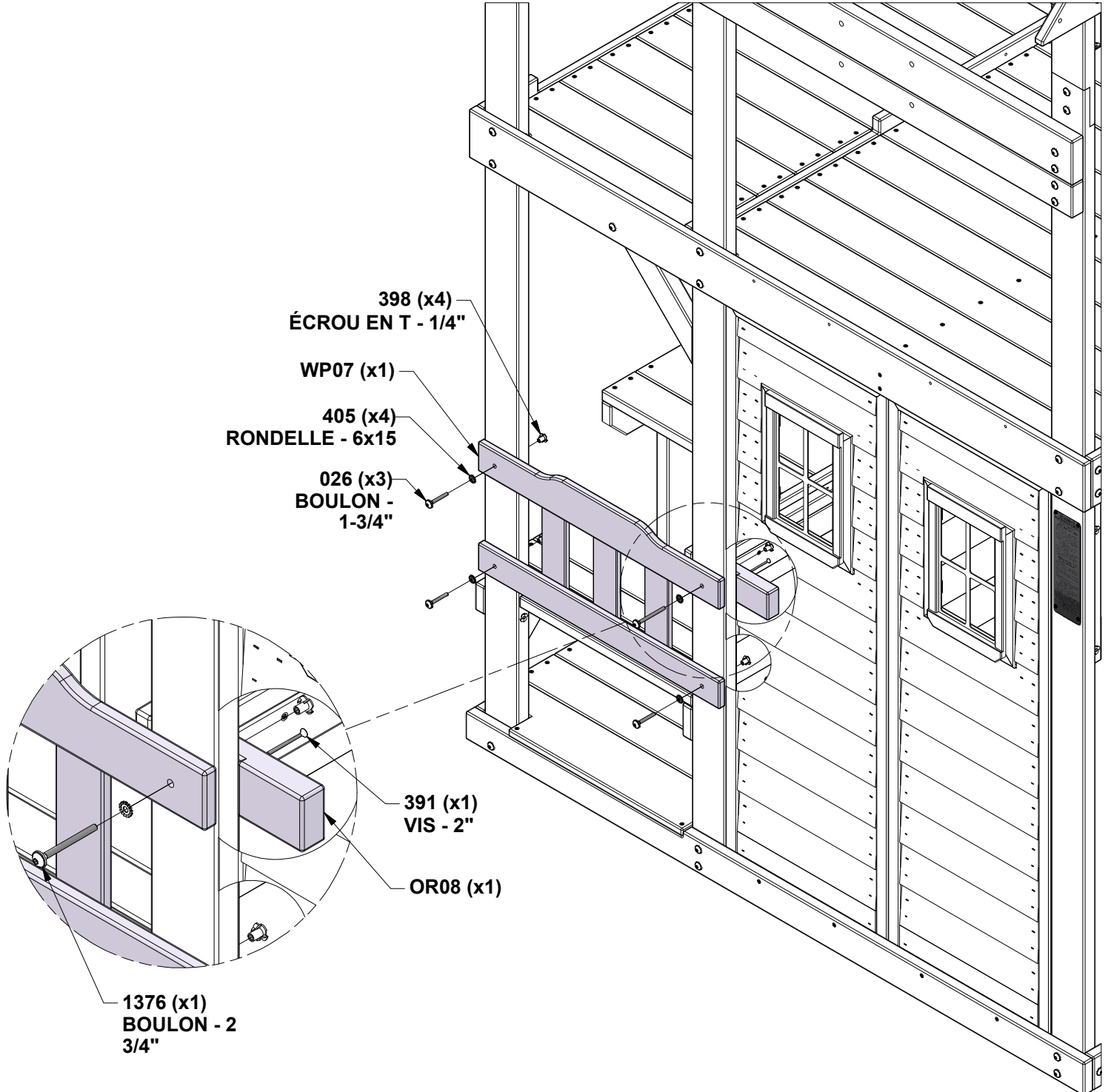

# ÉTAPE 31 - ASSEMBLAGE DE FORT

QTÉ	N° DE PIÈCE	DESCRIPTION
8	H100202	VIS PWH 8x5/8 BLK
2	H100382	VIS PFH 8x1 3/4 BLK

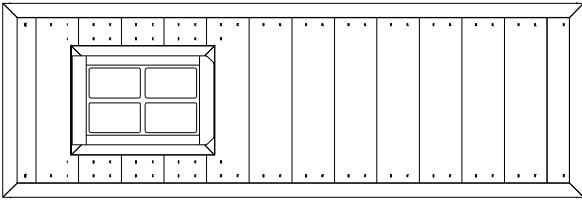

**WP02 PANNEAU MURAL - W2A04239**  
(x1) 1 5/8"x18 3/4"x40" (36x410x1230)

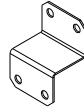

**A4M04561 SUPPORT**  
(x2)

## VUE INTÉRIEURE

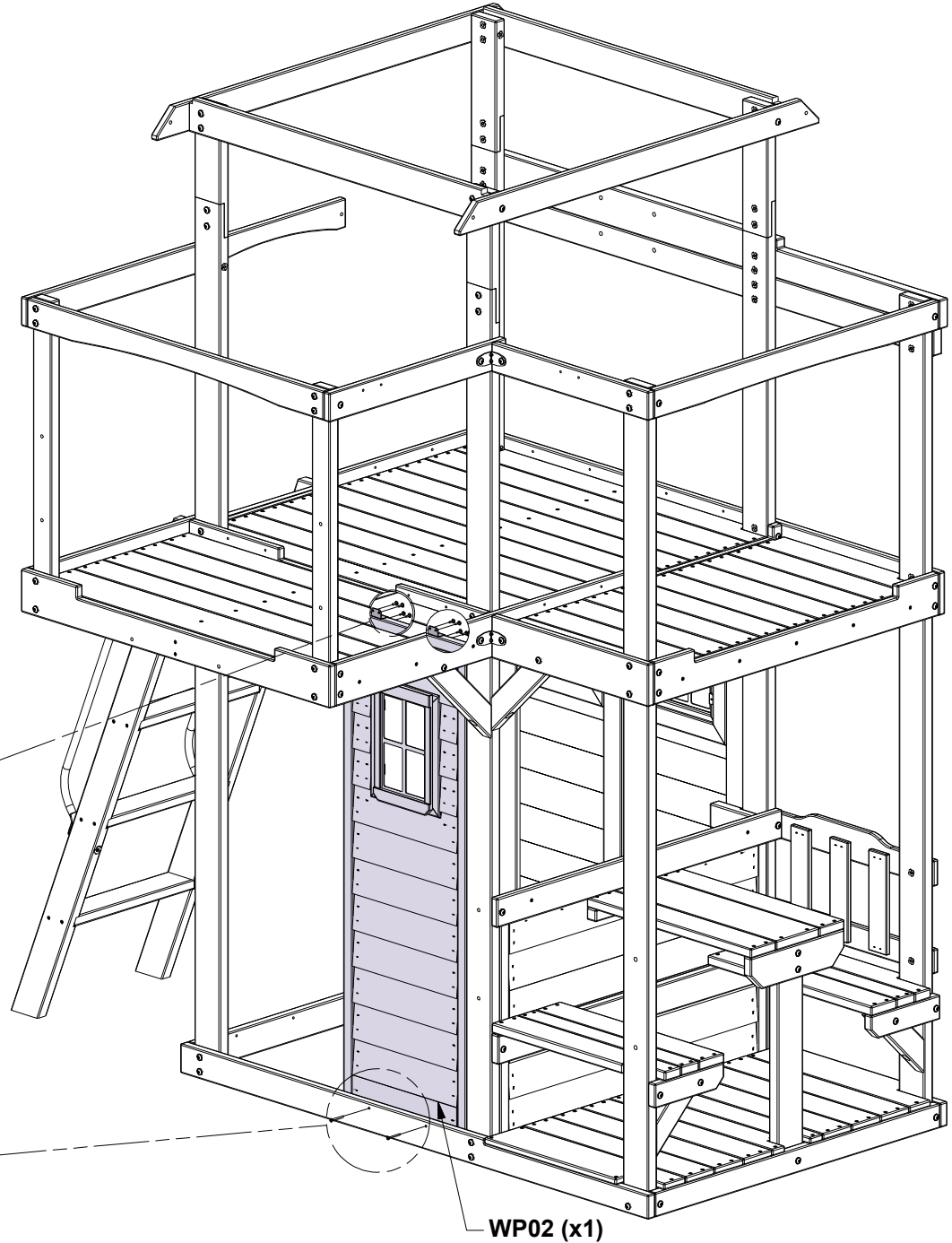
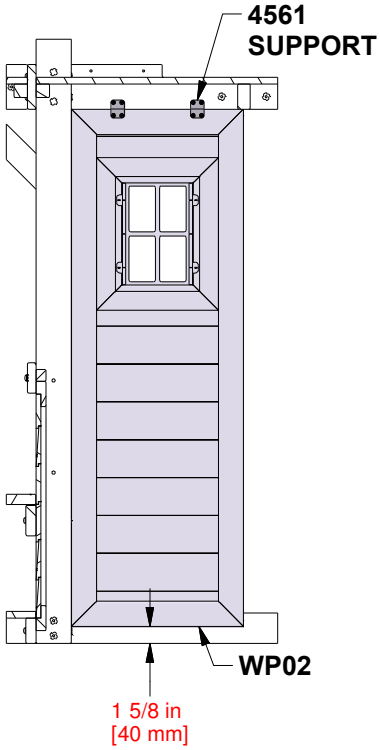

**202 (x8)**  
**VIS - 5/8"**

**4561 (x2)**  
**SUPPORT**

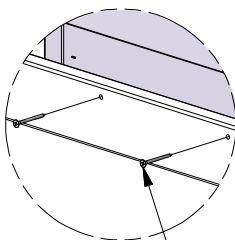
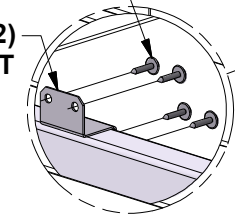

**382 (x2)**  
**VIS - 1 3/4"**

# ÉTAPE 32 - ASSEMBLAGE DE FORT

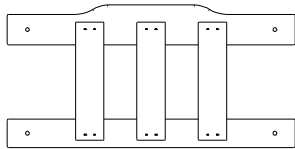

**WP07 DOSSIER DE BANC - W2A04240**  
(x1) 1 1/8"x11 7/8"x24 1/4" (28x301x610)



**OR09 BLOC DE SUPPORT - W4L21006**  
(x1) 1 1/8"x2 3/8"x5 3/4" (30x60x145)

QTÉ	N° DE PIÈCE	DESCRIPTION
1	H100391	VIS PFH 8x2 BLK
4	H100398	ÉCROU EN T 1/4 BLK
4	H100405	RONDELLE D'ARRET EXT 6x15 BLK
3	H101026	BOULON WH 1/4x1-3/4 BLK
1	H101376	BOULON WH 1/4x2 3/4 BLK

**INSTALLEZ LES ÉCROUS EN T DANS LE BOIS TOUT D'ABORD**

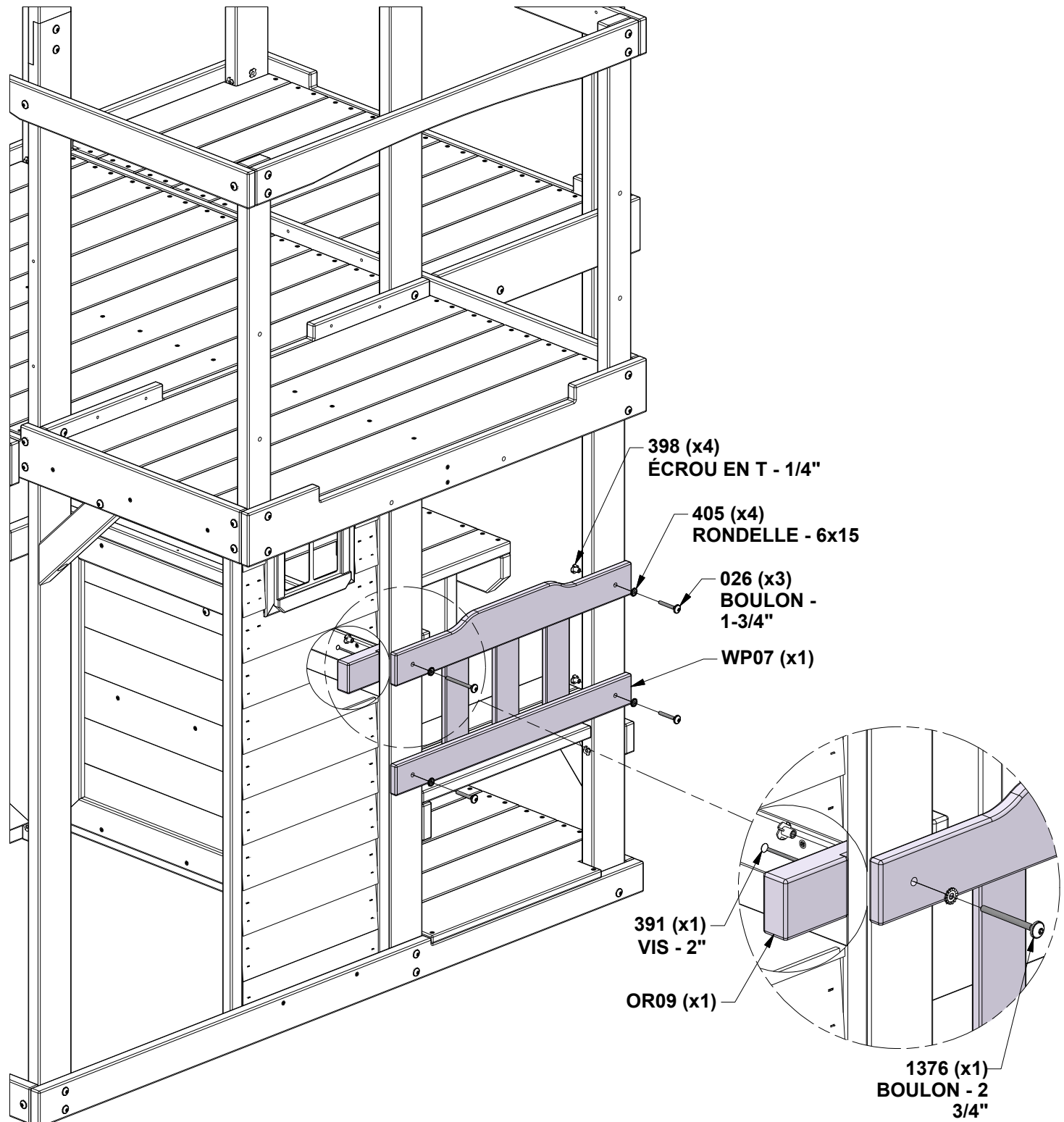

398 (x4)  
ÉCROU EN T - 1/4"

405 (x4)  
RONDELLE - 6x15

026 (x3)  
BOULON - 1-3/4"

WP07 (x1)

391 (x1)  
VIS - 2"

OR09 (x1)

1376 (x1)  
BOULON - 2 3/4"

# ÉTAPE 33 - ASSEMBLAGE DE FORT

QTÉ	N° DE PIECE	DESCRIPTION
10	H100086	VIS PFH 8x1-1/2



**MG06 PLAN DE TRAVAIL - W4L20997**  
(x1) 5/8"x3 1/4"x35 1/8" (16x84x891)



**MG07 PLAN DE TRAVAIL - W4L20998**  
(x1) 5/8"x3 1/4"x35 1/2" (16x84x903)

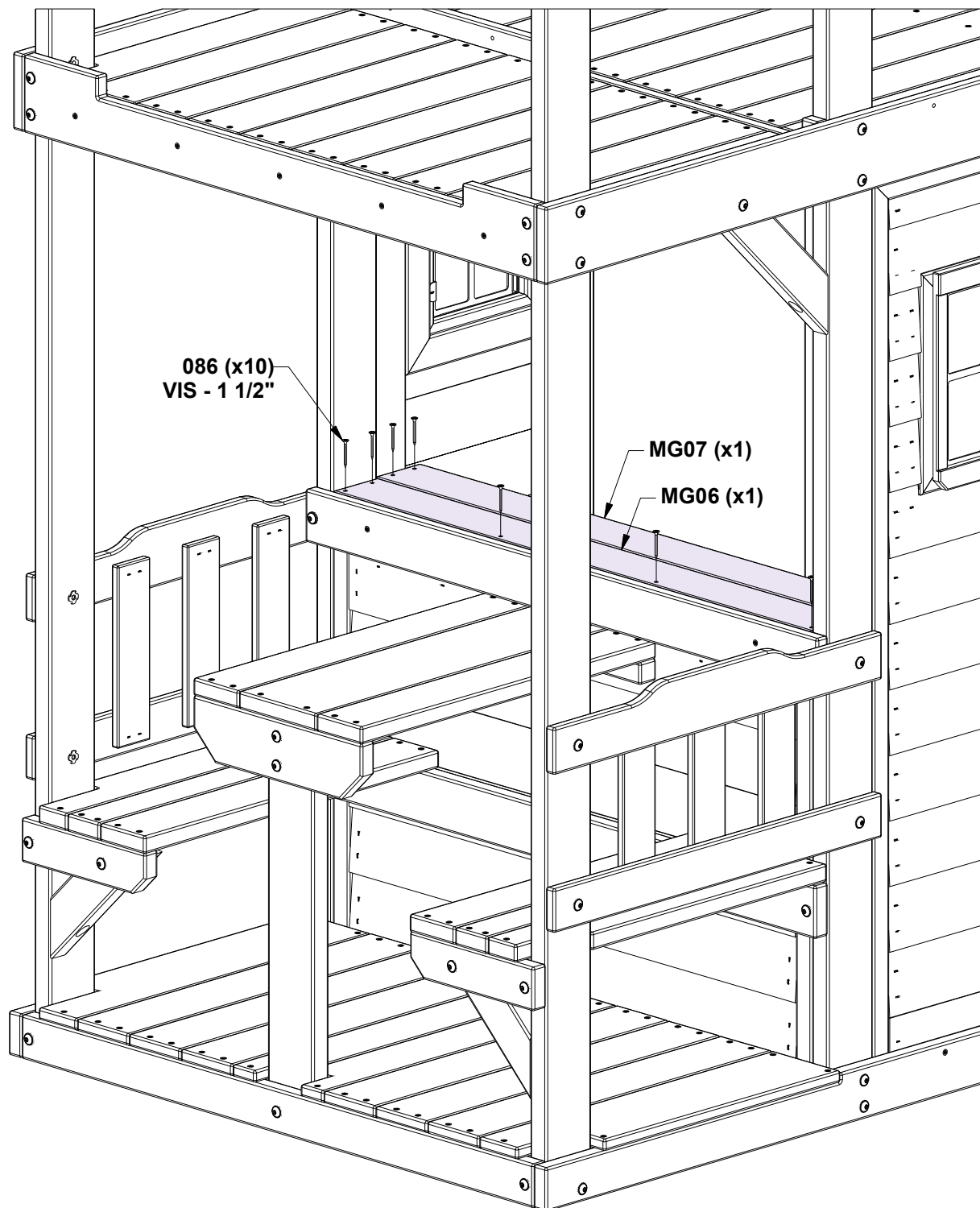

# ÉTAPE 34 - ASSEMBLAGE DE FORT

QTÉ	N° DE PIÈCE	DESCRIPTION
8	H100202	VIS PWH 8x5/8 BLK
2	H100382	VIS PFH 8x1 3/4 BLK

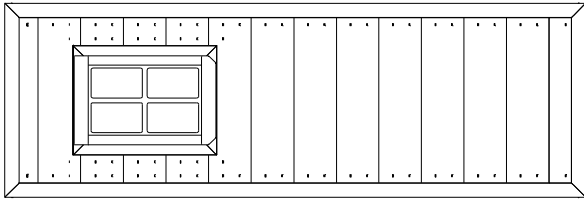

**WP02 PANNEAU MURAL - W2A04239**  
(x1) 1 5/8"x18 3/4"x40" (36x410x1230)

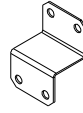

**A4M04561 SUPPORT**  
(x2)

## VUE INTÉRIEURE

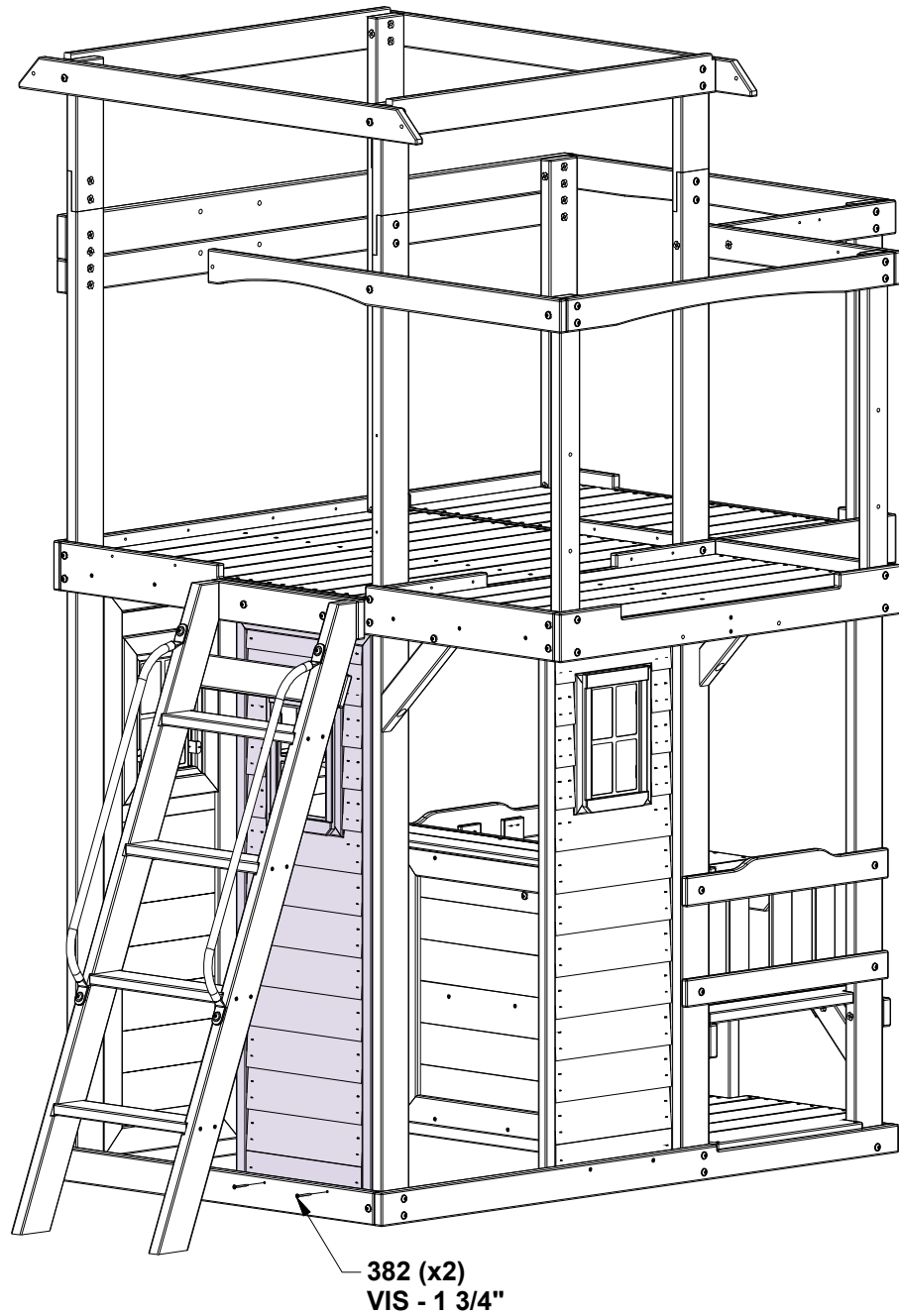
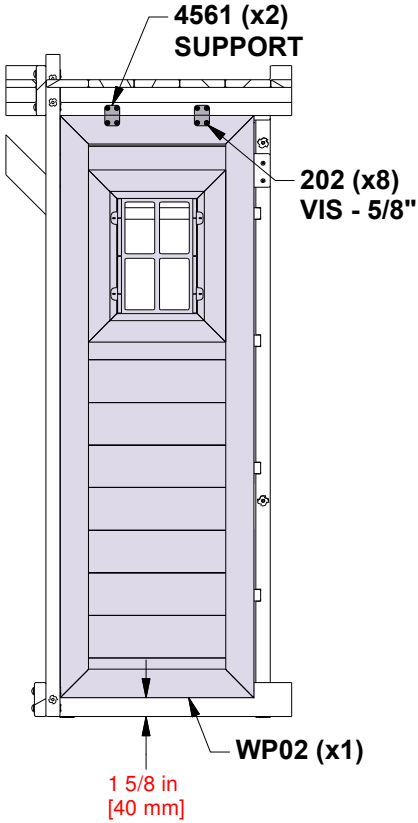

# ÉTAPE 35 - ASSEMBLAGE DE FORT

QTÉ	N° DE PIECE	DESCRIPTION
2	H100086	VIS PFH 8x1-1/2

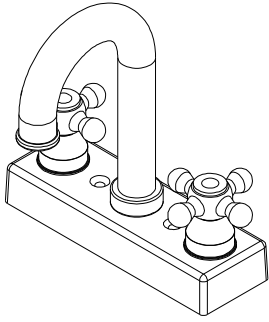

**A6P00024 MONTAGE DE ROBINET  
(x1)**

**PLACER COMME DÉSIRÉ**

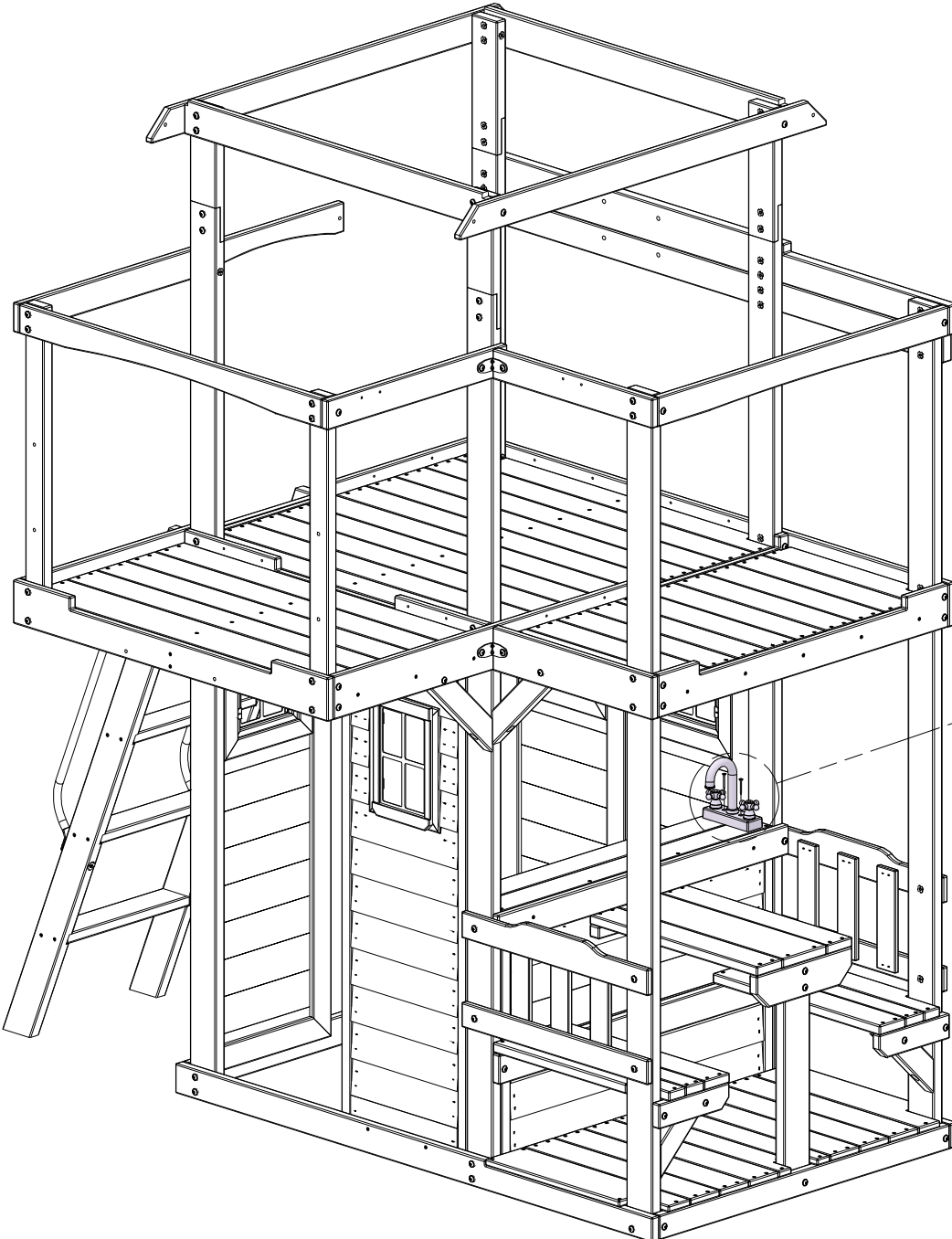

**086 (x2)  
VIS - 1 1/2"**

**024 (x1)  
MONTAGE DE  
ROBINET**

# ÉTAPE 36 - ASSEMBLAGE DE FORT

QTÉ	N° DE PIECE	DESCRIPTION
2	H100128	VIS PWH 8x5/8

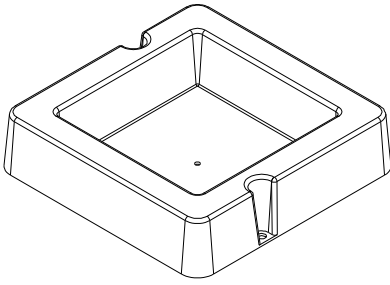

A6P00032 MONTAGE DE ÉVIER  
(x1)

**PLACER COMME DÉSIRÉ**

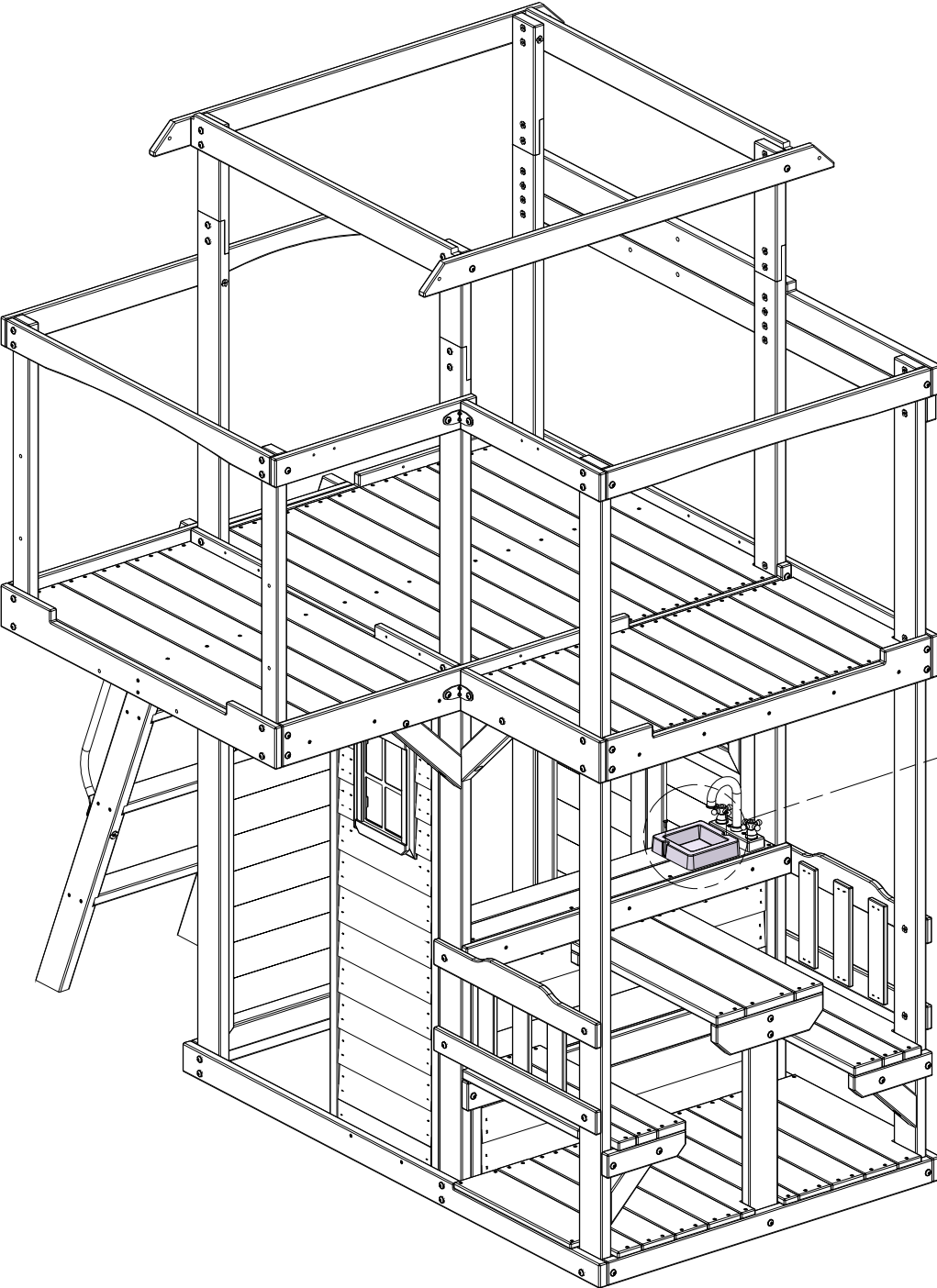

128 (x2)  
VIS - 5/8

032 (x1)  
MONTAGE DE ÉVIER

# ÉTAPE 37 - ASSEMBLAGE DE FORT

QTÉ	N° DE PIECE	DESCRIPTION
4	H100088	VIS PFH 8x1-1/8

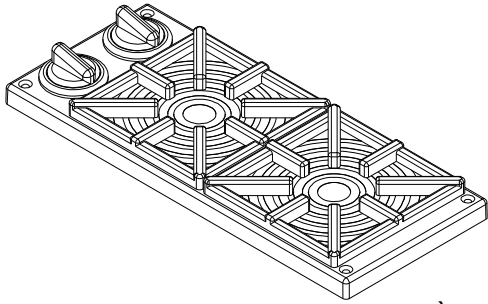

**A6P00025 MONTAGE DE CUISINIÈRE**  
(x1)

**PLACER COMME DÉSIRÉ**

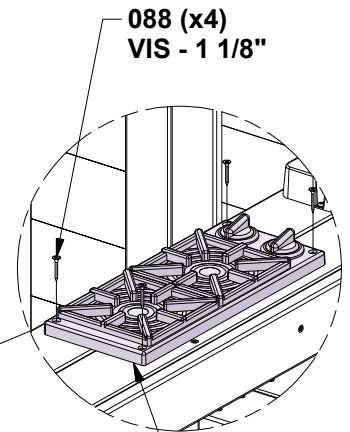
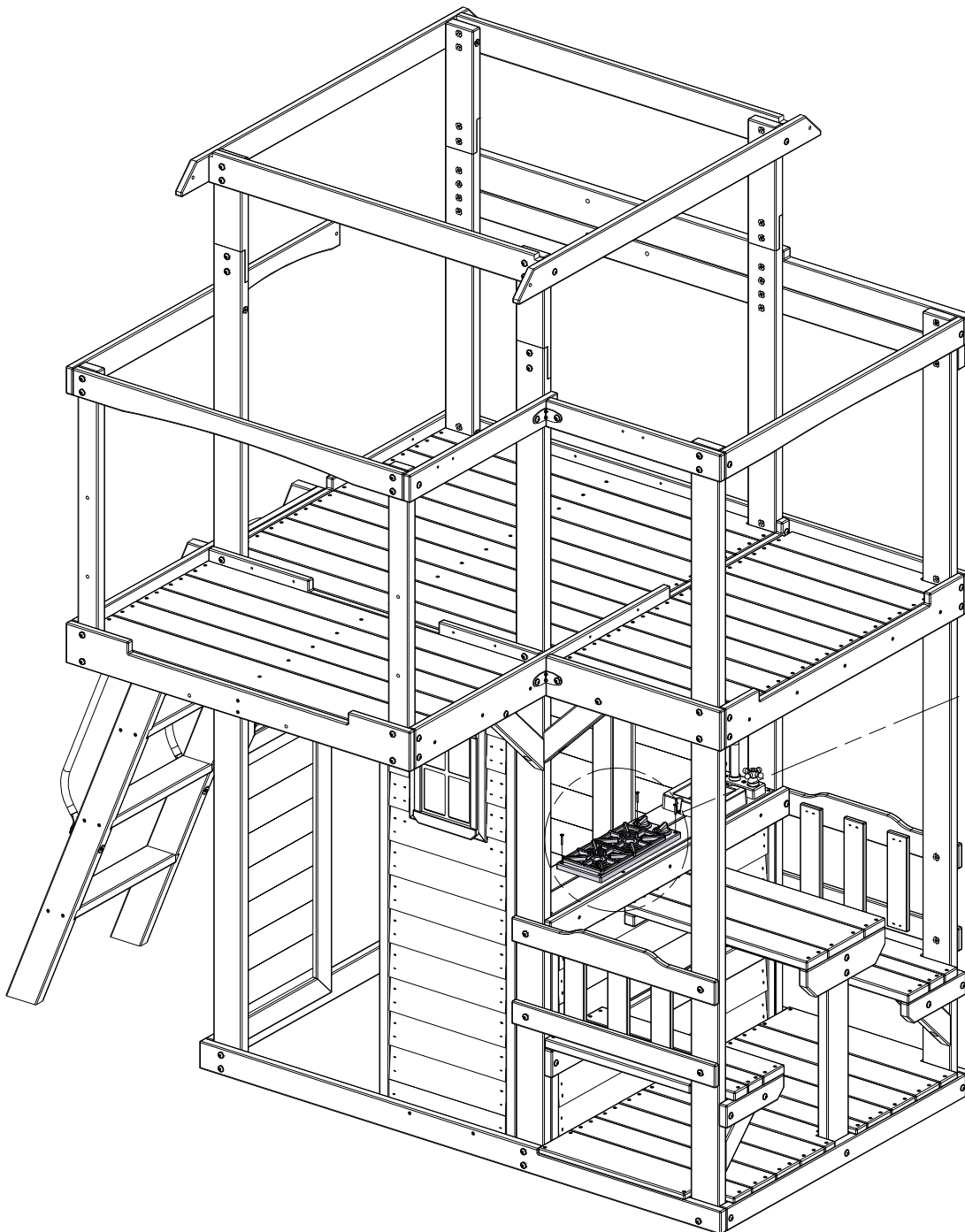

**088 (x4)  
VIS - 1 1/8"**

**025 (x1)  
MONTAGE DE  
CUISINIÈRE**

# ÉTAPE 38 - ASSEMBLAGE DE FORT

QTÉ	N° DE PIECE	DESCRIPTION
4	H100124	VIS PFH 8x1/2

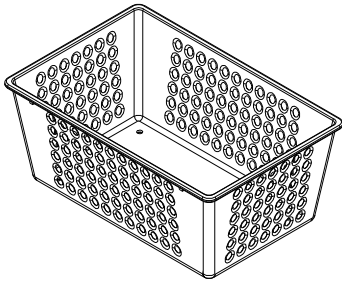

**A6P00069 KIT PANIER DE FRUITS  
(x1)**

**PLACER COMME DÉSIRÉ**

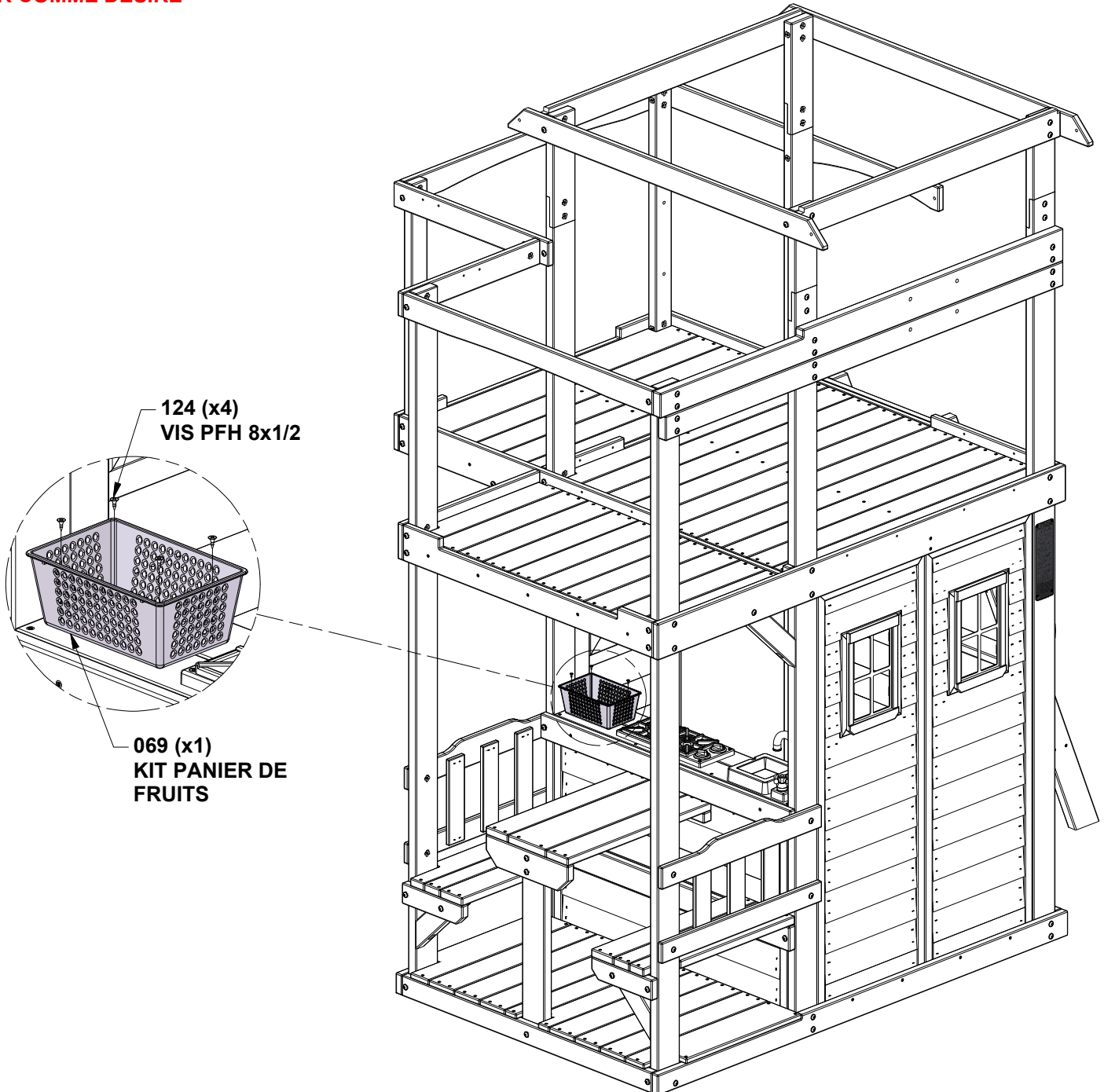

# ÉTAPE 39 - ASSEMBLAGE DE FORT

QTÉ	N° DE PIÈCE	DESCRIPTION
4	H100200	VIS PFH 8x1-1/2 BLK

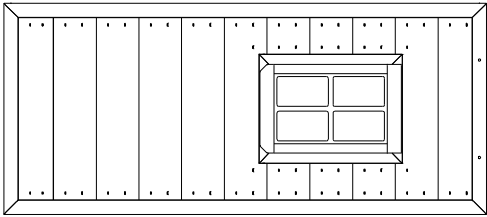

**WP08 PANNEAU MURAL - W2A04248**  
 (x1) 1 5/8"x18 3/4"x40" (36x446x1022)

## VUE INTÉRIEURE

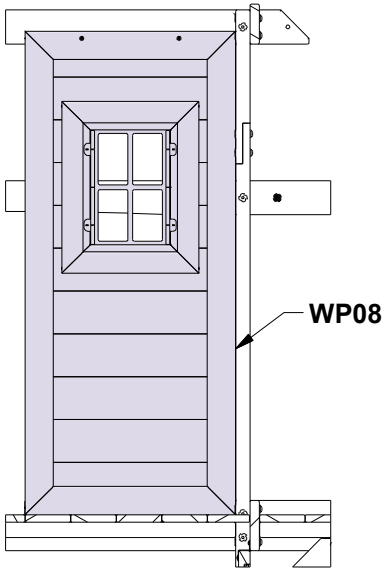

WP08 (x1)

200 (x2)  
VIS - 1 1/2"

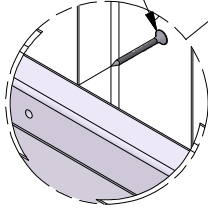

200 (x2)  
VIS - 1 1/2"

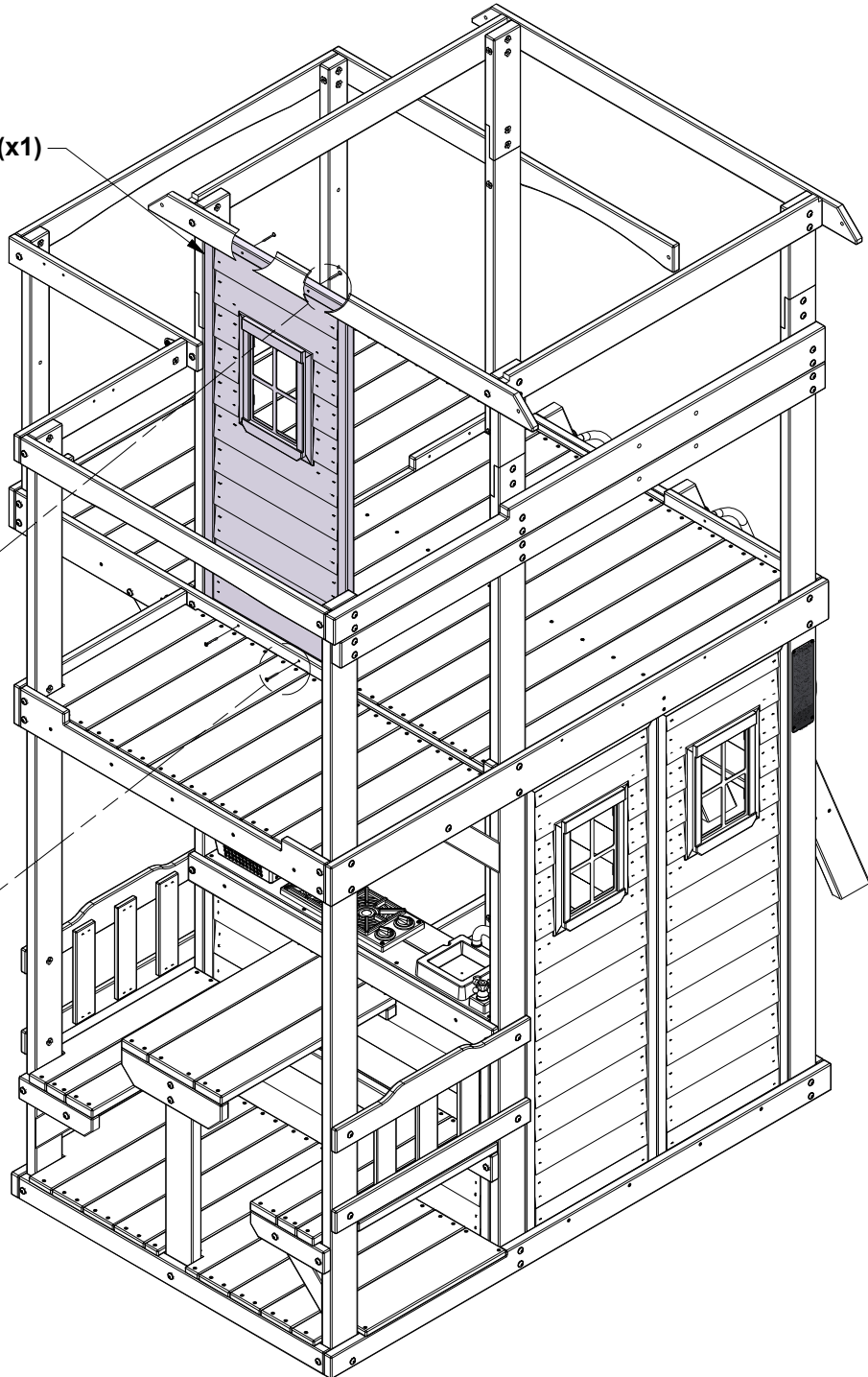
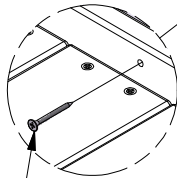

# ÉTAPE 40 - ASSEMBLAGE DE FORT

QTÉ	N° DE PIÈCE	DESCRIPTION
8	H100200	VIS PFH 8x1-1/2 BLK

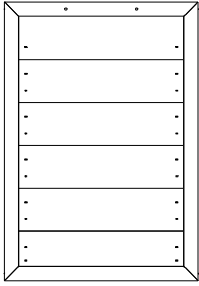

**WP04 PANNEAU MURAL - W2A04242**  
 (x2) 1"x16 1/8"x23 1/4" (24x410x589)

## VUE INTÉRIEURE

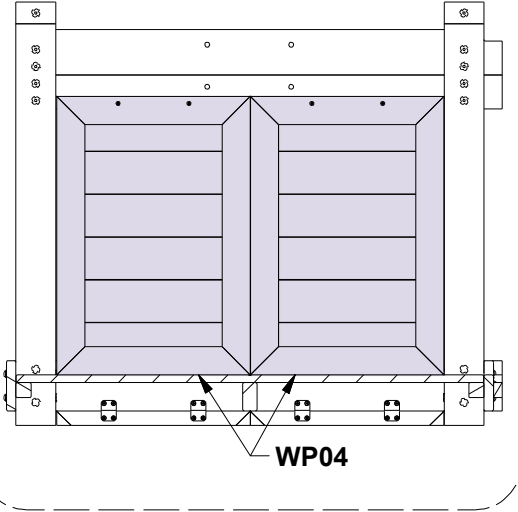

WP04 (x2)

200 (x4)  
VIS - 1 1/2"

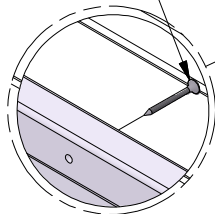

200 (x4)  
VIS - 1 1/2"

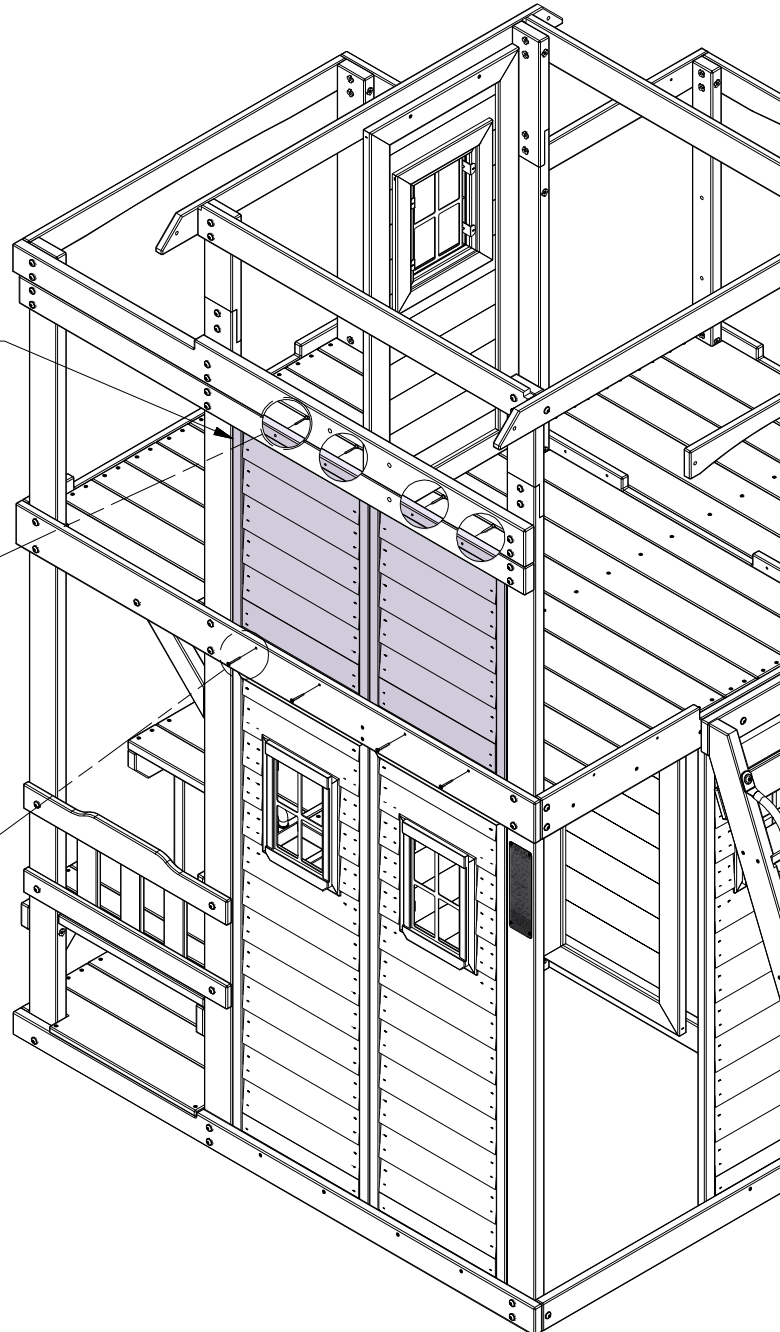
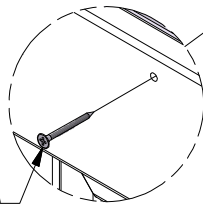

# ÉTAPE 41 - ASSEMBLAGE DE FORT

QTÉ	N° DE PIÈCE	DESCRIPTION
8	H100200	VIS PFH 8x1-1/2 BLK

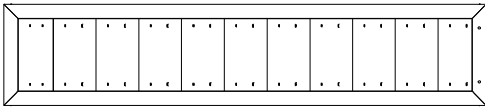

**WP05 PANNEAU MURAL - W2A04243**  
(x2) 1"x8 3/8"x39 1/8" (24x214x1022)

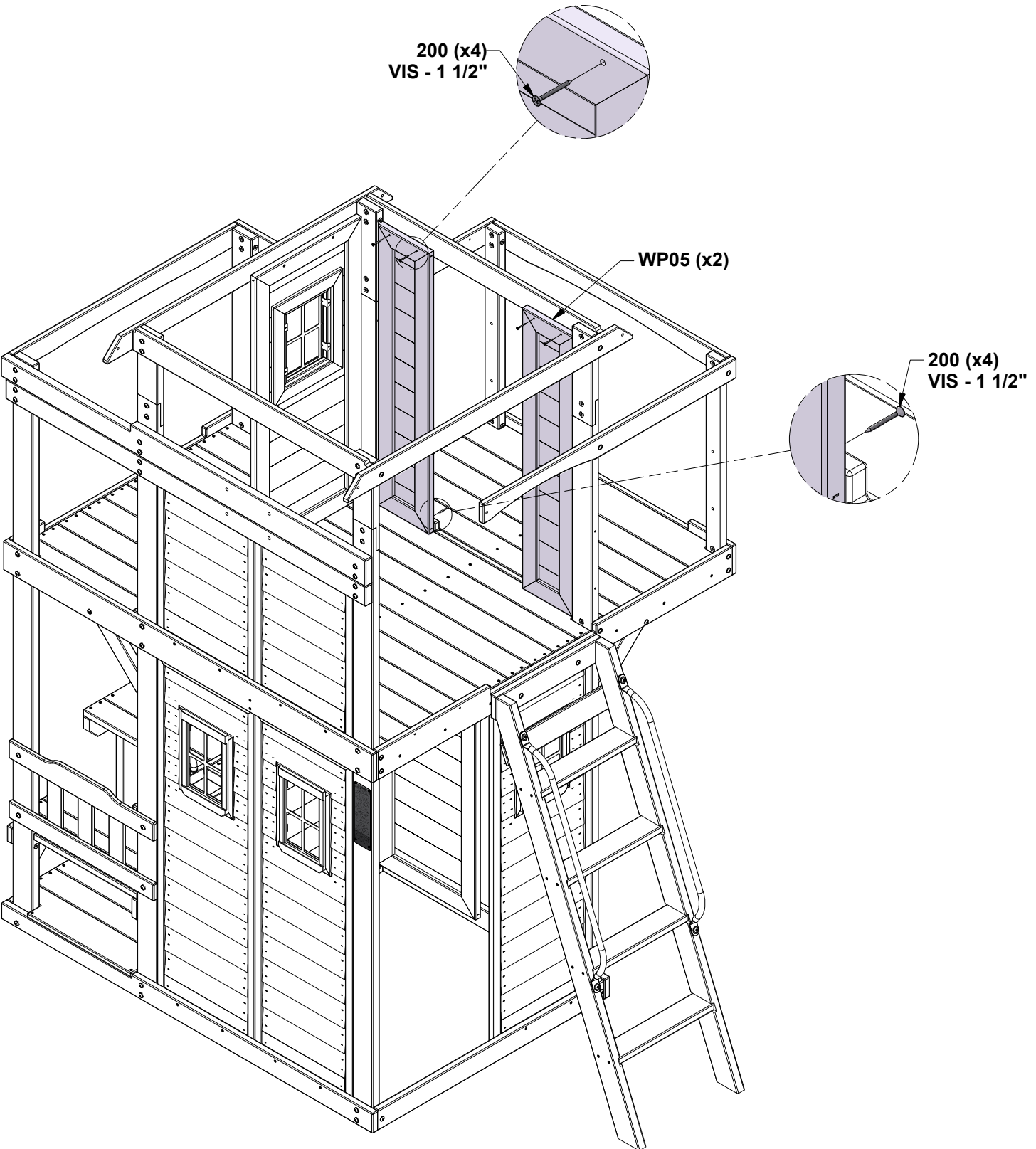

# ÉTAPE 42 - ASSEMBLAGE DE FORT

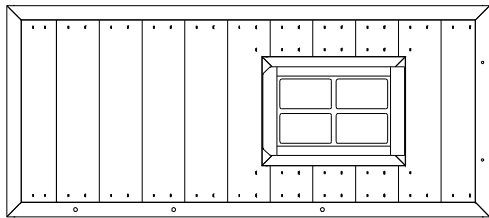

**WP03 PANNEAU MURAL - W2A04241**  
(x1) 1 3/8"x17 1/2"x40 1/4" (36x446x1022)

**HAUT**

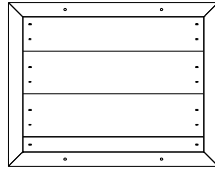

**WP06 PANNEAU MURAL - W2A04244**  
(x1) 1"x11 3/8"x17 1/2" (24x346x444)

QTÉ	N° DE PIÉCE	DESCRIPTION
8	H100200	VIS PFH 8x1-1/2 BLK
1	H100398	ÉCROU EN T 1/4 BLK
1	H100405	RONDELLE D'ARRET EXT 6x15 BLK
1	H101026	BOULON WH 1/4x1-3/4 BLK

**INSTALLER D'ABORD L'ÉCROU EN T DANS LE BOIS**

**ALIGNEZ**

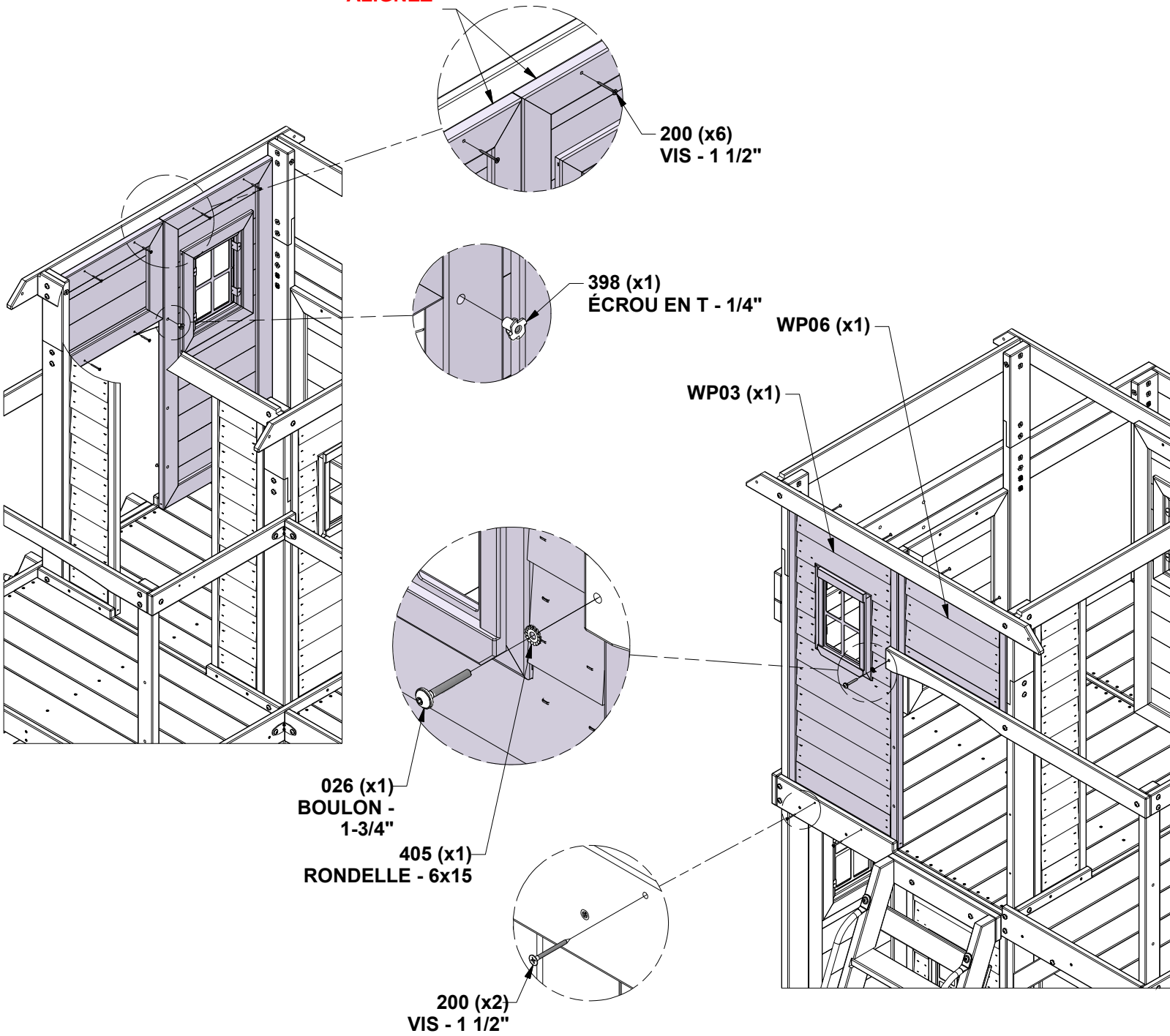

# ÉTAPE 43 - ASSEMBLAGE DE FORT

QTÉ	N° DE PIÈCE	DESCRIPTION
32	H100088	VIS PFH 8x1-1/8



**MR02 PIQUET - W4L21004**  
(x8) 5/8"x2 3/8"x26" (16x60x660)

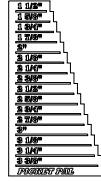

**A6P00410 PIQUET PAL**  
(x1)

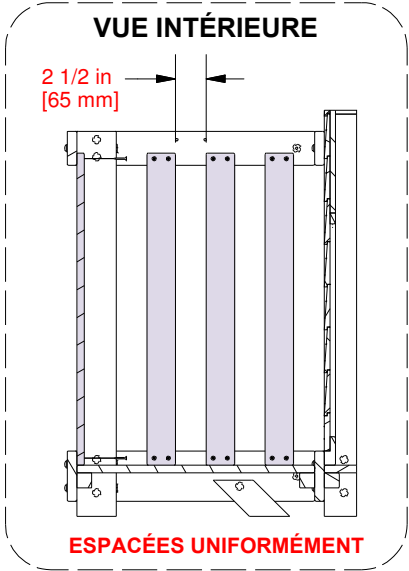

**UTILISEZ LE AIDE-PIQUET  
A6P00410 POUR  
L'ESPACEMENT**

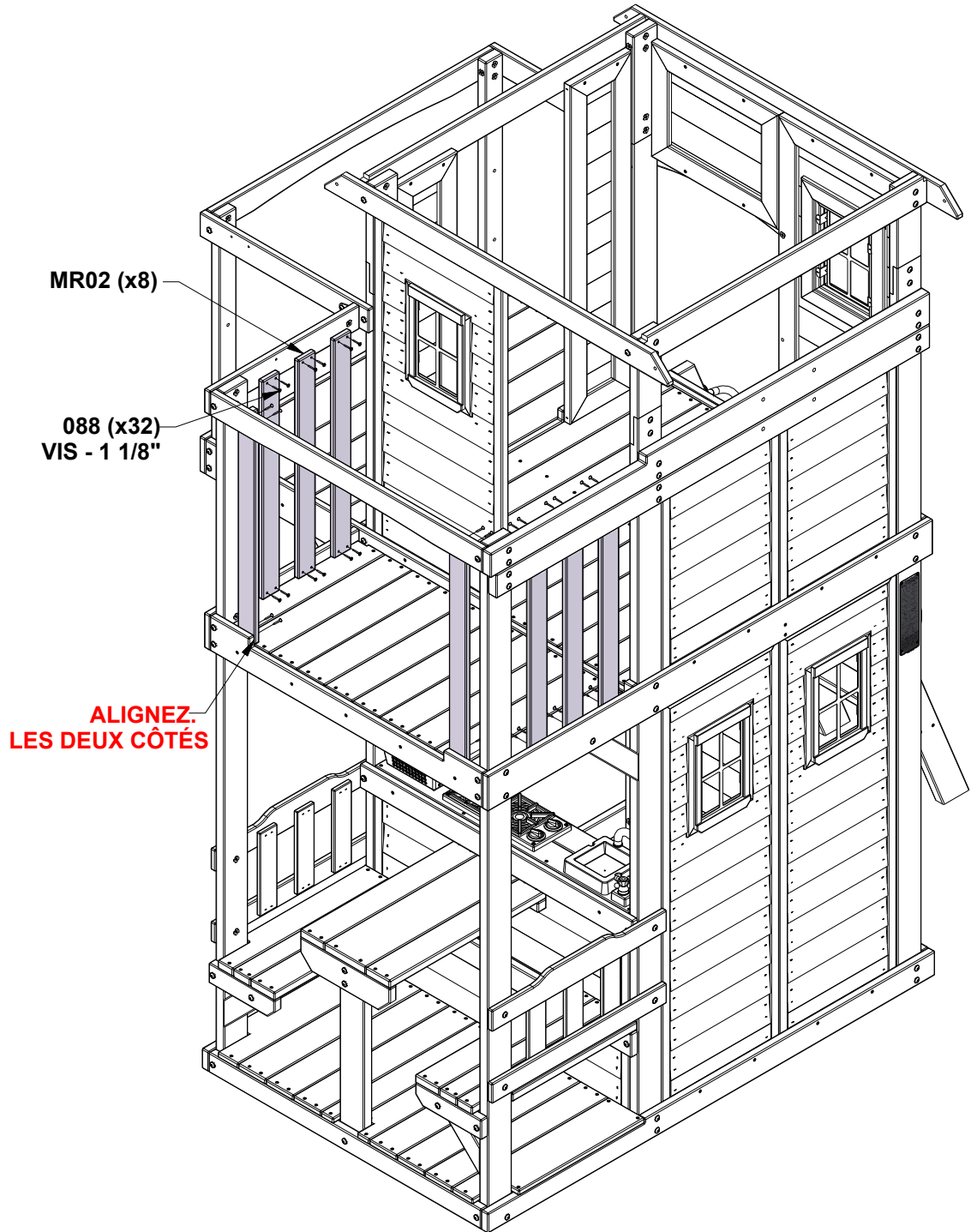

# ÉTAPE 44 - ASSEMBLAGE DE FORT

QTÉ	N° DE PIÈCE	DESCRIPTION
40	H100088	VIS PFH 8x1-1/8

MR02 PIQUET - W4L21004  
(x10) 5/8"x2 3/8"x26" (16x60x660)

## VUE INTÉRIEURE

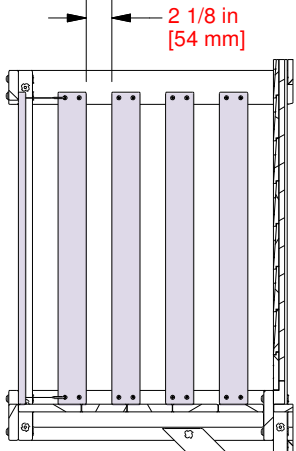

ESPACÉES UNIFORMÉMENT

MR02 (x10)

088 (x40)  
VIS - 1 1/8"

ALIGNER  
LES DEUX  
CÔTÉS

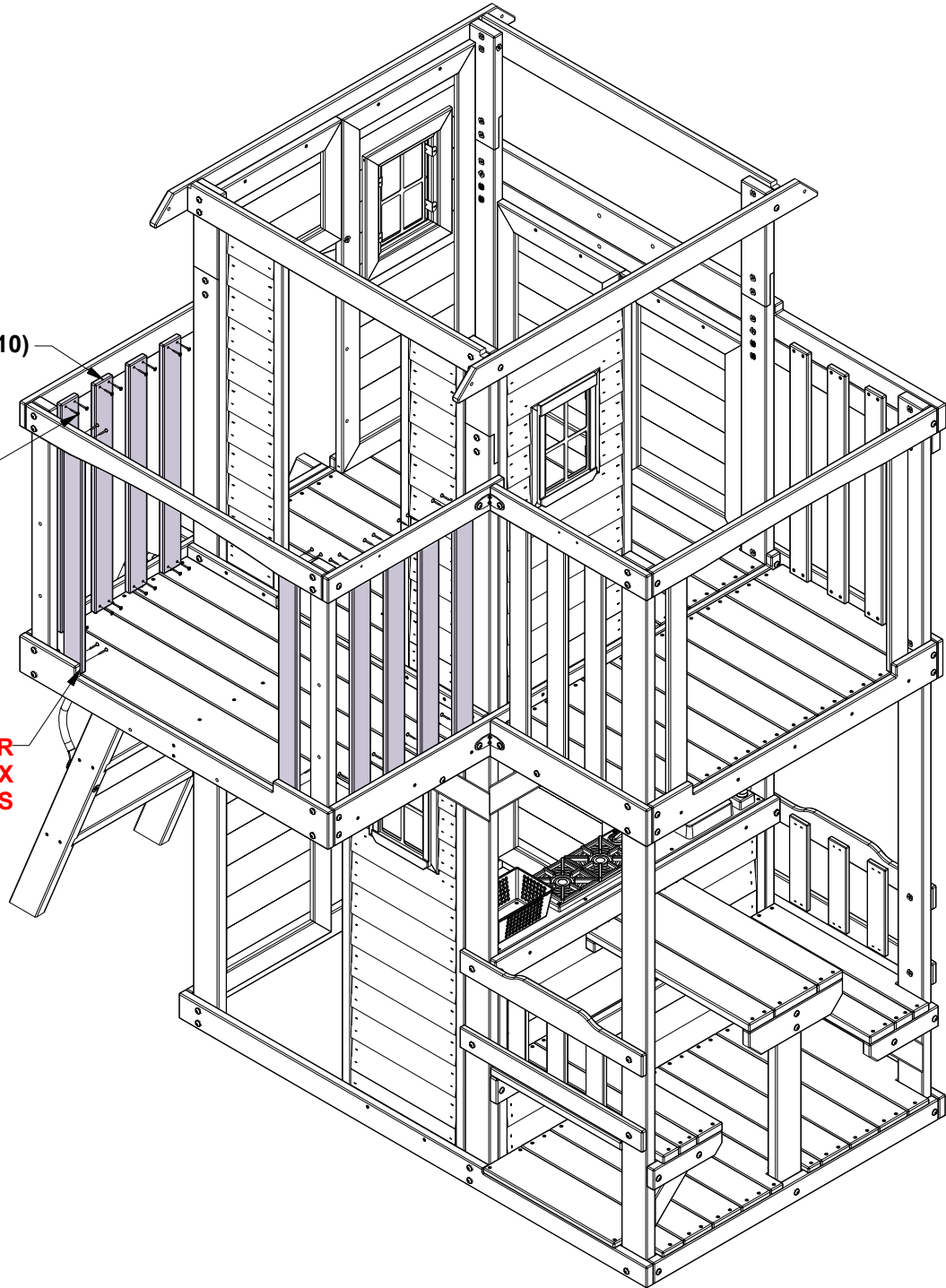

# ÉTAPE 45 - ASSEMBLAGE DE FORT

QTÉ	N° DE PIÈCE	DESCRIPTION
4	H100128	VIS PWH 8x5/8
2	H100397	BOULON WH 1/4x1-1/4 BLK
2	H100398	ÉCROU EN T 1/4 BLK
2	H100405	RONDELLE D'ARRET EXT 6x15 BLK

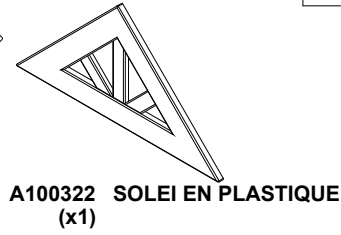
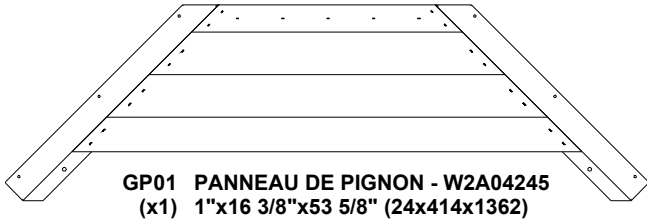

**INSTALLEZ LES ÉCROUS EN T DANS LE BOIS TOUT D'ABORD**

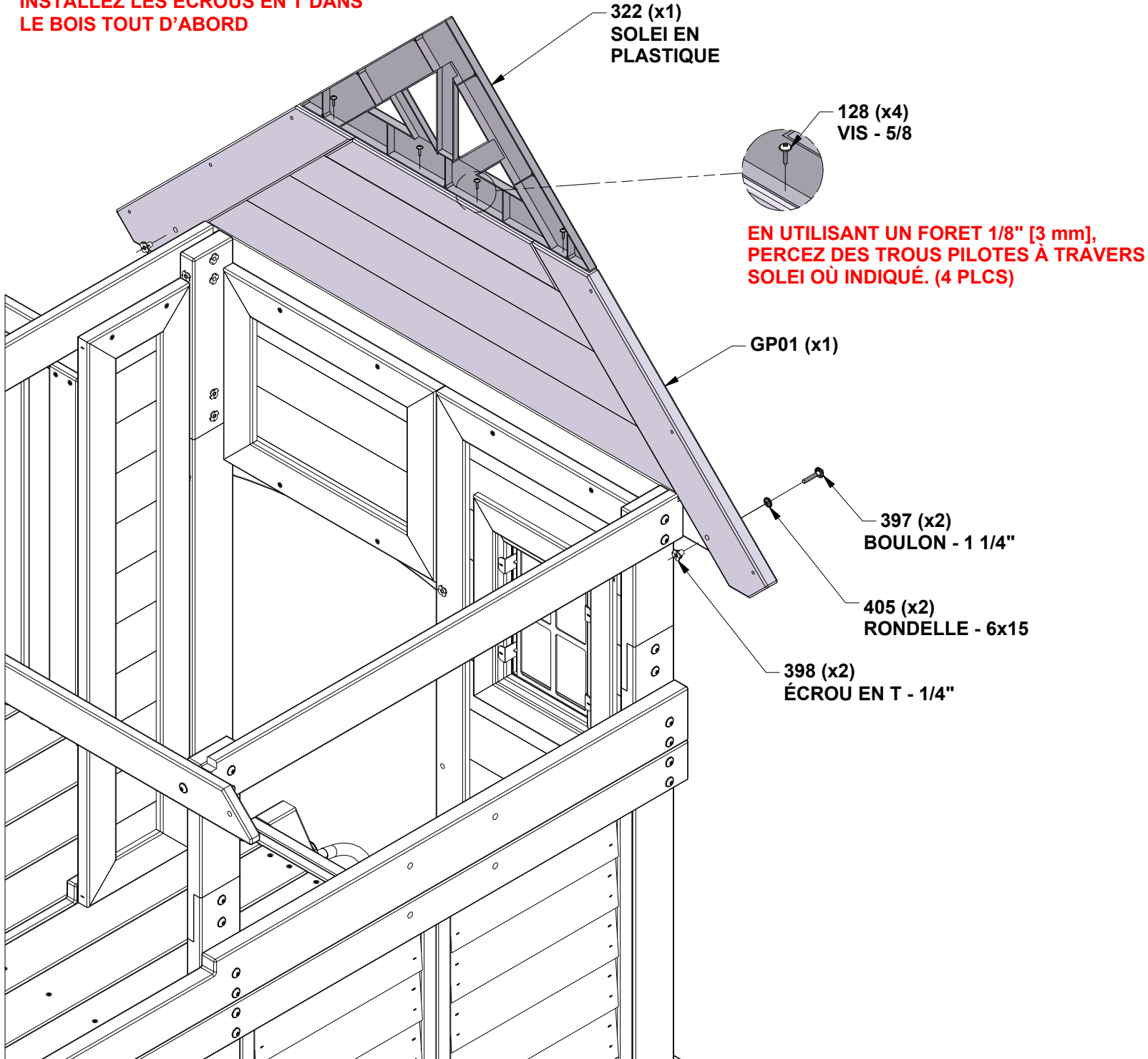

# ÉTAPE 46 - ASSEMBLAGE DE FORT

QTÉ	N° DE PIÈCE	DESCRIPTION
4	H100128	VIS PWH 8x5/8
2	H100397	BOULON WH 1/4x1-1/4 BLK
2	H100398	ÉCROU EN T 1/4 BLK
2	H100405	RONDELLE D'ARRET EXT 6x15 BLK

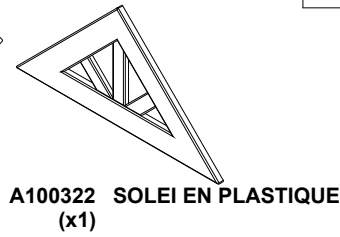
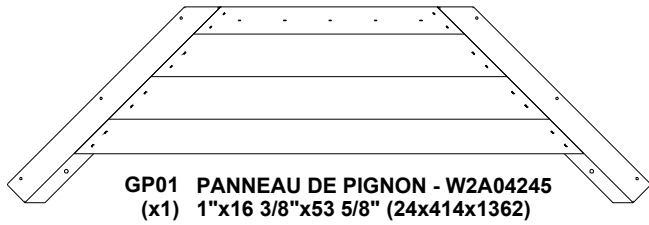

**INSTALLEZ LES ÉCROUS EN T DANS LE BOIS TOUT D'ABORD**

128 (x4)  
VIS - 5/8

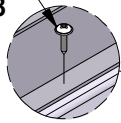

**EN UTILISANT UN FORET 1/8" [3 mm],  
PERCEZ DES TROUS PILOTES À TRAVERS  
SOLEI OÙ INDIQUÉ. (4 PLCS)**

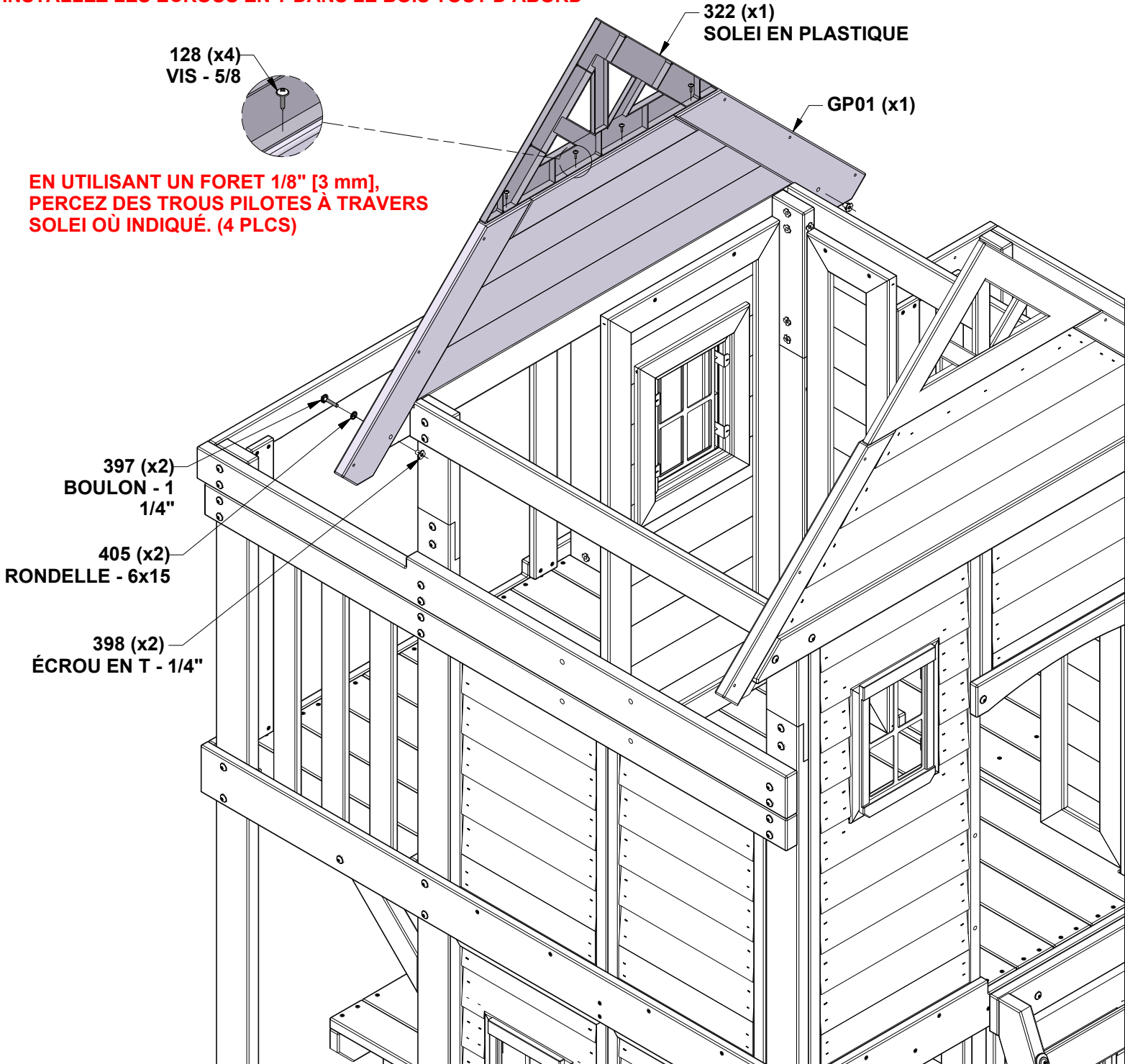

# ÉTAPE 47 - ASSEMBLAGE DE FORT

QTÉ	N° DE PIÈCE	DESCRIPTION
8	H100128	VIS PWH 8x5/8

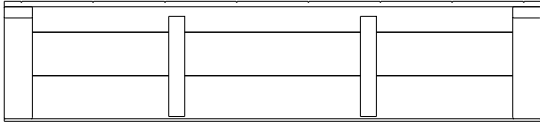

RP02 PANNEAU DE TOIT - W2A04247  
(x2) 1 3/8"x10"x44 3/4" (35x253x1137)

VUE DE CÔTÉ

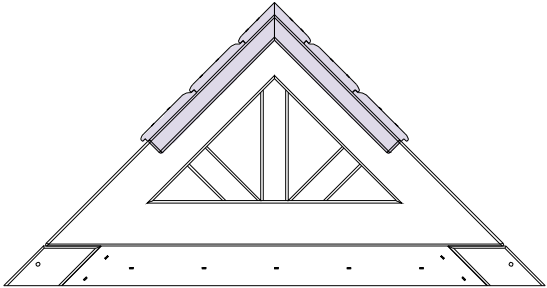

**CORRIGER LE PLACEMENT DU PANNEAU**

**EN UTILISANT UN FORET 1/8" [3 mm], PERCEZ DES TROUS PILOTES À TRAVERS SOLEI OÙ INDIQUÉ. (8 PLCS)**

128 (x8)  
VIS - 5/8

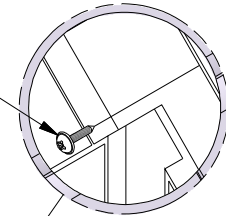

RP02 (x2)

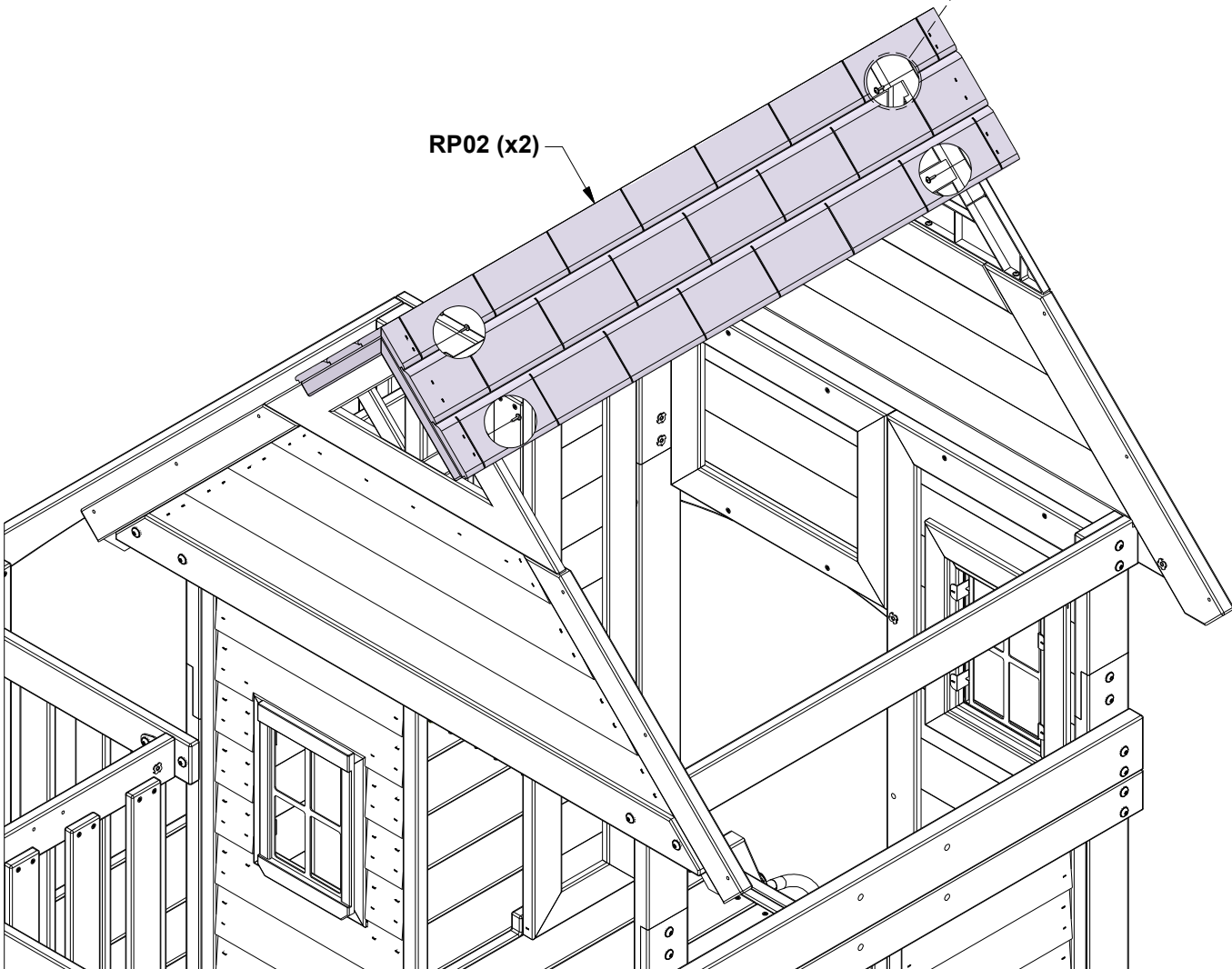

# ÉTAPE 48 - ASSEMBLAGE DE FORT

QTÉ	N° DE PIÈCE	DESCRIPTION
12	H100089	VIS PFH 8x1-3/4
4	H100128	VIS PWH 8x5/8

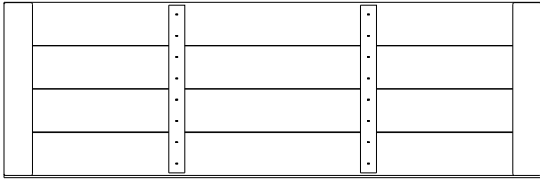

**RP01 PANNEAU DE TOIT - W2A04246**  
 (x4) 1 3/8" x 19 3/8" x 46 3/4" (35x370x1137)

**EN UTILISANT UN FORET 1/8" [3 mm], PERCEZ DES TROUS PILOTES À TRAVERS LES SOLEI OÙ INDIQUÉ. (4 PLCS)**

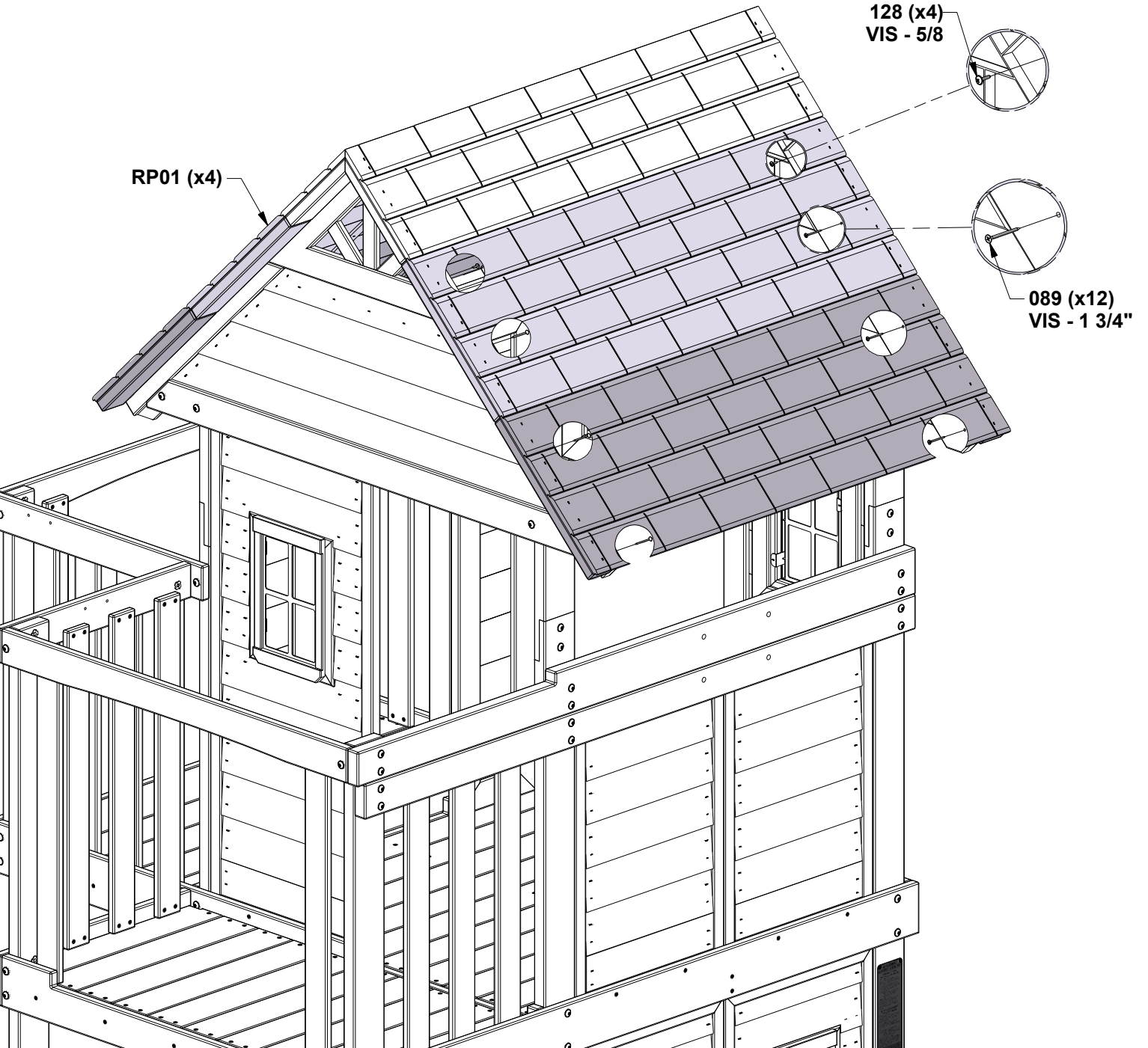

# ÉTAPE 49 - ASSEMBLAGE DE FORT

QTÉ	N° DE PIÈCE	DESCRIPTION
2	H100382	VIS PFH 8x1 3/4 BLK

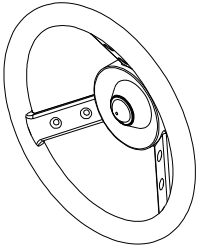

A100107 VOLANT  
(x1)



EB10 BLOC DE MONTAGE - W4L21007  
(x1) 1 3/8"x3"x4 3/4" (36x76x120)

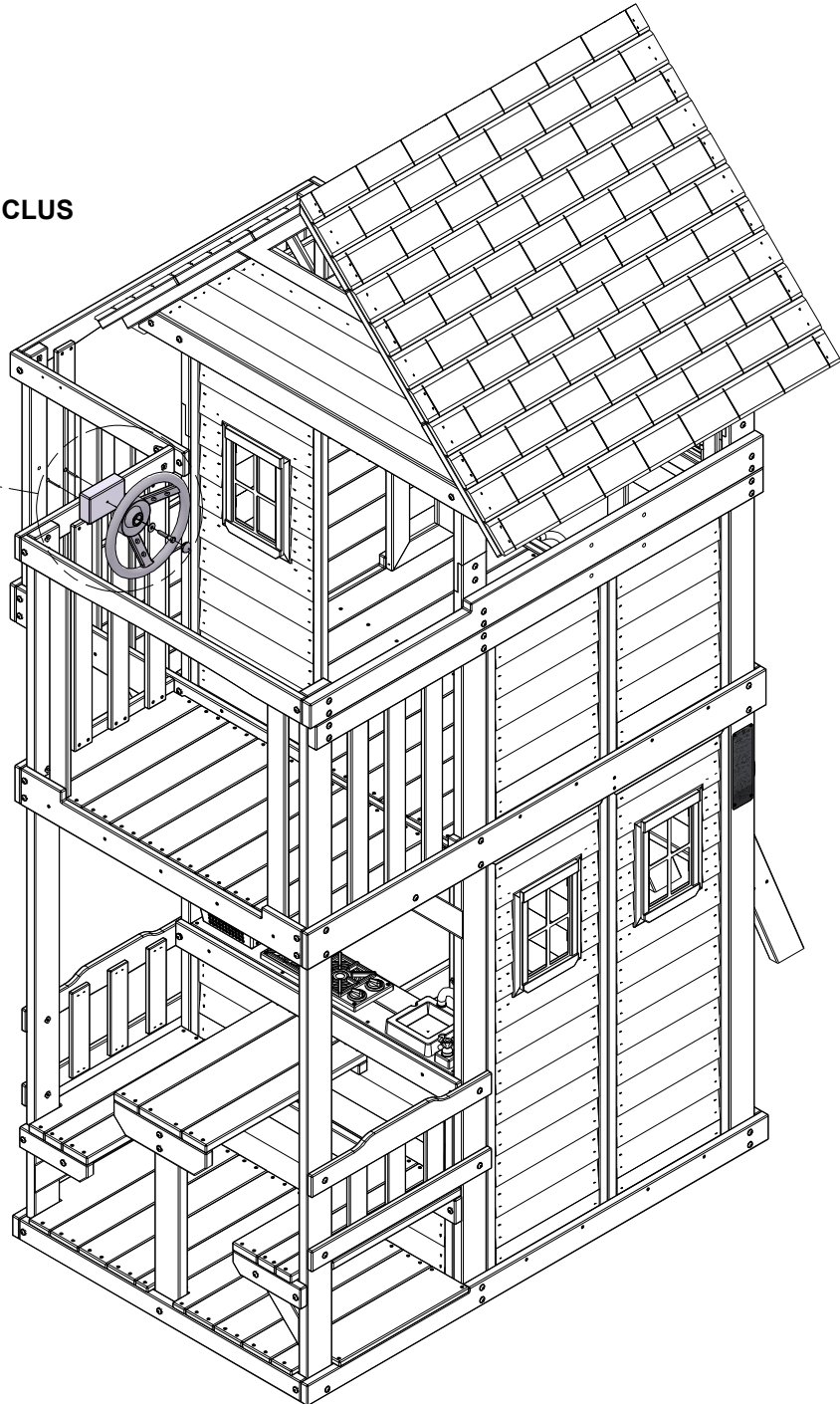
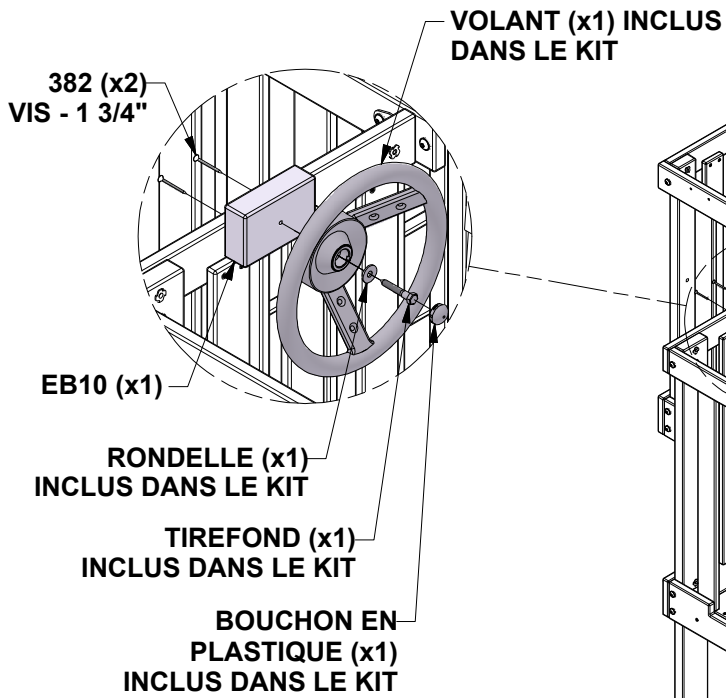

# ÉTAPE 50 - ASSEMBLAGE DE FORT

QTÉ	N° DE PIECE	DESCRIPTION
2	H100382	VIS PFH 8x1 3/4 BLK
2	H100087	VIS PFH 8x1-1/4

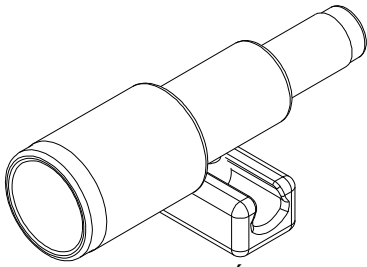

**A6P00096 TÉLESCOPE**  
(x1)



**EB10 BLOC DE MONTAGE - W4L21007**  
(x1) 1 3/8"x3"x4 3/4" (36x76x120)

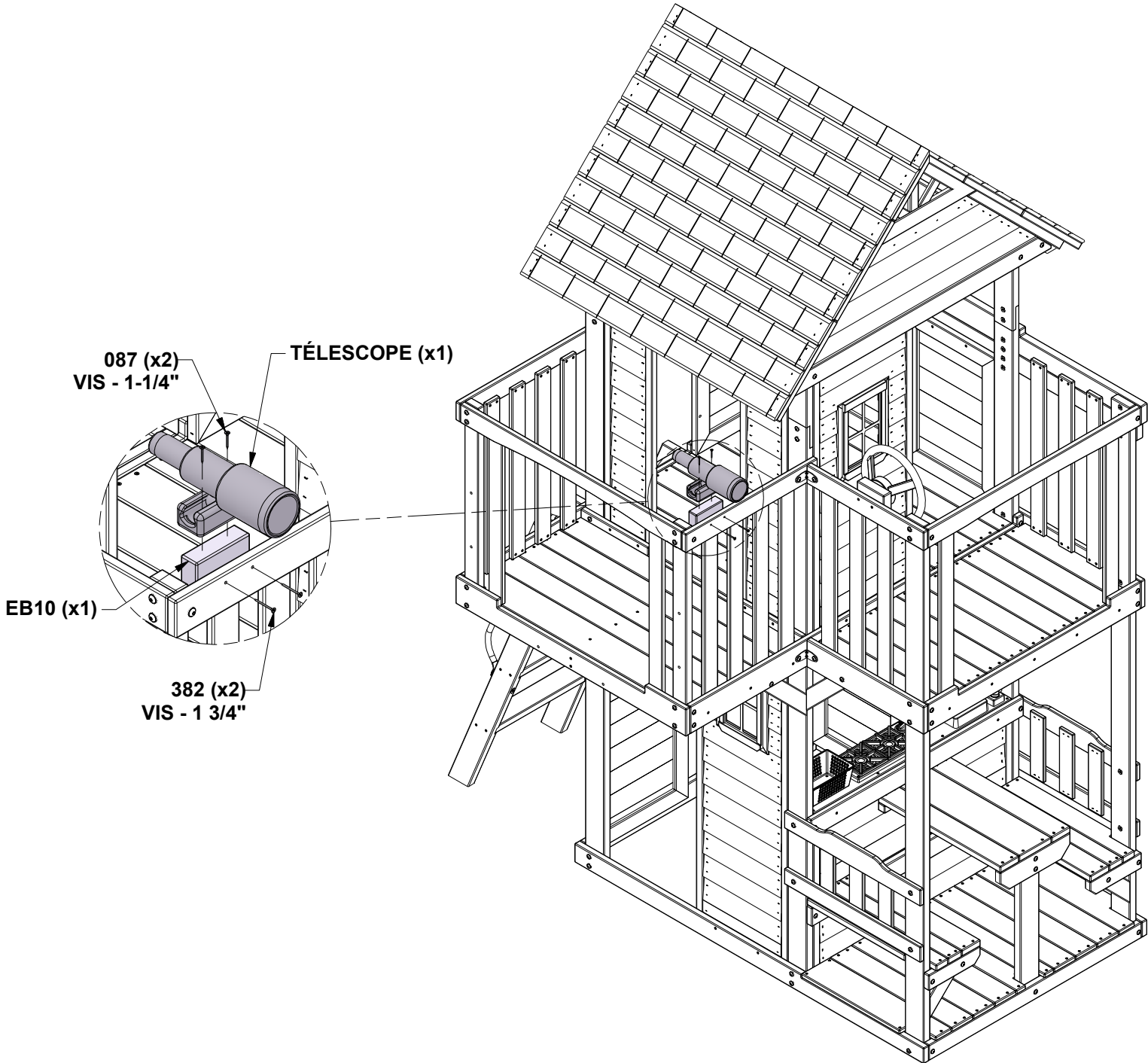

# ÉTAPE 51 - ASSEMBLAGE DE FORT

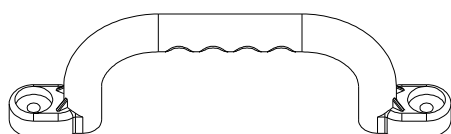

A6P00303 POIGNÉE  
(x2) JAUNE

QTÉ	N° DE PIÈCE	DESCRIPTION
2	H100072	ÉCROU EN T 1/4"
4	H100138	RONDELLE D'ARRET EXT 6x15
2	H100142	BOULON WH 1/4x1-1/4"
2	H100145	TIREFOND WH 1/4x1-1/2"

**INSTALLEZ LES ÉCROUS EN T DANS LE BOIS TOUT D'ABORD**

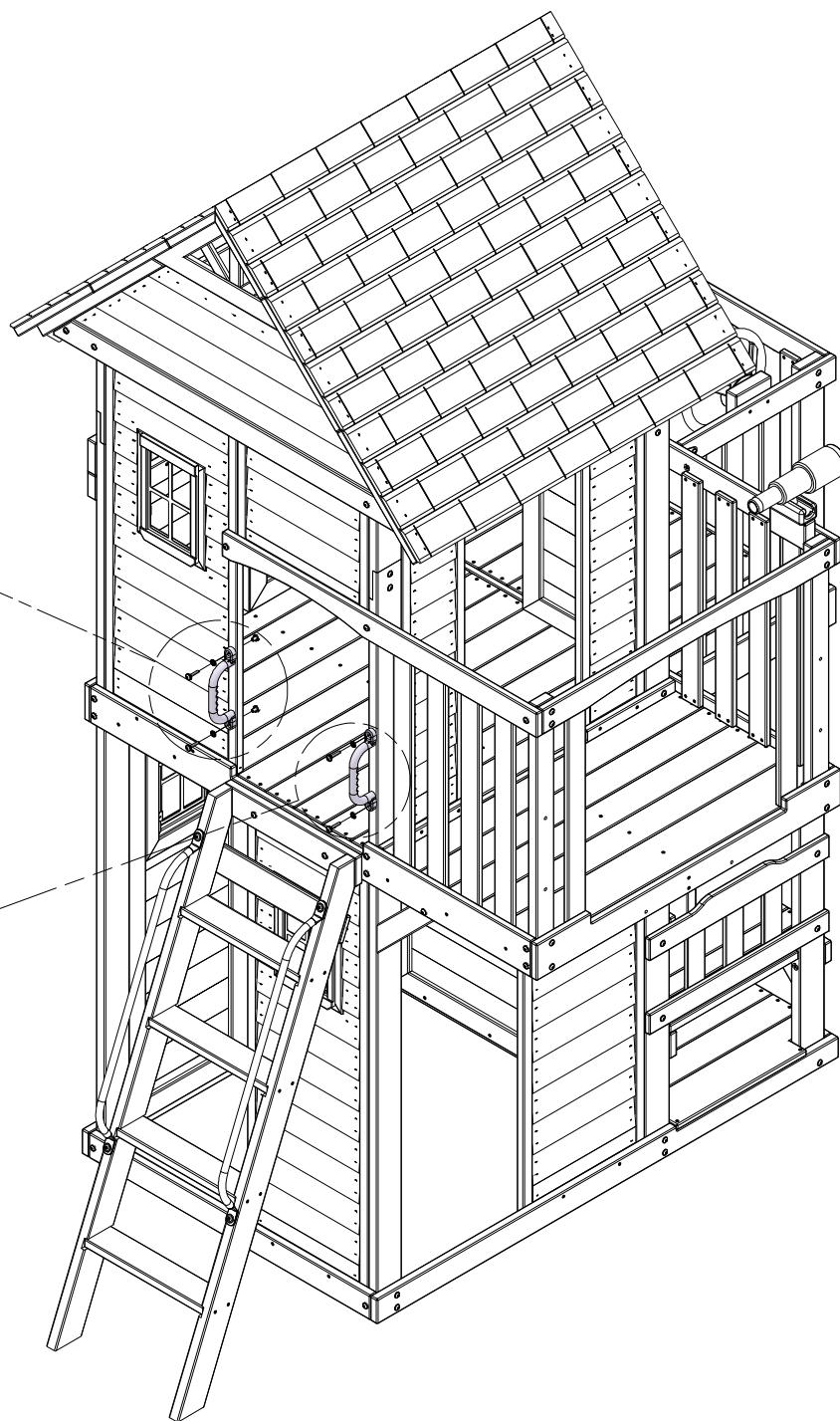
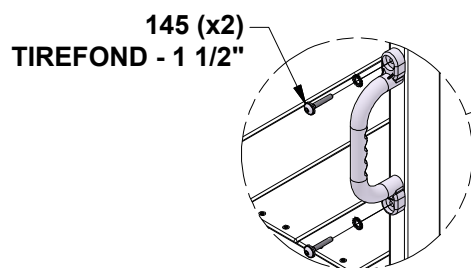
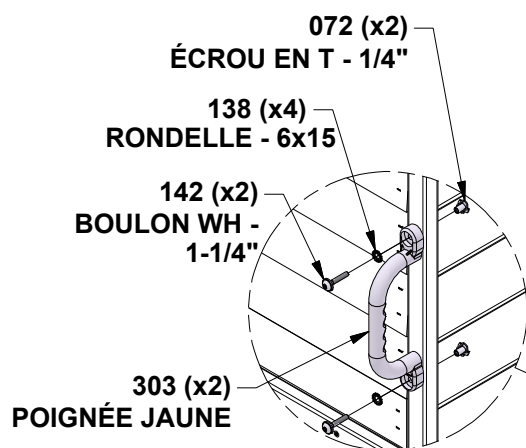

# ÉTAPE 52 - ASSEMBLAGE DE FORT

QTÉ	N° DE PIÈCE	DESCRIPTION
4	H100072	ÉCROU EN T 1/4"
4	H100138	RONDELLE D'ARRÊT EXT 6x15
4	H100143	BOULON WH 1/4x1-1/2"

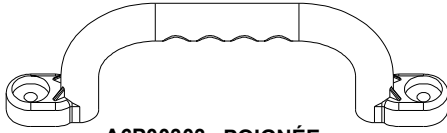

**A6P00303 POIGNÉE  
(x2) JAUNE**

**INSTALLEZ LES ÉCROUS EN T DANS LE BOIS TOUT D'ABORD**

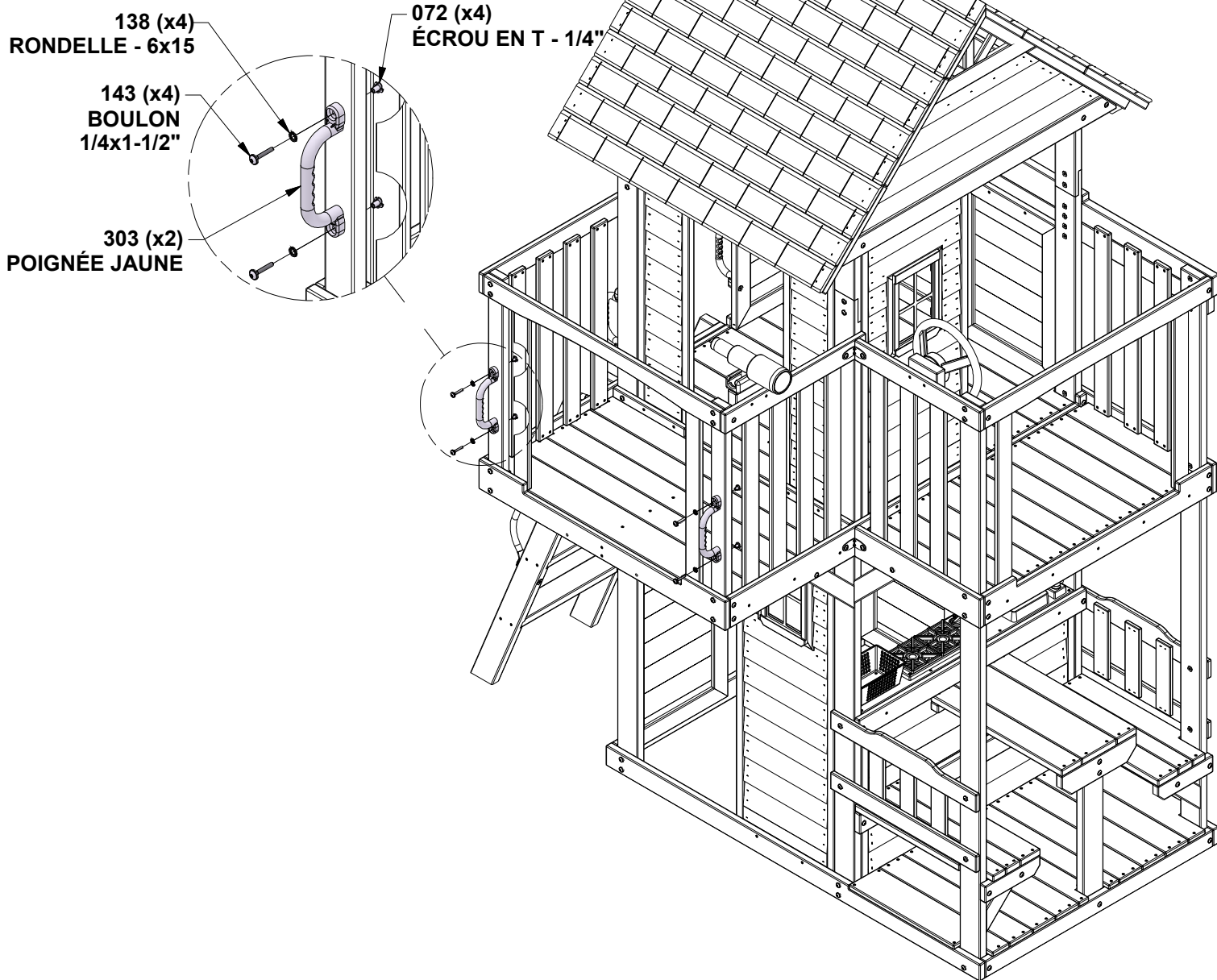

# ÉTAPE 53 - ASSEMBLAGE DE FORT

QTÉ	N° DE PIÈCE	DESCRIPTION
2	H100405	RONDELLE D'ARRET EXT 6x15 BLK
2	H101026	BOULON WH 1/4x1-3/4 BLK

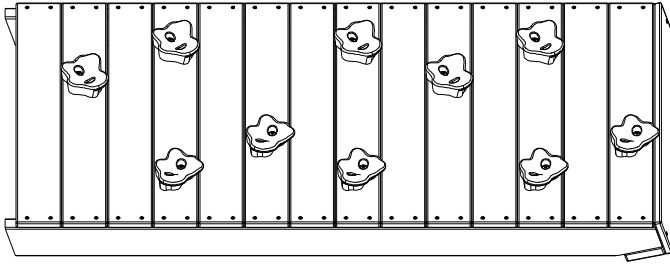

MUR D'ESCALADE ASSEMBLAGE

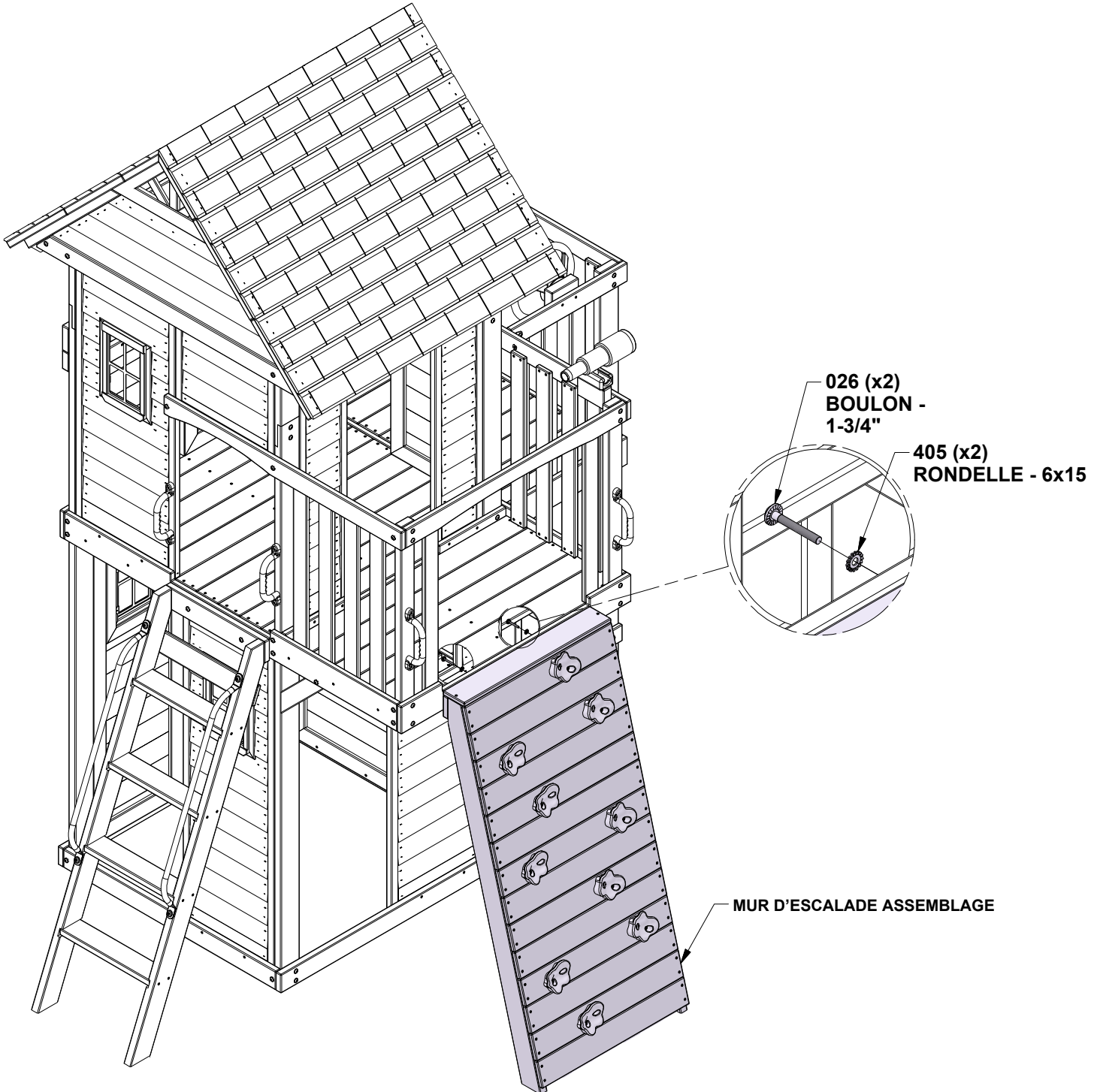

026 (x2)  
BOULON -  
1-3/4"

405 (x2)  
RONDELLE - 6x15

MUR D'ESCALADE ASSEMBLAGE

# ÉTAPE 54 - ASSEMBLAGE DE FORT

QTÉ	N° DE PIÈCE	DESCRIPTION
2	H100008	BOULON WH 5/16x1
2	H100074	ÉCROU EN T 5/16

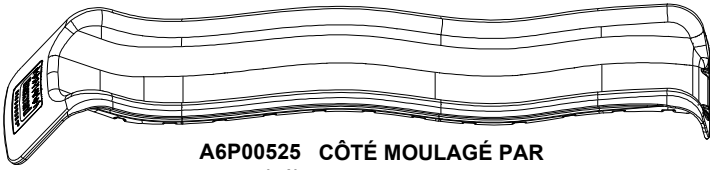

**CENTREZ LA GLISSIÈRE DANS L'OUVERTURE EN UTILISANT LES DIMENSIONS MONTRÉES. EN UTILISANT LA GLISSIÈRE COMME MODÈLE, PERCEZ (2) DES TROUS DE 3/8" [10mm] À TRAVERS LE PLATEAU POUR LE MATÉRIEL.**

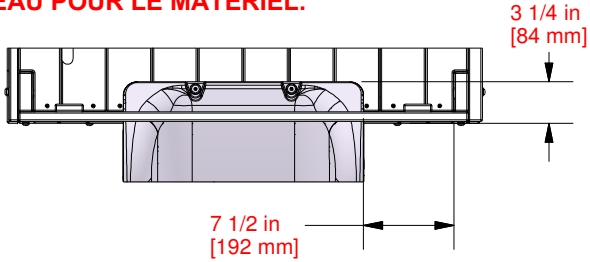

008 (x2)  
BOULON -  
5/16x1"

074 (x2)  
ÉCROU EN T - 5/16"

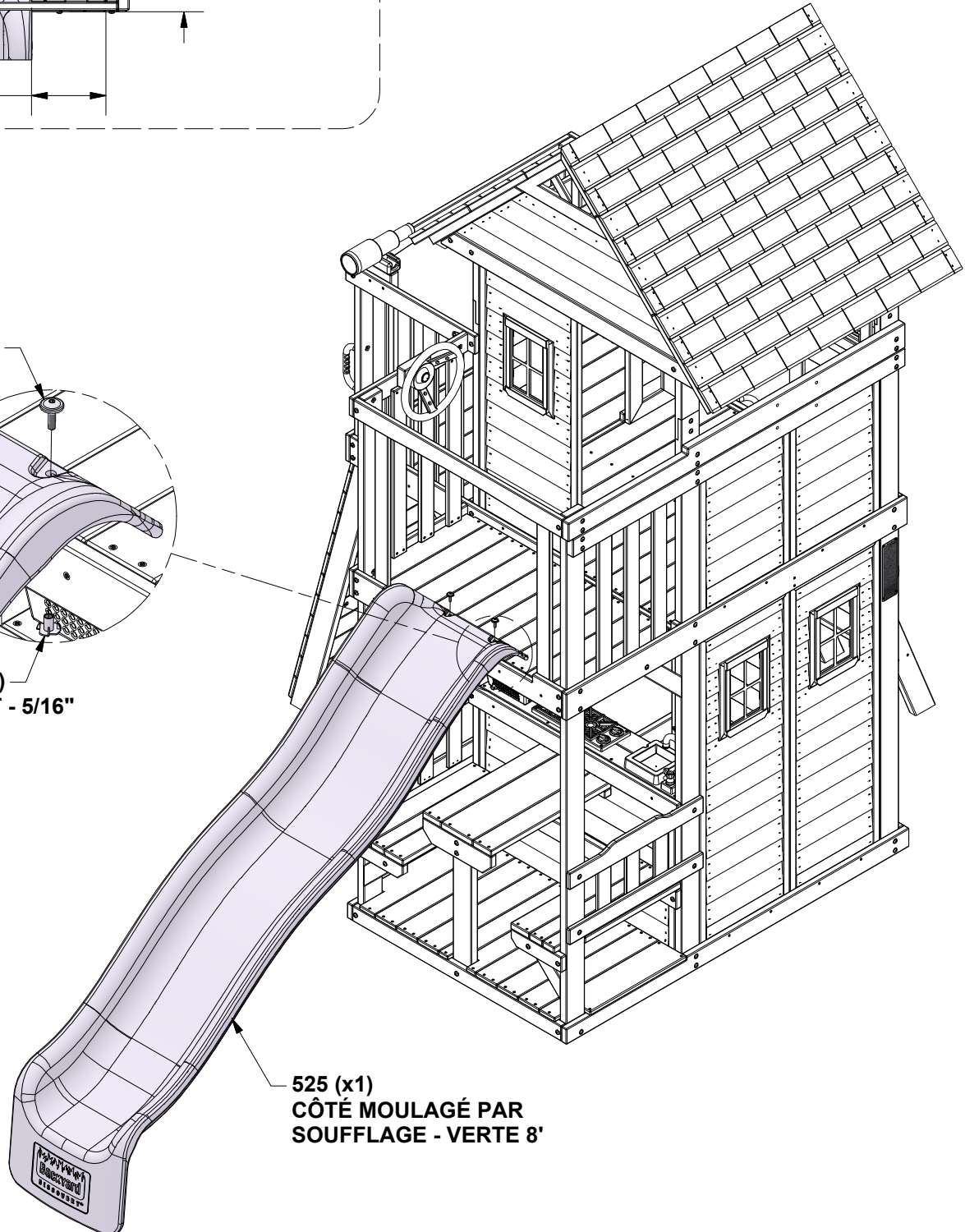

# ÉTAPE 55 - ASSEMBLAGE DE FORT

QTÉ	N° DE PIÈCE	DESCRIPTION
4	H100379	ÉCROU EN T 5/16 BLK
4	H100477	RONDELLE FENDUE 5/16 BLK
4	H100478	RONDELLE PLATE 8x27 BLK
4	H100498	BOULON HEX 5/16x1-1/2 - BLK

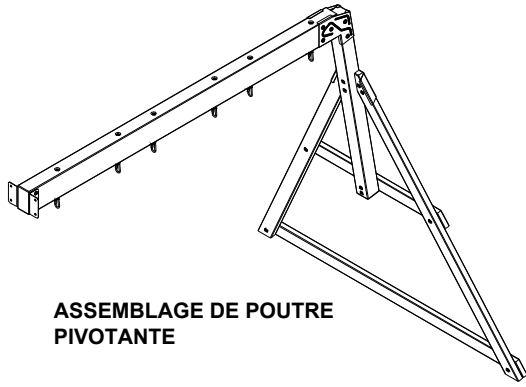

**INSTALLEZ LES ÉCROUS EN T DANS LE BOIS TOUT D'ABORD**

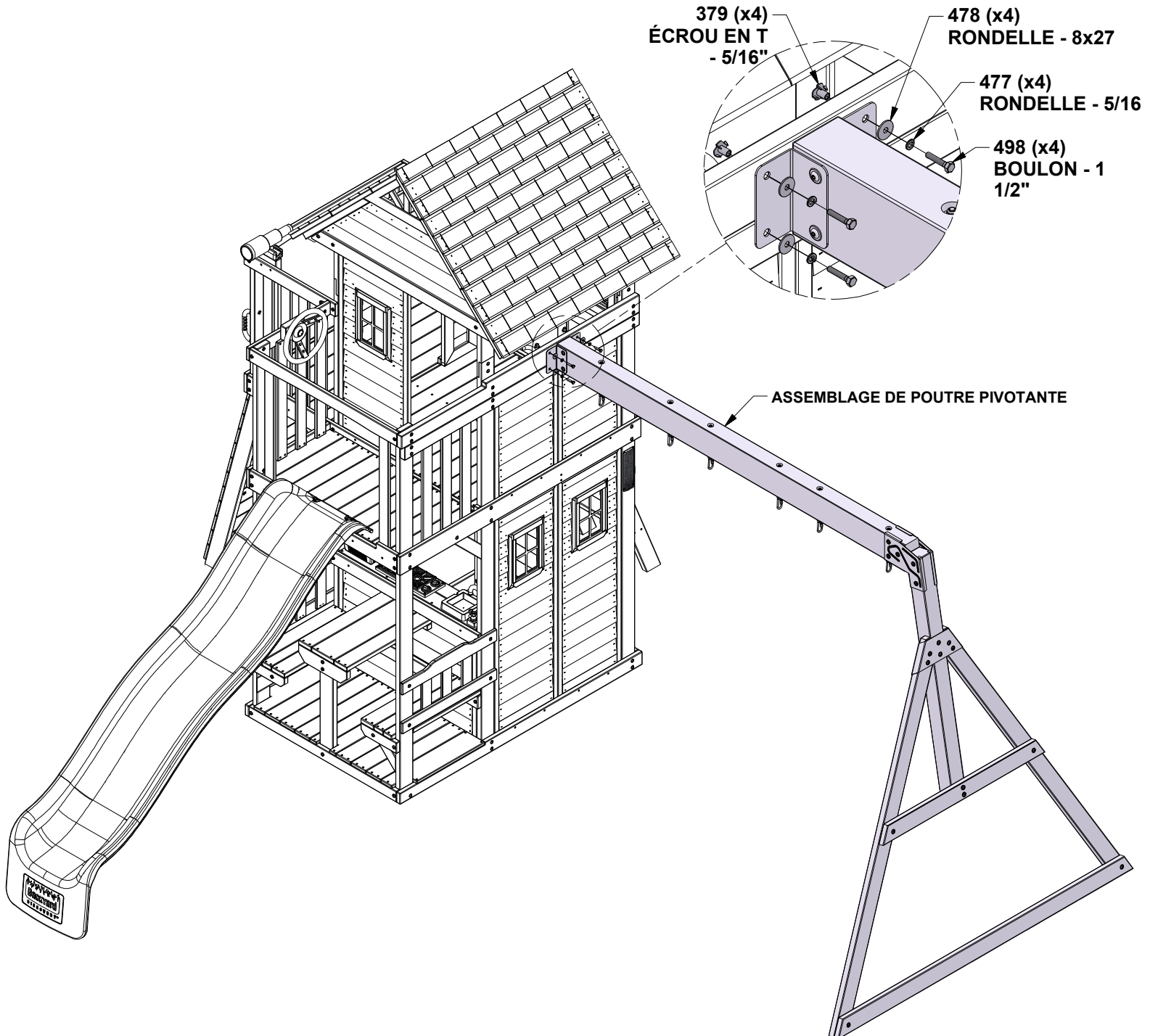

# ÉTAPE 56 - ASSEMBLAGE DE FORT



A6P00054 SIÈGE À BALANÇOIRE 22" VERTE  
(x2)

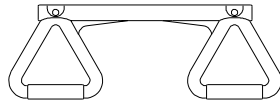

A6P00034 TRAPÈZE JAUNE  
(x1)



A100069 QUICK LINK  
(x6)

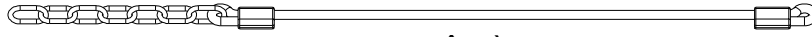

A100083 CHAÎNE À CORDE VERT 33"  
(x2)

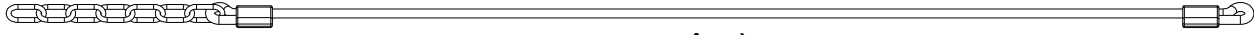

A100087 CHAÎNE À CORDE  
(x4) VERTE 51.25"

**LORS DE L'ACCROCHAGE DE VOS BALANÇOIRES, IL EST NÉCESSAIRE DE NE TAILLER QUE AUTOUR DE LA BOUCLE DE CHAÎNE SPÉCIFIQUE QUI PERMET AU BAS DU SIÈGE DE BALANÇOIRE (LORSQU'ON S'ASSOIT DESSUS) DE NE PAS ÊTRE PLUS BAS ALORS (35cm) 13 7/8 POUCHES DU SOL.**

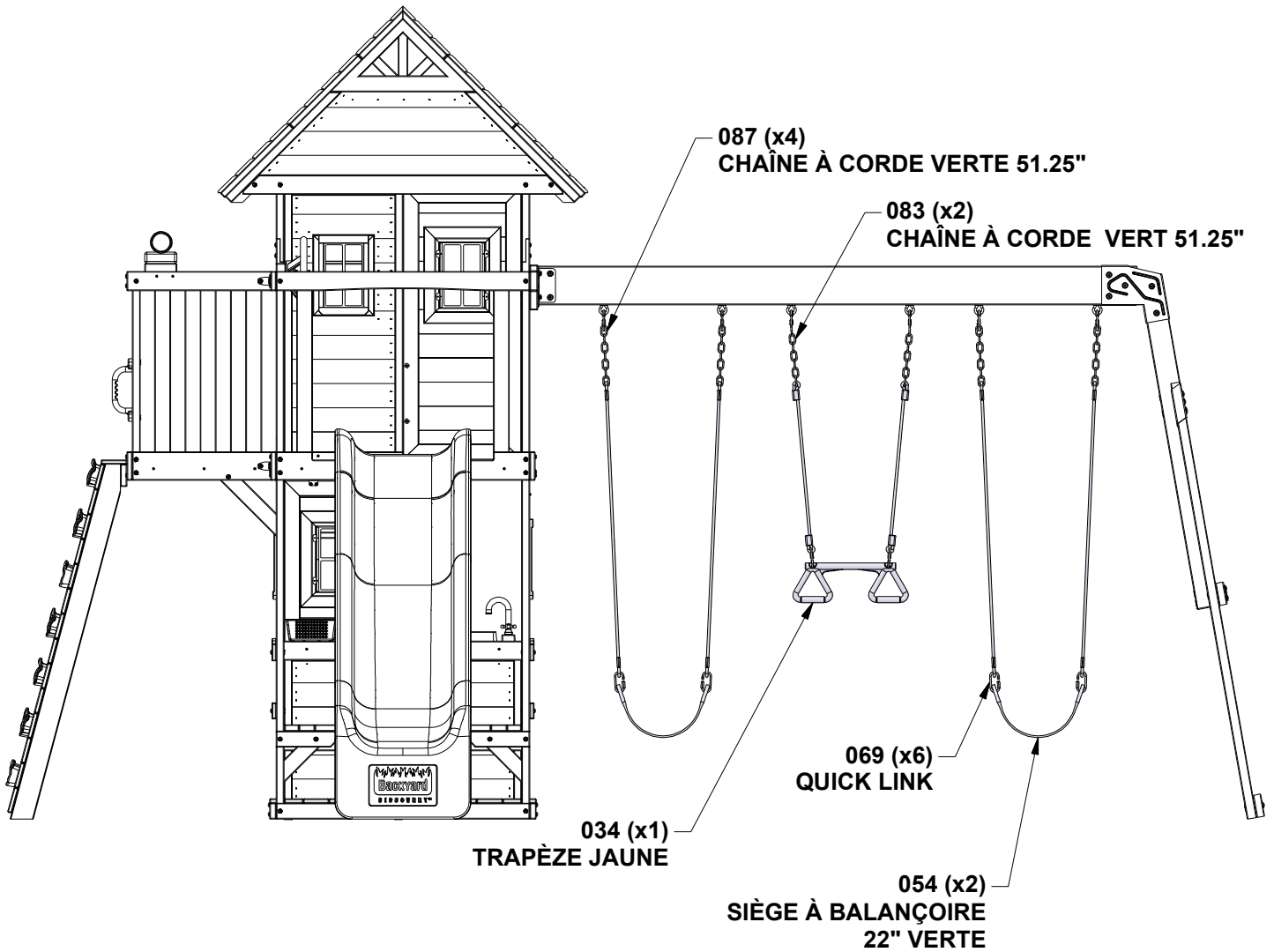

# ÉTAPE 57 - ASSEMBLAGE DE FORT

QTÉ	N° DE PIECE	DESCRIPTION
4	H100202	VIS PWH 8x5/8 BLK



A100164 ÉTIQUETTE LOGO  
(x1) BYD (LARGE)

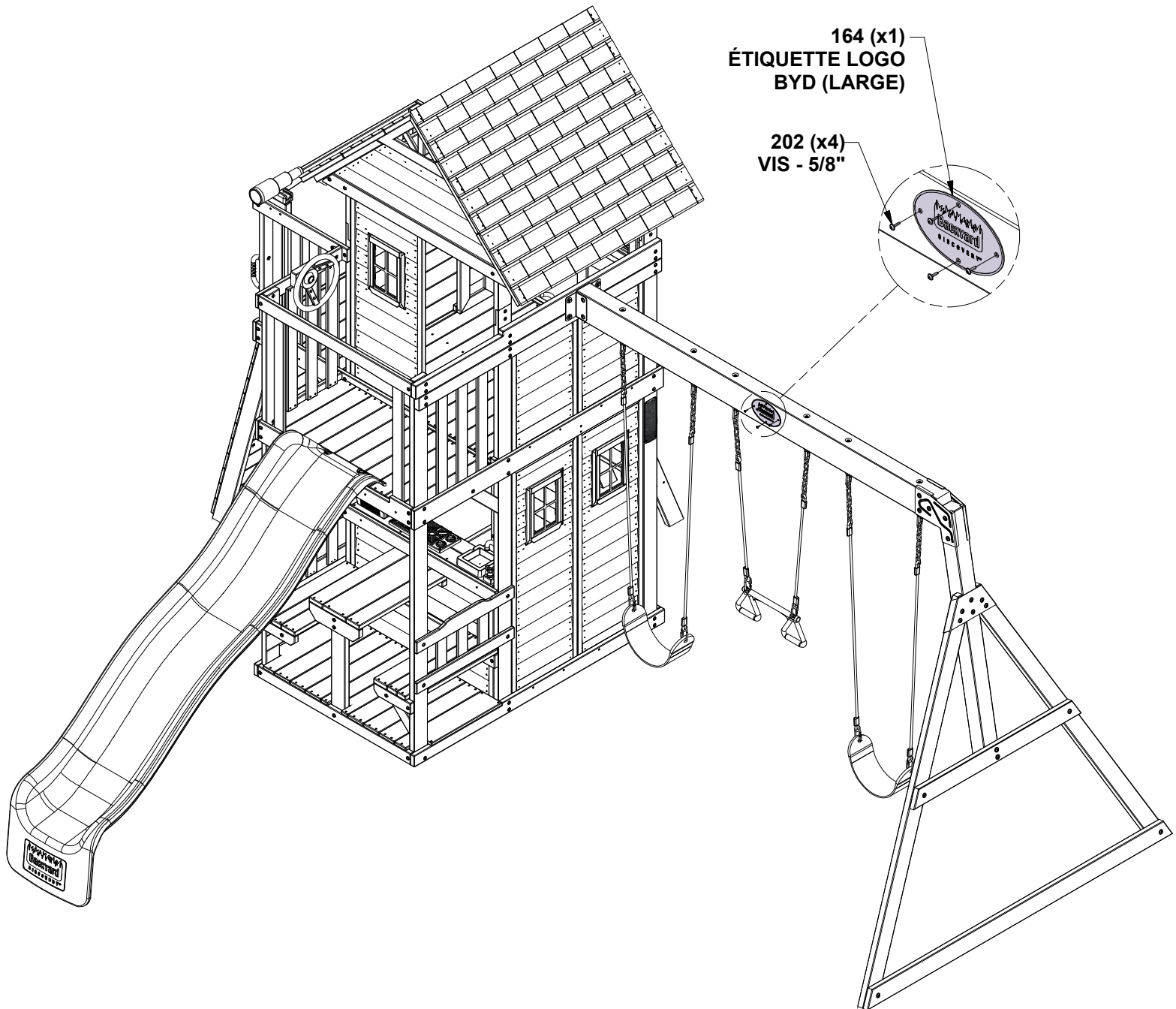

# ÉTAPE 58 - ASSEMBLAGE DE FORT

QTÉ	N° DE PIÈCE	DESCRIPTION
6	H100379	ÉCROU EN T 5/16 BLK
2	H100407	BOULON WH 5/16x1 1/2 BLK
4	H100459	BOULON WH 5/16x1 1/4 BLK



**TORDRE LE PIQUET DANS LE SOL LÀ OÙ IL EST INDICÉ.**

**EN UTILISANT LE PIQUET DE SOL COMME GUIDE, PERCEZ (1) UN TROU de 3/8" [10 mm] POUR LA QUINCAILLERIE.**

