

SONANCE

BEYOND SOUND

2-CHANNEL, 250-WATT POWER AMPLIFIER WITH DSP
UA 2-125 | UA 2-125 ARC
INSTALLATION AND SUPPORT MANUAL

TWO-CHANNEL DSP POWER AMPLIFIER

UA 2-125

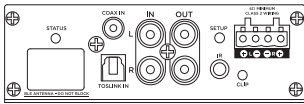

AUDIO CONNECTOR PANEL



POWER INLET PANEL

UA 2-125 ARC

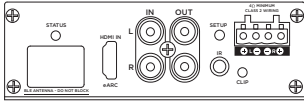

AUDIO CONNECTOR PANEL

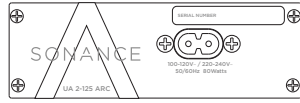

POWER INLET PANEL

TABLE OF CONTENTS

- 2 Box Contents
- 2 Introduction
- 2 Important Safety Information
- 3 Product Description
- 3 Placement
- 3 Unpacking and Record Keeping
- 4 Front and Rear Panel Connections
- 5 SonARC App Setup
- 5 Amplifier and Source Connections
- 5 Powering the Amplifier
- 6 Standard Stereo
- 6 Power Sharing Mode
- 7 IR Learning
- 7 Mounting the Amplifier
- 8 T-Nut and Din Rail Installation
- 8 Protecting Circuitry and LEDs
- 8 SonARC App Guidelines
- 14 Amplifier Power Requirements
- 14 Specifications
- 15 Troubleshooting
- 16 Warranty Statement

BOX CONTENTS

- (1) Quickstart Guide
- (1) Sonance UA 2-125 or UA 2-125 ARC Amplifier
- (1) Power Cord (region dependent)
- (2) Mounting Brackets
- (1) IR Receiver Module
- (1) Speaker Block Connector
- (4) M3 T-Nuts

INTRODUCTION

Thank you for selecting a Sonance UA 2-125 or UA 2-125 ARC amplifier. Sonance has over four decades of experience in premium distributed audio amplification. This amplifier has been precision engineered to provide maximum installation flexibility, low energy consumption, and audiophile sound in a compact form factor. Please take the time to carefully read through the manual, study the illustrations and system diagrams. This extra time can lead to trouble free operation and continued musical enjoyment.

READ THIS SECTION IN ITS ENTIRETY BEFORE ATTEMPTING USE OF THIS AMPLIFIER.

IMPORTANT SAFETY INSTRUCTIONS

Always follow these basic safety precautions when using your amplifier to reduce the risk of fire, electric shock, and injury to people or objects.

1. Read all the safety and operating instructions before operating the amplifier and retain them for future reference.
2. Adhere to all warnings and precautions listed on the amplifier and in the operating instructions.
3. Follow all operating instructions.
4. Never use the amplifier next to water.
5. Keep amplifier dry at all times.
6. Ventilation: situate the amplifier so that its location does not interfere with its proper ventilation.
7. Heat: situate the amplifier away from heat sources such as radiators, stoves, etc. (including amplifiers).
8. Grounding or Polarization: take precautions so that these attributes are not defeated.
9. Power-Cord Protection: route power supply cords so they will not be walked on or pinched by items.
10. Cleaning: use 'canned air' or wipe the amplifier with a soft cloth. Do not use solvents, as they may damage the amplifier.
11. Non-Use Periods: unplug the amplifier's power cord from the outlet when the amplifier will be left unused for a long period of time.
12. Moisture: do not expose the amplifier to dripping or splashing. Do not place objects filled with liquids (ex. vases, drinking glasses) on the amplifier.
13. Damage Requiring Service: have the amplifier serviced by a qualified service technician when the power cord or power supply is damaged, dropped, the enclosure is damaged, something has spilled into the amplifier, it has been exposed to rain, or the amplifier is not operating properly.

14. Servicing: do not attempt to self service the amp. Contact Sonance Technical Support for servicing options.
15. Power Requirement: do not connect the Sonance amplifier to the accessory outlet of any other component.

WARNING: The power mains plug serves as the amplifier’s disconnect device. The disconnect device shall remain readily operable during operation. To ensure that the disconnect device is easily accessible, the user should not place the amp in a confined area during operation.

16. Storms: to prevent damage to components, unplug all electronic equipment during thunderstorms.
17. Unplug by grasping the plug; do not pull on the cord.

WARNING: Any changes or modifications to this unit not expressly approved by the party responsible for compliance could void the user’s authority to operate the equipment.

FCC COMPLIANCE STATEMENT: This equipment has been tested and found to comply with the limits for a Class B digital device, pursuant to part 15 of the FCC Rules. These limits are designed to provide reasonable protection against harmful interference in a residential installation. This equipment generates, uses, and can radiate radio frequency energy and if not installed and used in accordance with the instructions, may cause harmful interference to radio communications. There is no guarantee that interference will not occur in a particular installation. If this equipment does cause harmful interference to radio or television reception, which can be determined by turning the equipment off and on, the user is encouraged to try to correct the interference by one or more of the following measures:

- **Connect the equipment into an outlet on a circuit different from that to which the receiver is connected**
- **Consult the dealer or technician for help**
- **Reorient or relocate the receiving antenna**
- **Increase distance between the equipment and receiver**
- **Disconnect, then reconnect all cables**

PRODUCT DESCRIPTION

UA 2-125 | UA 2-125 ARC is a high power 2-channel audio amplifier equipped with advanced DSP functionality, capable of delivering an enhanced user experience with perfect matching to other Sonance speaker products. HDMI or S/PDIF (coaxial or Toslink) in addition to Stereo Analog Line Inputs and Line Outputs provide reliable connectivity. Specific equalization presets allow multiple speaker types and acoustic environments to easily be set-up and optimized within minutes. Features the SonARC Setup and Control App to link via short-range wireless connectivity to securely configure the device. The amplifier has automatic protection features to safeguard against overload, low impedance load, thermal overload and over/under power voltage situations.

PLACEMENT

The amplifier should be placed in a dry, non-condensing environment with ventilation. Locate the amplifier so it is completely isolated from temperature extremes, rain, snow, direct sunlight, and atmospheric contaminants. Do not locate the amplifier outdoors. Any moisture related damage (such as from condensation) is not covered by the factory warranty. Locate the amplifier on a shelf or at the lowest place in a rack that has good circulation of fresh air to dissipate heat. The amplifier can be placed into a back box behind a television display or other enclosure with little ventilation as long as the ambient temperature does not exceed 35-degrees Celsius.

UNPACKING AND RECORD KEEPING

Save the carton and packing inserts for future safe transport in case the amplifier is moved or requires shipping for repair. Before proceeding with installation, locate the serial number on the rear panel of the unit and note it here for future reference:

S/N: _____

Date of Sale: _____

Dealer Name: _____

Contact Info: _____

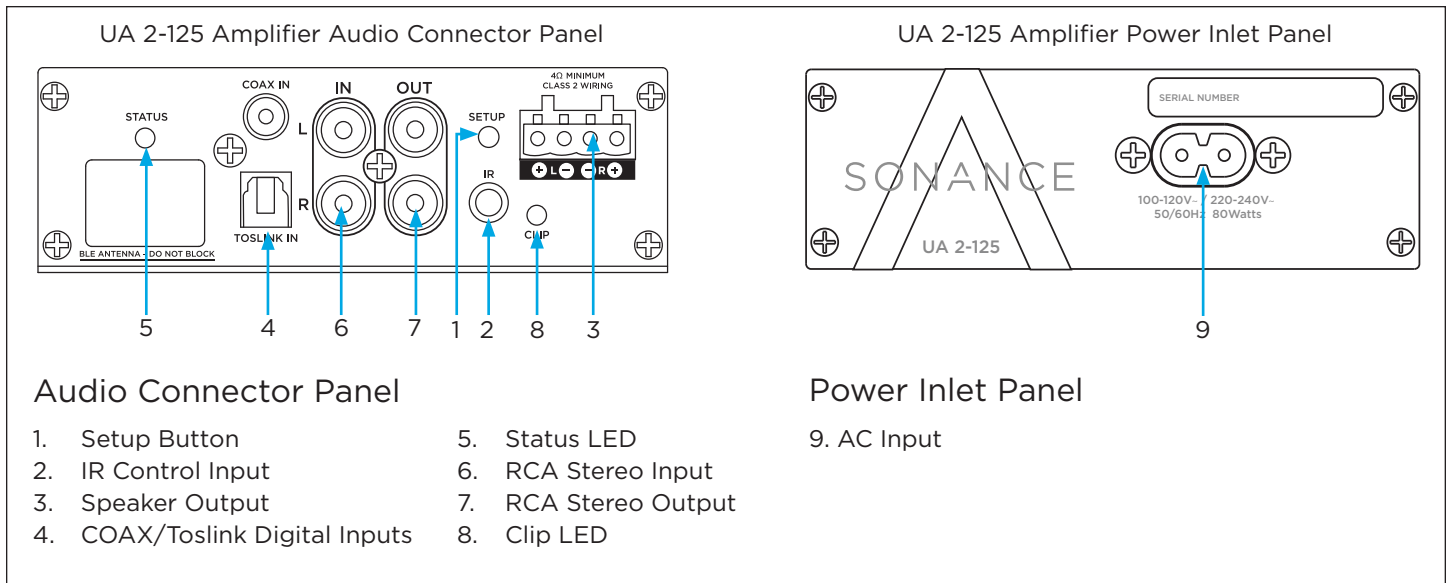

Audio Connector Panel

- | | |
|--------------------------------|----------------------|
| 1. Setup Button | 5. Status LED |
| 2. IR Control Input | 6. RCA Stereo Input |
| 3. Speaker Output | 7. RCA Stereo Output |
| 4. COAX/Toslink Digital Inputs | 8. Clip LED |

Power Inlet Panel

9. AC Input

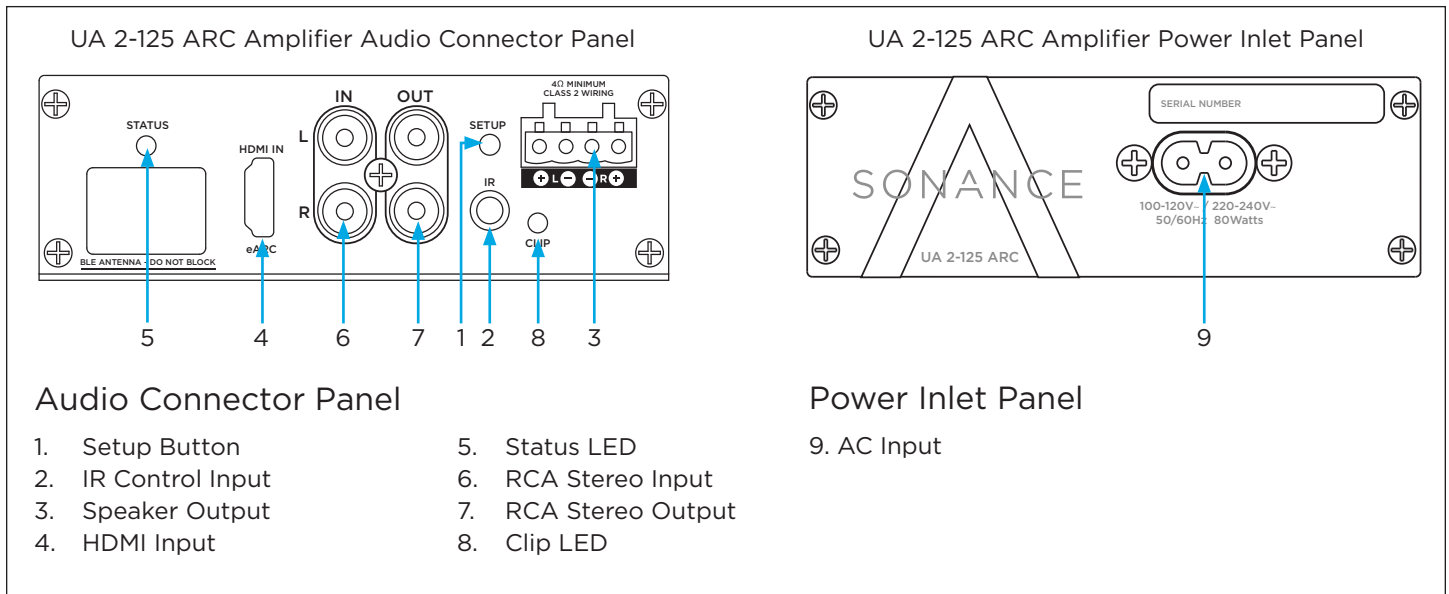

Audio Connector Panel

- | | |
|---------------------|----------------------|
| 1. Setup Button | 5. Status LED |
| 2. IR Control Input | 6. RCA Stereo Input |
| 3. Speaker Output | 7. RCA Stereo Output |
| 4. HDMI Input | 8. Clip LED |

Power Inlet Panel

9. AC Input

POWER INLET PANEL

POWER CORD

The UA 2-125 and UA 2-125 ARC amplifiers feature a removable power cord. Plug the female end of the power cord into the Power Cord Connector on the amplifier rear panel (9). The male end of the power cord is to be plugged into a wall socket at a later step.

AUDIO CONNECTOR PANEL

SPEAKER CONNECTIONS

The removable speaker block connectors (3) used on the amplifier accept up to a 12-gauge wire. Follow the connection layout on the rear panel of the amplifier. Make sure no bare wires come in contact with the amplifier chassis. Audio connector panel provides connectivity to signal sources and amplifier speaker output. Depending on model choice, the digital inputs supported are 2-channel PCM (S/PDIF) over **COAX or Toslink for UA 2-125** and **HDMI for UA 2-125 ARC** (4), while both support analog line input (6) and output (7).

Pressing the setup button (1) will reactivate the internal radio if it has been turned off in the settings using the SonARC control app.

Status Indicator (5) shows the presence of power and the current operational state of the amplifier.

Clip indicator (8) shows when the amp is being overdriven.

Both models feature a 3.5mm IR port (2) for connecting an infrared receiver. This enables control using common IR remote controls.

STATUS INDICATOR LED	
GREEN	Analog Input Active
ORANGE	Standby
RED FLASHING	Protection State; Amp Overdriven or Clipping
BLUE	IR Learning Mode or Short-Range Wireless Radio Reactivated
WHITE	Digital Input Active
PURPLE	Mix Mode (Both Analog and Digital Inputs Active)

SONARC APP SETUP

UA 2-125 amps are configurable via iOS app or Android app over short-range wireless connectivity. To enable this feature, a smart device is required (iOS or Android) with Bluetooth® turned on. Download the “SonARC for Sonance UA Series” app from the iOS or Google Play store or scan the appropriate QR Code to download.



CONNECT TO AMPLIFIER

1. Once the app is loaded onto a device, open/launch the app within range of the amplifier (up to ten meters away, depending on obstructions).
2. The amplifier should automatically send signal to appear in the app home screen. If the amp is not visible in the app, press and release the SETUP button on the audio connector panel of the amplifier. The indicator LED will blink blue while it sends signal to nearby devices.
3. The amp will appear listed in the app homepage. Drag the app screen down and release to refresh the search if no amplifier is listed. The app home screen will also display a list of previously connected amplifiers within signal range.

NOTE: When more than 5 UA amplifiers are within range, it is recommended to either turn off the BLE Radio within each amp (located under GENERAL) except for the one to be configured, or connect power to and configure only one amplifier at a time.

4. When multiple amplifiers are displayed on the page, pressing the sound icon in the blue amp tile will trigger the amplifier to send pink noise signal to the speakers to help identify (see Figure 1).

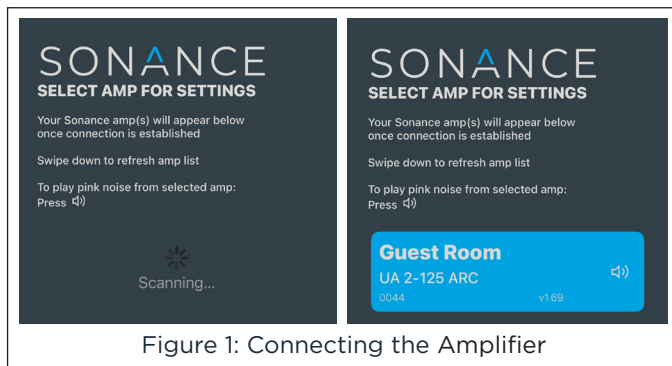

Figure 1: Connecting the Amplifier

5. Once the amp appears in the app, tap the selected amp on screen to begin setup and configuration.

*The Bluetooth® word mark and logos are registered trademarks owned by Bluetooth SIG, Inc.

6. See the Amplifier Configuration Chart for recommended basic settings. Proceed with remaining installation steps. Return to the SONARC APP GUIDELINES section of the manual for full features and settings.

AMPLIFIER CONFIGURATION	
Suggested Settings for Initial Configuration of Amp and Sources	
GENERAL	
Autosense	Always ON
VOLUME	
No setting changes for eARC sources; Set amp volume to “fixed” for most other source applications	
INPUT	
Default Secondary	As Required
Source Switching Mode	Duck/Mute/Mix
Input Trim	0 dB (or as required to match source signal)
AMP & DSP	
Output Trim	0dB (8 ohm) -3dB (4 ohm)
DSP Preset	None Applied

POWERING THE AMPLIFIER

The UA 2-125 and UA 2-125 ARC feature a removable power cord. The amplifier will automatically start when power is applied. The Status LED will illuminate GREEN when connected to power. If the electrical service is subject to frequent sags, spikes or brownouts, a power conditioner designed for use with high fidelity equipment should be employed to protect the amp.

IMPORTANT: Do not plug the amp’s power cord into a convenience outlet on any other audio or video component.

SOURCE CONNECTIONS

UA 2-125: Features stereo analog line input and S/PDIF (Coax and Toslink) digital input signal types. Connect to either the Coax or Toslink (optical), but not both. Only one can be used at a time. The UA 2-125 will automatically detect which one is being used.

UA 2-125 ARC: Features stereo line input and HDMI digital input signal types. Use a high-quality HDMI cable certified to HDMI 2.1 to connect to a TV. Plug the one end of the HDMI cable into the TV using a port labeled “ARC” or “eARC”, and plug the other end into the UA 2-125 ARC’s HDMI IN port. Ensure that audio type is set to “PCM” in the settings of the connected TV. For most TVs, navigate within the TV settings menu to “audio” or “sound” to find digital audio output format (“Digital Audio Out”, “Audio Format”, or “HDMI Audio Format”. Select “PCM”. Press “OK” or “Enter” to confirm the selection.

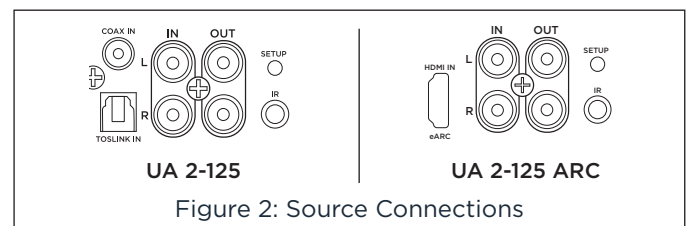

Figure 2: Source Connections

SPEAKER CONNECTIONS

For optimal performance, use pure copper speaker wire that complies with fire rating codes. Be sure to check local codes governing wire that may be installed within walls or ceilings. The amplifier uses speaker block connectors that can accommodate up to 12 gauge wire (see Figure 3).

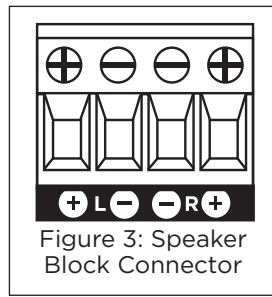

Figure 3: Speaker Block Connector

STANDARD STEREO

For a standard speaker pair setup, connect speaker wire from the left speaker to the left portion of the speaker block connector, inserting the stripped end of the positive strand to the positive port and the stripped end of the negative strand to the negative port. Repeat these steps for the right speaker wire, connecting the positive to positive and negative to negative on the right ports of the speaker block connector. Plug the speaker block connector into the speaker output port on the amplifier.

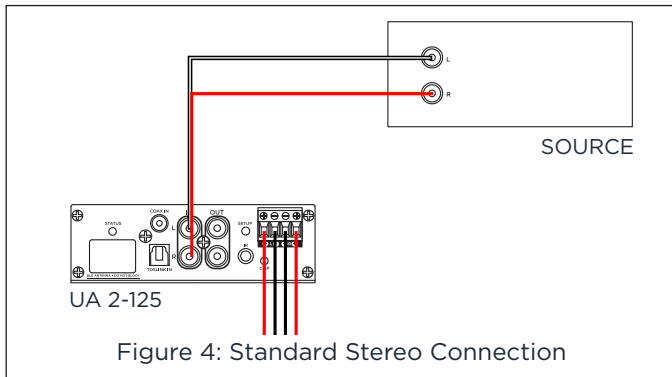

Figure 4: Standard Stereo Connection

POWER SHARING MODE

UA 2-125 amps can be installed and set up for Power Sharing Mode to achieve a max 250W power by leveraging full power from a single channel output. This mode is recommended to support subwoofers or speakers that require high power. To deploy Power Sharing Mode for a pair of speakers, two amplifiers will be required. Power Sharing Mode for one subwoofer would require one amplifier.

SPEAKER OUTPUT CONNECTIONS

POWER SHARING MODE: Speaker wire connection must be made to the positive and negative wire ports on the speaker block connector on the LEFT CHANNEL ONLY. Leave the right channel ports empty (see Figure 5).

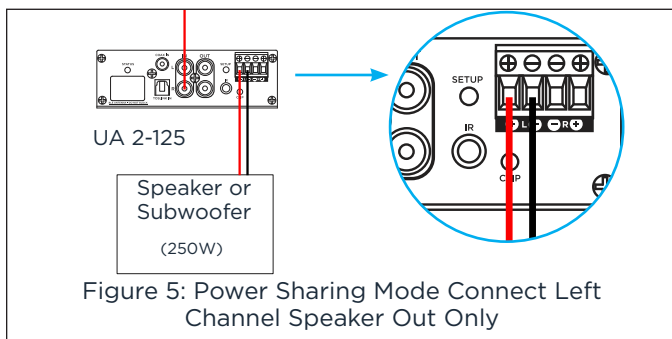

Figure 5: Power Sharing Mode Connect Left Channel Speaker Out Only

SOURCE INPUT CONNECTIONS

POWER SHARING MODE: When connecting a source for a subwoofer to a UA 2-125/UA 2-125 ARC amplifier in Power Sharing Mode, connect the inputs for both Left and Right channels and set the Amp Output Channel Configuration in the SonARC App to Sum Mono to L Output configuration (see Figure 6). Remember to set the sub's DSP filter (see Page 9).

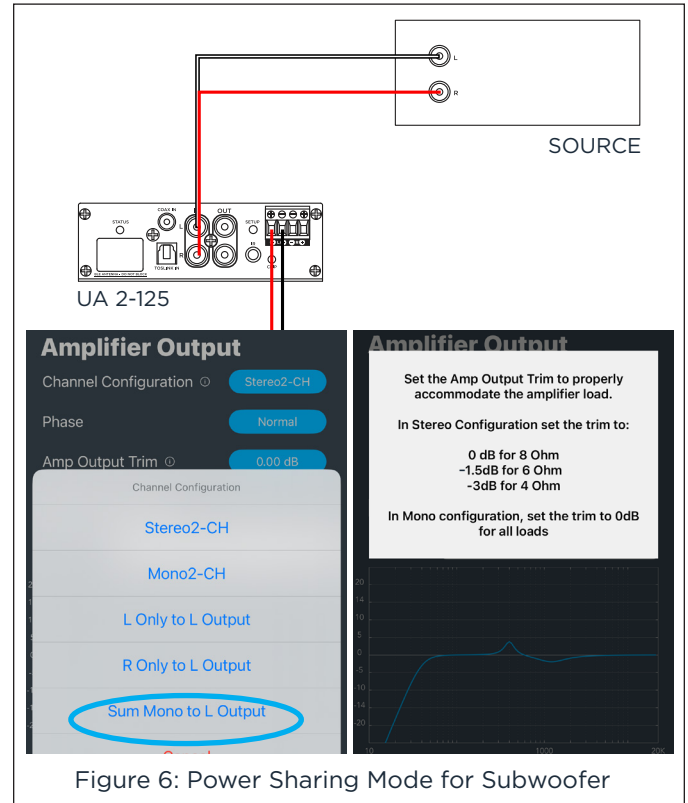

Figure 6: Power Sharing Mode for Subwoofer

When connecting a source for a pair of speakers with a pair of UA amps in Power Sharing Mode, connect the Left input to the amp designated for the Left speaker and the Right input to the amp designated for the Right speaker to divide the stereo signal to the two amps that feed each stereo speaker. In the SonARC app, under Amp & DSP | Amplifier Output, set each amp Channel Configuration to "L Only to L Output" for the Left Channel Amplifier, and "R Only to L Output" for the Right Channel Amplifier (see Figure 7 and 8).

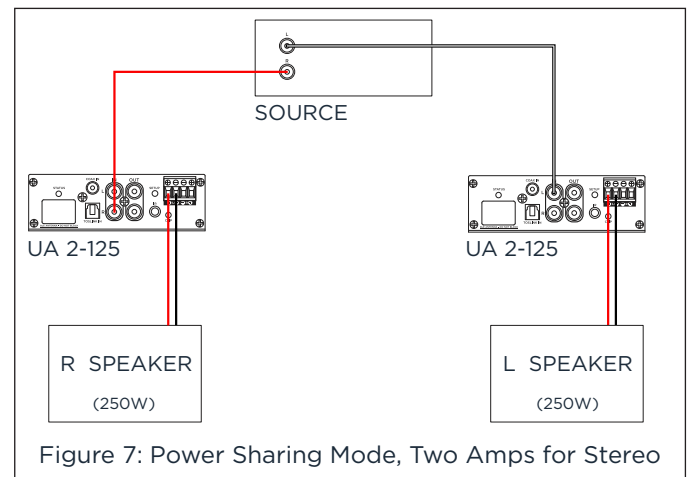

Figure 7: Power Sharing Mode, Two Amps for Stereo

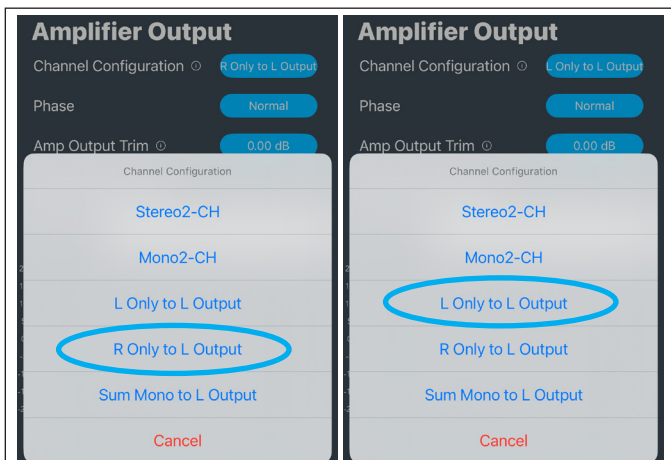

Figure 8: Power Sharing Mode, Two Amps for Stereo

IR LEARNING

This amplifier is equipped with a 3.5mm IR input jack that allows for command learning from third-party remote controls. Follow the steps below to teach the amplifier IR commands for functions such as volume control, power, and input selection.

1. Insert a 3.5mm mono cable into the IR jack labeled "IR" on the connections inlet panel
2. Launch the SonARC app and select the amplifier from the listed amps.
3. Tap the IR LEARNING section from the list to access IR programming for power, volume, and mute.
4. Tap "learn" for a desired command. The indicator LED will blink Blue while waiting for the remote command.
5. Press the button on the remote while aiming at the IR emitter to program the button to perform the command.
6. Once the signal is received, the indicator LED will illuminate green.
7. REPEAT FOR ADDITIONAL COMMANDS. Continue teaching the amplifier additional commands by repeating the previous step.
8. Use the remote to verify that the amplifier responds to the newly learned commands.

NOTE: When IR 3.5mm cable is inserted into the IR port, HDMI CEC control signals from the TV are disabled to prevent conflicts with the IR remote control commands.

For most UA 2-125 ARC applications, the IR receiver is not needed. Your TV can send remote control commands over the HDMI cable using CEC. This works very well with most TVs. We strongly recommend using CEC control whenever possible. Be sure CEC functionality is turned on in your TV's settings and that the IR receiver is not plugged into the IR port.

MOUNTING THE AMPLIFIER

The UA 2-125 and UA 2-125 ARC amps feature a T-slot chassis design for flexible mounting and placement.

MOUNTING BRACKET INSTALLATION

The included ambidextrous mounting brackets can be configured for either bottom-mount or top-mount (inverted) installation.

1. **PREPARE THE BRACKETS:** Begin by loosening the screws on each bracket arm (there are two screws per arm) to provide clearance for positioning. Do not fully remove the screws.
2. **INSERT BRACKETS INTO CHASSIS:** Slide each bracket into the T-slot openings at both ends of the chassis. The brackets should slide smoothly into position.
3. **POSITION FOR MOUNTING ORIENTATION:** For bottom-mount installation (amplifier right-side up): Position the bracket arms in the T-slot on the bottom of the chassis at both the front and rear ends (see Figure 9). For top-mount installation (amplifier inverted): Position the bracket arms in the T-slot on the top of the chassis, ensuring the flat portion of the bracket arms will sit flush against the mounting surface when inverted

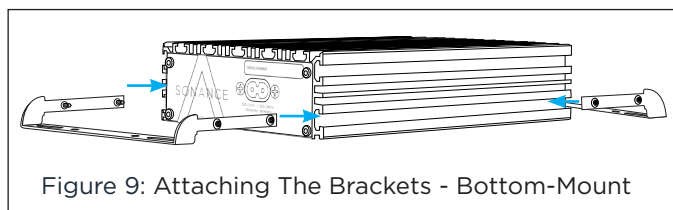

Figure 9: Attaching The Brackets - Bottom-Mount

4. **SECURE THE BRACKETS:** Once the bracket arms are properly positioned and all screws are aligned with the chassis T-slots, tighten each screw to secure the mounting brackets firmly in place.
5. **MOUNT TO SURFACE:** Position the amplifier with the brackets flush against the desired

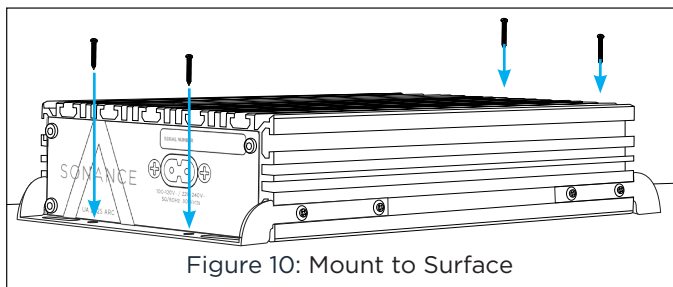

Figure 10: Mount to Surface

mounting surface. Ensure adequate clearance for the connection panel and power inlet panel to accommodate all cable connections. Secure the amplifier to the mounting surface using appropriate screws through the bracket mounting holes (minimum four screws recommended) see Figure 10.

IMPORTANT: Before mounting, ensure all audio and power connections have been made and verified as outlined in the previous sections. Verify that the selected location provides proper ventilation as outlined in the PLACEMENT section.

T-NUT INSTALLATION

The UA amplifiers include four T-Nuts that can slide into the T-slot chassis in any desired slot and in any desired orientation to attach to any universally compatible T-slot hardware. Use the screws from the included amp brackets to secure the T-nuts into position.

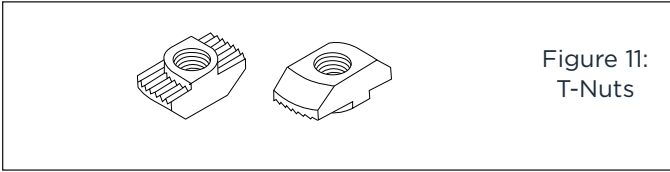

DIN RAIL INSTALLATION

For DIN rail mounting applications, compatible DIN rail adapters can be used with the T-slot chassis design. DIN rail hardware and information is available online and is not specific to Sonance.

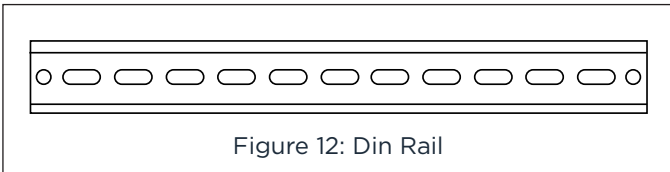

NOTE: Always verify that the mounting method selected can safely support the amplifier's weight (UA 2-125: 5lbs 4oz / UA 2-125 ARC: 5lbs 6oz) and that proper ventilation is maintained in the final installation location.

PROTECTION CIRCUITRY

The amplifier has a multi-stage protection system to prevent damage to your amplifier and speakers.

AMPLIFIER CHANNEL PROTECTION

If a channel encounters a short-circuit or extremely low impedance, the amplifier will self-protect.

STATUS INDICATOR LED

- **GREEN:** analog input selected
- **ORANGE:** standby
- **RED FLASHING:** protection state; amp overdriven/clipping
- **BLUE:** setup mode; short-range wireless or IR learning
- **WHITE:** digital input selected
- **PURPLE:** mix selected

The status indicator always displays the present state of the amplifier, unless set to ten second timeout. These settings can be adjusted in the Sonance SonARC App under "General". Within the app, LED Level can be set to Low, Medium, or High, and LED Timeout can be set to Always On (default setting) or ten sec.

CLIP INDICATOR LED

When being overdriven, audio peaks display as RED flashes. If this situation occurs, the amp is being overdriven and the volume control needs to be reduced until the peaks no longer cause illumination of the Clip Indicator.

SONARC APP GUIDELINES

Detailed descriptions and setting information for SonARC for Sonance UA Series App. Reference the guideline chart on the following pages for descriptions and explanations of the SonARC UA App settings and features.

GENERAL PAGE

Allows naming of the amplifier and the basic configuration of power saving Auto Sense operation, how long it waits before sleeping if no signals are present to be amplified, how long the LED indicators will illuminate (automatically turn off after a preset time or always on), if the BLE radio link is enabled (it is required for controlling the amplifier but can be turned off afterward) see Figure 13.

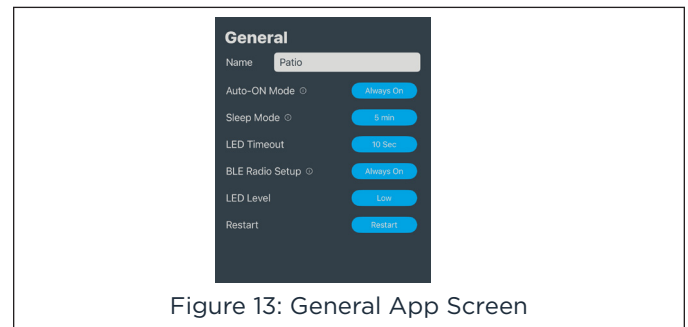

VOLUME PAGE

Volume adjustments, limit setting, turn-on volume setting, and mute.

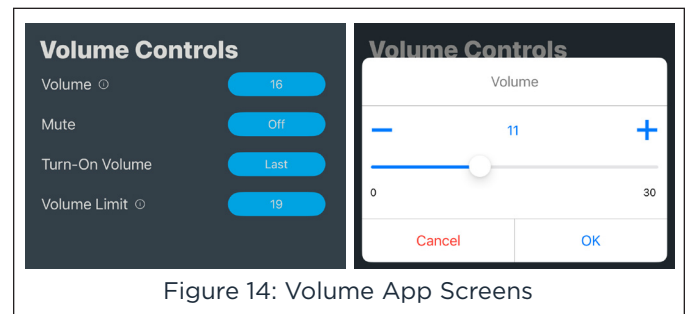

INPUTS PAGE

Use the Input Trim setting to match the input sensitivity of the UA 2-125 to the maximum signal level of the connected source. **Digital sources** are almost always referenced to OdBFS (Full Scale). Leave this set to OdB unless 1) you know that the digital source has built-in attenuation, 2) you need to adjust relative source levels for mix mode, or 3) as directed by the Sonance tech support team.

For **Analog sources**, the default input trim setting is OdB and corresponds to a maximum analog signal level of 2Vrms. Each additional 6dB of Input Trim gain corresponds to a matching signal with half the amplitude:

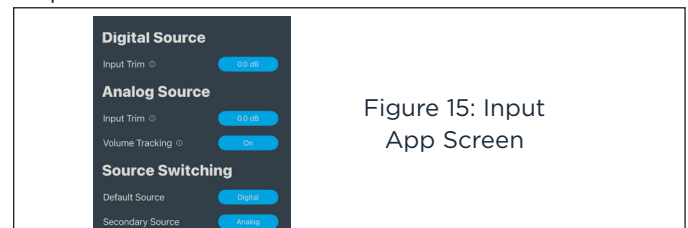

* 0dB Input Trim gain: 2Vrms max signal
 * 6dB Input Trim gain: 1Vrms max signal
 * 12dB Input Trim gain: 500mVrms max signal
 * 18dB Input Trim gain: 250mVrms max signal
 * 24dB Input Trim gain: 125mVrms max signal
 Do not set the Input Trim gain to a setting higher than needed to match your source signal level. Doing so can cause the input signal to be clipped, leading to severe distortion and potential speaker damage.

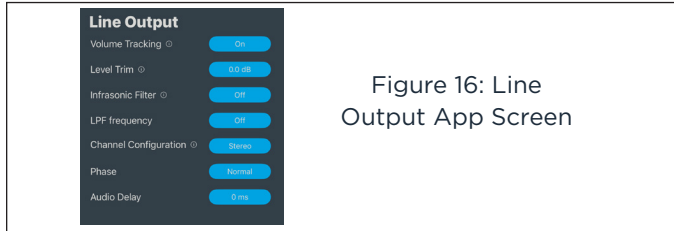

Figure 16: Line Output App Screen

Volume tracking on or off for flexibility for control within the app or control at the analog source. Configuration of which input signal (digital or analog) is going to be the primary source and which is going to be the secondary source for automatic switchover and mixing/ducking and muting modes. For Ducking and Mute modes, the primary signal is either muted or ducked by the appearance of a signal on the secondary channel. There is also adjustability of switching hold time for muting and ducking.

LINE OUTPUT PAGE

Settings for managing line output behavior for applications like daisy-chaining multiple amplifiers for multiple pairs of speakers or outputting to an active subwoofer. Turn on or off volume tracking, adjust level trim, infrasonic filter, channel configuration, phase, and audio delay.

AMP & DSP PAGE

AMPLIFIER OUTPUT -> CHANNEL CONFIGURATION:

1. 2-channel stereo (L & R) mode (2 x 125 watts).

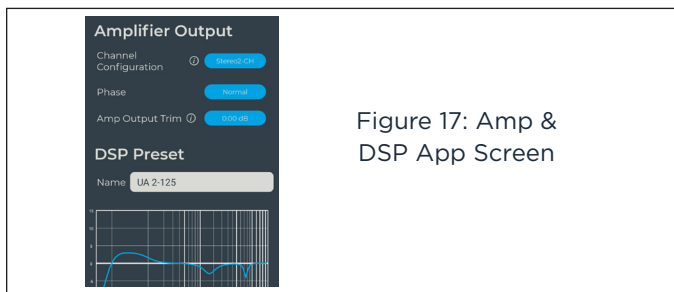

Figure 17: Amp & DSP App Screen

2. Single Channel Power Sharing (L) Mode (1 x 250 watts). For Power Sharing mode, the Left channel output delivers up to 250 watts into a 4ohm load.. The Channel Configuration can be set for Sum Mono to L Output, L Only to L Output, or R Only to L Output (see Power Sharing Mode section of the manual for connection details). This setting allows for control of source channel routing to the Left Output. Use L Output settings to get 250w single channel power into a single 4 ohm load.

OUTPUT TRIM

For most installations, you do not need to adjust the output trim in the SonARC App. Leave the output trim setting at 0dB (default) for stereo 8Ω or single channel (8Ω, 6Ω, or 4Ω) operation.

When driving stereo lower impedance loads, adjust the output trim in the SonARC App to ensure optimal performance:

OUTPUT TRIM		
LOAD IMPEDANCE	# CHANNELS	OUTPUT TRIM SETTING
8Ω, 6Ω, or 4Ω	1	0dB
8Ω	2	0dB
6Ω	2	-1.5dB
4Ω	2	-3dB

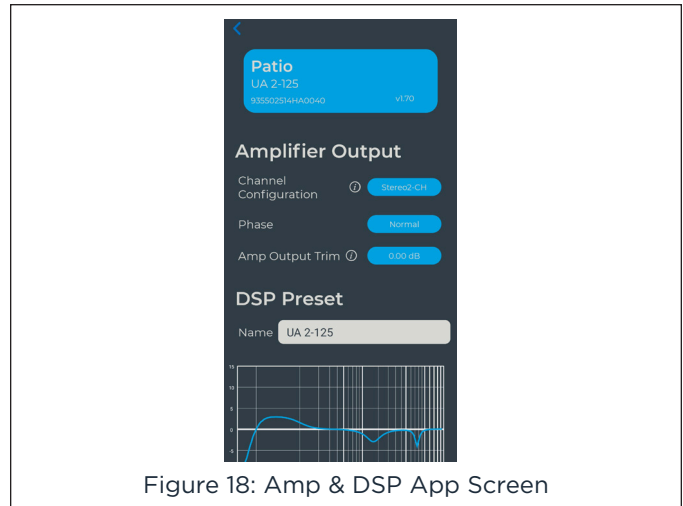

Figure 18: Amp & DSP App Screen

DSP

DSP equalization curves may be applied to the audio signal to compensate the magnitude and frequency response as desired and the inbound audio signal can be delayed 30 milliseconds.

Sonance has an extensive library of DSP EQ curves and downloadable presets.

Downloading Presets from the DSP Library:

Tap “download” to browse hundreds of Presets for various Sonance and James speaker and subwoofer models. Sections within the library can be tapped to collapse and expand by product category. Select the desired preset file to initiate download. Tap the back arrow to return to the list of saved presets.

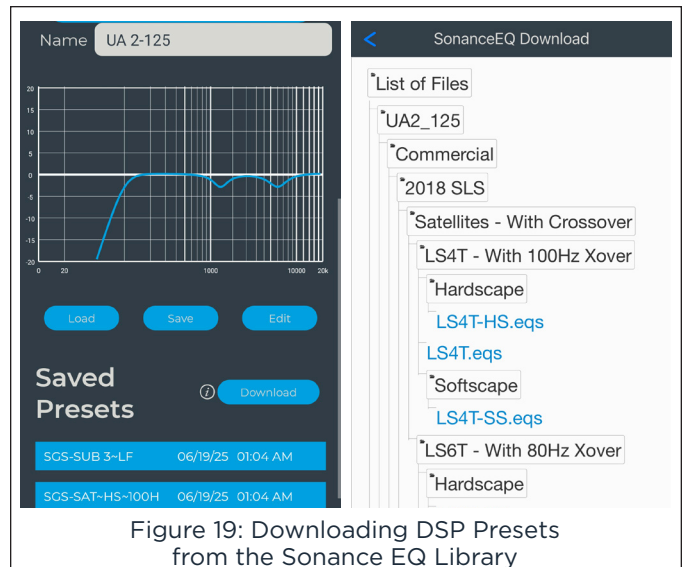

Figure 19: Downloading DSP Presets from the Sonance EQ Library

**DSP
LOADING PRESETS**

Tap to select a profile from the list of stored presets, then tap “load” to load the DSP Preset.

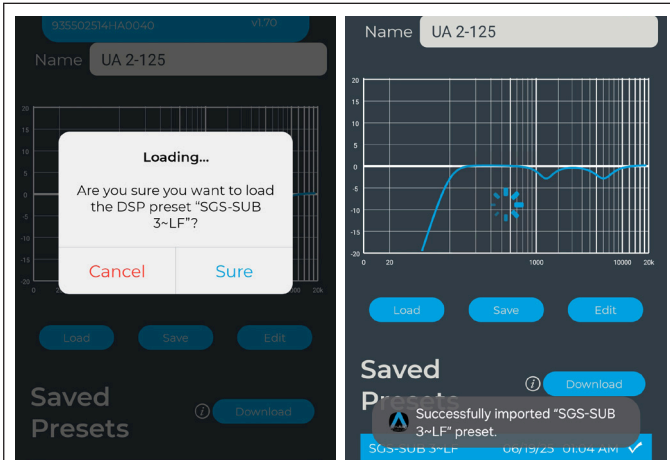

Figure 20: DSP App Screens

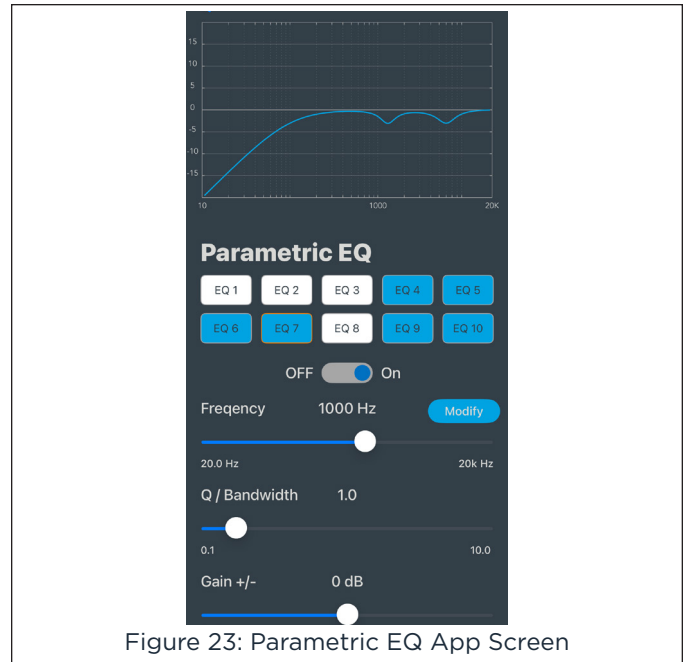

Figure 23: Parametric EQ App Screen

**DSP
SAVING PRESETS**

When making adjustments to a loaded DSP Preset profile, a loaded DSP profile can be named and saved to the Saved Presets list. Edit the name in the text field, tap “Save” and the profile will appear in the Saved Presets list for future recall.

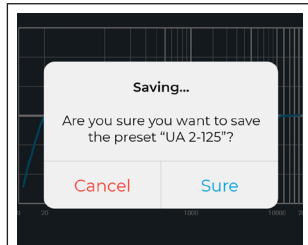

Figure 21: Saving DSP Presets

**DSP
DELETING SAVED PRESETS**

To remove DSP Preset profiles from the Saved Presets list, tap and hold the profile. A pop up window will appear asking “Are you sure you want to delete the profile/preset?” Confirm the deletion by selecting “Yes”, or select “Cancel” to keep the profile in the Saved Presets list.

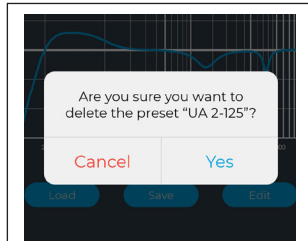

Figure 22: Deleting Saved Presets

**DSP
EDITING PRESETS**

The SonARC app allows for robust editing within DSP presets. To edit, first download and load a DSP EQ Preset from the DSP EQ Library in the app. Once a preset is loaded, select “Edit” to access Parametric EQ, Frequency, Q/Bandwidth, Gain, Crossover, Tilt Control, Delay, and Limiter settings.

PARAMETRIC EQUALIZATION

Configuration for the ten bands of parametric equalization is available. Equalization filters may boost or cut the desired frequency with adjustable bandwidth filters. Each one can be individually turned on or off as required by selecting the EQ button and then toggling the on/off switch.

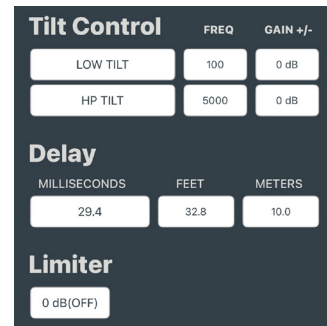
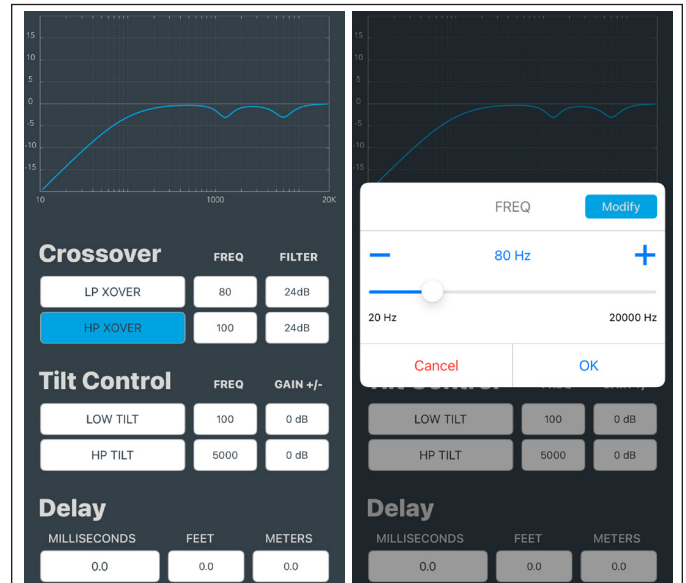

Figure 24: Crossover, Delay App Screens

CROSSOVER | DELAYS

When the amplifier is used to provide high and low passed signals to drive woofers and tweeters separately, crossover and tilt control can be adjusted. Delay compensation can be applied in time or distance units of measurement as required (up to 29.4ms, 32.8 feet, or 10 meters).

SONARC APP GUIDELINES		
APP SETTING	SELECTIONS	DETAILS
GENERAL		
Name	Text Field	Enter desired name for amplifier; appears in list of available amps in homepage.
Auto-ON Mode	Auto Sense or Always On	Auto Sense activates/wakes the amp from sleep mode automatically when incoming audio is detected. When Always On is selected, the amp will not go into sleep mode.
Sleep Mode	1-180 Minutes	Sleep mode puts the amp into power saving mode. Use this setting to choose the duration of time before the amp goes into sleep mode after no incoming audio is detected. Adjust the value by tapping "+" or "-" in the pop up, or press and adjust the slider to the left and right. Select "OK" to confirm and save choice.
LED Timeout	10 Sec or Always On	By default, the amp indicator LED will remain illuminated at all times. If this setting is changed to "10 Sec", the LED will turn off after 10 sec and will not reilluminate until the amp receives a new signal or setting adjustment (ie. switchover behavior is changed).
BLE Radio Setup	Always On, 2 Min Time Out, or Off	To restrict remote access to the amp's settings, the BLE radio can be disabled. A 2-minute timeout can be set to allow adjustments for a short period after the amp is turned on, or it can be set to Off to disable immediately. Once disabled, the amp will no longer be visible in the app. To restore discoverability, press the setup button on the amplifier. The BLE radio setting will default to "Always On" following this action.
LED Level	Low, Middle, or High	Defines indicator LED brightness that illuminates on the connector panel of the amp.
Restart	Cancel or Restart	Would you like to restart the amp? Make selection in pop up window.
VOLUME		
Volume	0-30	Master volume; can simultaneously control the volume of all input sources as well as the volume of the amp and line-out. Adjust the volume by tapping "+" or "-" in the pop up, or press and adjust the slider to the left and right. Select "OK" to confirm and save.
Mute	Off or On	Select "On" to mute all amplifier channels. Select "Off" to return to normal volume output from all channels.
Turn-On Volume	Fixed or Last	Defines the volume condition upon amp startup. Select "Fixed" to define the value for the volume (0-30), or "Last" to keep the volume as it was in the last state before the amp was in sleep mode or standby.
Volume Limit	1-30	Sets the maximum volume control level the amplifier can reach. Adjust the volume limit by tapping "+" or "-" in the pop up, or press and adjust the slider to the left and right. Select "OK" to confirm and save choice.
INPUTS - DIGITAL SOURCE		
Input Trim	-18 dB - 6 dB	By default, the digital source input trim is set to 0.0 dB as it will apply to most use cases. The input trim can be adjusted by 0.5 dB increments if TV output is not sufficient or if the TV volume level needs to be reduced. Adjust the input trim by tapping "+" or "-" in the pop up, or press and adjust the slider to the left and right. Select "OK" to confirm and save.
INPUTS - ANALOG SOURCE		
Input Trim	0 dB - 24 dB	By default, the analog source input trim is set to 0.0 dB as it is optimized for most sources that have 2v maximum output. The input trim can be adjusted by 0.5 dB increments according to the output level of the source device. Adjust the input trim by tapping "+" or "-" in the pop up, or press and adjust the slider to the left and right. Select "OK" to confirm and save. Adjust to +6 dB for sources with 1v output, +12 dB for sources with 500mV output, +18 dB for sources with 250mV output, +24 dB for sources with 125mV output.
Volume Tracking	Off or On	When turned "On", volume tracking lets the analog input track to the master volume. When set to "Fixed", volume will remain at a fixed level. When set to "Off", the volume will not be adjusted in the amp, but instead will need to be adjusted using the analog source.
INPUTS - SOURCE SWITCHING		
Default Source	Analog or Digital	Defines which source input will be primary to activate the amplifier.
Secondary Source	None, Analog, or Digital	Defines which source input will be secondary. In "Mute" and "Duck" modes, a signal on the Secondary Source will override playback of the Default source. Select "None" if no second source is connected.
Switchover Behavior	Mute, Duck, or Mix	Defines how dual input sources behave if there is incoming audio for both inputs at the same time. When "Mute" is selected, the default/primary source will mute when there is incoming audio from the secondary source. When "Duck" is selected, the default source volume will significantly reduce (-20 dB) when there is incoming audio from the secondary source. When "Mix" is selected, the inputs will combine equally.
Switching Hold Time	1-30	Defines the length of time audio will hold when switching sources from one input source to another after audio stops.
LINE OUTPUT		
Volume Tracking	Off or On	With volume tracking set to "On", the line output level will increase and decrease with the volume of the Sonance amp. Volume tracking set to "Off" keeps the output at a consistent level regardless of the Sonance amp volume.

SONARC APP GUIDELINES		
APP SETTING	SELECTIONS	DETAILS
Infrasonic Filter	Off, 20Hz, or 30Hz	The Infrasonic Filter is a high pass filter that prevents extreme low frequencies from damaging the equipment. Use this setting to enable and set the filter frequency.
LPF Frequency	Off, 60Hz, 70Hz, 80Hz, 90Hz, 100Hz, 110Hz, or 120Hz	The Low Pass Frequency can be adjusted to match the rolloff frequency of a connected active subwoofer. See the specifications for the subwoofer and match the rolloff frequency to the LPF frequency in this setting.
Channel Configuration	Stereo or Mono	For standard stereo pair speaker connections to the amp, set channel configuration to "Stereo". When configuring the amp for a single speaker or Power Sharing Mode for a single speaker or subwoofer, set channel configuration to "Mono".
Phase	Normal or Inverted	By default, the line out phase will be set to "Normal". You may choose to invert the line out phase for active subwoofer applications if the subwoofer sounds like it is out of phase in certain room set ups.
Audio Delay	0-30 ms	Audio delay can be adjusted to help correct for audio playback that is not properly synced. This may occur when connecting multiple amplifiers in a daisy chain (line out to new additional amplifier input). Adjust the audio delay in millisecond increments by tapping "+" or "-" in the pop up, or press and adjust the slider to the left and right. Select "OK" to confirm and save choice.
AMP & DSP - AMPLIFIER OUTPUT		
Channel Configuration	Stereo2-CH, Mono-2CH, L Only to L Output, R Only to L Output, Sum Mono to L Output	Use L Output settings to get 250w single channel power from L speaker output into a single 4 ohm load. Connect speakers to L channel only. This setting allows you to control which source channels are routed to the L output.
Phase	Normal or Inverted	By default, the amp output phase will be set to "Normal". You may choose to invert the line out phase to correct speaker polarity or passive subwoofer phase correction.
Amp Output Trim	-6 dB - 0 dB	Set the Amp Output Trim to properly accommodate the amplifier load. In Stereo Configuration, set the trim to 0 dB for 8 ohm; -1.5 dB for 6 ohm; -3 dB for 4 ohm. In Mono configuration, set the trim to 0 dB for all loads.
AMP & DSP - DSP PRESET		
Name	Text Field	Enter desired name for preset. This will be the name of the DSP profile when selected for "Save" and will appear in the list of saved presets on the bottom of the screen.
Load	Must Select a Saved Preset to Import	Select from downloaded DSP Presets in the Saved Preset list at the bottom of the screen before pressing "load". If no saved presets are listed, click the "Download" button to select an EQ profile from the library.
Save	Cancel or Sure	Save the current DSP settings for future recall? If adjustments are made to an imported profile, the new DSP/EQ profile/preset can be saved into the Saved Preset list.
Edit	Loads an Editing Menu	Edit and apply Parametric EQ, Frequency, Q/Bandwidth, Gain, Crossover, Tilt Control, Delay, and Limiter settings to an already loaded DSP Preset.
Saved Presets	Download	Browse the Sonance custom DSP preset library designed specifically to optimize a range of Sonance speakers and subwoofers. Once downloaded, use the import function to load the custom preset from the menu below.
PROFILE BACKUP		
Backup Profile	Text Field: enter a file name for the profile, save	Save a backup profile to restore all amplifier settings, IR codes, and DSP to a previous configuration for easy recall. Saved profiles are accessible after factory reset.
Restore Profile	Load	Restore the currently selected profile to apply all saved amp settings? Select "Cancel" or "Sure". A profile from the list of Available Backup Files must be selected to initiate. If no profiles are listed, a backup profile must be created. See "Backup Profile" above.
Share Profile	-	Send an amplifier profile to another device via email, AirDrop, etc.
Available Backup Files	-	A list of all saved backup profiles will appear here. If no profiles are listed, a backup profile must be created. See "Backup Profile" above. Backup files are also saved to the device's FILES folder as a .bin file.
PROFILE BACKUP - RESET		
Reset All Settings	Cancel or Sure	It is recommended to save a backup profile before reset. Would you like to reset all amp settings to factory defaults? Select "Cancel" or "Sure". CAUTION: This function will erase all settings and return the amplifier to its factory default!
STATUS		
-	Normal, Too Hot, or System Protection	Displays current amp status.
IR LEARNING		
-	-	Plug the included IR receiver into the amp to configure an IR remote to control the amp. Press Learn, and choose the remote button you wish to program to control the selected function. NOTE: When IR 3.5mm cable is inserted into the IR port, all digital communications will be disabled (ie. CEC, eARC, S/PDIF commands such as ON/OFF, Volume UP/DOWN).
Power On	-	Select "Learn" to initiate signal for IR learning
Power Off	-	Select "Learn" to initiate signal for IR learning

SONARC APP GUIDELINES		
APP SETTING	SELECTIONS	DETAILS
Volume Up +1	-	Select "Learn" to initiate signal for IR learning
Volume Down -1	-	Select "Learn" to initiate signal for IR learning
Volume Up +3	-	Select "Learn" to initiate signal for IR learning
Volume Down -3	-	Select "Learn" to initiate signal for IR learning
Mute On	-	Select "Learn" to initiate signal for IR learning
Mute Off	-	Select "Learn" to initiate signal for IR learning
Mute Toggle	-	Select "Learn" to initiate signal for IR learning
UPDATES		
Firmware	-	-
Installed Version	-	Displays the firmware version currently installed.
Latest Version	-	Displays the firmware version currently available.
Update	Local or Internet	Proceed with firmware update? Select "Local" or "Internet", then select "Update Now" or "Cancel" at any time to terminate update process.

UA 2-125 | UA 2-125 ARC AMPLIFIER POWER REQUIREMENTS:

MODEL	INPUT VOLTAGE	OUTPUT POWER (SINEWAVE)	AC POWER DRAW	15 AMP BREAKER QTY OF AMPLIFIERS	20 AMP BREAKER QTY OF AMPLIFIERS
UA 2-125 North America SKU: 93550 International SKU: 93551 UA 2-125 ARC North America SKU: 93548 International SKU: 93549	100-240V AC	Full Power All Channels @8 ohms	300W	8	10
		Full Power All Channels @4 ohms	300W		
		1/4 Power All Channels @8 ohms	80W		
		1/4 Power All Channels @4 ohms	80W		
		@ Idle	8W		
		Sleep Mode	<0.5W		

UA 2-125 | UA 2-125 ARC AMPLIFIER SPECIFICATIONS

Number of Channels	2 (1 stereo pair)
Power Output - 8 ohms x2 (Stereo)	125W per channel
Power Output - 4 ohms x2 (Stereo)	125W per channel
Power Output - 4 ohms x1 (Single Channel)	250W
Frequency Response	20Hz - 20kHz , +/- 0.5dB
Total Harmonic Distortion	<0.1% (1kHz, 100W, 4Ω or 8Ω)
Signal to Noise Ratio	>100dB (20-20kHz, A-weighted)
Analog Input Sensitivity	170 mVrms for full output power, +24dB input trim 2 Vrms for full output power, 0dB input trim
Analog Input Impedance	32 kohms
Analog RCA Output Source Resistance	600 ohms
Analog Maximum Source Input Voltage	2 Vrms
COAX Digital Input	S/PDIF format, 2ch PCM
Optical TOSLINK Digital Input	S/PDIF format, 2ch PCM
HDMI Digital Input	HDMI ARC, eARC, and CEC capable, 2ch PCM,
Power Consumption	
8 or 4 ohms (sinewave, full power, 125W x2)	300 Watts
8 or 4 ohms (sinewave, 1/4 power, 31W x2)	80 Watts
@idle (active, no output)	8 Watts
@idle (amp output off)	3 Watts
@standby	<0.5 Watt
@sleep mode	<0.5 Watt
Heat Output	
@8 ohms (sinewave, full power)	171 BTU/h (both channels driven)
@4 ohms (sinewave, full power)	171 BTU/h (both channels driven)
@8 ohms (sinewave, 1/4 power)	62 BTU/h (both channels driven)
@4 ohms (sinewave, 1/4 power)	62 BTU/h (both channels driven)
AC Voltage	100-240Vac 50/60Hz
Mounting Options	Seismic tether (hole in chassis); slide-in mounting bracket; 20mm series T-slots
Dimensions (WxHxD)	8.2" x 5.32" x 1.78" (208mm x 135mm x 45mm)
Dimensions (LxWxD) w/ Mounting Brackets	8.86" x 5.32" x 1.78" (225mm x 135mm x 45mm)
UA 2-125 Shipping Weight	5lbs 4oz (2.38Kg)
UA 2-125 ARC Shipping Weight	5lbs 6oz (2.44Kg)

TROUBLESHOOTING

NO POWER

Audio Connector Panel status LED does not illuminate when AC cord is plugged into an outlet and the amp is switched on.

CAUSE: AC cable is improperly seated either at the back of the amp or at the AC outlet.

SOLUTION: Verify that both ends of the power cable are securely seated.

CAUSE: There is no AC current at the outlet.

SOLUTION: Securely insert the AC cord into another known working AC outlet.

CAUSE: T Amp is actually powered but is in standby mode. There is no active signal and status LED is dark because it is set to time out.

SOLUTION: Send an audio signal to the amplifier, or use the General page of the SonARC app to change the LED Timeout to Always On.

NO AUDIO

Status indicator illuminated Green but no audio from speakers.

CAUSE: Current selected source is not sending an audio signal into the amp.

SOLUTION: Verify that the source is powered on, operating and not in a muted or paused state.

CAUSE: Audio interconnect cables are not pushed-in securely at the source, at the preamp and/or at the amp's input connectors.

SOLUTION: With the amp powered off, carefully reinsert each of the RCA connections at the source, and preamp/zone controller. Ensure RCA connectors are plugged into the amplifier's INPUT terminals, not the OUTPUT terminals.

CAUSE: The line level interconnect cables are defective.

SOLUTION: Substitute another interconnect cable for the source to preamp.

CAUSE: The speaker wires at either the output of the amp or at the speaker location are not securely connected.

SOLUTION: Reattach the speaker wires on the 4-terminal speaker block connectors. Verify amplifier output with a short piece of speaker wire and a known good speaker.

CAUSE: Input / Source settings are mis-configured and the input signal is being ignored.

SOLUTION: Use the Input page of the SonARC app to properly configure the Input settings for the desired source. Make sure the source is set up as either a Default source or Secondary source. If set as the Default source, make sure there is not a signal on the Secondary source that is causing the Default source to be muted or ducked.

CHANNEL OUT

One channel of the amp does not have output.

CAUSE: Line-level interconnect cable from the source to the affected amp channel is loose, disconnected or faulty.

SOLUTION: Verify that the interconnect cables are properly seated at both the amp end inputs and source end outputs. Disconnect both interconnects on the amp end (1L and 1R input connections on the amp). Connect the functioning channel's cable from the source to the non-functioning channel's input jack on the amp (for example: if 1L is faulty, connect 1R's cable to the 1L input jack and test). Test playback to see if the speaker connected to the non-functioning channel works. If the affected channel is now working, the problem could be with that channel at the source or with the interconnect cable for the non-functioning channel. Replace the affected channel's interconnect cable and retest. Test source on another audio system to confirm channel outputs are functioning. Check coax, Toslink and HDMI connections as appropriate to model.

CAUSE: Speaker wire leading out to the channel is loose, disconnected or faulty.

SOLUTION: Verify proper connection of the speaker wire at amp end and speaker end. If the channel is still inoperative, disconnect the speaker wire from the non-functioning channel at both the amp end and speaker end. Connect a new, test speaker wire from the affected amp channel output to the speaker or to a new, test speaker. If the affected channel is now working, the problem must be the speaker wire; replace with a new speaker wire. If the affected channel is still not working, the affected channel in the amp could be defective; contact Sonance Technical Support for next steps.

PROTECT MODE

Status Indicator LED is flashing RED.

CAUSE: The amplifier is in an over-temperature condition due to overload.

SOLUTION: Allow the amplifier to be sufficiently cooled until the Status LED returns to ORANGE, BLUE, GREEN, or WHITE. Ensure that the amplifier is placed in a location for proper ventilation.

CAUSE: The amplifier receiving an over-current from short-circuited output wiring or too low output impedance load being driven.

SOLUTION: Remedy the shorted output. Check all wiring and speakers to ensure no shorts are present. Disconnect from AC Power before attempting to fix and reconnect the wiring.

CAUSE: The amplifier Output Channel Configuration is set up for Power Sharing Mode in the Amplifier & DSP page of the settings.

SOLUTION: Use the Amp & DSP page of the SonARC app to change the Channel Configuration to either Stereo 2-ch or Mono 2-ch.

LIMITED TWO (2) YEAR WARRANTY

Sonance warrants to the first end-user purchaser that this Sonance-brand product (Sonance UA 2-125 or UA 2-125 ARC), when purchased from an authorized Sonance Dealer/Distributor, will be free from defective workmanship and materials for the period stated below. Sonance will at its option and expense during the warranty period, either repair the defect or replace the Product with a new or remanufactured Product or a reasonable equivalent.

EXCLUSIONS: TO THE EXTENT PERMITTED BY LAW, THE WARRANTY SET FORTH ABOVE IS IN LIEU OF, AND EXCLUSIVE OF, ALL OTHER WARRANTIES, EXPRESS OR IMPLIED, AND IS THE SOLE AND EXCLUSIVE WARRANTY PROVIDED BY SONANCE. ALL OTHER EXPRESS AND IMPLIED WARRANTIES, INCLUDING THE IMPLIED WARRANTIES OF MERCHANTABILITY, IMPLIED WARRANTY OF FITNESS FOR USE, AND IMPLIED WARRANTY OF FITNESS FOR A PARTICULAR PURPOSE ARE SPECIFICALLY EXCLUDED.

No one is authorized to make or modify any warranties on behalf of Sonance. The warranty stated above is the sole and exclusive remedy and Sonance's performance shall constitute full and final satisfaction of all obligations, liabilities and claims with respect to the Product.

IN ANY EVENT, SONANCE SHALL NOT BE LIABLE FOR CONSEQUENTIAL, INCIDENTAL, ECONOMIC, PROPERTY, BODILY INJURY, OR PERSONAL INJURY DAMAGES ARISING FROM THE PRODUCT, ANY BREACH OF THIS WARRANTY OR OTHERWISE.

This warranty statement gives you specific legal rights, and you may have other rights which vary from state to state. Some states do not allow the exclusion of implied warranties or limitations of remedies, so the above exclusions and limitations may not apply. If your state does not allow disclaimer of implied warranties, the duration of such implied warranties is limited to period of Sonance's express warranty. Your Product Model and Description: Sonance UA 2-125 or UA 2-125 ARC Amplifier. Warranty Period for this Product: Two (2) years from the date on the original sales receipt or invoice or other satisfactory proof of purchase.

Additional Limitations and Exclusions from Warranty Coverage: The warranty described above is non-transferable, applies only to the initial installation of the Product, does not include installation of any repaired or replaced Product, does not include damage to allied or associated equipment which may result for any reason from use with this Product, and does not include labor or parts caused by accident, disaster, negligence, improper installation, misuse (e.g., overdriving the amplifier or speaker, excessive heat, cold or humidity), or from service or repair which has not been authorized by Sonance.

Obtaining Authorized Service: To qualify for the warranty, you must contact your authorized Sonance Dealer/Installer or call Sonance Customer Service at (949) 492-7777 within the warranty period, must obtain a return merchandise number (RMA), and must deliver the Product to Sonance shipping prepaid during the warranty period, together with the original sales receipt, or invoice or other satisfactory proof of purchase.

Warranty Process: Please follow the troubleshooting instructions in this manual or work with your Sonance dealer to determine the exact nature of the fault. Sonance provides a 2-Year Limited Warranty to the original owner with proof of purchase from an authorized Sonance dealer. The warranty does not cover shipping charges back to Sonance or the use of the product in an environment or application not approved by Sonance.

In order to initiate a warranty claim:

1. Contact Sonance Technical Support with a description of the fault, the amplifier's serial number and the date of purchase from an authorized Sonance dealer at: technicalsupport@sonance.com
2. Sonance Technical Support will follow-up and may request additional troubleshooting.
3. Once a determination has been made on the fault, Sonance Customer Service will follow-up by email. Please have a scanned copy of your Sonance UA 2-125 or UA 2-125 ARC Amplifier sales invoice ready to send upon request to document the amplifier's warranty status.
4. Sonance Customer Service will provide an RMA number to be included on the shipping label of the packaging. Please send the amplifier back in its original factory carton, which has been specifically designed to protect the amplifier during transit. Write the RMA # on the shipping label, not directly on the product carton.

Contact us at: <https://www.sonance.com/company/contact>