

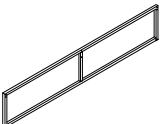

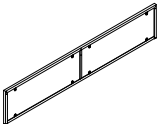

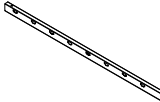

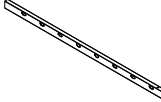



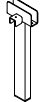
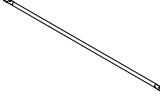

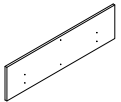
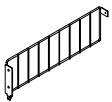
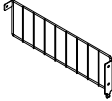
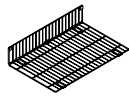







ASSEMBLY INSTRUCTION

PLATFORM FULL/QUEEN BED WITH 4PCS STORAGE DRAWERS

A Headboard 1PC 	B Footboard 1PC 	C Front Rail Section 2PCS 	D Rear Rail Section 2PCS 
E Center Support Bar 1PC 	F Rail Support Leg 2PCS 	G Slat 16PCS 	H Slat Connector 32PCS 
I Drawer Front Panel 4PCS 	J Drawer Left Side Frame 4PCS 	K Drawer Right Side Frame 4PCS 	L Drawer Bottom Frame 4PCS 
M Caster 4PCS 	N Drawer Panel Connector 4PCS 	O Drawer Frame Connector 4PCS 	P Center Rail 4PCS 
Q Support Leg 16PCS 	R Bolt 1/4" x 13mm 4PCS 	S Bolt 1/4" x 32mm 8PCS 	T Bolt 1/4" x 7mm 2PCS 
U Bolt 1/4" x 19mm 3PCS 	V Bolt 1/4" x 45mm 28PCS 	W Bolt 5/16" x 48mm 2PCS 	X Bolt 1/4" x 19mm 24PCS 
Y Nut 1/4" 4PCS 	Z Washer 1/4" 8PCS 	AA L-Allen Key 4mm 4PCS 	AB Wrench 1/4" x 5/16" 2PCS 
2PCS	4PCS	1PC	1PC

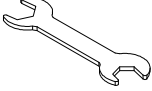
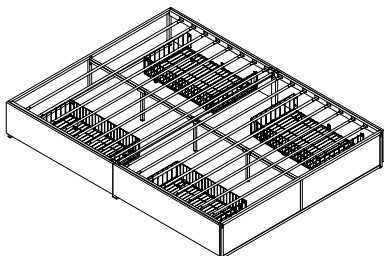

This page lists all the contents included in the box. Please take the time to identify the hardware as well as the individual components to this product. As you unpack and prepare for assembly, place the contents on a carpeted or padded area to protect them from damage.

1

Attach Rail Support Leg (F) to Front & Rear Rail Section (C & D) using Bolt (W) with L-Allen Key (AA).

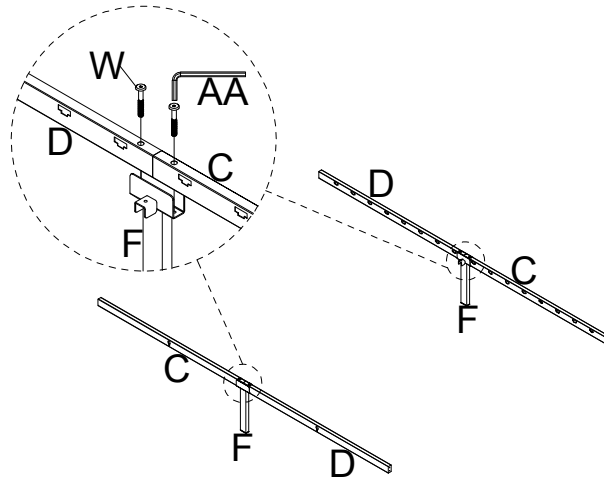

2

Attach Center Support Bar (E) to Rail Support Leg (F) using Bolt (X) with L-Allen Key (AA).

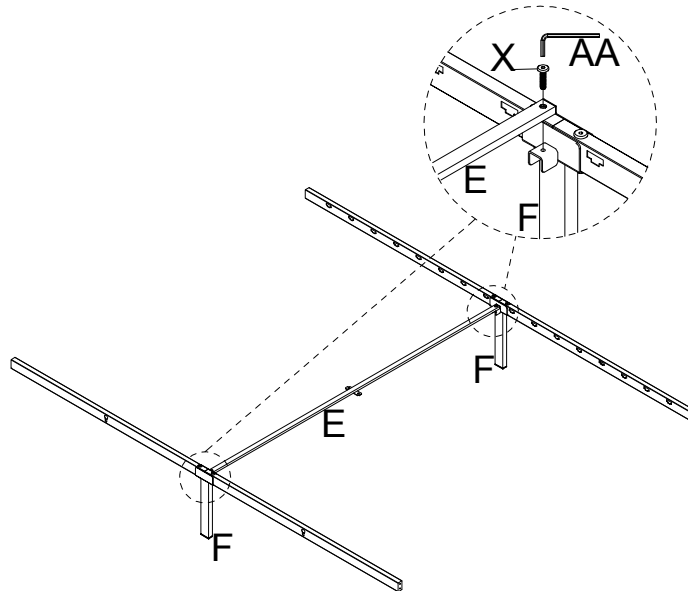

3

Attach Headboard (A) and Footboard (B) to Front & Rear Rail Section (C & D) using Bolt (V) with L-Allen Key (AA).

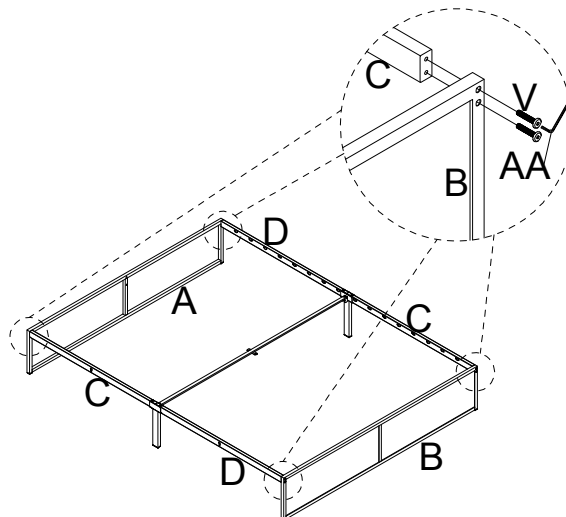

4

Attach Support Leg (Q) to Center Rail (P) using Bolt (R) with L-Allen Key (AA).

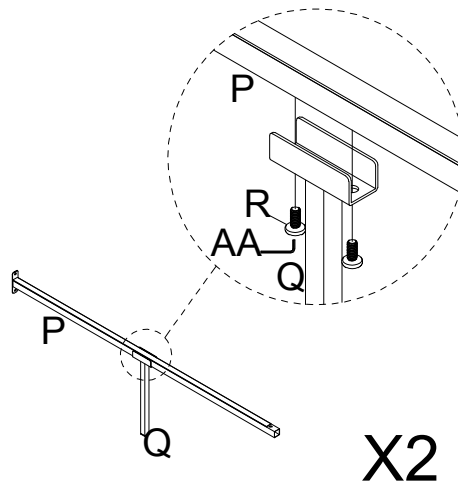

5

Attach Center Rail (P) to Support Leg (Q). Then attach the assembled part to Center Support Bar (E) using Bolt (S) and Nut (Y) with L-Allen Key (AA) and Wrench (AB).

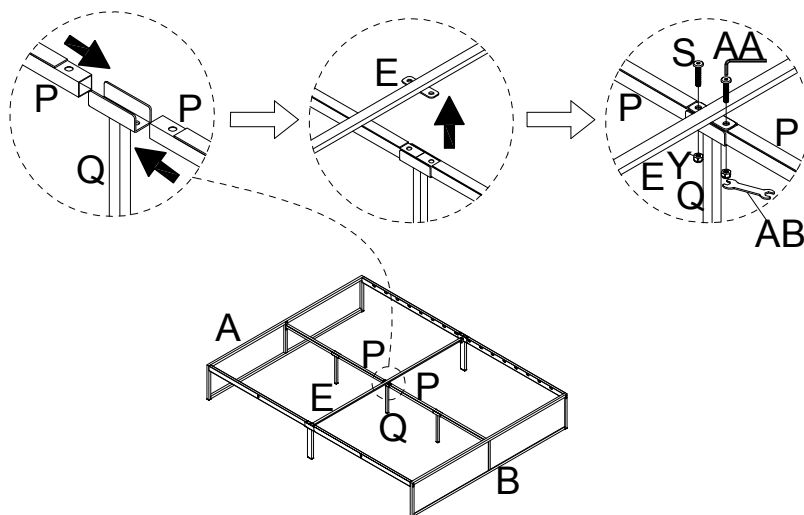

6

Attach Center Rail (P) to Headboard (A) and Footboard (B) using Bolt (R) with L-Allen Key (AA).

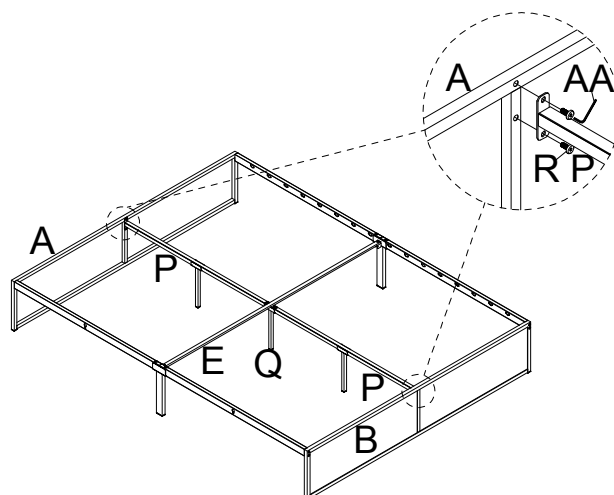

7 Insert Slat (G) into Front & Rear Rail Section (C & D) as shown. Then lock Slat Connector (H) to fix Slat (G).

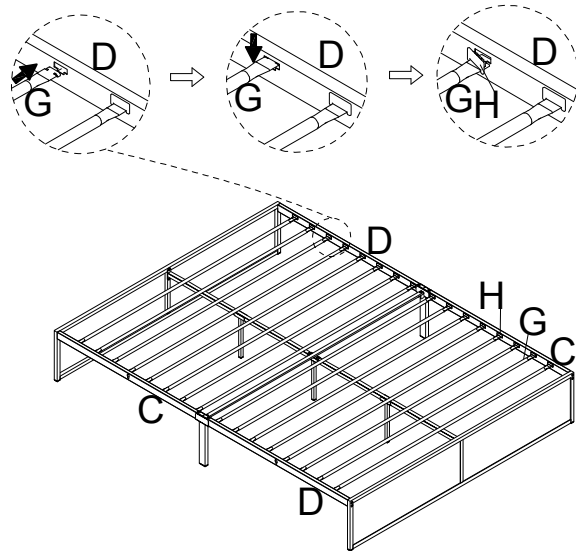

8 Hook Drawer Left & Right Side Frame (J & K) to Drawer Bottom Frame (L) and assemble them using Bolt (T) with L-Allen Key (AA). Then lock Drawer Frame Connector (O) as shown.

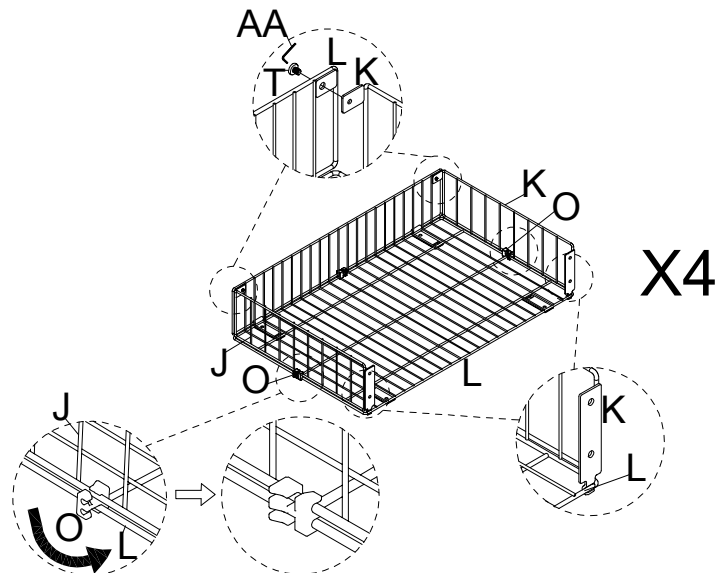

9 Insert Caster (M) into the Slot of Drawer Bottom Frame (L) and assemble them using Bolt (T) with L-Allen Key (AA).

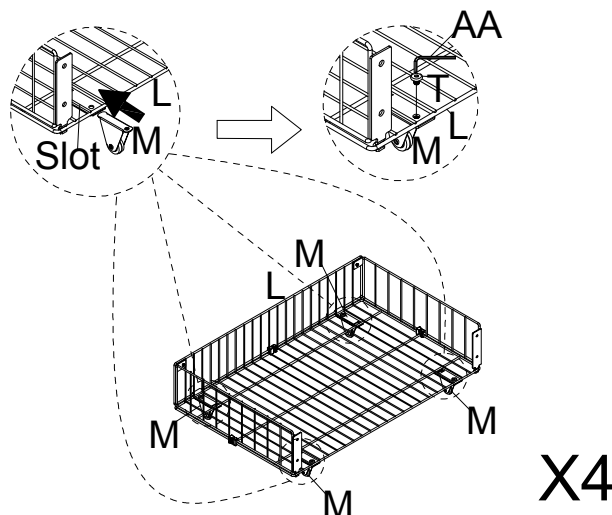

10 Attach Drawer Front Panel (I) to Drawer Left & Right Side Frame (J & K) using Bolt (R) with L-Allen Key (AA). Then attach Drawer Panel Connector (N) to Drawer Bottom Frame (L) and Drawer Front Panel (I) using Bolt (R) with L-Allen Key (AA).

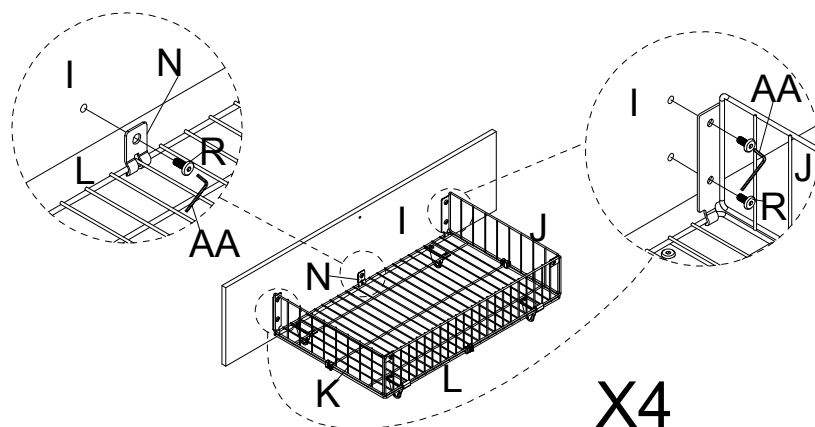

11 Insert Bolt (U) and Washer (Z) into Drawer Front Panel (I) and tighten with L-Allen Key (AA).

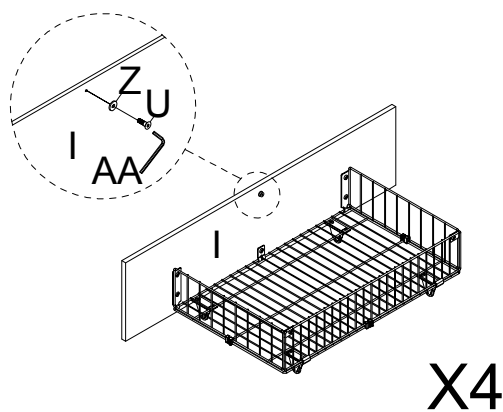

12 Align the drawer and place it under the bed. Lift the drawer slightly and insert the Pin into the Slot to lock the drawer.

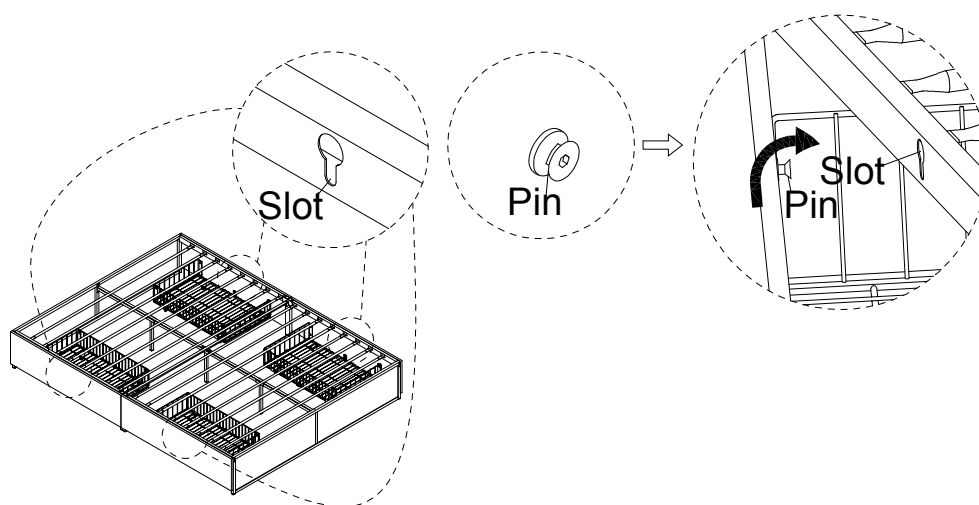

Cleaning & Care

Treat surfaces with care. Surfaces are resistant to scratches but are not scratch resistant. Clean surfaces with a dry or damp soft cloth. Do not use abrasive cleaners. Hardware may loosen over time. Periodically check that all connections are tight.