



# BE9ACP.X USER MANUAL

APPLE CARPLAY® & ANDROID AUTO™ (WIRED)

BLUETOOTH® | 340 WATTS | MP3-COMPATIBLE

DIGITAL MEDIA AM/FM RECEIVER

FEATURING 9" (229 mm) CAPACITIVE TOUCHSCREEN

AND MULTICOLOR ILLUMINATION OPTIONS





*Thank you for choosing BOSS Audio Systems!*

Sign up for BOSS Audio Systems News and Promos by visiting us on the web at [www.bossaudio.com](http://www.bossaudio.com).

Be part of our community! Join us by signing up on the web at [www.bossinsiders.com](http://www.bossinsiders.com)

<b><i>IMPORTANT! Complete the information below and keep for your records.</i></b>	
<b>Model</b>	
<b>Serial Number</b>	
<b>Date of Purchase</b>	
<b><i>Note: Serial number is located on the packaging and the top of the product chassis.</i></b>	

# Table of Contents

## Important Information 4

About this Manual.....	4
Operation Warnings.....	4
Installation Warnings.....	4
Screen Care.....	5
Notice.....	5

## Basic Operation 6

What Comes in the Box.....	6
Control Panel.....	7
First Time Setup.....	8
Home Menu Description.....	9

## FM/AM Radio 10

Radio Home Screen.....	10
Tune to a Radio Station.....	10
Auto Store Radio Stations.....	10
Preset a Radio Station.....	10
Search via Frequency Input.....	10
FM Local and Distant.....	10
FM Stereo and Mono.....	10

## SiriusXM® Radio 11

Preparation.....	11
SiriusXM Home Screen.....	11
Select a Channel.....	12
Preset a Channel.....	12
Artist & Song Alerts.....	12
Set Artist & Song Alerts.....	12
Parental Control.....	13

## Apple CarPlay 14

Apple CarPlay Introduction.....	14
Connect your iPhone.....	14
Arrange your CarPlay Apps.....	15
Disable CarPlay Apps.....	15

## Android Auto 16

Android Auto Introduction.....	16
Connect your Android Device.....	16

## Bluetooth 17

First Time Connection.....	17
Audio Streaming.....	17

Make a Call.....	18
Operation During a Call.....	18
Sync Phonebook and History.....	18
Search a Contact.....	18
Browse Call History.....	18
View Connection Status.....	18
Voice Assistant (Push-To-Talk).....	18

## USB 19

USB Playback.....	19
Audio/Video/Photo Play Switching.....	19
Audio Playback.....	19
Video Playback.....	19
Photo Playback.....	19

## Other External Devices 20

Audio/Video Input.....	20
Playback.....	20
Audio Input.....	20
Video Input.....	20
Manual Camera Trigger.....	20
Automatic Camera Trigger.....	20

# Table of Contents

## Set Sound Effects 21

Sound Mode and Equalizer Setting .....	21
Volume Balance Setting .....	21
Crossover Frequency Setting .....	21
Time Alignment Setting .....	21

## General Settings 22

System Tone and Shutdown Delay .....	22
Set Date and Time Manually .....	22
Set Date and Time Automatically .....	22
Language Setting .....	22
Steering Wheel Control Retention .....	22

## Audio Settings 23

Loudness and Sound Effect Setting .....	23
Startup Volume Setting .....	23
Initial Volume Setting for Other Sources .....	23
Customization of a Source Volume .....	23

## Display Settings 24

Wallpaper Setting .....	24
Screen Setting .....	24
Automatic Dimming Control .....	24
Panel Button Light Setting .....	24

Underglow Brightness Control .....	24
------------------------------------	----

## Bluetooth Settings 24

## Radio Settings 25

Radio Region Selecting .....	25
RDS/RBDS Activation .....	25
RDS/RBDS Information Display .....	25
RDS/RBDS Traffic Announcement .....	25
RDS/RBDS Alternative Frequency .....	25

## Camera Settings 25

Camera Trigger Control .....	25
Parking Assist Guidelines Setting .....	26

## System Information 26

Firmware Version Information .....	26
Firmware Update .....	26
Resetting the Unit .....	26

## Unit Installation 27

Single DIN Opening Installation .....	27
Double DIN Opening Installation .....	28
Display Assembly .....	28

Display Positioning .....	29
---------------------------	----

Installation Dimensions .....	30
-------------------------------	----

## Connections 31

Power and SWC Input Wiring .....	31
Speaker Wiring .....	32
Parking Brake Wiring .....	33
AV/Radio .....	34
SiriusXM/Mic/Camera/CarPlay/Android Auto ..	35
Hands-Free Mic Installation .....	36

## Troubleshooting 37

## Specifications 39

# Important Information

## About this Manual

To understand how to properly use your new BOSS Audio Systems product, it is recommended to read this user manual in its entirety, and keep it in a safe place for future reference.

This manual uses illustrations to show you how to use this product safely and alert you to potential dangers resulting from improper connections and operation. It is important to fully understand the meaning of each one of these illustrations in order to use this manual and system properly.

### WARNING

The **WARNING** illustration denotes very important instructions. Failure to follow them can result in damage to equipment, serious injury or death.

### CAUTION

The **CAUTION** illustration denotes important instructions. Failure to follow them can result in injury or material property damage.

### IMPORTANT NOTE

The **IMPORTANT NOTE** illustration denotes important instructions for product features and limitations. Failure to follow them will result in product misuse and/or unexpected behavior.



The **PARKING BRAKE** illustration denotes features that can only be used with vehicle not in motion and parking brake engaged. Failure to follow them will result in product misuse and/or unexpected behavior.

## Operation Warnings

### WARNING

#### **OPERATION OF THIS PRODUCT WHILE DRIVING IS DANGEROUS.**

Users should come to a complete stop and in a safe location before using any feature that requires extended periods of time.

#### **PAY ATTENTION TO ROAD CONDITIONS.**

Avoid operating product under dangerous road conditions and abide by regulations over information contained on the map display. Follow traffic restrictions and circumstances while driving.

Familiarize yourself with your local and state laws regarding mobile devices. Certain functions of the mobile phones might be prohibited and or illegal while driving in your location.

#### **OPERATE AT SAFE VOLUME LEVELS.**

Excessive volume levels may obstruct sounds such as emergency vehicle sirens or road warning signals; can be dangerous and may result in an accident. Listening at high volume levels can also cause hearing damage.

#### **DO NOT WATCH VIDEO WHILE DRIVING.**

Watching video content may distract the driver from looking ahead of the vehicle and can potentially cause an accident.

## Installation Warnings

#### **CERTIFIED PROFESSIONAL INSTALLATION.**

Installation and service repair of this product by anyone without professional training and experience in consumer electronics and mobile vehicle accessories may be dangerous and result in electric shock, injury or other hazards.

# Important Information

## DISCONNECT BATTERY.

To avoid potential shorts in the electrical system, be sure to disconnect the **NEGATIVE (-)** terminal cable before beginning this product installation. Failure to do so may result in electric shock, fire, damage to product and/or property damage.

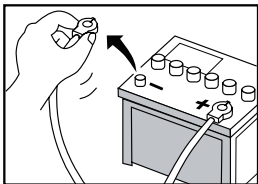

## DO NOT DISASSEMBLE OR ALTER PRODUCT.

Disassembly of product may result in an accident, fire or electric shock.

## REPLACE FUSE WITH THE CORRECT RATING.

Failure to do so may result in fire or property damage.

## PARKING BRAKE INSTALLATION WIRING.

Installing this product incorrectly may enable the user to watch video while driving. This may cause distraction, preventing the driver to focus on the road and potentially cause an accident. The driver and passengers can be severely injured.



## Screen Care

### USE

This head unit utilizes a Capacitive Touchscreen, the same type that is used on high-end mobile devices. It should be used for and cared for like that type of device. As with all capacitive type technology, if your fingers are wet or sweaty, it will not function properly.

Do not allow any sharp objects to come in contact with the screen.

### CLEANING

To clean the screen, use a dry or slightly damp micro fiber type cloth to clean. Do not use ammonia, window cleaner, or any other type of household chemicals to clean the screen. Abrasives should never be used.

Best to clean the screen when the unit is powered off, cool and not in direct sunlight.

## Notice



Apple CarPlay is a trademark of Apple Inc.

iPhone® is a trademark of Apple Inc., registered in the U.S. and other countries.

Use of the Apple CarPlay logo means that this user interface meets Apple performance standards.

Apple is not responsible for the operation of this device or its compliance with safety and regulatory standards.



Android Auto is a trademark of Google LLC.



SiriusXM and all related marks and logos are trademarks of Sirius XM Radio, Inc. All rights reserved.



The Bluetooth® word mark and logos are registered trademarks owned by Bluetooth SIG, Inc. and any use of such marks by BOSS Audio Systems is under license. Other trademarks and trade names are those of their respective owners.

# Basic Operation

## What Comes in the Box

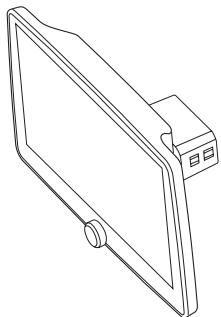

Display

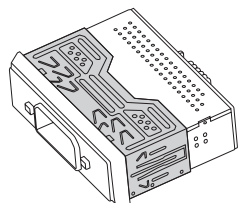

Main Unit with  
Removable Mounting Cage

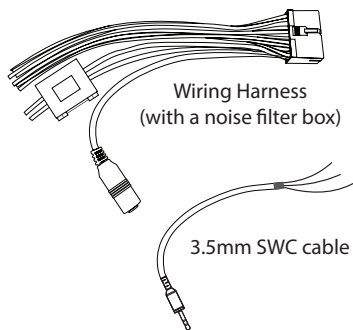

Wiring Harness  
(with a noise filter box)

3.5mm SWC cable

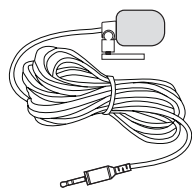

Microphone with 3.5mm Plug  
and Sticky Base

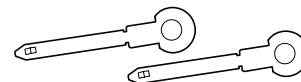

2x Release Keys

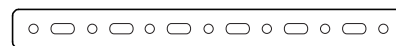

1x Mounting Strap



1x Hex Bolt



1x Hex Nut



2x Plain Washers



1x Tapping Screw  
(M5 x 18mm)



1x Spring Washer



1x Rubber Grommet

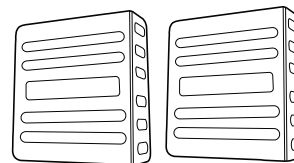

2x Mounting L-Brackets



8x Bolts (M5 x 6mm)

# Basic Operation

## Control Panel

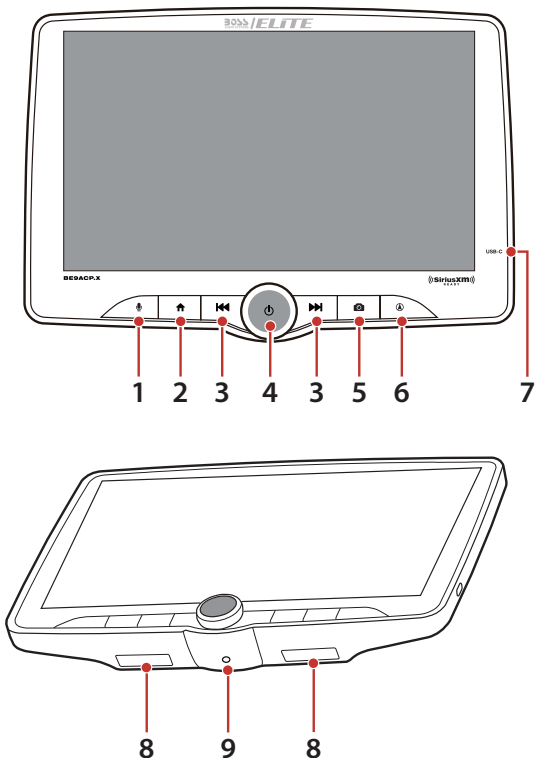

### 1 (Voice assistant/Push-To-Talk)

Press to activate voice assistant.

Enable Apple CarPlay, Android Auto or Bluetooth connection to use voice assistant.

### 2 (Home)

- Press to switch between the home menu and the last selected source.
- When powered on, press and hold to turn the screen off.

### 3 (Next/Previous)

- During music playback, press to skip to next/previous track; press and hold to enable fast forward or backward.
- In FM/AM source, press to tune to a radio station.

### 4 (Power/Volume)

- Press to power on the unit.
- Press and hold to power off the unit.
- Rotate to adjust volume.
- When powered on, press to mute or restore the volume.

### 5 (Camera)

Quick access to camera view.

### 6 (Navigation)

Quick access to navigation app.

Enable Apple CarPlay or Android Auto to use navigation.

### 7 (USB-C port (1.5A charging port))

Audio, video or picture input from a USB flash drive.

If needed, use a USB-C adapter (not included) to fit your USB flash drive into the USB-C port.

### 8 Underglow lights

Sync and match button illumination.

### 9 Reset button

Use a needle or pin to press the button. Reset the unit if the unit fails to function normally.

### TIP:

When the unit is powered off, touch the screen to turn on or off time/date display.

# Basic Operation

## First Time Setup

When you turn on the unit for the first time or reset the unit, the initial setup page will appear.

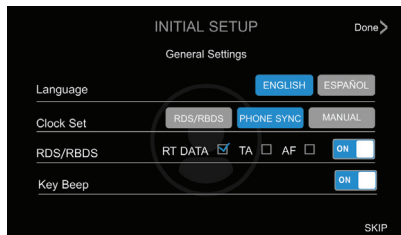

### Set Language

**[Language]:** Select English or Español as a display language for menu.

You can set language later. From the home menu, select **[SETTINGS]** > **[General]** > **[Language]**.

### Set Clock

**[RDS/RBDS]:** Automatically set date and time from RDS/RBDS broadcast.

**[PHONE SYNC]:** Automatically set date and time from Apple CarPlay.

**[MANUAL]:** Set date and time manually.

### Set date and time manually

Select **[MANUAL]** to access time, date and time zone settings.

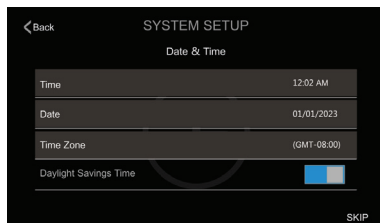

**[Time]:** Access time setting screen. Swipe up and down to set hours, minutes, and AM/PM or 24 hour format respectively.

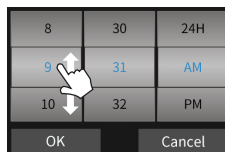

**[Date]:** Access date setting screen. Swipe up and down to set year, month, and day respectively.

**[Time Zone]:** Select a time zone in your current location.

**[Daylight Savings Time]:** Enable to adjust daylight savings time automatically.

You can set date and time later. From the home menu, select **[SETTINGS]** > **[General]** > **[Date & Time]**.

### Set RDS/RBDS Radio

The RDS/RBDS (Radio Broadcast Data System) enables FM stations to send additional information when broadcasting radio.

**[RT DATA]:** Enable/disable display of RDS/RBDS information (i.e. station name, program type or other dynamic/static message).

**[TA]:** Enable/disable traffic announcement (TA).

**[AF]:** Enable/disable switching to alternative frequency (AF) for the same tuning program.

When enabled, the unit will automatically locate the same tuning program on other stations and select the strongest signal of those being broadcast.

**[ON]/[OFF]:** Enable/disable RDS/RBDS features.

You can set RDS/RBDS later. From the home menu, select **[SETTINGS]** > **[Radio]** > **[RDS/RBDS]**.

### Enable/Disable System Tone

**[Key Beep]:** When Off is selected, sound will not be made when touching a button or option on the screen.

# Basic Operation

## Home Menu Description

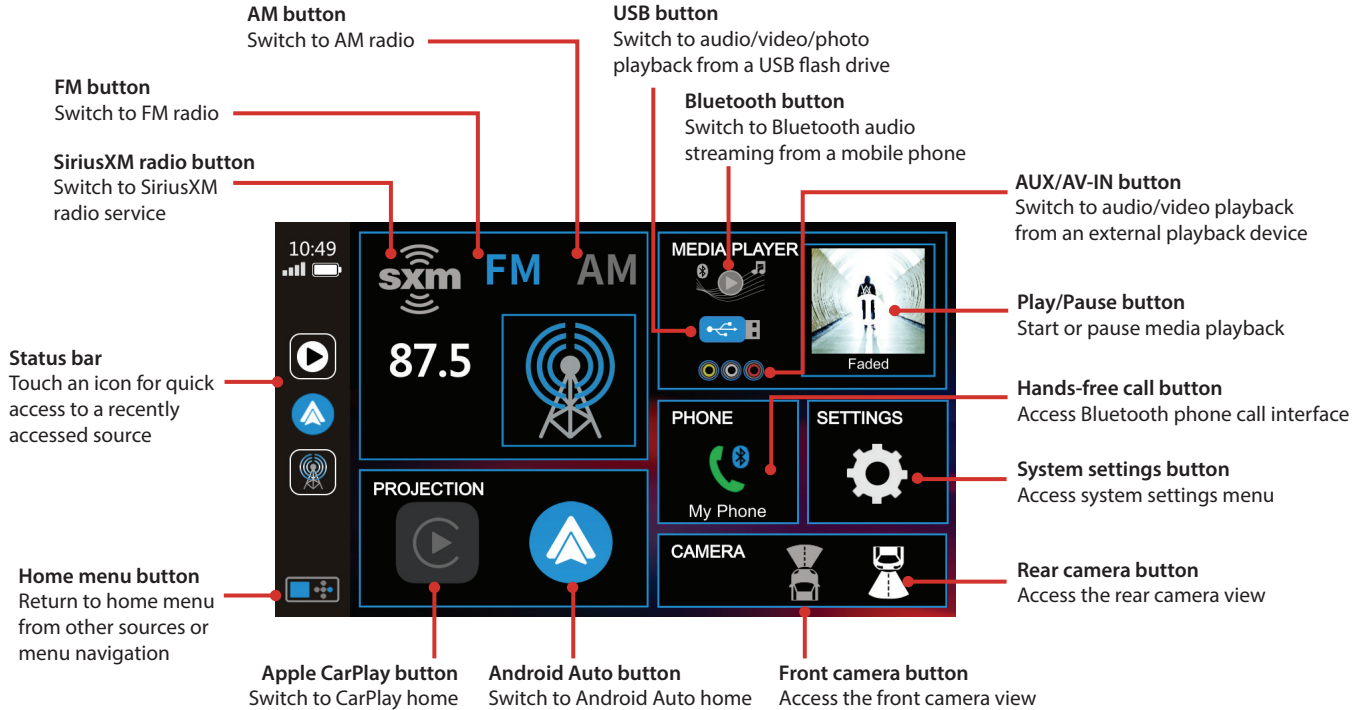

# FM/AM Radio

## Using FM/AM

### Radio Home Screen

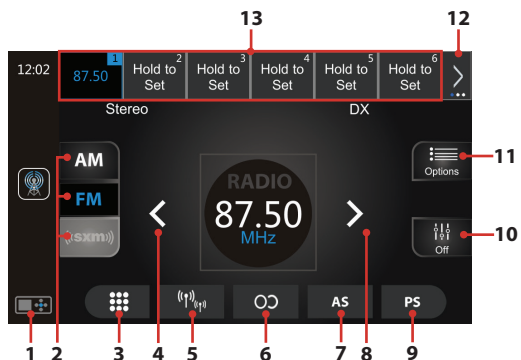

- 1 Return to the home menu.
- 2 Switch between AM, FM and SiriusXM radio.
- 3 Search for a radio station by frequency input.
- 4 Touch to tune to a station in auto seek mode. Touch and hold to switch between auto and manual seek mode.
- 5 Switch between local and distant station reception (only applicable to FM).
- 6 Switch between Stereo and Mono reception (only applicable to FM).
- 7 AS (Auto Scan): Search and store FM or AM stations.

- 8 Touch to tune to a station in auto seek mode. Touch and hold to switch between auto and manual seek mode.
- 9 PS (Preset Scan): Preview each stored station for five seconds. Touch the button again to stop the scan.
- 10 Select a preset sound mode.
- 11 Access radio settings (e.g. RDS/RBDS options). (P.25)
- 12 Access more stored stations.
- 13 Select a preset station. Touch and hold to save the current station as a preset.

### Tune to a Radio Station

In auto seek mode, touch briefly < or > to tune to a station.

Touch and hold < or > to switch between auto and manual seek mode.

**To fine tune a station**, in manual seek mode, touch < or > to change frequencies in steps.

### Auto Store Radio Stations

Touch [AS] on the display. Up to 18 FM or 12 AM stations will be stored.

### Preset a Radio Station

Touch and hold a preset number in the top bar of the display. The current station will be stored as a preset.

### Search via Frequency Input

Touch  to display a numeric keypad. Input a station frequency to find your station.

### FM Local and Distant

Touch  to select local or distant station reception. "LOC" display indicates local reception, "DX" display for distant reception.

Select "DX" when most FM stations are weak (e.g. in the countryside). Stations with both strong and weak signals will be received.

Select "LOC" when most FM stations are strong enough (e.g. in urban areas). Only the stations with strong signal will be received.

### FM Stereo and Mono

Touch  to select Stereo or Mono reception.

When FM signal is weak, select Mono to improve sound quality (stereo will be lost).

# SiriusXM Radio

## Using SiriusXM Radio

SiriusXM is where moments happen. It brings you ultimate entertainment.

- The widest, deepest variety of music, ad-free.
- More games, more sports, more coverage than anywhere.
- The most extensive entertainment, complete news coverage and every kind of comedy.
- Listen in your car, on your phone, online and at home.

A SiriusXM-Connect Vehicle Tuner and subscription are required. For more information, visit [www.siriusxm.com](http://www.siriusxm.com).

## Preparation

### 1. Connect a SiriusXM-Connect Vehicle Tuner (not included) to the SiriusXM-Ready® connector on the back of this unit. (P.35)

After installing your SiriusXM-Connect Vehicle Tuner and antenna, power on the head unit and select SiriusXM mode. You should be able to hear the SiriusXM preview channel on Channel 1.

If you cannot hear the preview channel, please check the installation instructions to make sure your SiriusXM-Connect Tuner is properly installed.

### 2. Check your Radio ID for activation.

The SiriusXM Radio ID is required for activation and can be found by tuning to Channel 0 as well as by looking on the label found on the SiriusXM Vehicle Tuner and its packaging.

- The Radio ID does not include the letters I, O, S or F.

### 3. Activate the subscription.

For users in the U.S.A.:

Visit [www.siriusxm.com/activatenow](http://www.siriusxm.com/activatenow), or call SiriusXM Listener Care at 1-866-635-2349

For users in Canada:

Visit [www.siriusxm.ca/activate](http://www.siriusxm.ca/activate), or call SiriusXM Customer Care at 1-888-539-7474

### 4. Confirm the activation.

As part of the activation process, the SiriusXM satellites will send an activation message to your SiriusXM Vehicle Tuner. When your head unit detects that the Tuner has received the activation message, your head unit will display [Subscription Updated].

Once subscribed, you can tune to channels in your subscription plan. Note, the activation process usually takes 10 to 15 minutes, but may take up to an hour. Your head unit will need to be powered on and receive the SiriusXM signal to obtain the activation message.

## SiriusXM Home Screen

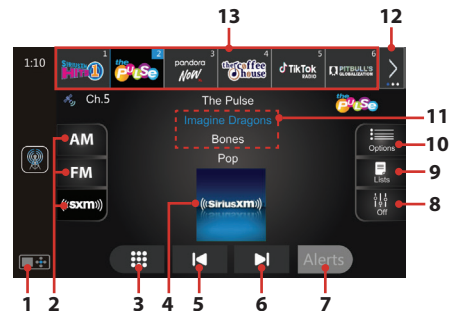

- 1 Return to the home menu.
- 2 Switch between AM, FM and SiriusXM radio.
- 3 Search a channel by input of channel number
- 4 Album Art: Display the image that represents the current music channel. When Album art image is not available, the channel logo or SiriusXM logo will be displayed. Compatible with SXV200 or later (SiriusXM Vehicle Tuner). Not all music channels contain album art images.
- 5 Select the previous channel.
- 6 Select the next channel.
- 7 View the alerts list for the saved artist names and song titles.

# SiriusXM Radio

## Using SiriusXM Radio

- 8 Select a preset sound mode.
- 9 Access alerts/category/channel list to enable alert or select a channel.
- 10 Access SiriusXM radio settings.
- 11 Artist/song name display zone (touch the zone to save the current artist name or song title as alert).
- 12 Access more channel presets.
- 13 Select a stored channel; touch and hold to preset the current channel.  
Channel Logos: Display SiriusXM channel logos to allow for a graphical representation of the current channel identifier.

## Select a Channel

You can select a channel via one of the followings.

- Touch **◀** or **▶** to select the previous or next channel.
- Touch **[Lists]** to access the channel and category lists. Find a channel by category, or artist, song or content info.
- Touch **⋮** to display the numeric keypad. Input a channel number.
- Touch a channel logo at the top of the home screen to select a preset channel.

## Preset a Channel

Touch and hold a preset number in the top bar of the screen. The current channel will be stored as a preset. Repeat the step to preset more channels.

## Artist & Song Alerts

When your favorite artist or song is broadcast on another channel, an alert message will appear to let you switch the current channel to the relevant channel.

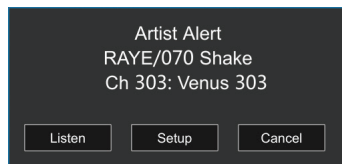

**[Listen]:** Switch to the channel where your set artist or song is being broadcast.

**[Setup]:** Display the alerts setting menu in case of deactivating alert feature.

**[Cancel]:** Skip the alert and stay tuned to the current channel.

## Set Artist & Song Alerts

### Step 1: Save as Alerts

1. When listening to your favorite artist/song, touch the **artist/song name display zone** on the home screen, as shown in the red box below.

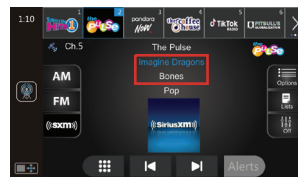

2. An prompt is displayed for you to set artist or song alert.

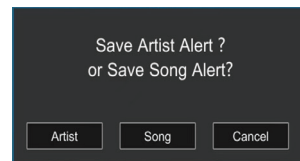

3. Touch **[Artist]** or **[Song]** from the prompt. The artist name or song title will be saved into the alert list.  
Up to 50 artist/song alerts can be saved.

# SiriusXM Radio

## Using SiriusXM Radio

### Step 2: Enable Alerts

1. From the SiriusXM home screen, touch **[Lists]** > **[My Alerts]** to access the alert list where the artist names and song titles are saved.

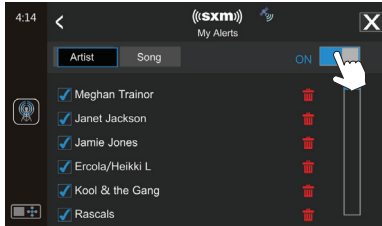

2. Touch **[Artist]** or **[Song]** tab, and select each artist or song from the alert list. A check mark appears beside the selected item.  
To delete an artist or song from the alert list, touch .
3. Enable alert function. Touch **[ON/OFF]** switch on the alert list.

### Parental Control

This feature allows you to restrict access to any SiriusXM channels, including those with mature content. A password is required to tune to a locked channel.

1. From the SiriusXM home screen, touch **[Options]** > **[Parental Control]**. A numeric keypad is displayed.



2. Enter 4-digit password (0000 as default) to access the channel list.
3. In the channel list, select a channel to lock. When a channel is locked, a lock icon is displayed beside the locked channel name.

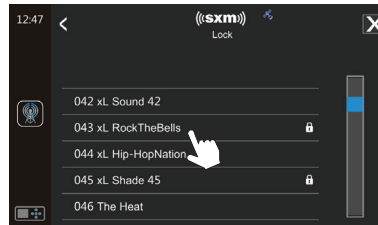

### Change Your Password

You can change the password for the parental control.

From the SiriusXM home screen, touch **[Options]** > **[Change Passcode]**, enter your current 4-digit password (0000 as default), then enter your new password.

# Apple CarPlay

## Using CarPlay

### Apple CarPlay Introduction

CarPlay provides a smarter, safer way to use your iPhone while driving. The apps on your iPhone can be loaded and displayed on the screen of this unit. Thus, you can navigate, call, control you music and so more with hands-free control on your mobile phone.

For more details about Apple CarPlay, visit <http://www.apple.com/ios/carplay>.

### Compatible iPhones

CarPlay works with iPhone 5 and all the way up to the most recent versions.

#### IMPORTANT NOTE

When CarPlay is enabled, hands-free calls and streaming through Bluetooth is disabled.

You can make hands-free calls and streaming through the CarPlay app.

### Connect your iPhone

USB cable connection will enable CarPlay feature. iPhone pairing is not needed.

1. Connect your iPhone to the "Apple CarPlay" USB port, using an Apple-certified lightning cable with factory length or shorter (not included). (P.35)

The apps from the iPhone will be loaded onto the unit.

Touch the **Apple CarPlay** icon on the unit's home menu to access the loaded apps for navigation, phone and music, etc.



- 1 **Menu bar:** Touch an app icon for quick access.
- 2 **CarPlay Home button:** Return to the CarPlay home screen.
- 3 **Unit's Home button:** Exit the CarPlay screen and return to the unit's home menu.
- 4 **Apps loaded from the iPhone.**

### Use Voice Assistant

Press  on the unit's front panel to activate voice assistant, then speak your command.

Make sure the supplied external microphone is connected to the unit. (P.35)

### Change Menu Bar Position

For driving seat convenience, you can change the menu bar from the left side to the right side of the screen and vice versa.

1. From the unit's home menu, select [SETTINGS] > [General] > [Right Hand Drive].
2. Enable or disable the option to change the position of the menu bar. Restart the unit to make the change effective.

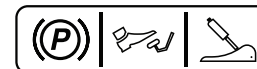

For your safety, park your vehicle in a safe place and engage the parking brake when you make any setup which requires extended time.

# Apple CarPlay

## Using CarPlay

### Arrange your CarPlay Apps

You can add, remove, or arrange the order of the apps on the CarPlay screen of the unit.

1. On your iPhone, go to **Settings > General > CarPlay**, select this unit's name from the device list (shown below). Then select **Customize** to access CarPlay apps.

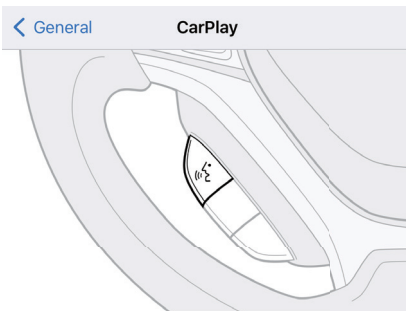

If your car supports wireless CarPlay, press and hold the voice control button on your steering wheel to start CarPlay setup.

MY CAR

BOSS AUDIO BE9ACP.X

2. Touch and drag an app (☰) to change the order of the app.

Touch **−** or **+** to remove and add apps.

Only apps with **−** or **+** can be removed from CarPlay or added in CarPlay.

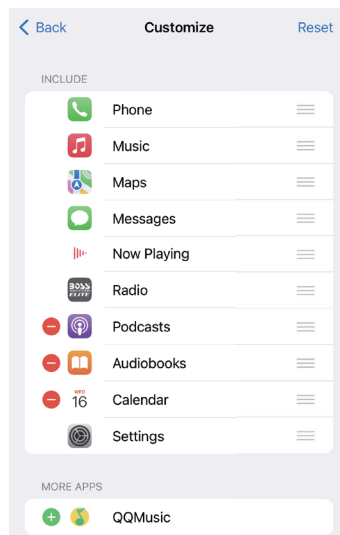

### Disable CarPlay Apps

You can disable all CarPlay apps to restrict CarPlay use on this unit.

On your iPhone, go to **Settings > Screen Time > Contents & Privacy Restrictions > Allowed Apps > CarPlay**.

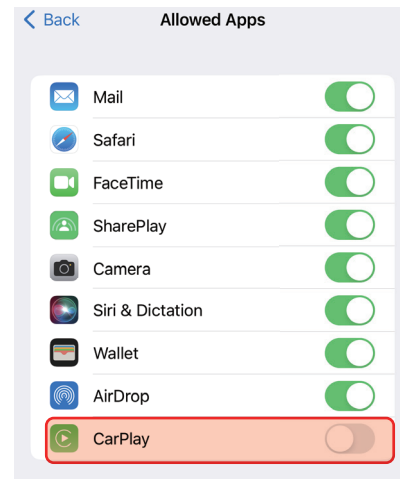

# Android Auto

## Using Android Auto

### Android Auto Introduction

Android Auto allows the apps on your Android phone to be loaded and displayed on the screen of this unit. Thus, you can navigate, call, control you music and so more with hands-free control on your mobile phone.

For more details about Android Auto, visit <http://www.android.com/auto>.

### Compatible Android Phones

Android Auto works with phones running Android 6.0 and later.

### Android Auto App

- Phones with Android 9.0 and earlier needs Android Auto app downloaded from Google Play Store.
- Phones with Android 10 and above do not need to download Android Auto app.

#### **IMPORTANT NOTE**

When Android Auto is enabled, hands-free calls and streaming through Bluetooth is disabled. You can make hands-free calls and streaming through the Android Auto app.

### Connect your Android Device

USB cable connection will enable Android Auto feature. Bluetooth pairing is automatically between the unit and your phone.

1. Connect your Android phone to the "**Android Auto**" USB port, using a certified cable with factory length or shorter (not included). (P.35)

The apps from the Android device will be loaded onto the unit.

Touch the **Android Auto** icon on the unit's home menu to access the loaded apps for navigation, phone and music, etc.

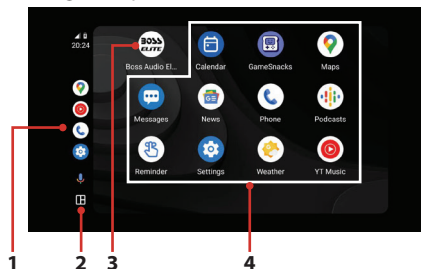

- 1 **Menu bar:** Touch an app icon for quick access.
- 2 **Android Auto Home button:** Return to the Android Auto home screen.
- 3 **Unit's Home button:** Exit the Android Auto screen and return to the unit's home menu.
- 4 **Apps loaded from the Android Phone.**

### Use Voice Assistant

Press  on the unit's front panel to activate voice assistant, then speak your command.

Make sure the supplied external microphone is connected to the unit. (P.35)



For your safety, park your vehicle in a safe place and engage the parking brake when you make any setup which requires extended time.

# Bluetooth

## Connection

### IMPORTANT NOTE

Bluetooth on the unit is enabled only when CarPlay or Android Auto is not connected. Make sure your CarPlay or Android Auto is disconnected for Bluetooth use.

Compatibility with all mobile devices is not guaranteed.

### First Time Connection

When you connect your Bluetooth device to this unit for the first time, pair the device via either of the options below.

Make sure Bluetooth on your device is enabled.

#### Option 1

On your mobile device, go to **Settings** > **Bluetooth**, and select this unit's name (**BOSS AUDIO BE9ACP.X**) to pair.

#### Option 2

From the unit's home menu, touch .

The Bluetooth interface is displayed.

Touch **[Device]** tab, then **[Scan]** to search for available Bluetooth devices, and select your Bluetooth device name to pair.

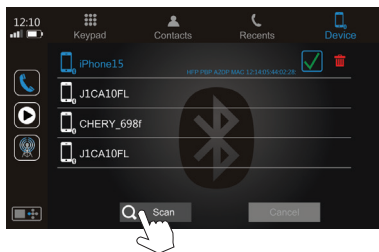

### IMPORTANT NOTE

When prompted during pairing, select **"Allow"** on your mobile phone so that your phonebook and call history can be downloaded and displayed on the screen of this unit.

### Bluetooth Reconnection

After your mobile device is paired with the unit, the two will automatically reconnect each time they are turned on.



For your safety, park your vehicle in a safe place and engage the parking brake when you make any setup which requires extended time.

## Streaming





### Audio Streaming

Before you can stream audio from your mobile device to this unit, make sure Bluetooth connection is made.

1. From the home menu, touch .

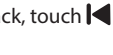
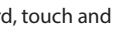
The music from the device plays automatically.

### Playback Control

- To play or pause, touch .
- To skip to the previous or next track, touch .
- To search fast backward or forward, touch and hold .
- To select a repeat mode, touch .
- To turn on or off shuffle play, touch .
- To select a preset sound mode, touch .

### IMPORTANT NOTE

For best performance, your mobile device volume should be set to maximum.

All volume adjustment should be controlled from the unit.

# Bluetooth

## Hands-free Call

### Make a Call

From the home menu, touch .

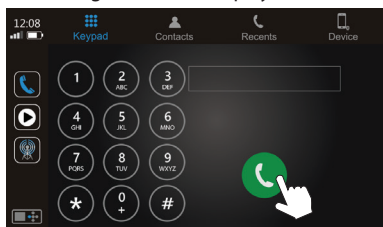

The calling interface is displayed.



### 3 Options to Dial a Bluetooth Call

- Input a phone number on the virtual keypad, and touch .
- Touch [Contacts] tab to access your contact list, then touch a contact.
- Touch [Recents] tab to access your call history, then touch a number.

### Operation During a Call

- To end a call, touch .
- To mute a call, touch .

## Voice Assistant (Push-To-Talk)

### View Connection Status

Touch [Device] tab to display the paired devices.

- A check mark indicates the currently connected device.
- To connect a paired device, simply touch the paired device name.
- To delete a paired device from the memory, touch .



### Voice Assistant (Push-To-Talk)

You can access smartphone voice assistant through the unit.

#### Before you Start

- Enable Bluetooth connection between your smartphone and the unit, or enable Apple CarPlay/Android Auto.
- Make sure the hands-free microphone is connected to the Microphone Input of the unit for audio input. (P.35)

Press  on the unit's front panel to activate voice assistant, then speak your command.

- To use a keypad during a call, touch .
- To switch to private mode, touch . The call will move to your mobile device.
- To return to hands-free mode, touch . The call will move back to the unit.

### Sync Phonebook and History

Touch [Contacts] or [Recents] tab, then [Download].

The phonebook and call history from your mobile phone will be displayed on the unit.

### Search a Contact

Touch [Contacts] tab, then [Search]. The alphanumeric keypad is displayed. Enter a contact name for search.

### Browse Call History

Touch [Recents] tab to display the call history.

Outgoing call



Incoming call



Missed call



# USB

## USB Playback

You can play audio, video and photos stored on a USB flash drive. Make sure your USB flash drive is connected to the front USB-C port or rear USB-A port.

From the home menu, touch .

Music from the device plays automatically.

If there are audio, video and photo files in the USB, audio files will play first.

### Audio/Video/Photo Play Switching

1. In the playback interface, touch . The file browser bar is displayed.



2. Touch [Music], [Video], or [Image] tab to select an audio, video or picture file to play.





#### IMPORTANT NOTE

Video and photo cannot not be viewed while driving. The vehicle must be stationary and the parking brake applied to enable viewing.

To activate viewing, also make sure the parking brake switch wire (Light green) is properly connected to your vehicle. (P.33)

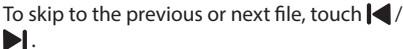
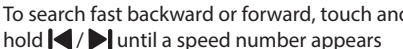

### Audio Playback

In the audio playback interface, playback control is displayed.

- To play or pause, touch .
- To skip to the previous or next file, touch .
- To search fast backward or forward, touch and hold  until a speed number appears then touch repeatedly to select a search speed.
- To select a repeat mode, touch .
- To turn on or off shuffle play, touch .
- To search for a file, touch  then enter a number on the virtual numeric keypad.

### Video Playback

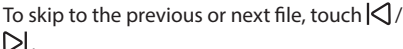
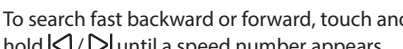
In the video playback interface, touch the screen to display playback control.





- To play or pause, touch .
- To skip to the previous or next file, touch .
- To search fast backward or forward, touch and hold  until a speed number appears then touch repeatedly to select a search speed.
- To select a repeat mode, touch .

### Video Settings

During video playback, touch  to access the Brightness / Contrast / Color settings.

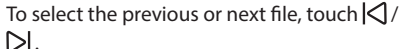
### Photo Playback

In the photo playback interface, touch the screen to display playback control.

- To play or pause, touch .
- To select the previous or next file, touch .
- To select a repeat mode, touch .
- To enlarge the picture, touch  then drag the magnifying slider.
- To rotate the picture, touch .

#### WARNING

Watching video or photo while driving is against Federal, State, and Local laws.

Do not use features of this unit if it cannot be operated safely and legally in your location.

# Other External Devices

## Audio/Video Input

### Playback

From the home menu, touch  .

Audio and video input screen is displayed.

### Audio Input

You can listen to an audio device (e.g. a mobile phone or MP3 player) through this unit.

### Audio Cable Connection

Connect the RCA inputs ("L-IN" and "R-IN") on the unit's back to the audio output on your device. (P.34)

If your device does not have an RCA, use the following audio cable (not included).

- For a device with 3.5mm headphone jack, use a 3.5mm to RCA audio cable.
- For a device with USB-C port, use a USB-C to RCA audio cable..

### Video Input

You can play video from a playback device (e.g. a CD/DVD, etc.).

### AV Cable Connection

Using audio/video cables (not included), connect the RCA inputs ("L-IN", "R-IN" and "V-IN") on the unit's back to the RCA outputs (yellow/white/red) on your playback device. (P.34)

#### IMPORTANT NOTE

Use the controls on the external device for playback control.

Video and photo cannot not be viewed while driving. The vehicle must be stationary and the parking brake applied to enable viewing.

To activate viewing, also make sure the parking brake switch wire (Light green) is properly connected to your vehicle. (P.33)

#### WARNING

Never rely solely on the backup camera; always check your surroundings before backing up.



Images may appear reversed if your camera is not properly installed or set up.

Do not use features of this unit if it cannot be operated safely and legally in your location.

## Camera

Make sure front/rear camera connection is correctly made. (P.35)

### Manual Camera Trigger

From the home menu, touch the rear camera icon () or the front camera icon () to display the camera view.

**Note:** If the camera icon is grayed out, enable the camera input. From the home menu, touch [SETTINGS] > [Camera].

On the camera view screen, touch the camera icon to switch between front and rear camera view.

### Automatic Camera Trigger

When the vehicle is put into reverse gear, the rear camera view will turn on automatically. The front camera view is not accessible when reversing.

#### IMPORTANT NOTE

For automatic rear camera trigger, make sure the purple/white wire (labeled "REVERSE") is connected to the reverse light. (P.31)

# Sound Settings

## Set Sound Effects

From the home menu, touch [SETTINGS] > [Audio] > [EQ] to access sound settings.

### Sound Mode and Equalizer Setting



To select a preset sound mode (Jazz, HipHop, Pop, Rock or R&B), touch ◀ or ▶.

To customize equalizer setting, touch ◀ or ▶ until [Custom] appears then swipe up or down each frequency bar to adjust decibel output.

### Volume Balance Setting



Touch ▲ or ▼ to adjust front and rear volume balance until the sound has a satisfying depth.

Touch ◀ or ▶ to adjust right and left volume balance until you are pleased with the sound and a suitable balance is found.

### Crossover Frequency Setting

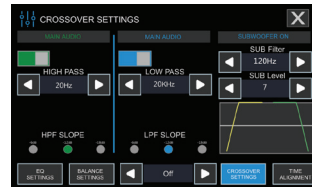

[HIGH PASS]: Adjust High Pass Filter (HPF) for main audio (radio and media play). Only the frequencies above the one you set will be received to reproduce sound.

[LOW PASS]: Adjust Low Pass Filter (LPF) for main audio (radio and media play). Only the frequencies below the one you set will be received to reproduce sound.

[HPF SLOPE]: Set a high pass filter slope in decibels. An HPF slope determines the rate that attenuates the frequencies below the set one.

[LPF SLOPE]: Set a low pass filter slope in decibels. A LPF slope determines the rate that attenuates the frequencies above the set one.

[SUB Filter]: Adjust the cutoff frequency for the subwoofer. Only the frequencies below the one you set will be received to reproduce sound.

[SUB Level]: Adjust volume output for the subwoofer.

### Time Alignment Setting

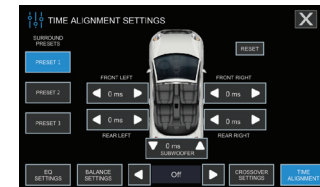

Adjust sound delay time so that sound from all the speakers arrives at the listener simultaneously.

1. Touch a preset button for settings as a listening position. Total three presets can be stored as different listening positions.
2. Touch ◀ or ▶ to set delay time for front and rear speakers, and touch ▲ or ▼ for the subwoofer.

Experiment with different time values to find the optimal settings for you.

To clear the set values, touch [RESET].

# System Settings

## General Settings

From the home menu, touch [SETTINGS] > [General] to access general settings.

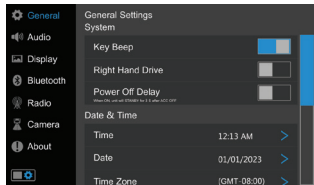

### System Tone and Shutdown Delay

[Key Beep]: Enable or disable touch sound.

[Right Hand Drive]: Change the Apple CarPlay menu bar from the left side to the right side of the screen and vice versa. Restart your vehicle to make the change effective.

[Power Off Delay]: Enable to keep the unit on for three seconds after accessory power or vehicle is turned off.

Enable shutdown delay if the unit restarts during vehicle's crank to start.

### Set Date and Time Manually

[Time]: Touch to access time setting screen. Swipe the time field up and down to set hours, minutes, and 12/24 hour format respectively.

[Date]: Touch to access date setting screen. Swipe the date field up and down to set year, month, and day respectively.

[Time Zone]: Select a time zone in your current location.

[Daylight Savings Time]: Enable to adjust Daylight Saving automatically.

### Set Date and Time Automatically

[Projection Clock Sync]: Enable to automatically set date and time from Apple CarPlay.

[Set Automatically by RDS/RBDS]: Enable to set date and time from RDS/RBDS radio broadcast.

### Language Setting

Select English or Spanish as menu language.

### Steering Wheel Control Retention

The unit allows you to retain your steering wheel controls (SWC), via **A**) connection to a steering wheel interface (not included) or **B**) directly to your steering wheel control harness if compatible with the SWC Learning Setup. (P.31)

[SWC Fixed Settings]: Select this option if your vehicle needs a steering wheel interface (not included). (P.31)

Follow the instructions of your steering wheel interface to program the unit's audio and video functions on your steering wheel controls.

[SWC Learning Setup]: Select this option to access function programming if your vehicle does not need a steering wheel interface for SWC connection. (P.31)

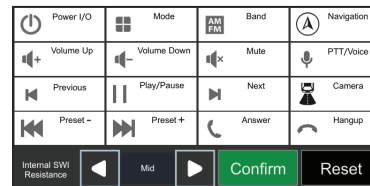

1. Touch [Reset] to enable programming mode.
2. Touch a function from the mapping chart, then hold down a button on the steering wheel to set the function. If programming fails, touch ◀ or ▶ to try low, mid or high resistance option for programming success.
3. Repeat Step 2 to program the other functions. After all mappings complete, touch [Confirm].

### IMPORTANT NOTE

The mapping tool with resistance options is not compatible with all vehicles. If programming fails after trying low, mid and high resistance options, your vehicle needs a steering wheel interface (not included) for SWC retention.

# System Settings

## Audio Settings

From the home menu, touch [SETTINGS] > [Audio] to access audio settings.

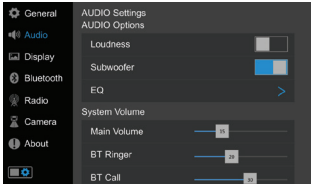

### Loudness and Sound Effect Setting

**[Loudness]:** Enable to boost output of low and high frequencies.

**[Subwoofer]:** Enable or disable subwoofer output.

**[EQ]:** Touch to access the following sound effects settings. (P.21)

- Sound Mode and Equalizer
- Volume Balance
- Crossover Frequency
- Time Alignment

### Startup Volume Setting

**[Main Volume]:** Set a desired volume for main audio (radio and media play) when the unit starts up with main audio.

1. Adjust the slider to set a new volume value.
2. Startup volume will be the set volume if the set volume is less than the last shutdown volume (as main audio).  
Startup volume will be the last shutdown volume if the set volume is greater than the last shutdown volume (as main audio).

### Initial Volume Setting for Other Sources

You can set desired initial volumes for the following sources.

- **[BT Ringer]:** Bluetooth ringtone volume.
- **[BT Call]:** Bluetooth call volume.
- **[Navi]:** Navigation volume.
- **[Voice]:** Voice assistant volume.

1. Adjust the respective slider to set a new volume value.

2. Initial volume will be the set volume if the set volume is less than the last used volume.  
Initial volume will be the last used volume if the set volume is greater than the last used volume.

### Customization of a Source Volume

You can increase or decrease one of the following source volumes, without affecting volume of other sources:

- **[Radio]:** Adjust radio volume alone.
- **[USB]:** Adjust USB playback volume alone.
- **[BT Audio]:** Adjust Bluetooth streaming volume alone.
- **[AV IN]:** Adjust audio input volume alone for RCA connection.
- **[Apple CarPlay]:** Adjust CarPlay volume alone.
- **[Android Auto]:** Adjust Android Auto volume alone.

# System Settings

## Display Settings

From the home menu, touch [SETTINGS] > [Display] to access display settings.

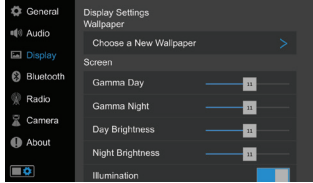

### Wallpaper Setting

[Choose a New Wallpaper]: Change a wallpaper for home, radio, or media playback screen.

### Screen Setting

[Gamma Day]: Change the differences between dark and light area. Applicable when your vehicle light is turned off.

[Gamma Night]: Change the differences between dark and light area. Applicable when your vehicle light is turned on.

[Day Brightness]: Adjust screen brightness. Applicable when your vehicle light is turned off.

[Night Brightness]: Adjust screen brightness. Applicable when your vehicle light is turned on.

## Bluetooth Settings

Make sure CarPlay or Android Auto is not connected to enable unit's Bluetooth.

From the home menu, touch [SETTINGS] > [Bluetooth] to access Bluetooth settings.

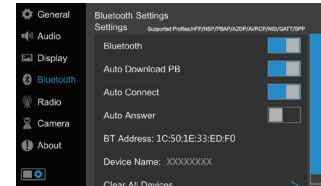

[Bluetooth]: Enable or disable Bluetooth function.

[Auto Download PB]: Enable to download the phonebook from the connected mobile phone.

[Auto Connect]: Enable to automatically connect the paired Bluetooth device.

[Auto Answer]: Enable to automatically answer an incoming call.

[BT Address]: Show the unit's Bluetooth address.

[Device Name]: Show the unit's Bluetooth name.

[Clear All Devices]: Clear all the paired Bluetooth devices from the unit's memory.

### Automatic Dimming Control

[Auto Dimming Control]: When enabled and the vehicle light is turned on, the screen brightness and panel button lights will automatically dim.

#### IMPORTANT NOTE

To enable night detection and auto dimming, make sure the orange/white wire (labeled "DIMMER INPUT") is connected to your vehicle's parking light. (P.31)

### Panel Button Light Setting

[Preset Color]: Select one of six colors for panel button lights. Make sure [Animation Effect] option is disabled to make the feature active.

[Animation Effect]: Enable to automatically cycle the panel button lights through six different colors.

### Underglow Brightness Control

[Ambient Light Brightness]: Adjust the brightness of the underglow lights. The underglow lights are set to sync and match the button illumination color.

# System Settings

## Radio Settings

From the home menu, touch [SETTINGS] > [Radio] to access radio settings.

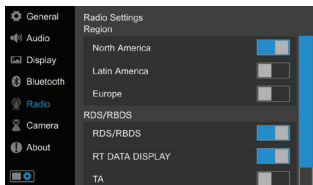

### Radio Region Selecting

Select a radio region where your unit is in.

**[North America]:** Enable if you are in this area.  
Tuner spacing: FM (200 kHz), AM (10 kHz)

**[Latin America]:** Enable if you are in this area.  
Tuner spacing: FM (100 kHz), AM (10 kHz)

**[Europe]:** Enable if you are in this area.  
Tuner spacing: FM (50 kHz), AM (9 kHz)

### RDS/RBDS Activation

**[RDS/RBDS]:** Enable or disable RDS/RBDS function.

When disabled, the unit will not receive RDS/RBDS service carried by FM radio signals.

### RDS/RBDS Information Display

**[RT DATA DISPLAY]:** Enable or disable a service that allows FM stations to display additional information (i.e. station name, program type or other dynamic/static message).



Not all FM stations will have or display RDS/RBDS information.

### RDS/RBDS Traffic Announcement

**[TA]:** When enabled, the unit will automatically tune in to traffic information broadcast despite the media source you are currently in.

Once the traffic announcement ends, the original source will automatically resume.

### RDS/RBDS Alternative Frequency

**[AF]:** When enabled, the unit will automatically locate the same tuning program on other stations and select the strongest signal of those being broadcast.

This feature is most useful on long trips when your car goes out of the range of a radio station.

## Camera Settings

From the home menu, touch [SETTINGS] > [Camera] to access camera settings.

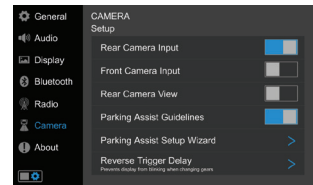

### Camera Trigger Control

**[Rear Camera Input]:** Enable or disable rear camera signal input.

**[Front Camera Input]:** Enable or disable front camera signal input.

**[Rear Camera View]:** When enabled, the rear camera view will be laterally (left/right) inverted.

**[Reverse Trigger Delay]:** Delay trigger of rear camera view by a set time. A proper time setting prevents the unit's screen from blinking when shifting gears.



For automatic rear camera trigger, make sure the purple/white wire (labeled "REVERSE") is connected to the reverse light. (P.31)

# System Settings

## Camera Settings

### Parking Assist Guidelines Setting

**[Parking Assist Guidelines]:** Disable the parking assist guidelines built in the unit if your rear camera view has its own parking assist guides.

**[Parking Assist Setup Wizard]:** Adjust the parking assist guidelines built in the unit.

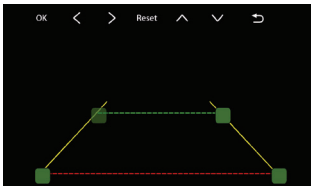

Touch and drag a square icon to reposition the related guideline. Repeatedly touch an arrow icon to fine tune positioning of the related guideline. Touch **[OK]** to confirm the adjustment.

To reset to the default positioning of the guideline, touch **[Reset]**.

## System Information

From the home menu, touch **[SETTINGS]** > **[About]** to access system information.

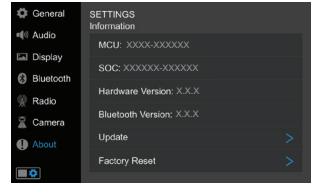

### Firmware Version Information

Version information starts with **MCU**, **SOC**, **Hardware Version**, or **Bluetooth Version**.

### Firmware Update

We continually try to improve our product. The product can be updated if needed.

**[Update]:** Touch to prompt firmware update.

Make sure a USB flash drive with a newer firmware is connected to the unit's rear USB port (not the front USB-C port). The firmware file must be saved in the root directory of the USB flash drive. Unzip the file and make sure the file name shows "BIN" extension after zipping.

### Resetting the Unit

**[Factory Reset]:** Reset the unit to the factory settings.



Reset the unit only when the unit fails to function normally. All your settings will be erased after resetting.

# Unit Installation

## Dash Mounting



**WARNING**

See the section "Installation Warnings". (P.4)

### Single DIN Opening Installation

This section explains the installation if your vehicle has a single DIN dash opening (2" x 7").

1. Remove the trim ring from the front panel:  
Use a plastic pry tool to pry open the trim ring.
2. Remove the mounting cage from the unit:  
Insert the two supplied release keys into the locking tabs on both sides of the unit, then pull the mounting cage off.

Then secure the mounting cage into the dash opening. Bend the tabs on the mounting cage to lock the cage into place.

3. Insert the unit into the dash opening/  
mounting cage.
4. Secure the supplied mounting strap to the rear of the unit to provide extra fastening (if your car does not have a rear bracket to fix the unit).

Use the supplied hex bolt, hex nut (a), spring washer (b), plain washer (c), tapping screw to fix the mounting strap.

Replace the trim ring after the installation.

Before you mount the unit into the dash, complete the wiring connection (P. 31 to 36).

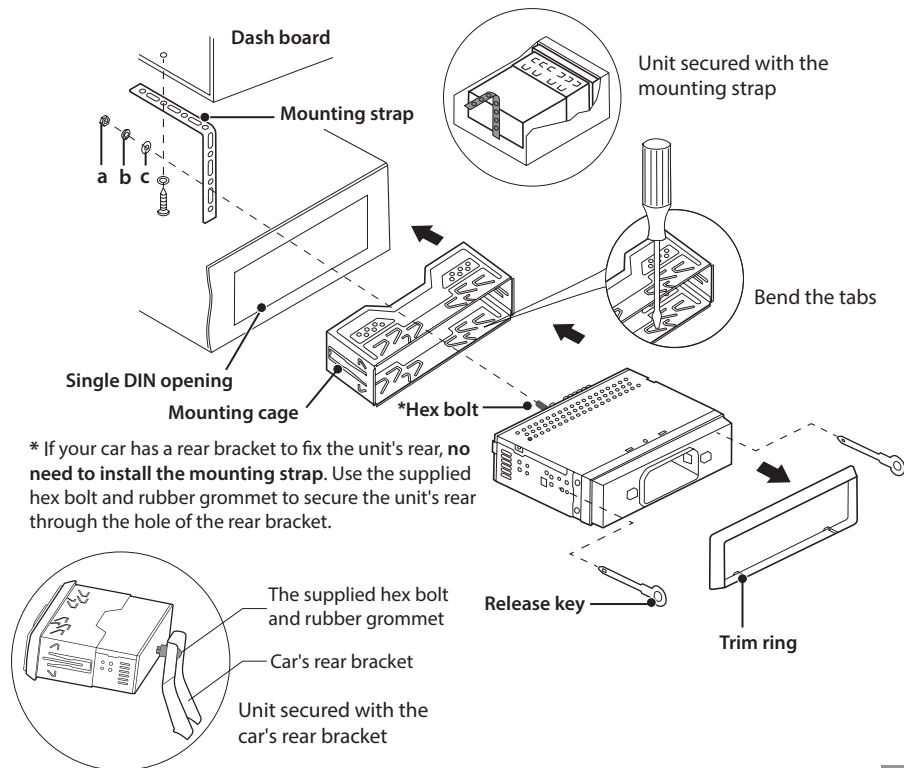

# Unit Installation

## Dash Mounting

### Double DIN Opening Installation

This section explains the installation if your vehicle has a double DIN dash opening (4" x 7").

1. Remove the trim plate and the mounting cage from the unit, as described in the section "Single DIN Opening Installation".
2. Attach the two supplied L-brackets to the both sides of the unit, using the supplied bolts and the screw holes on both sides of the unit.

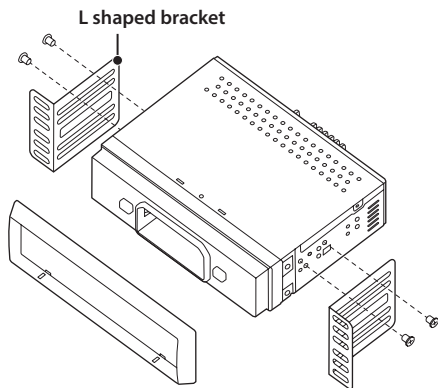

3. Slide the unit into the dash opening. Then fix the unit by fastening the L-brackets around the dash opening with proper screws (not included). Consult a professional installer on whether screw hole drilling is required.
4. Replace the trim plate after the installation.

### Attach the Display

As illustrated below, insert the supplied display into the head unit until it clicks.

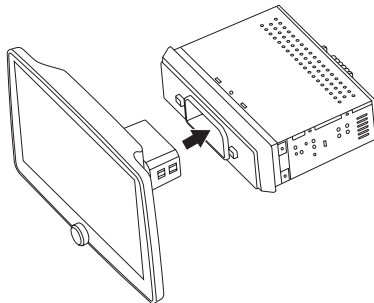

## Display Assembly

### Detach the Display

As illustrated below, hold down two release buttons simultaneously to unlock the display then pull the display out.

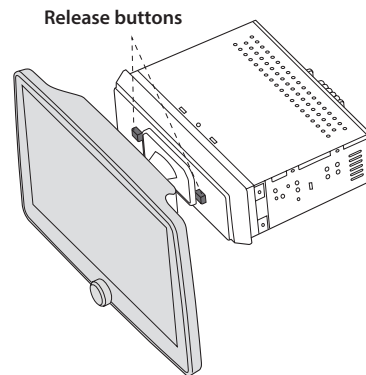

# Unit Installation

## Display Positioning

### Adjust Positioning of the Display

Adjust the display angle so that your view is clear and it does not impair your driving.

### Adjust the Display Height

Hold the display then slide it up or down to adjust the height.

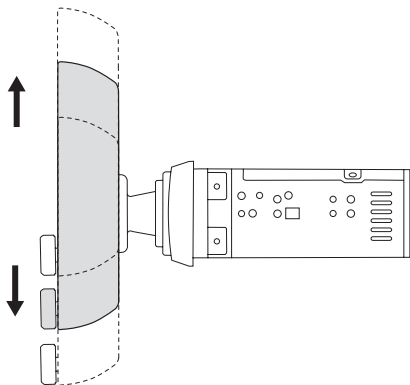

### Tilt the Display Up and Down

The display can be vertically tilted by 25 degrees.

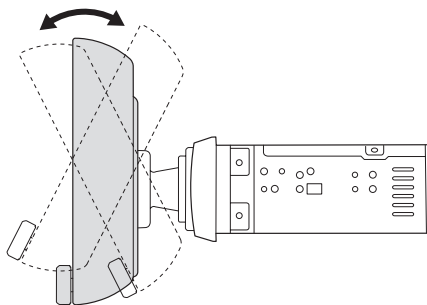

### Tilt the Display Left and Right

The display can be horizontally tilted by 15 degrees.

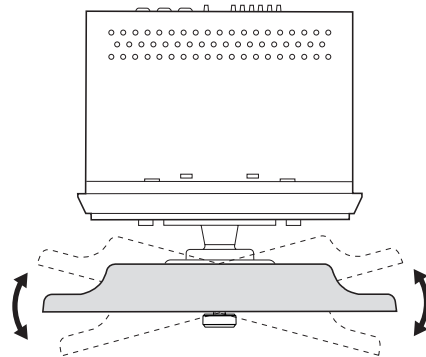

# Unit Installation

## Installation Dimensions

### Chassis Mounting Dimensions

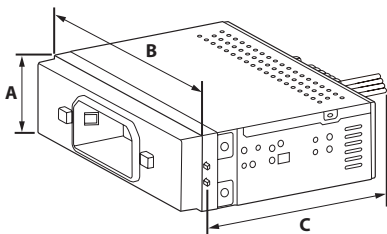

**A x B** (Mounting hole): 1.97" x 7.01" (50 x 178 mm)

**C** (Mounting depth): 5.93" (150.5 mm)

### Display Dimensions

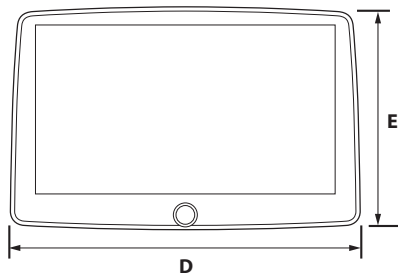

**D**: 9.29" (236mm)

**E**: 6.34" (161mm)

### Display Mounting Dimensions

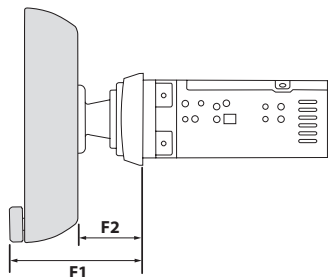

**F1**: 3.54" (90 mm)

**F2**: 1.85" (47 mm)

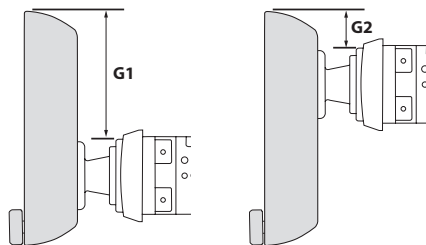

**G1** (at highest position): 3.35" (85mm)

**G2** (at lowest position): 1.57" (40mm)

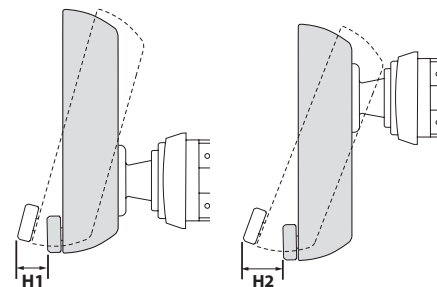

**H1** (with maximum tilting angle at highest position): 0.59" (15mm)

**H2** (with maximum tilting angle at lowest position): 1.34" (34mm)

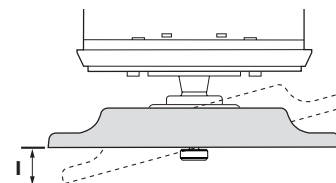

**I** (with maximum tilting angle): 1.14" (29mm)

# Connections

## Power and Steering Wheel Control (SWC) Input Wiring

### WARNING

See the section "Installation Warnings". (P.4)

### IMPORTANT NOTE

Unused input/output wires need to be insulated with tape, heat shrink, or crimp connectors. **Never use wire nuts.**

Always replace the faulty fuse with the same type and rating (15A).

"DIMMER INPUT" wire (Orange/white) must be connected to the parking light for night detection and auto dimming in screen and panel button lights.

"REVERSE" wire (Purple/white) must be connected to the reverse light wire for automatic rear camera trigger when the gear is changed to reverse.

\* Power output is max. 500mA, 12V. It is recommended to use a relay if additional power is required.

\*\* Consult a professional installer for a correct steering wheel interface or the supplied 3.5mm SWC cable wiring. Follow the instructions of the steering wheel interface to complete wiring.

\*\*\* Noise filter box.

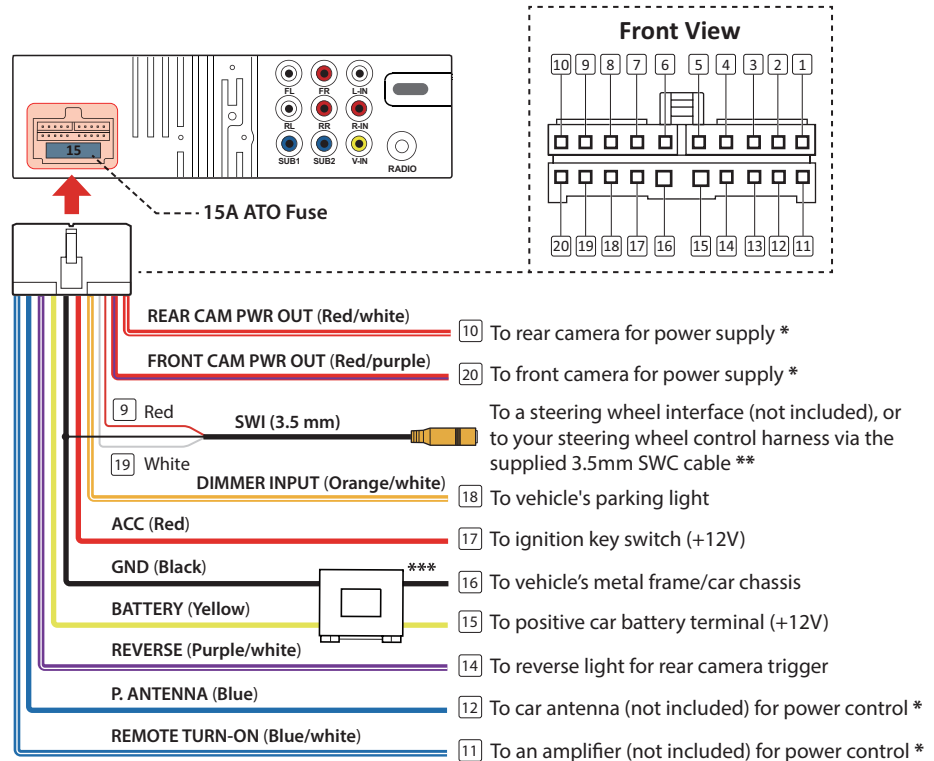

# Connections

## Speaker Wiring

### CAUTION

Do not chassis ground any speaker wire leads.  
Only use 4-8  $\Omega$  speakers.  
**DO NOT** use 1-3  $\Omega$  speakers.  
Do not bridge any of the channels. They are only to be wired in stereo mode.

### IMPORTANT NOTE

Unused speaker wires need to be insulated with tape, heat shrink, or crimp connectors to avoid damage to the unit. **Never use wire nuts.**  
Double check speaker polarity when making connections.

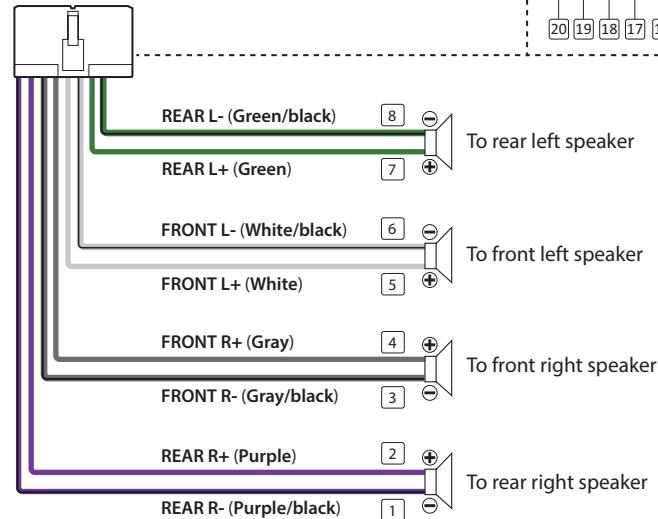
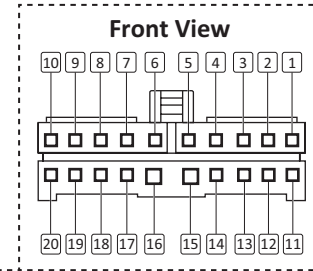
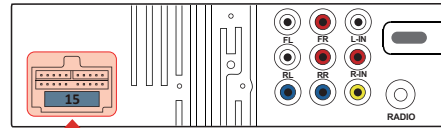

# Connections

## Parking Brake Wiring

### IMPORTANT NOTE

Video and photo playback can be enabled only when the parking brake switch wire is connected to your vehicle, and the vehicle's parking brake is engaged.



Park your vehicle in a safe place and engage the parking brake to view video and photo.

### WARNING

Improper connection or use of the parking brake switch wire (e.g. defeating the safety feature) violates Federal, State, and Local laws. This may lead to injury, property damage, and/or death.

Watching videos or photos while driving is against Federal, State, and Local laws.

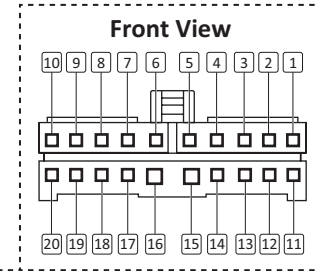
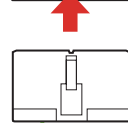
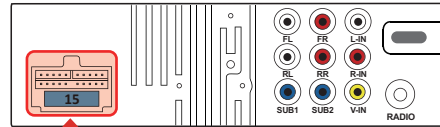

PARKING SW (Light green)

Parking brake switch wire

13 To vehicle's parking brake switch

### Note

Parking brake switch location varies from vehicles. Consult a professional installer.

# Connections

## AV/Radio

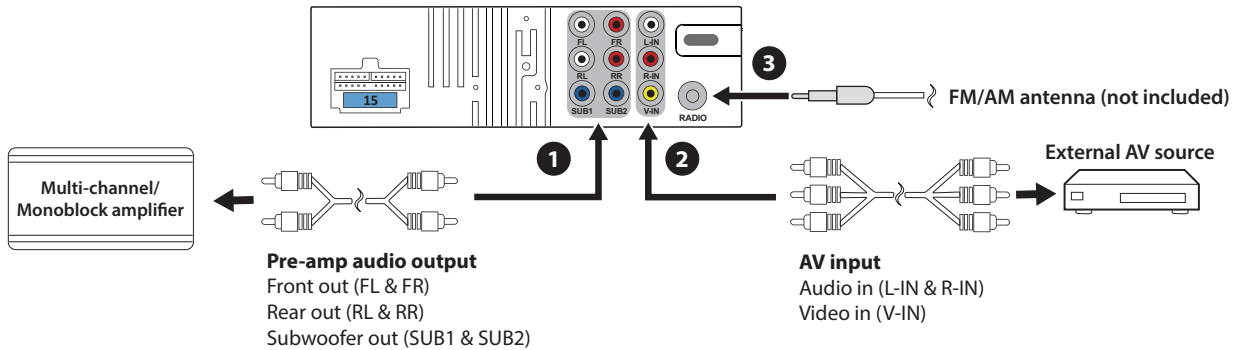

### IMPORTANT NOTE

Subwoofer pre-amp is a non-fading mono output.

Always run signal wires away from power cables to reduce the possibility of noise.

**1** Using RCA audio cables (not included), connect the audio output on the unit to an external amplifier (not included).

**2** Using RCA audio cables (not included), connect the audio input ("L-IN" and "R-IN") on the unit to the audio output on an external AV source.  
Or using an RCA to 3.5mm/USB-C/lightning adapter (not included), connect the audio input ("L-IN" and "R-IN") to the audio output on your mobile phone.

Using a yellow RCA cable (not included), connect the video input ("V-IN") on the unit to the video output on an external AV source.

**3** Connect an FM/AM antenna (not included) for better radio reception.

# Connections

## SiriusXM/Mic/Camera/CarPlay/Android Auto

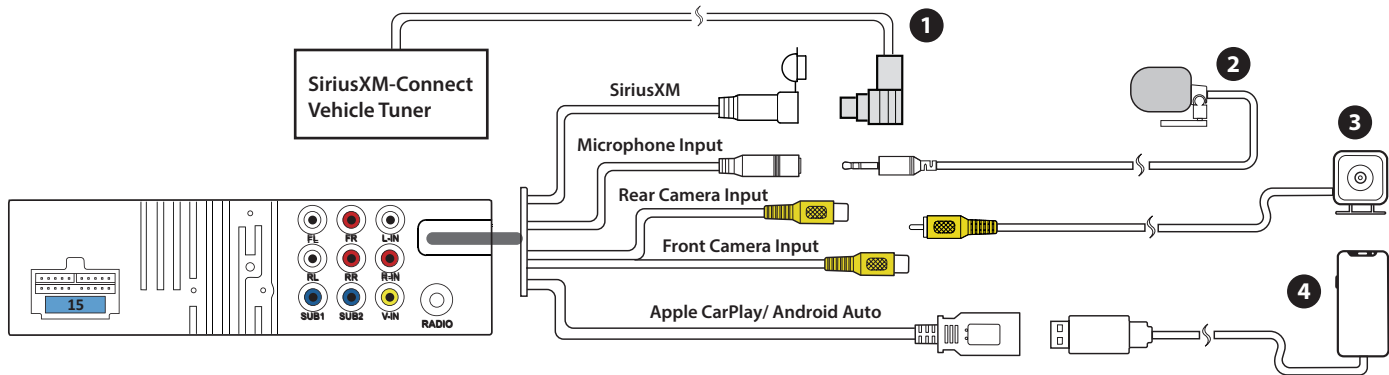

- 1 Connect a SiriusXM-Connect Vehicle Tuner (not included) before you can activate and receive satellite radio.

For more information on how to install the SiriusXM Vehicle Tuner, consult the SiriusXM Vehicle Tuner Installation Guide.

- 2 Connect the 3.5mm plug of the supplied hands-free microphone for sound input when using phone call or voice assistance through Bluetooth or CarPlay/Android Auto.

- 3 Connect the RCA plug of your camera for video signal input.  
To operate your rear camera, you also need to connect camera power and reverse signal. (P.31)  
Refer to the installation instructions of your camera for installation.

- 4 Connect the lightning cable or USB cable of your iPhone or Android device to enable use of CarPlay or Android Auto.  
You may also connect a USB flash drive for media playback.



### WARNING

Never rely solely on the backup camera. Always check your surroundings before backing up.

Images may appear reversed if your camera is not properly installed or set up.

Do not use features of this unit if it cannot be operated safely and legally in your location.

# Connections

## Hands-Free Mic Installation

### Placement

The unit comes with a hands-free microphone with sticky base and 10ft wire.

The location of the microphone can vary from different vehicles due to layout, interior materials, etc.

The **Red** shaded areas are the recommended locations for best microphone performance.

Items to look for before placement:

- Do not place in front of air vents.
- If the vehicle has tweeters placed on sail panel, do **NOT** locate the microphone on steering column area.
- The front of the microphone must not be blocked.
- Microphone should be firmly attached to mounting location.
- Do not cover the grille openings surrounding the microphone.
- To avoid excessive wind noise, do not place near the sunroof opening.

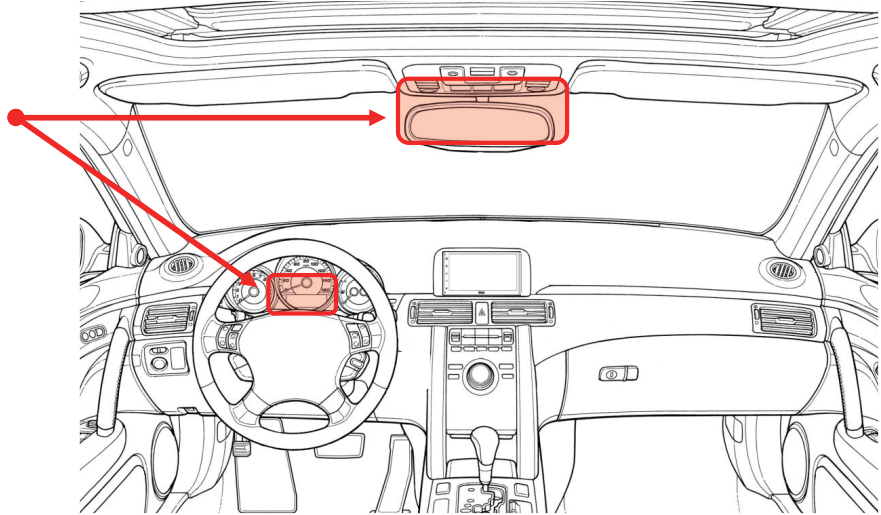

### Attach the Microphone

1. Clean the mounting surface.
2. Remove the backing paper from the microphone base, then stick the base onto the mounting surface.
3. Route and secure the microphone wire properly.



#### WARNING

Run the microphone wire where it will **NOT** impede with the operation of any safety items (e.g. airbags, knee airbags, etc.)

# Troubleshooting

## Important!

If you have checked the points described in the list and the problem persists, turn off the vehicle for ten seconds then turn it back on again. If the problem still persists after restarting the unit, reset the unit by using a small pin to press the reset button on the bottom side of the display. If you still have problems after applying suggestions above, please contact our Customer Service for further assistance.

## General

### No response / Screen or unit not powered on / Bad or incorrect picture quality.

- Restart the unit by turning off the vehicle for ten seconds, then turning the vehicle back on.

### No sound from the unit.

- The unit is muted. Adjust the volume.
- Select the correct audio source on the unit.

## USB

### Cannot play a media file.

- The file format on the USB flash drive is not supported by the unit. Change media files.
- The file system of the USB flash drive is not supported by the unit. Change the USB drive.

### No video playback or picture display.

- Video or picture display is enabled only when the parking brake is engaged, and the parking brake switch wire is connected to your vehicle. (P.33)

## Apple CarPlay/Android Auto

### Cannot start Apple CarPlay/Android Auto.

- Bad USB cable. Replace the cable.
- The mobile phone is locked. Unlock it.
- CarPlay/Android Auto is frozen. Unplug the mobile phone, close all apps and plug the phone in again.

## Bluetooth

### Cannot stream via Bluetooth.

- Make sure your mobile phone is within Bluetooth range.
- Pair and connect your mobile phone. (P.17)
- CarPlay or Android Auto is being connected. Unplug your mobile phone from the unit to enable Bluetooth connection.
- Delete the paired device on both your phone and the unit. Make the connection again.

### Poor hands-free phone call quality.

- Check signal strength on your mobile phone.
- Check that the microphone is firmly attached

and plugged in. Or relocate the microphone for noise reduction. (P.36)

### Cannot make Bluetooth connection.

- CarPlay/Android Auto connection disables Bluetooth on the unit. Unplug CarPlay or Android Auto from the unit to enable Bluetooth connection.
- The unit is already connected to a mobile device. Disconnect the current Bluetooth connection before connecting to another Bluetooth device.
- Delete the paired device on both your phone and the unit. Make the connection again.

## FM/AM Radio

### Poor radio reception.

- FM/AM antenna is not connected or extended. Connect and secure an FM/AM antenna (not included). (P.34)
- The antenna output wire is not connected. Connect the wire. (P.31)
- Turn off RDS/RBDS, TA and AF. (P.25)

# Troubleshooting

## SiriusXM Radio

### "Check Antenna" appears.

- Check that the antenna cable is connected to the SiriusXM-Connect Vehicle Tuner.
- Check the antenna cable for damage and kinks. Replace the antenna cable if damaged. SiriusXM products are available at your local car audio retailer or online at <https://shop.siriusxm.com/all-parts/>.

### "Check Tuner" appears.

- Check that SiriusXM-Connect Vehicle Tuner is securely connected to the unit (*P.35*), or the Tuner is damaged.

### "Subscription Updated" appears.

- Your subscription is updated. Press the appropriate button to clear the message.

### "Channel Unavailable" appears.

- The selected channel is not available. For more information about SiriusXM channel lineup, visit [www.siriusxm.com](http://www.siriusxm.com).

### "No Signal" appears.

- Verify that your vehicle is outdoors with a clear view of the sky.
- Verify that the SiriusXM magnetic base antenna is mounted on a metal surface on the outside of the vehicle.
- Move the SiriusXM antenna away from any obstructions.
- Check the antenna cable for damage and kinks.
- Consult the SiriusXM-Connect Vehicle Tuner installation manual for more information on antenna installation.

### "Channel Unsubscribed" appears.

- The selected channel is not subscribed.  
If you have questions about your subscription package or would like to subscribe to this channel, in the USA, visit [www.siriusxm.com](http://www.siriusxm.com) or call 1-866-635-2349; in Canada, visit [www.siriusxm.ca/activate](http://www.siriusxm.ca/activate) or call 1-888-539-7474.

### "Channel Locked" appears.

- The selected channel is locked by the Parental Control feature. Enter the correct password to unlock. (*P.13*)

# Specifications

## General

Input voltage.....	8.5 – 18 VDC 14.4 VDC (Nominal)
Current consumption .....	Max. 15 A
Fuse .....	15 A (ATO, blade)
Mounting hole (H x W).....	1.97" x 7.01"
Mounting depth .....	5.93"
Unit weight.....	3.91 lbs.
Operational temperature .....	-4 – 140°F

## Display

Screen size .....	9"
Aspect ration.....	16:9
Resolution .....	1024 x 600
Screen type.....	TFT-LED active matrix

## Audio

Max power .....	85 W x 4
Speaker impedance.....	4 – 8 Ω
Preset EQ.....	Jazz, HipHop, Pop, Rock, R&B
EQ bands (Adjustable).....	32/63/125/250/500 Hz 1/2/4/8/10/12/14/16 kHz
EQ boost/cut .....	±6 dB
High pass filter (HPF).....	20/60/80/160/250 Hz
Low pass filter (LPF).....	2/8/10/16/20 kHz
HPF/LPF slope.....	-6/-12/-18 dB

Sub filter.....	50/80/120/160 Hz
Sub level .....	+1 to +14 dB
Pre-amp output.....	2x Front (4V, full range) 2x Rear (4V, full range) 2x Sub (mono, 4V, LPF)
Audio input.....	2x RCA, 1 Vp-p/75 Ω

## Video

Signal system .....	NTSC/PAL
Video input (RCA).....	1x RCA, 1 Vp-p/75 Ω

## Radio

Frequency range.....	87.5 – 108 MHz (FM) 522 – 1710 kHz (AM)
Frequency step (FM).....	200 kHz (USA) 100 kHz (Latam) 50 kHz (Europe)
RDS/RBDS.....	RT data , TA, AF

## Apple CarPlay

Device support.....	iPhone 5 or later
iOS.....	iOS 7.1 or later

## Android Auto

Android .....	6.0 or later
---------------	--------------

## USB

Front USB port .....	USB-C Media/Charging (1.5A)
Rear USB port.....	USB-A (2.0, High Speed) CarPlay/Android Auto Charging (1.5A)
Supported USB device.....	Max. 32GB
File system.....	FAT32
Audio playback.....	MP3, WMA, WAV, FLAC (192kHz/24bit)
Video playback.....	AVI, MKV, WMV
Picture playback.....	JPG, PNG, BMP

**Note:** Not all listed media files are guaranteed to play due to different creation methods or file contents.

## Bluetooth

Bluetooth version.....	V5.2 + EDR
Transmission range.....	33ft/10m (line of sight)
Bluetooth profiles.....	A2DP, AVRCP, HFP, PBAP, HSP, HID, GATT, SPP

*Specifications are subject to change without notice.*



BOSS Audio Systems  
3451 Lunar Court • Oxnard, CA 93030  
[www.bossaudio.com](http://www.bossaudio.com)  
**805-751-4853 Customer Service**  
**Tech Support: [www.bossaudio.com/support](http://www.bossaudio.com/support)**



0724

iPhone® is a trademark of Apple Inc., registered in the U.S. and other countries. Apple CarPlay is a trademark of Apple Inc. BOSS Audio Systems is not affiliated with Apple Inc.

The Bluetooth® word mark and logos are registered trademarks owned by Bluetooth SIG, Inc. and any use of such marks by BOSS Audio Systems is under license. Other trademarks and trade names are those of their respective owners.

Android Auto is a trademark of Google LLC.

Use of the Apple CarPlay logo means that this user interface meets Apple performance standards. Apple is not responsible for the operation of this device or its compliance with safety and regulatory standards.

SiriusXM-Ready and all related marks and logos are trademarks of Sirius XM Radio, Inc. All rights reserved. SiriusXM-Ready allows you to listen to ad-free music, plus all the sports, talk, comedy, news coverage, and all in one place. (SiriusXM Connect Tuner and Subscription required. Sold Separately.)