

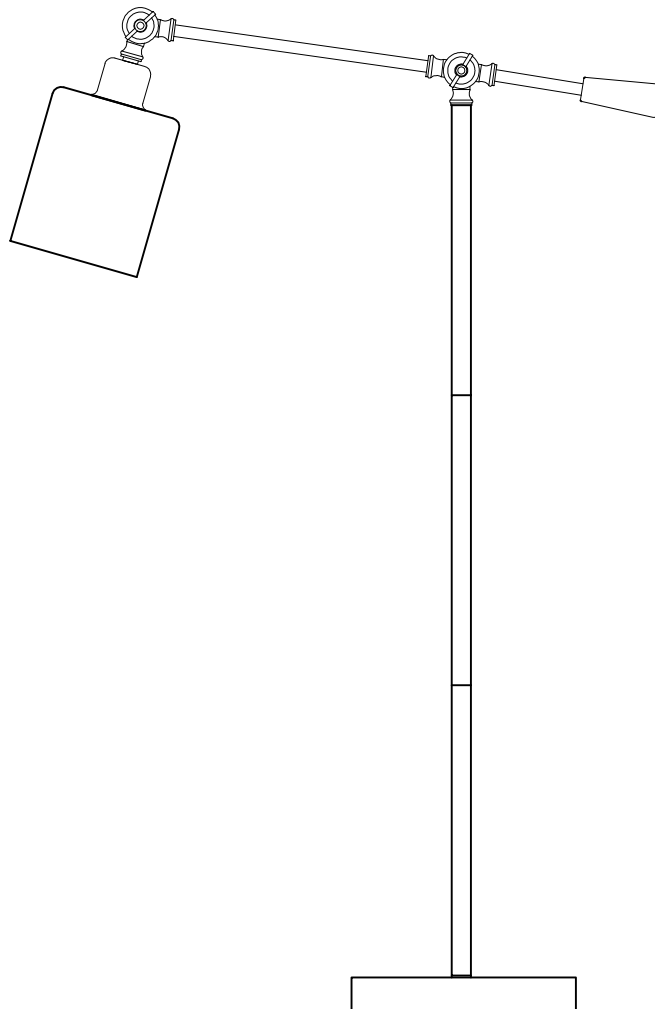

ALL • TOGETHER • BETTER

USE AND CARE GUIDE

THORNTON FLOOR LAMP-#32975



Questions, problems, missing parts? Before returning to the store,
call Kenroy Home Customer Service
8 a.m.-6 p.m., EST, Monday-Friday

904-642-4340

THANK YOU

We appreciate the trust and confidence you have placed in Kenroy Home through the purchase of this lamp.
We strive to continually create quality products designed to enhance your home.
Thank you for choosing us!

Table of Contents

Safety Information	2
Warranty	2
Pre-Installation	3
Planning Installation	3
Package Contents	3
Assembly	4, 5, 6
Care and Cleaning	7
Troubleshooting	7

Safety Information

Consult a qualified electrician with any electrical questions you may have.



IMPORTANT: Inspect the wire insulation for any cuts, abrasions, or exposed copper that may have occurred during shipping. If there is a defect in the wire, do not continue the assembly process. Please call our Customer Service Team at 904-642-4340.

Warranty

1-YEAR LIMITED WARRANTY

WHAT IS COVERED

The manufacturer warrants this lamp to be free from defects in the materials and workmanship for a period of one (1) year from date of purchase. This warranty applies only to the original consumer purchaser and only to products used in normal use. If this product is found to be defective, the manufacturer's only obligation, and your exclusive remedy, is the repair or replacement of the product at the manufacturer's discretion, provided that the product has not been damaged through misuse, abuse, accident, modifications, alterations, neglect or mishandling. This warranty shall not apply to any product that is found to have been improperly installed, assembled, or used in any way not in accordance with the instructions supplied with the product. This warranty shall not apply to a failure of the product as a result of an accident, misuse, abuse, negligence, alteration, faulty installation, or any other failure not relating to faulty material or workmanship.

WHAT IS NOT COVERED

This warranty shall not apply to the finish on any portion of the product due to weathering, as this is considered normal wear. The manufacturer does not warrant and specifically disclaims any warranty, whether expressed or implied, other than the warranty contained herein. The manufacturer specifically disclaims any liability and shall not be liable for any consequential or incidental loss or damage, including but not limited to, any labor or expense costs involved in the replacement or repair of the product.

Contact the Customer Service Team at 904-642-4340.

Pre-Installation

PLANNING INSTALLATION

Read all instructions before assembly.

To avoid damaging this product, assemble it on a soft, non-abrasive surface such as carpet or cardboard. Inspect each part for defects that may have occurred during shipping.

Keep your receipt and these instructions for proof of purchase.

 **NOTE:** This lamp requires the use of one 120V, 60Hz, 6-Watt Edison LED bulb (included) or one 120V, 60Hz, 60-Watt max, medium-base type A bulb (not included). Do not exceed the recommended wattage.

PACKAGE CONTENTS

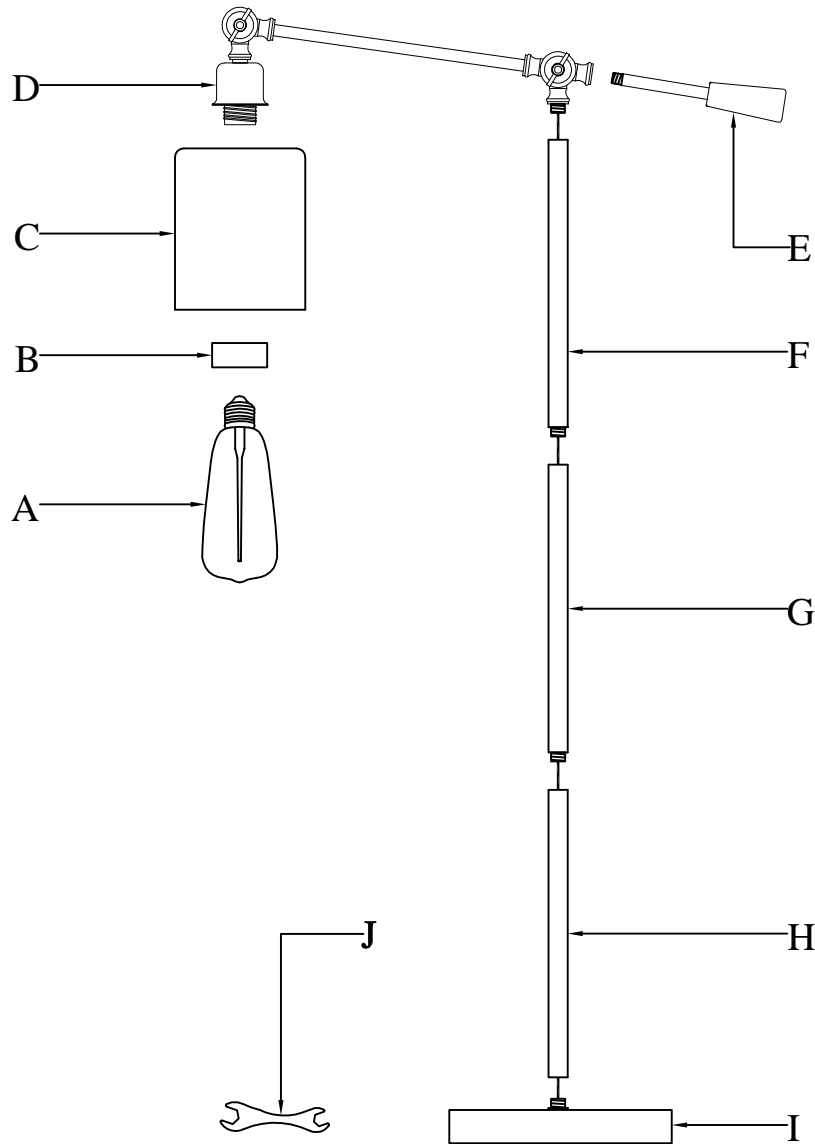

Part	Description	Quantity
A	LED bulb	1
B	Socket ring	1
C	Glass shade	1
D	Socket assembly	1
E	Handle	1

Part	Description	Quantity
F	Upper pole	1
G	Middle pole	1
H	Lower pole	1
I	Base	1
J	Wrench	1

Assembly instructions

1. Unpack the lamp and assemble handle

- Carefully organize and place all parts on a smooth, flat surface. line up all of the parts according to the assembly diagram.
- Screw the handle (E) to socket assembly (D).

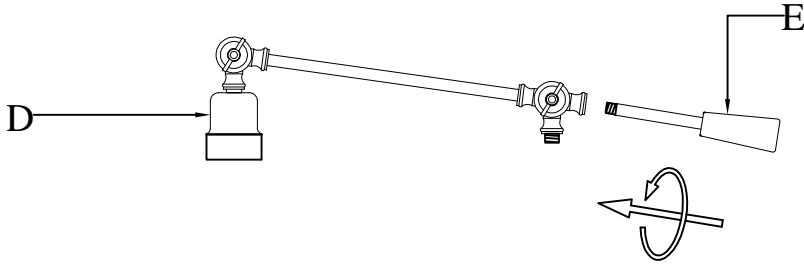

2. Assemble the poles

- Screw the lower pole (H) to top of the base (I).
- Screw the middle pole (G) to top of the lower pole (H).
- Screw the upper pole (F) to top of the middle pole (G).

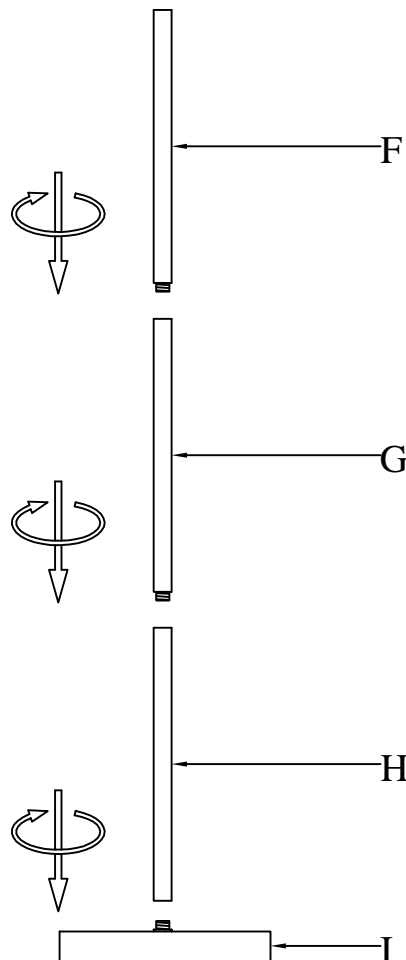

Assembly instructions (continued)

3. Assemble the socket assembly

- Pull the excess power cord through the base (I).
- Screw the socket assembly (D) to top of the upper pole (F).
- **NOTE:** Please make sure the arm (D) and socket face left as shown. If the arm and socket are not face left, adjust the arm and socket face left as shown and use the wrench (J) (included) to tighten the nut from bottom of the base (I).

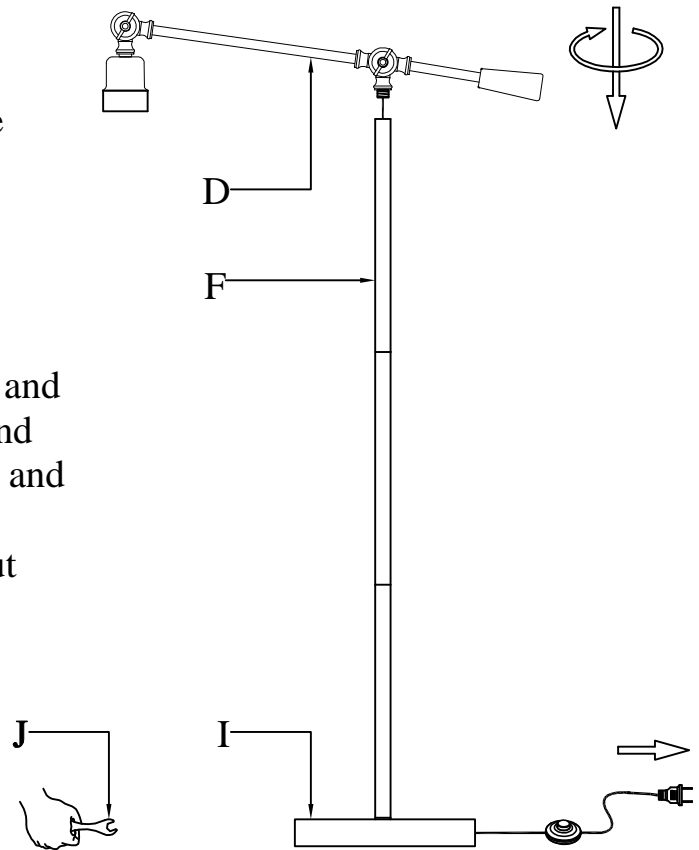

4. Assemble the glass shade

- Remove the socket ring (B) from the socket by unscrewing the socket ring (B).
- Place the glass shade (C) over the socket and secure with the socket ring (B).

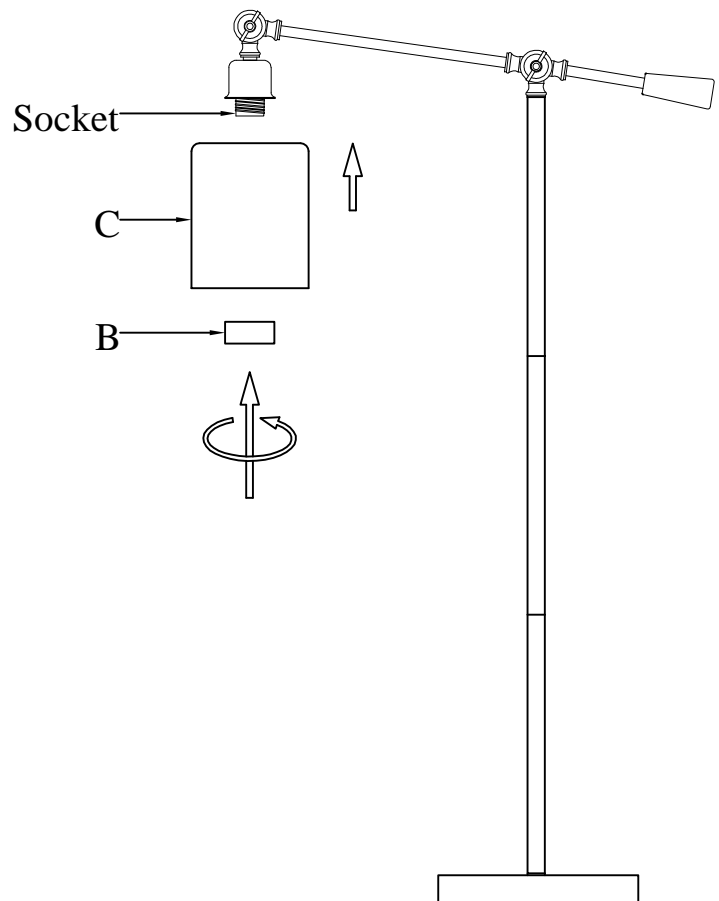

Assembly instructions (continued)

5. Assemble the bulb

- Prior to installing the bulb, inspect socket for silica packet. If packet is present, then remove and throw away. Do not expose it to children or pets.
- Install one 120V, 60Hz, 6-Watt Edison LED bulb (A) (included) or one 120V, 60Hz, 60-Watt max, medium-base type A bulb (not included) into the socket of the light lamp.
- You can adjust the position of shade by loosening the knobs.
- Plug cord into an outlet and turn on at the switch.

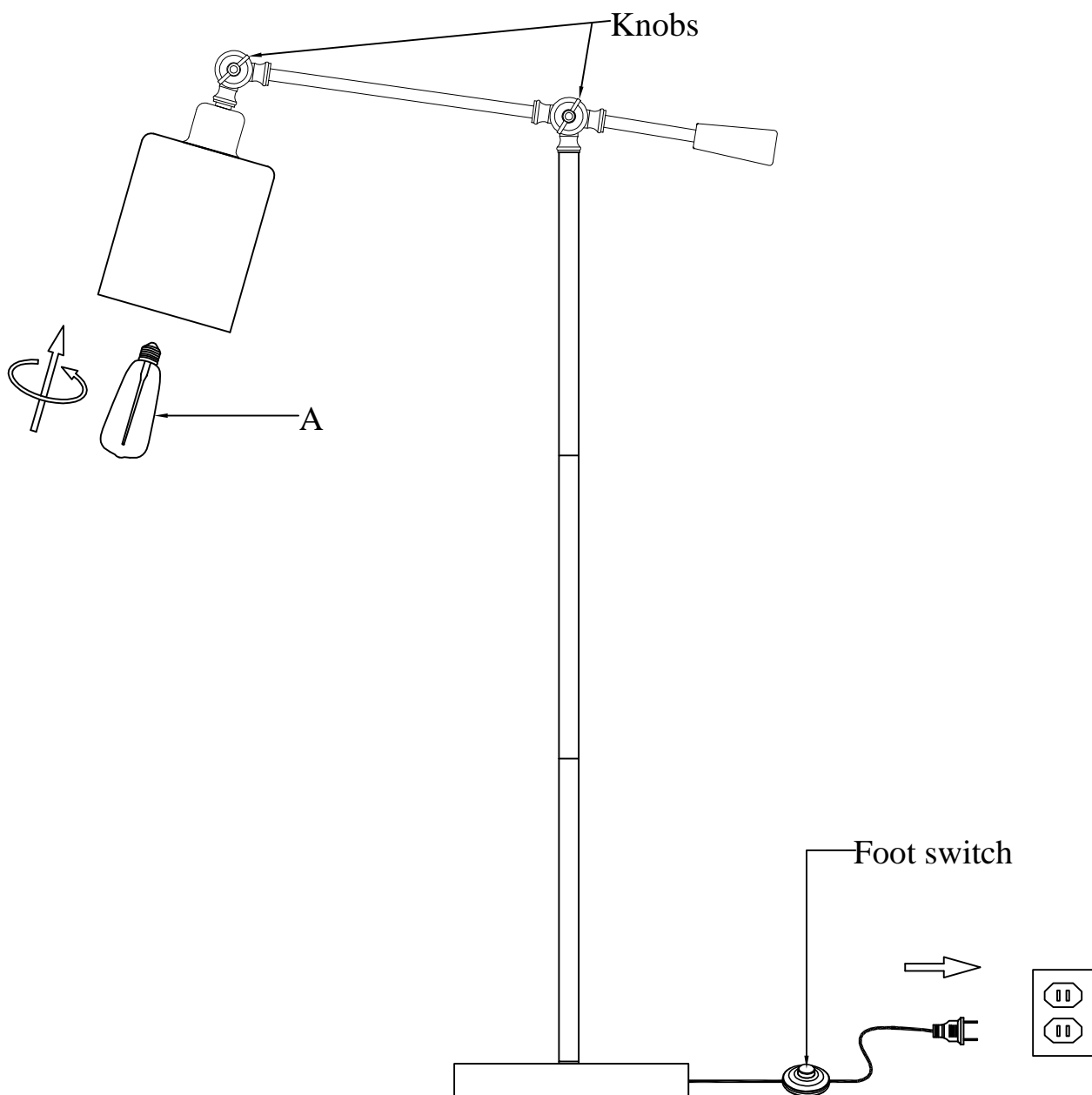

Warning: Changes or modifications to this unit not expressly approved by the party responsible for compliance could void the user's authority to operate the equipment.

NOTE: This equipment has been tested and found to comply with the limits for a Class B digital device, pursuant to Part 15 of the FCC Rules. These limits are designed to provide reasonable protection against harmful interference in a residential installation. This equipment generates, uses and can radiate radio frequency energy and, if not installed and used in accordance with the instructions, may cause harmful interference to radio communications. However, there is no guarantee that interference will not occur in a particular installation. If this equipment does cause harmful interference to radio or television reception, which can be determined by turning the equipment off and on, the user is encouraged to try to correct the interference by one or more of the following measures:

- Reorient or relocate the receiving antenna.
- Increase the separation between the equipment and receiver.
- Connect the equipment into an outlet on a circuit different from that to which the receiver is connected.
- Consult the dealer or an experienced radio/TV technician for help.

Important safety instructions

This portable lamp has a polarized plug (one blade is wider than the other) as a feature to reduce the risk of electric shock. This plug will fit in a polarized outlet only one way. If the plug does not fit fully in the outlet, reverse the plug. If it still does not fit, contact a qualified electrician. never use with an extension cord unless plug can be fully inserted. Do not alter the plug.

Care and Cleaning

Clean the lamp with a soft, dry cloth. Do not use any cleaners with chemicals, solvents, or harsh abrasives.

Troubleshooting

Problem	Possible Cause	Solution
The bulb will not light.	<input type="checkbox"/> The bulb is burned out.	<input type="checkbox"/> Replace the light bulb.
	<input type="checkbox"/> The power is off.	<input type="checkbox"/> Ensure that the power supply is turned on.
	<input type="checkbox"/> Did not insert plug into power outlet.	<input type="checkbox"/> Ensure that the plug is fully and properly inserted into the power outlet.
	<input type="checkbox"/> The circuit breaker is off.	<input type="checkbox"/> Ensure that the circuit breaker is set in the on position.
The fuse blows or a circuit breaker trips when the light is turned on.	<input type="checkbox"/> There is an exposed wire. <input type="checkbox"/> There are too many items on one circuit.	<input type="checkbox"/> Discontinue use of the lamp. <input type="checkbox"/> Contact a qualified electrician or call the Customer Service Team at 904-642-4340. <input type="checkbox"/> Unplug other items on the circuit.



ALL • TOGETHER • BETTER



www.kenroyhome.com

CUSTOMER SUPPORT TEAM

For any additional questions or concerns please contact our Customer Support Team:

 **904-642-4340**

 **@KenroyHome**

 **customerorders@kenroyhome.com**