



The All-New Oak™ Collection



SYMMONS

2025 Price Book



July 2025



SYMMONS

We Make Things Right™

Designs that optimize and revitalize, automate and invigorate, all integrated with the constant sustainability objectives of water and energy conservation.





We Make Things Right™

At Symmons, our promise to you is that we'll make things right. We'll always design and build our products with precision and the highest quality materials. Our Customer Service will make sure your experience is exceptional, and we'll always stand behind our products with the best warranties in the industry.



SYMMONS®

Pump Up the **Volume** with **HydroMersion**[®]

Showerheads and Hand Shower Wands Powered by HydroMersion!

HydroMersion Technology channels today's limited flow rates into best-in-class force, **making less water feel like more!**

Whether it's the full shoulder-to-shoulder relaxing coverage of the single-function, or the 7 unique modes of the multifunction, showerheads and hand shower wands with HydroMersion Technology deliver the ultimate shower experience.

All Symmons premium decorative collections feature HydroMersion showerheads and hand shower wands.

Single Function

Amplify your vibe. With full shoulder-to-shoulder coverage, the single-function showerheads and wands turn up the volume on your daily routine. The easy-to-clean EverFlow™ spray nozzles maximize flow for total relaxation.



7-Mode Multifunction

Dial in your attitude. From a relaxing mist on a warm summer day to a rejuvenating massage after a tough workout, multifunction showerheads and wands let you personalize the spray pattern to align with your mood.

Scan QR code to check out the sprays

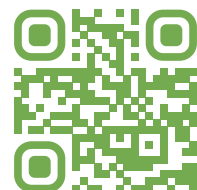

HydroMersion[®] Multifunction Sprays

1 Full
Immerse yourself in the full HydroMersion shower experience

Full mode brings an all-encompassing pattern of firm sprays to simultaneously invigorate and relax

2 Massage
Energize and revitalize your body and your outlook

Forceful pulses soothe sore muscles and joints to ease tension to speed recovery time

3 Dual
When you want the best of both worlds

Dual mode brings Full spray together with Massage for an awakening of body and mind

4 Center
Start the day relaxed, focused, and centered

Center mode aligns a series of concentrated streams to target neck and back muscles

5 Waterfall
Escape to a smooth, sweeping waterfall with just a click.

A semi-circular channel supplies a rich flow for a drenching cleanse

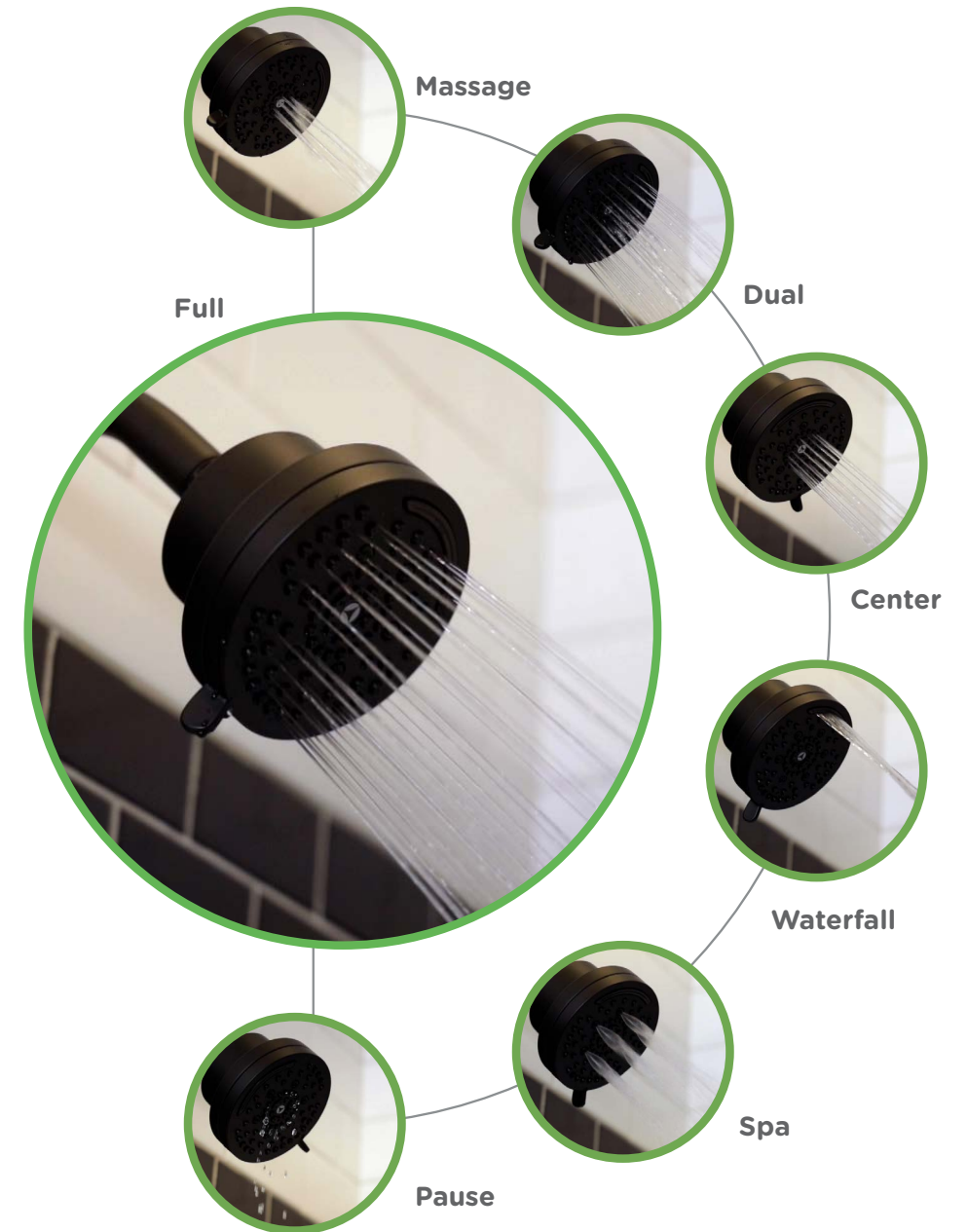

6 Spa
Treat yourself with own personal spa

Spa mode uses 6 large atomizing nozzles to create an invigorating and restorative shower experience

7 Pause
Take a break in Pause mode

Reduces flow to a trickle for safe showering and ADA compliance for hand shower

Design Style	CONTEMPORARY					TRANSITIONAL				TRADITIONAL	
Price	\$		\$ \$			\$		\$ \$		\$	\$ \$
Collection	Identity®	Solarity™	Verity™	Dia®	Duro®	Origins®	Birch™	Elm®	Oak™	Allura®	Braston™
Finishes											
Widespread											
Two-Handle Centerset											
Single-Handle											
Kitchen											
Tub Filler											
Shower											
Coordinating Accessories											

Temptrol® - The Perfect Balance

The leading pressure-balancing shower valve since 1968, made right here in the USA!

The solid brass control spindle and stainless-steel piston inside each Temptrol shower valve instantaneously balances water pressure for comfortable and safe showers every time.

Made right in the USA with brass and stainless steel, Temptrol valves have factory-installed options for the Rapid Install™ Bracket, Integral Stops, Reverse Seat, and a variety of connection fittings.

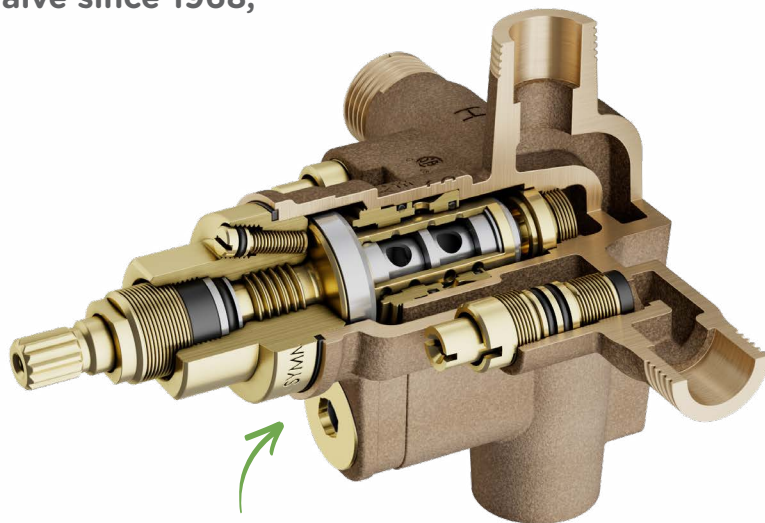

All brass, bronze, and stainless-steel!



CPVC



PEX Crimp



PEX CE



ProPress®



Retrim in Style

Temptrol valves are compatible with all Symmons decorative trims so you're always in style. They're the perfect balance of beauty, reliability, and safety.



Recharge the Warranty

If you rebuild a Temptrol with genuine Symmons parts, you'll automatically reset and renew that warranty—a full 10 years for commercial and lifetime for residential!

Temptrol VersaFlex™

The Temptrol VersaFlex valve is a version of the standard Temptrol valve that includes a lever right on the valve to control shower functions or water volume. It eliminates the need for a separate diverter, so installation is easier and less expensive!

There are two variations of the VersaFlex valve:

VersaFlex with Integral Diverter

Temptrol VersaFlex with Integral Diverter features a ceramic cartridge that lets you switch between any two functions, such as tub, shower, or hand shower.

VersaFlex with Volume Control

The lever on the Temptrol VersaFlex with Volume Control is used for shower-only installations. Use the lever to increase or reduce the volume of water while showering.



VersaFlex lever

Note: All VersaFlex valve SKUs include an "S" prefix. For example, **S262XBODY** (Integral Diverter) and **S261XBODY** (Volume Control).

When You Need **Quality**, Symmons has it!

Our goal is to make sure Symmons products are always available when you need them!

With our ReadyStock™ and Special Order tiers, you have clear visibility into product availability, so you can plan your projects confidently with reliable lead times.



ReadyStock™

ReadyStock products are always in stock and ready to ship within 3 days!

Just click the ReadyStock filter on the Search tool on [symmons.com](https://www.symmons.com)!



Scan the QR code to see all ReadyStock products!



Special Order

For projects with extended lead times of 18 weeks or more. (Minimum order quantities may apply.)

To check product availability or to place a special order, contact us by phone at **1-800-SYMMONS** or email us at csi@symmons.com.

Durability for Decades!

We have your back with the best warranties in the industry!

Our products stand the test of time, and we know a thing or two about longevity—we've been manufacturing the highest-quality plumbing products for the last **85 years**.

Symmons has the strongest warranty in the industry—**limited lifetime for residential and a full 10 years for commercial**. And our warranties are fully transferable!

And because we're so confident in our iconic Temptrol® valves when used in commercial locations, the 10-year warranty immediately renews and resets when you replace the TA-10 spindle and TA-4 seat kit with genuine Symmons replacement parts.

If you have an issue, our industry-leading Customer Service team will be there to stand behind our products and **make things right**.



The Right **Finish** for Your Project

When it all comes down to looks, Symmons offers five vibrant and durable finishes for all its products: Polished Chrome, Brushed Bronze, Matte Black, Satin Nickel, and Stainless Steel.



**Polished
Chrome**



**Brushed
Bronze
(BBZ)**



**Matte
Black
(MB)**



**Satin
Nickel
(STN)**



**Stainless
Steel
(STS)**

To push the envelope even more, **Design Studio™** can accommodate virtually any custom finish request you can imagine—metallic finishes, matte finishes, even pastels—to cast your unique project in a new light.

Imagination to **Creation**

Did you know Symmons has a team dedicated to designing and creating custom faucets, showers, bath accessories, and more for exclusive properties?

It's called **Symmons Design Studio™**, and the team's talents have helped create everything from graceful faucets for iconic hotels to mouse-shaped fixtures for the world's most famous theme park resorts.

If your project requires that extra-special something—large or small—the Design Studio team is here for you. Our cross-functional team of designers, engineers, and product specialists can bring your one-of-a-kind creative vision to life.

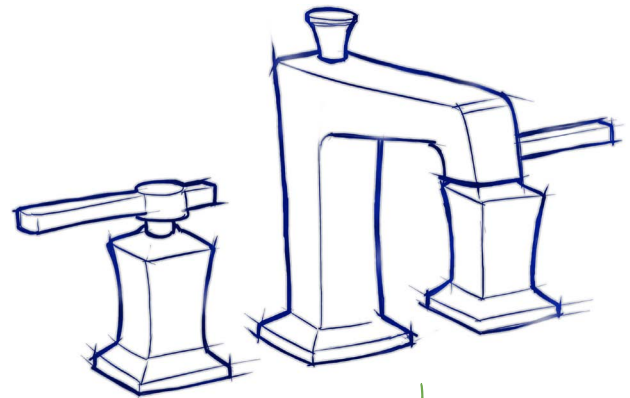

Scan the QR code to learn more about Design Studio

Widespread faucet design for the Bellagio® Hotel in Las Vegas

Contents

11	Allura® Collection
21	Birch™ Collection
31	Braston™ Collection
42	Dia® Collection
58	Duro® Collection
71	Elm® Collection
81	Identity® Collection
92	Oak™ Collection
102	Origins® Collection
118	Solarity™ Collection
128	Verity™ Collection
138	Tub/Shower Valve Bodies
159	Temptrol® Commercial Tub/Showers
162	SafetyMix® Tub/Showers
168	VisuTemp® Tub/Showers
174	LigRes® Showers
176	HydaPipe® Showers
182	ShowerOff® Metering Showers
187	Heavy Duty Faucets
192	ActivSense® Faucets & Soap Dispensers
202	SCOT®/Metering Faucets
206	MaxLine®

Contents Continued

212	TempControl®
217	LaundryMate®
219	Lavatory Faucets
234	Tub Faucets
236	Kitchen Faucets
241	Bar/Service/Laundry Faucets
243	Accessories
289	Repair Parts



Hey There!

Looking for the best shower systems, faucets, and bath accessories for your next project? Look no further! Symmons has representatives all across the US and Canada.



Scan the QR code to find a Symmons rep near you!

Allura® Collection

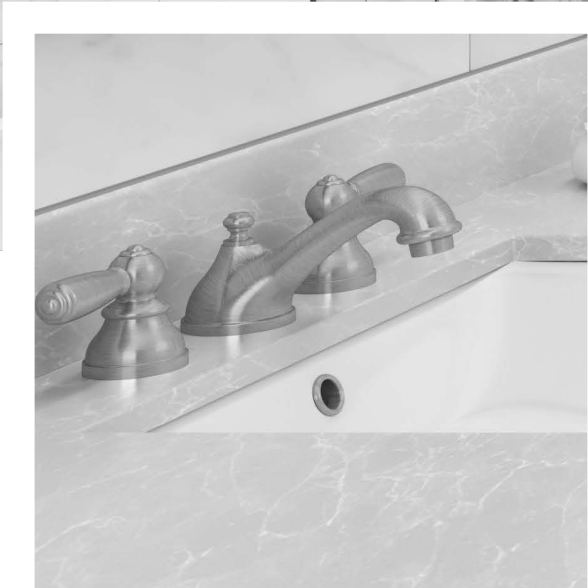

Traditional yet transitional, the Symmons Allura Collection blends classic detailing with modern accents and finishes. The solid construction and style give a distinct presence in any traditional bathroom.



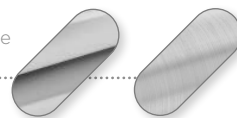

Available in these finishes:



Polished Chrome Satin Nickel
Radiance® PVD (STN)

Faucets • Tub/Showers • Accessories









Allura® Lavatory Faucets

	DESCRIPTION	MODEL	FINISH	PRICE
	<ul style="list-style-type: none"> Allura Widespread Lavatory Faucet 3-hole installation with 8-16" center Threadless valve-to-spout connections 3/8" braided hose connections Ceramic cartridges Metal push-pop drain assembly included 1.0 gpm (3.8 L/min) flow rate 	SLW4712PP	Chrome	741.20
		SLW4712STNPP	Satin Nickel	897.60
				
	<ul style="list-style-type: none"> Allura Centerset Lavatory Faucet 3-hole installation with 4" center 1/2" IPS connections Ceramic cartridges Solid brass construction Metal push-pop drain assembly included 1.0 gpm (3.8 L/min) flow rate 	SLC4712PP	Chrome	295.40
		SLC4712STNPP	Satin Nickel	416.25
				

Modifications for Allura Lavatory Faucets

SUFFIX	DESCRIPTION	CHROME	STN
05	 0.5 gpm (1.9 L/min) flow restrictor	N/C	N/C

Allura® Shower and Tub/Shower

	DESCRIPTION	MODEL	FINISH	PRICE
	<ul style="list-style-type: none"> Allura Shower Trim with VersaFlex Integral Diverter/Volume Control Metal handle 3-3/4" showerhead with 3 modes Red and blue indicators on escutcheon 2.0 gpm (7.6 L/min) flow rate 	<i>Trim Only: S26 Series Temptrol® valve required (see page 151)</i>		
		S-4701-TRM	Chrome	297.65
		S-4701-STN-TRM	Satin Nickel	443.50
		<i>Trim Only with flow control spindle and cap nut: S16 Series Temptrol® valve required (see page 151)</i>		
		S4701TRMTC	Chrome	375.15
		S4701STNTRMTC	Satin Nickel	521.00
P 				
	<ul style="list-style-type: none"> Allura shower system trim only Metal lever handle 3 mode showerhead 2.5 gpm (9.5 L/min) standard Tub spout not included 	<i>Trim Only: 26 Series Temptrol® valve required (see page 139)</i>		
		4701TRM	Chrome	274.65
		4701-STN-TRM	Satin Nickel	422.25
		<i>Trim Only with flow control spindle and cap nut: 16 Series Temptrol® valve required (see page 139)</i>		
		4701TRMTC	Chrome	352.15
		4701STNTRMTC	Satin Nickel	499.75
P 				
	<ul style="list-style-type: none"> Allura Tub and Shower Trim with VersaFlex Integral Diverter Metal handle 5-1/4" non-diverter tub spout 3-3/4" showerhead with 3 modes Red and blue indicators on escutcheon 2.0 gpm (7.6 L/min) flow rate 	<i>Trim Only: S26 Series Temptrol® valve required (see page 147)</i>		
		S-4702-TRM	Chrome	324.25
		S-4702-STN-TRM	Satin Nickel	478.15
		<i>Trim Only with flow control spindle and cap nut: S16 Series Temptrol® valve required (see page 147)</i>		
		S4702TRMTC	Chrome	401.75
		S4702STNTRMTC	Satin Nickel	555.65
P 				
	<ul style="list-style-type: none"> Allura Tub and Shower Trim Metal handle 5-1/2" diverter tub spout 3-3/4" showerhead with 3 modes Red and blue indicators on escutcheon 2.0 gpm (7.6 L/min) flow rate 	<i>Trim Only: 26 Series Temptrol® valve required (see page 139)</i>		
		4702-TRM	Chrome	301.15
		4702-STN-TRM	Satin Nickel	469.85
		<i>Trim Only with flow control spindle and cap nut: 16 Series Temptrol® valve required (see page 139)</i>		
		4702TRMTC	Chrome	378.65
		4702STNTRMTC	Satin Nickel	547.35
P 				
	<ul style="list-style-type: none"> Allura Hand Shower Trim Metal handle Cradle for hand shower 60" flexible metal hose 3-3/4" hand shower wand with 3 modes Red and blue indicators on escutcheon 2.0 gpm (7.6 L/min) flow rate 	<i>Trim Only: 26 Series Temptrol® valve required (see page 139)</i>		
		4703-TRM	Chrome	560.25
		4703-STN-TRM	Satin Nickel	942.85
		<i>Trim Only with flow control spindle and cap nut: 16 Series Temptrol® valve required (see page 139)</i>		
		4703TRMTC	Chrome	637.75
		4703STNTRMTC	Satin Nickel	1020.35
P				

Allura® Shower and Tub/Shower



DESCRIPTION

- Allura Tub and Hand Shower Trim with VersaFlex Integral Diverter
- Metal handle
- Cradle for hand shower
- 5-1/4" non-diverter tub spout
- 60" flexible metal hose
- 3-3/4" hand shower wand with 3 modes
- Red and blue indicators on escutcheon
- 2.0 gpm (7.6 L/min) flow rate

MODEL

FINISH

PRICE

Trim Only: S26 Series Temptrol® valve required (see page 147)

S-4704-TRM

Chrome

572.10

S-4704-STN-TRM

Satin Nickel

959.85

Trim Only with flow control spindle and cap nut: S16 Series Temptrol® valve required (see page 147)

S4704TRMTC

Chrome

649.60

S4704STNTRMTC

Satin Nickel

1037.35



- Allura Shower and Hand Shower Trim with VersaFlex Integral Diverter
- Metal handle
- Cradle for hand shower
- 60" flexible metal hose
- 3-3/4" hand shower wand with 3 modes
- 3-3/4" showerhead with 3 modes
- Red and blue indicators on escutcheon
- 2.0 gpm (7.6 L/min) flow rate

Trim Only: S26 Series Temptrol® valve required (see page 147)

S4708TRM

Chrome

562.50

S4708STNTRM

Satin Nickel

986.55

Trim Only with flow control spindle and cap nut: S16 Series Temptrol® valve required (see page 147)

S4708TRMTC

Chrome

640.00

S4708STNTRMTC

Satin Nickel

1064.05



- Allura Shower and Hand Shower Trim
- Metal lever handle
- Cradle for hand shower
- Separate dual outlet diverter trim
- 60" flexible metal hose
- 3-3/4" hand shower wand with 3 modes
- 3-3/4" showerhead with 3 modes
- Red and blue indicators on escutcheon
- 2.0 gpm (7.6 L/min) flow rate

Trim Only: 26 Series Temptrol® and 2DIV Series valves required (see pages 139 and 158)

4705-TRM

Chrome

856.10

4705-STN-TRM

Satin Nickel

1386.65

Trim Only with flow control spindle and cap nut: 16 Series Temptrol® and 2DIV Series valves required (see pages 139 and 158)

4705TRMTC

Chrome

933.60

4705STNTRMTC

Satin Nickel

1464.15



- Allura Shower System Trim
- Metal handle
- Cradle for hand shower
- Separate triple outlet diverter trim
- 5-1/4" non-diverter tub spout
- 60" flexible metal hose
- 3-3/4" hand shower wand with 3 modes
- 3-3/4" showerhead with 3 modes
- Red and blue indicators on escutcheon
- 2.0 gpm (7.6 L/min) flow rate

Trim Only: 26 Series Temptrol® and 3DIV Series valves required (see pages 139 and 158)

4706-TRM

Chrome

1006.05

4706-STN-TRM

Satin Nickel

1459.50

Trim Only with flow control spindle and cap nut: 16 Series Temptrol® and 3DIV Series valves required (see pages 139 and 158)

4706TRMTC

Chrome

1083.55





4706STNTRMTC

Satin Nickel

1537.00





Allura® Shower and Tub/Shower

	DESCRIPTION	MODEL	FINISH	PRICE
 <ul style="list-style-type: none"> Allura Shower Valve Trim with VersaFlex Integral Diverter/Volume Control Metal handle Red and blue indicators on escutcheon <p>P </p>	<i>Trim Only: S26 Series Temptrol® valve required (see pages 147 and 151)</i>			
		S-4700-TRM	Chrome	217.35
		S-4700-STN-TRM	Satin Nickel	327.95
	<i>Trim Only with flow control spindle and cap nut: S16 Series Temptrol® valve required (see pages 147 and 151)</i>			
		S4700TRMTC	Chrome	294.85
	S4700STNTRMTC	Satin Nickel	405.45	
 <ul style="list-style-type: none"> Allura Shower Valve Trim Metal handle Red and blue indicators on escutcheon <p>P </p>	<i>Trim Only: 26 Series Temptrol® valve required (see page 139)</i>			
		4700-TRM	Chrome	211.90
		4700-STN-TRM	Satin Nickel	317.25
	<i>Trim Only with flow control spindle and cap nut: 16 Series Temptrol® valve required (see page 139)</i>			
		4700TRMTC	Chrome	289.40
	4700STNTRMTC	Satin Nickel	394.75	

Modifications for Allura Shower and Tub/Shower Systems

SUFFIX	DESCRIPTION	CHROME	STN
15	1.5 gpm (5.7 L/min) flow restrictor	N/A	N/A
L1	Less showerhead	-67.70	-103.75
L2	Less hand shower	-45.20	-63.35
L3	Less showerhead and hand shower	-112.90	-167.05
L4	Less showerhead, arm and flange	-81.85	-122.15
L5	Less hand shower system	-167.85	-282.15
L6	Less tub spout (for non diverter tub spout, deduct this line)	-15.00	-23.90
L6.	Less tub spout (for diverter tub spout, deduct this line)	-33.60	-47.20
L7	Less handle	-28.75	-37.40

Allura® Shower and Tub/Shower Accessories

	DESCRIPTION	MODEL	FINISH	PRICE
	<ul style="list-style-type: none"> • Multifunction Showerhead • Standard on the Allura collection • 3-3/4" diameter • 3 modes • Easy to clean rubber nozzles 	2.0 gpm (7.6 L/min) standard		
		4-143	Chrome	147.50
		4-143-STN	Satin Nickel	226.25
		1.5 gpm (5.7 L/min) CALGreen		
		4-143-1.5	Chrome	147.50
		4-143-STN-1.5	Satin Nickel	226.25
	CG P			
	<ul style="list-style-type: none"> • Multifunction Hand Shower Wand • Standard on the Allura collection • 3-3/4" diameter • 3 modes • 2.0 gpm (7.6 L/min) flow rate 	EF-101	Chrome	104.65
		EF-101-STN	Satin Nickel	146.75
	P			
	<ul style="list-style-type: none"> • Multifunction Hand Shower System • Standard on the Allura collection • 3-3/4" hand shower wand with 3 modes • Cradle for hand shower wand mounting • 60" flexible metal hose • 2.0 gpm (7.6 L/min) flow rate 	H303-V	Chrome	400.80
		H303-V-STN	Satin Nickel	673.70
	P			
	<ul style="list-style-type: none"> • Multifunction Hand Shower System • Coordinates with Allura and Braston collections • 4" HydroMersion hand shower wand with 7 modes • EverFlow rubber spray nozzles • Integrated wall cradle and elbow • 60" flexible metal hose • Traditional style • 2.0 gpm (7.6 L/min) flow rate 	HR707	Chrome	440.10
		HR707STN	Satin Nickel	572.15
	WS P			

Allura® Shower and Tub/Shower Accessories

DESCRIPTION	MODEL	FINISH	PRICE
 <ul style="list-style-type: none"> • Multifunction Hand Shower Slide Bar System • Coordinates with Allura and Braston collections • 4" HydroMersion hand shower wand with 7 modes • EverFlow rubber spray nozzles • 30" hand shower slide bar • 60" flexible metal hose • Traditional style • 2.0 gpm (7.6 L/min) flow rate 	HR727	Chrome	530.10
	HR727STN	Satin Nickel	689.10

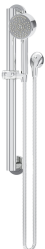

 <ul style="list-style-type: none"> • 24" or 36" Slide/Grab Bar • Contemporary/Modern style • 4" HydroMersion hand shower wand with 7 modes • EverFlow rubber spray nozzles • 60" flexible metal hose • 1-1/2" diameter slide bar • Pause mode for non-positive shutoff • ADA slide mechanism • Wall elbow included • 2.0 gpm (7.6 L/min) flow rate 	<i>24" Length</i>		
	H35924	Chrome	586.05
	H35924STN	Satin Nickel	770.25
	<i>36" Length</i>		
	H35936	Chrome	598.05
	H35936STN	Satin Nickel	787.05







 <ul style="list-style-type: none"> • Exposed Shower Riser • Round flanges • Metal lever handle • Diverter included for toggling between distinct showerhead and hand shower positions • Includes column/slide bar and hand shower bracket • 60" flexible metal hose • Hand shower and showerhead not included 	35EX	Chrome	718.55
	35EX-STN	Satin Nickel	1006.05



 <ul style="list-style-type: none"> • Short shower arm and flange • Stamped flange • 6" length 	300S	Chrome	26.85
	300S-STN	Satin Nickel	40.30









Allura® Shower and Tub/Shower Accessories

	DESCRIPTION	MODEL	FINISH	PRICE
	• Non-diverter tub spout	060	Chrome	32.70
	• 5-1/4" length	060-STN	Satin Nickel	49.60
	• Metal construction			
	• Thread-on installation			
	P			
	• Diverter tub spout	054	Chrome	73.50
	• 5-1/2" length	054-STN	Satin Nickel	106.15
	• Pull-up diverter			
	• Metal construction			
	• Thread-on installation			
	P			
	• Allura Diverter Valve Trim	<i>Trim Only: 2DIV-BODY or 3DIV-BODY required (see page 158)</i>		
	• 5" diameter	47-2DIV-TRM	Chrome	299.00
	• Screwless escutcheon	47-2DIV-STN-TRM	Satin Nickel	410.75
	• Dual or triple outlet			
	P 			

Modifications for Allura Shower and Tub/Shower Accessories

SUFFIX	DESCRIPTION	CHROME	STN
15	1.5 gpm (5.7 L/min) flow restrictor	N/A	N/A

	DESCRIPTION	MODEL	FINISH	PRICE	
	<ul style="list-style-type: none"> • 18" or 24" Towel Bar • Coordinates with Allura and Braston collections • Durable mounting system • Metal construction 	<i>18" Length</i>			
		583TB18	Chrome	100.45	
		583TB18STN	Satin Nickel	130.55	
		<i>24" Length</i>			
		583TB24	Chrome	110.20	
		583TB24STN	Satin Nickel	143.15	
P					
	<ul style="list-style-type: none"> • Robe Hook • Coordinates with Allura and Braston collections • Durable mounting system • Metal construction 	583RH	Chrome	32.50	
		583RHSTN	Satin Nickel	42.25	
		P			
	<ul style="list-style-type: none"> • Towel Ring • Coordinates with Allura and Braston collections • Durable mounting system • Metal construction 	583TR	Chrome	63.95	
		583TRSTN	Satin Nickel	83.25	
		P			
	<ul style="list-style-type: none"> • Toilet Paper Holder • Coordinates with Allura and Braston collections • Durable mounting system • Metal construction 	583TP	Chrome	61.65	
		583TPSTN	Satin Nickel	80.20	
		P			
	<ul style="list-style-type: none"> • Double Toilet Paper Holder • Coordinates with Allura and Braston collections • Durable mounting system • Metal construction • Matte Black finish is Special Order 	583DTP	Chrome	137.90	
		583DTPSTN	Satin Nickel	179.25	
		P			
	<ul style="list-style-type: none"> • Double Robe Hook • Coordinates with Allura and Braston collections • Durable mounting system • Metal construction • Matte Black finish is Special Order 	583DRH	Chrome	84.25	
		583DRHSTN	Satin Nickel	109.60	
		P			

Allura® Bath Accessories



DESCRIPTION	MODEL	FINISH	PRICE
<ul style="list-style-type: none"> • 24" or 36" Grab Bar • Coordinates with Allura and Braston collections • Metal construction • ADA compliant • Matte Black finish is Special Order 	<i>24" Length</i>		
	583GB24	Chrome	249.15
	583GB24STN	Satin Nickel	323.90
	<i>36" Length</i>		
	583GB36	Chrome	261.55
	583GB36STN	Satin Nickel	340.00



Birch™ Collection



The graceful curves, smooth circular elements, and modern touches of the Birch Collection combine to create a clean, comfortable Transitional aesthetic that feels both welcoming and refined.

Available in these finishes:

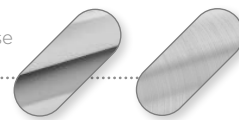







Polished Chrome Satin Nickel
Radiance® PVD
(STN)

Faucets • Tub/Showers • Accessories

Birch™ Lavatory Faucets

Birch™

	DESCRIPTION	MODEL	FINISH	PRICE
	<ul style="list-style-type: none"> • Birch Widespread Lavatory Faucet • 3-hole installation with 8-16" center • Threadless valve-to-spout connections • 3/8" braided hose connections • Ceramic cartridges • Metal push-pop drain assembly included • 1.0 gpm (3.8 L/min) flow rate 	SLW5912PP	Chrome	415.80
		SLW5912STNPP	Satin Nickel	540.50
				
	<ul style="list-style-type: none"> • Birch Single Handle Lavatory Faucet • Single-hole installation • 3/8" braided hose connections • Ceramic cartridges • Metal construction • Metal push-pop drain assembly included • 1.0 gpm (3.8 L/min) flow rate 	SLS5912PP	Chrome	330.40
		SLS5912STNPP	Satin Nickel	429.55
				
	<ul style="list-style-type: none"> • Birch Centerset Lavatory Faucet • 3-hole installation with 4" center • 1/2" IPS connections • Ceramic cartridges • Solid brass construction • Metal push-pop drain assembly included • 1.0 gpm (3.8 L/min) flow rate 	SLC5912PP	Chrome	286.55
		SLC5912STNPP	Satin Nickel	372.55
				

Modifications for Birch Lavatory Faucets

SUFFIX	DESCRIPTION	CHROME	STN
05	 0.5 gpm (1.9 L/min) flow restrictor	N/C	N/C

Birch™ Shower and Tub/Shower

DESCRIPTION	MODEL	FINISH	PRICE
 <ul style="list-style-type: none"> • Birch Shower Trim with VersaFlex Integral Diverter/Volume Control • 4" HydroMersion showerhead with Total spray • EverFlow rubber spray nozzles • VersaFlex Integral Diverter/Volume Control lever • Metal handle • 2.0 gpm (7.6 L/min) flow rate 	<i>Trim Only: S26 Series Temptrol® valve required (see page 151)</i>		
	S5991TRM	Chrome	293.30
	S5991STNTRM	Satin Nickel	381.30
	<i>Trim Only with flow control spindle and cap nut: S16 Series Temptrol® valve required (see page 151)</i>		
	S5991TRMTC	Chrome	370.80
	S5991STNTRMTC	Satin Nickel	458.80



 <ul style="list-style-type: none"> • Birch Shower Trim • 4" HydroMersion showerhead with Total spray • EverFlow rubber spray nozzles • Metal handle • 2.0 gpm (7.6 L/min) flow rate 	<i>Trim Only: 26 Series Temptrol® valve required (see page 139)</i>		
	5991TRM	Chrome	224.30
	5991STNTRM	Satin Nickel	291.50
	<i>Trim Only with flow control spindle and cap nut: 16 Series Temptrol® valve required (see page 139)</i>		
	5991TRMTC	Chrome	301.80
	5991STNTRMTC	Satin Nickel	369.00



 <ul style="list-style-type: none"> • Birch Tub and Shower Trim with VersaFlex Integral Diverter • 4" HydroMersion showerhead with Total spray • EverFlow rubber spray nozzles • VersaFlex Integral Diverter lever • 5-1/4" slip-on non-diverter tub spout • Metal handle • 2.0 gpm (7.6 L/min) flow rate 	<i>Trim Only: S26 Series Temptrol® valve required (see page 147)</i>		
	S5992TRM	Chrome	315.65
	S5992STNTRM	Satin Nickel	410.30
	<i>Trim Only with flow control spindle and cap nut: S16 Series Temptrol® valve required (see page 147)</i>		
	S5992TRMTC	Chrome	393.15
	S5992STNTRMTC	Satin Nickel	487.80



 <ul style="list-style-type: none"> • Birch Tub and Shower Trim • 4" HydroMersion showerhead with Total spray • EverFlow rubber spray nozzles • 5-1/4" slip-on diverter tub spout • Metal handle • 2.0 gpm (7.6 L/min) flow rate 	<i>Trim Only: 26 Series Temptrol® valve required (see page 139)</i>		
	5992TRM	Chrome	238.25
	5992STNTRM	Satin Nickel	309.75
	<i>Trim Only with flow control spindle and cap nut: 16 Series Temptrol® valve required (see page 139)</i>		
	5992TRMTC	Chrome	315.75
	5992STNTRMTC	Satin Nickel	387.25



Birch™ Shower and Tub/Shower



DESCRIPTION	MODEL	FINISH	PRICE
• Birch Hand Shower Trim	<i>Trim Only: 26 Series Temptrol® valve required (see page 139)</i>		
• 4" HydroMersion hand shower wand with Total spray and Pause mode	5993TRM	Chrome	555.10
	5993STNTRM	Satin Nickel	721.70
• EverFlow rubber spray nozzles	<i>Trim Only with flow control spindle and cap nut: 16 Series Temptrol® valve required (see page 139)</i>		
• 30" hand shower slide bar	5993TRMTC	Chrome	632.60
• 60" flexible metal hose	5993STNTRMTC	Satin Nickel	799.20
• Metal handle			
• 2.0 gpm (7.6 L/min) flow rate			







• Birch Tub and Hand Shower Trim with VersaFlex Integral Diverter	<i>Trim Only: S26 Series Temptrol® valve required (see page 147)</i>		
	S5994TRM	Chrome	633.55
• 4" HydroMersion hand shower wand with Total spray and Pause mode	S5994STNTRM	Satin Nickel	823.60
• EverFlow rubber spray nozzles	<i>Trim Only with flow control spindle and cap nut: S16 Series Temptrol® valve required (see page 147)</i>		
• VersaFlex Integral Diverter lever	S5994TRMTC	Chrome	711.05
• 5-1/4" slip-on non-diverter tub spout	S5994STNTRMTC	Satin Nickel	901.10
• 30" hand shower slide bar			
• 60" flexible metal hose			
• Metal handle			
• 2.0 gpm (7.6 L/min) flow rate			



• Birch Shower and Hand Shower Trim with VersaFlex Integral Diverter	<i>Trim Only: S26 Series Temptrol® valve required (see page 147)</i>		
	S5998TRM	Chrome	595.55
• 4" HydroMersion showerhead with Total spray	S5998STNTRM	Satin Nickel	774.15
• 4" HydroMersion hand shower wand with Total spray and Pause mode	<i>Trim Only with flow control spindle and cap nut: S16 Series Temptrol® valve required (see page 147)</i>		
	S5998TRMTC	Chrome	673.05
	S5998STNTRMTC	Satin Nickel	851.65
• EverFlow rubber spray nozzles			
• VersaFlex Integral Diverter lever			
• 30" hand shower slide bar			
• 60" flexible metal hose			
• Metal handle			
• 2.0 gpm (7.6 L/min) flow rate			



Birch™ Shower and Tub/Shower

DESCRIPTION	MODEL	FINISH	PRICE	
 <ul style="list-style-type: none"> • Birch Shower and Hand Shower Trim • 4" HydroMersion showerhead with Total spray • 4" HydroMersion hand shower wand with Total spray and Pause mode • Separate dual outlet diverter trim • EverFlow rubber spray nozzles • 30" hand shower slide bar • 60" flexible metal hose • Metal handle • 2.0 gpm (7.6 L/min) flow rate 	<i>Trim Only: 26 Series Temptrol® and 2DIV Series valves required (see pages 139 and 158)</i>			
	5995TRM	Chrome	765.75	
	5995STNTRM	Satin Nickel	995.45	
	<i>Trim Only with flow control spindle and cap nut: 16 Series Temptrol® and 2DIV Series valves required (see pages 139 and 158)</i>			
	5995TRMTC	Chrome	843.25	
	5995STNTRMTC	Satin Nickel	1072.95	
	WS P ♿			
	 <ul style="list-style-type: none"> • Birch Shower System Trim • 4" HydroMersion showerhead with Total spray • 4" HydroMersion hand shower wand with Total spray and Pause mode • EverFlow rubber spray nozzles • Separate triple outlet diverter trim • 30" hand shower slide bar • 60" flexible metal hose • 5-1/4" slip-on non-diverter tub spout • Metal handle • 2.0 gpm (7.6 L/min) flow rate 	<i>Trim Only: 26 Series Temptrol® and 3DIV Series valves required (see pages 139 and 158)</i>		
		5996TRM	Chrome	793.20
		5996STNTRM	Satin Nickel	1031.20
<i>Trim Only with flow control spindle and cap nut: 16 Series Temptrol® and 3DIV Series valves required (see pages 139 and 158)</i>				
5996TRMTC		Chrome	870.70	
5996STNTRMTC		Satin Nickel	1108.70	
WS P ♿				
 <ul style="list-style-type: none"> • Birch Shower Valve Trim with VersaFlex Integral Diverter/Volume Control • VersaFlex Integral Diverter/Volume Control lever • Metal handle 		<i>Trim Only: S26 Series Temptrol® valve required (see pages 147 and 151)</i>		
		S5990TRM	Chrome	238.15
		S5990STNTRM	Satin Nickel	309.60
	<i>Trim Only with flow control spindle and cap nut: S16 Series Temptrol® valve required (see pages 147 and 151)</i>			
	S5990TRMTC	Chrome	315.65	
	S5990STNTRMTC	Satin Nickel	387.10	
P ♿				
 <ul style="list-style-type: none"> • Birch Shower Valve Trim • Metal handle 	<i>Trim Only: 26 Series Temptrol® valve required (see page 139)</i>			
	5990TRM	Chrome	178.25	
	5990STNTRM	Satin Nickel	231.70	
	<i>Trim Only with flow control spindle and cap nut: 16 Series Temptrol® valve required (see page 139)</i>			
	5990TRMTC	Chrome	255.75	
	5990STNTRMTC	Satin Nickel	309.20	
P ♿				

Modifications for Birch Shower and Tub/Shower Systems

SUFFIX	DESCRIPTION	CHROME	STN
15	1.5 gpm (5.7 L/min) flow restrictor	N/A	N/A
L1	Less showerhead	-29.60	-38.50
L2	Less hand shower	-34.30	-44.60
L3	Less showerhead and hand shower	-63.90	-83.15
L4	Less showerhead, arm and flange	-43.80	-56.95
L5	Less hand shower system	-212.00	-275.60
L6	Less tub spout (for non diverter tub spouts, deduct this line)	-30.45	-39.55
L6.	Less tub spout (for diverter tub spouts, deduct this line)	-46.70	-60.65
L7	Less handle	-25.75	-33.45

Birch™ Shower and Tub/Shower Accessories

DESCRIPTION	MODEL	FINISH	PRICE
 <ul style="list-style-type: none"> • Single-Function Showerhead • Standard on the Birch collection • 4" diameter • HydroMersion technology for increased force • Total spray for complete coverage • EverFlow rubber spray nozzles • Solid brass ball joint • Transitional style 	<i>2.0 gpm (7.6 L/min) standard</i>		
	592SH	Chrome	74.05
	592SHSTN	Satin Nickel	96.30
	<i>1.5 gpm (5.7 L/min) WaterSense®, CALGreen</i>		
	592SH15	Chrome	74.05
	592SHSTN15	Satin Nickel	96.30



 <ul style="list-style-type: none"> • Single-Function Hand Shower Wand • Standard on the Birch collection • 4" diameter • HydroMersion technology for increased force • Total spray for complete coverage • Pause mode for non-positive shutoff • Easy-shift thumb lever • EverFlow rubber spray nozzles • Transitional style 	<i>2.0 gpm (7.6 L/min) standard</i>		
	592W	Chrome	85.75
	592WSTN	Satin Nickel	111.45
	<i>1.5 gpm (5.7 L/min) WaterSense®, CALGreen</i>		
	592W15	Chrome	85.75
	592WSTN15	Satin Nickel	111.45



 <ul style="list-style-type: none"> • Single-Function Hand Shower System • Coordinates with the Birch collection • 4" HydroMersion hand shower wand with Total spray and Pause mode • EverFlow rubber spray nozzles • Wall cradle and elbow • 60" flexible metal hose • Transitional style • 2.0 gpm (7.6 L/min) flow rate 	HR601	Chrome	440.10
	HR601STN	Satin Nickel	572.15



 <ul style="list-style-type: none"> • Single-Function Hand Shower Slide Bar System • Coordinates with the Birch collection • 4" HydroMersion hand shower wand with Total spray and Pause mode • EverFlow rubber spray nozzles • 30" hand shower slide bar • 60" flexible metal hose • Transitional style • 2.0 gpm (7.6 L/min) flow rate 	HR621	Chrome	530.10
	HR621STN	Satin Nickel	689.10







Birch™ Shower and Tub/Shower Accessories

	DESCRIPTION	MODEL	FINISH	PRICE	
	<ul style="list-style-type: none"> • 24" or 36" Slide/Grab Bar • Contemporary/Modern style • 4" HydroMersion hand shower wand with 7 modes 	<i>24" Length</i> H35924 H35924STN	Chrome Satin Nickel	586.05 770.25	
	<ul style="list-style-type: none"> • EverFlow rubber spray nozzles • 60" flexible metal hose • 1-1/2" diameter slide bar • Pause mode for non-positive shutoff • ADA slide mechanism • Wall elbow included • 2.0 gpm (7.6 L/min) flow rate 	H35936 H35936STN	Chrome Satin Nickel	598.05 787.05	
	<p>WS P </p>				
		<ul style="list-style-type: none"> • Shower arm with heavy flange • 8" length 	300 300-STN	Chrome Satin Nickel	83.00 107.50
		<p>P</p>			
		<ul style="list-style-type: none"> • Non-diverter tub spout • 5-1/4" length • Metal construction • Slip-on installation 	061 061-STN	Chrome Satin Nickel	57.40 93.95
		<p>P</p>			
	<ul style="list-style-type: none"> • Diverter tub spout • 5-1/2" length • 1/2" inlet • Pull-up diverter • Metal construction • Slip-on installation 	053 053-STN	Chrome Satin Nickel	87.75 142.25	
	<p>P </p>				
	<ul style="list-style-type: none"> • Birch Diverter Valve Trim • 5" diameter • Metal handle • Screwless escutcheon • Dual or triple outlet 	<i>Trim Only: 2DIV-BODY or 3DIV-BODY required (see page 158)</i> 59DIVTRM 59DIVSTNTRM	Chrome Satin Nickel	232.15 301.80	
	<p>P </p>				

Modifications for Birch Shower and Tub/Shower Accessories

SUFFIX	DESCRIPTION	CHROME	STN
15	1.5 gpm (5.7 L/min) flow restrictor	N/A	N/A

Birch™ Bath Accessories

	DESCRIPTION	MODEL	FINISH	PRICE
	<ul style="list-style-type: none"> • 18" or 24" Towel Bar • Coordinates with Birch and Elm collections 	<i>18" Length</i>		
		553TB-18	Chrome	86.70
	<ul style="list-style-type: none"> • Durable mounting system • Metal construction 	<i>24" Length</i>		
		553TB-18-STN	Satin Nickel	125.55
		553TB-24	Chrome	95.20
		553TB-24-STN	Satin Nickel	137.90
P				
	<ul style="list-style-type: none"> • Double Robe Hook • Coordinates with Birch and Elm collections 	553RH	Chrome	46.40
		553RH-STN	Satin Nickel	67.05
	<ul style="list-style-type: none"> • Durable mounting system • Metal construction 	P		
		553TR	Chrome	57.95
	<ul style="list-style-type: none"> • Towel Ring • Coordinates with Birch and Elm collections 	553TR-STN	Satin Nickel	84.05
		P		
	<ul style="list-style-type: none"> • Toilet Paper Holder • Coordinates with Birch and Elm collections 	553TP	Chrome	95.20
		553TP-STN	Satin Nickel	137.90
<ul style="list-style-type: none"> • Durable mounting system • Metal construction 	P			
	P			

Braston™ Collection



Braston™

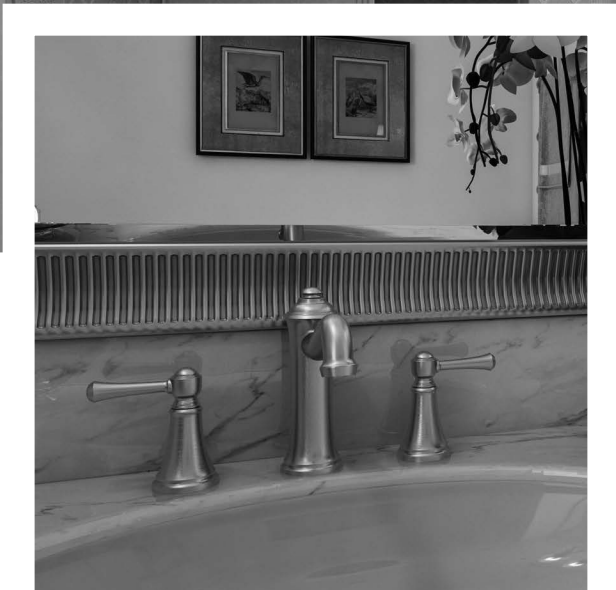

Braston is the latest Traditional decorative collection from Symmons. With classic curves and a refined aesthetic, Braston blends traditional designs with modern amenities for timeless elegance.

Available in these finishes:

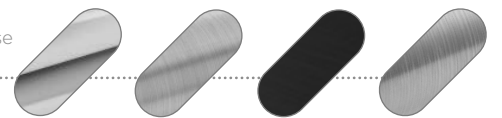

Polished Chrome Satin Nickel Radiance® PVD (STN) Matte Black (MB) Brushed Bronze Radiance® PVD (BBZ)

Faucets • Tub/Showers • Accessories

Braston™ Lavatory Faucets and Tub Filler



DESCRIPTION	MODEL	FINISH	PRICE
• Braston Widespread Lavatory Faucet	SLW5812PP	Chrome	657.35
• 3-hole installation with 8-16" center	SLW5812STNPP	Satin Nickel	854.55
• Threadless valve-to-spout connections	SLW5812MBPP	Matte Black	920.25
• 3/8" braided hose connections	SLW5812BBZPP	Brushed Bronze	920.25
• Ceramic cartridges			
• Metal construction			
• Metal push-pop drain assembly included			
• 1.0 gpm (3.8 L/min) flow rate			



• Braston Single Handle Lavatory Faucet	SLS5812PP	Chrome	432.40
• Single-hole installation	SLS5812STNPP	Satin Nickel	562.05
• 3/8" braided hose connections	SLS5812MBPP	Matte Black	605.35
• Ceramic cartridges	SLS5812BBZPP	Brushed Bronze	605.35
• Metal construction			
• Metal push-pop drain assembly included			
• 1.0 gpm (3.8 L/min) flow rate			
• Matte Black finish is Special Order			



DESCRIPTION	MODEL	FINISH	PRICE
• Braston Freestanding Tub Filler			
• Floor-mounted tub filler with single-handle temperature control	FSTF5872	Chrome	2269.10
	FSTF5872STN	Satin Nickel	2949.85
• 4" HydroMersion hand shower wand with 7 modes	FSTF5872MB	Matte Black	3176.70
	FSTF5872BBZ	Brushed Bronze	3176.70
• EverFlow rubber spray nozzles			
• 60" flexible metal hose			
• Metal lever handle			
• 2.0 gpm (7.6 L/min) flow rate hand shower			
• 5.3 gpm (20.1 L/min) at 45 psi tub filler			
• Matte Black finish is Special Order			









If tempering valve is required, use MaxLine® 7-230 Series (page 208)



Modifications for Braston Lavatory Faucets and Tub Filler

SUFFIX	DESCRIPTION	CHROME	STN	BBZ	MB
05	CG 0.5 gpm (1.9 L/min) flow restrictor	N/A	N/A	N/A	N/A
L2	Less hand shower wand	-45.20	-58.70	-63.25	-63.25

Braston™ Shower and Tub/Shower

	DESCRIPTION	MODEL	FINISH	PRICE
	<ul style="list-style-type: none"> • Braston Shower Trim with VersaFlex Integral Diverter/Volume Control • 4" HydroMersion showerhead with 7 modes • EverFlow rubber spray nozzles • VersaFlex Integral Diverter/Volume Control lever • Metal handle • 2.0 gpm (7.6 L/min) flow rate • Matte Black finish is Special Order 	<i>Trim Only: S26 Series Temptrol® valve required (see page 151)</i>		
		S5891TRM	Chrome	455.55
		S5891STNTRM	Satin Nickel	592.25
		S5891MBTRM	Matte Black	637.75
		S5891BBZTRM	Brushed Bronze	637.75
		<i>Trim Only with flow control spindle and cap nut: S16 Series Temptrol® valve required (see page 151)</i>		
		S5891TRMTC	Chrome	533.05
		S5891STNTRMTC	Satin Nickel	669.75
		S5891MBTRMTC	Matte Black	715.25
		S5891BBZTRMTC	Brushed Bronze	715.25
<p>WS P </p>				
	<ul style="list-style-type: none"> • Braston Shower Trim • 4" HydroMersion showerhead with 7 modes • EverFlow rubber spray nozzles • Metal handle • 2.0 gpm (7.6 L/min) flow rate • Matte Black finish is Special Order 	<i>Trim Only: 26 Series Temptrol® valve required (see page 139)</i>		
		5891TRM	Chrome	425.95
		5891STNTRM	Satin Nickel	553.70
		5891MBTRM	Matte Black	596.30
		5891BBZTRM	Brushed Bronze	596.30
		<i>Trim Only with flow control spindle and cap nut: 16 Series Temptrol® valve required (see page 139)</i>		
		5891TRMTC	Chrome	503.45
		5891STNTRMTC	Satin Nickel	631.20
		5891MBTRMTC	Matte Black	673.80
		5891BBZTRMTC	Brushed Bronze	673.80
<p>WS P </p>				
	<ul style="list-style-type: none"> • Braston Tub and Shower Trim with VersaFlex Integral Diverter • 4" HydroMersion showerhead with 7 modes • EverFlow rubber spray nozzles • VersaFlex Integral Diverter lever • 7-1/16" slip-on non-diverter tub spout • Metal handle • 2.0 gpm (7.6 L/min) flow rate • Matte Black finish is Special Order 	<i>Trim Only: S26 Series Temptrol® valve required (see page 147)</i>		
		S5892TRM	Chrome	495.30
		S5892STNTRM	Satin Nickel	643.85
		S5892MBTRM	Matte Black	693.35
		S5892BBZTRM	Brushed Bronze	693.35
		<i>Trim Only with flow control spindle and cap nut: S16 Series Temptrol® valve required (see page 147)</i>		
		S5892TRMTC	Chrome	572.80
		S5892STNTRMTC	Satin Nickel	721.35
		S5892MBTRMTC	Matte Black	770.85
		S5892BBZTRMTC	Brushed Bronze	770.85
<p>WS P </p>				
	<ul style="list-style-type: none"> • Braston Tub and Shower Trim • 4" HydroMersion showerhead with 7 modes • EverFlow rubber spray nozzles • 7-1/16" slip-on diverter tub spout • Metal handle • 2.0 gpm (7.6 L/min) flow rate • Matte Black finish is Special Order 	<i>Trim Only: 26 Series Temptrol valve required (see pages 139)</i>		
		5892TRM	Chrome	488.25
		5892STNTRM	Satin Nickel	634.75
		5892MBTRM	Matte Black	683.60
		5892BBZTRM	Brushed Bronze	683.60
		<i>Trim Only with flow control spindle and cap nut: 16 Series Temptrol® valve required (see page 139)</i>		
		5892TRMTC	Chrome	565.75
		5892STNTRMTC	Satin Nickel	712.25
		5892MBTRMTC	Matte Black	761.10
		5892BBZTRMTC	Brushed Bronze	761.10
<p>WS P </p>				

Braston™ Shower and Tub/Shower



DESCRIPTION	MODEL	FINISH	PRICE
• Braston Hand Shower Trim	<i>Trim Only: 26 Series Temptrol® valve required (see page 139)</i>		
• 4" HydroMersion hand shower wand with 7 modes	5893TRM	Chrome	912.65
	5893STNTRM	Satin Nickel	1186.50
• EverFlow rubber spray nozzles	5893MBTRM	Matte Black	1277.70
• 30" hand shower slide bar	5893BBZTRM	Brushed Bronze	1277.70
• 60" flexible metal hose	<i>Trim Only with flow control spindle and cap nut: 16 Series Temptrol® valve required (see page 139)</i>		
• Metal handle	5893TRMTC	Chrome	990.15
• 2.0 gpm (7.6 L/min) flow rate	5893STNTRMTC	Satin Nickel	1264.00
• Matte Black finish is Special Order	5893MBTRMTC	Matte Black	1355.20
	5893BBZTRMTC	Brushed Bronze	1355.20



• Braston Tub and Hand Shower Trim with VersaFlex Integral Diverter	<i>Trim Only: S26 Series Temptrol® valve required (see page 147)</i>		
	S5894TRM	Chrome	952.70
• 4" HydroMersion hand shower wand with 7 modes	S5894STNTRM	Satin Nickel	1238.55
	S5894MBTRM	Matte Black	1333.85
• EverFlow rubber spray nozzles	S5894BBZTRM	Brushed Bronze	1333.85
• VersaFlex Integral Diverter lever	<i>Trim Only with flow control spindle and cap nut: S16 Series Temptrol® valve required (see page 147)</i>		
• 7-1/16" slip-on non-diverter tub spout	S5894TRMTC	Chrome	1030.20
• 30" hand shower slide bar	S5894STNTRMTC	Satin Nickel	1316.05
• 60" flexible metal hose	S5894MBTRMTC	Matte Black	1411.35
• Metal handle	S5894BBZTRMTC	Brushed Bronze	1411.35
• 2.0 gpm (7.6 L/min) flow rate			
• Matte Black finish is Special Order			



• Braston Shower and Hand Shower Trim with VersaFlex Integral Diverter	<i>Trim Only: S26 Series Temptrol® valve required (see page 147)</i>		
	S5898TRM	Chrome	913.35
• 4" multifunction showerhead and hand shower wand with 7 modes	S5898STNTRM	Satin Nickel	1187.35
	S5898MBTRM	Matte Black	1278.70
• EverFlow rubber spray nozzles	S5898BBZTRM	Brushed Bronze	1278.70
• VersaFlex Integral Diverter lever	<i>Trim Only with flow control spindle and cap nut: S16 Series Temptrol® valve required (see page 147)</i>		
• 30" hand shower slide bar	S5898TRMTC	Chrome	990.85
• 60" flexible metal hose	S5898STNTRMTC	Satin Nickel	1264.85
• Metal handle	S5898MBTRMTC	Matte Black	1356.20
• 2.0 gpm (7.6 L/min) flow rate	S5898BBZTRMTC	Brushed Bronze	1356.20
• Matte Black finish is Special Order			



Braston™ Shower and Tub/Shower

DESCRIPTION	MODEL	FINISH	PRICE
 <ul style="list-style-type: none"> • Braston Shower and Hand Shower Trim • 4" HydroMersion showerhead and hand shower wand with 7 modes • EverFlow rubber spray nozzles • Separate dual outlet diverter trim • 30" hand shower slide bar • 60" flexible metal hose • Metal handle • 2.0 gpm (7.6 L/min) flow rate • Matte Black finish is Special Order 	<i>Trim Only: 26 Series Temptrol® and 2DIV Series valves required (see pages 139 and 158)</i>		
	5895TRM	Chrome	1243.80
	5895STNTRM	Satin Nickel	1616.95
	5895MBTRM	Matte Black	1741.25
	5895BBZTRM	Brushed Bronze	1741.25
	<i>Trim Only with flow control spindle and cap nut: 16 Series Temptrol® and 2DIV Series valves required (see pages 139 and 158)</i>		
	5895TRMTC	Chrome	1321.30
	5895STNTRMTC	Satin Nickel	1694.45
	5895MBTRMTC	Matte Black	1818.75
	5895BBZTRMTC	Brushed Bronze	1818.75



 <ul style="list-style-type: none"> • Braston Shower System Trim • 4" HydroMersion showerhead and hand shower wand with 7 modes • EverFlow rubber spray nozzles • Separate triple outlet diverter trim • 30" hand shower slide bar • 60" flexible metal hose • 7-1/16" slip-on non-diverter tub spout • Metal handle • 2.0 gpm (7.6 L/min) flow rate • Matte Black finish is Special Order 	<i>Trim Only: 26 Series Temptrol® and 3DIV Series valves required (see pages 139 and 158)</i>		
	5896TRM	Chrome	1308.40
	5896STNTRM	Satin Nickel	1700.90
	5896MBTRM	Matte Black	1831.70
	5896BBZTRM	Brushed Bronze	1831.70
	<i>Trim Only with flow control spindle and cap nut: 16 Series Temptrol® and 3DIV Series valves required (see pages 139 and 158)</i>		
	5896TRMTC	Chrome	1385.90
	5896STNTRMTC	Satin Nickel	1778.40
	5896MBTRMTC	Matte Black	1909.20
	5896BBZTRMTC	Brushed Bronze	1909.20



 <ul style="list-style-type: none"> • Braston Shower Valve Trim with VersaFlex Integral Diverter/Volume Control • VersaFlex Integral Diverter/Volume Control lever • Metal handle • Matte Black finish is Special Order 	<i>Trim Only: S26 Series Temptrol® valve required (see page 147 and 151)</i>		
	S5890TRM	Chrome	336.65
	S5890STNTRM	Satin Nickel	437.60
	S5890MBTRM	Matte Black	471.30
	S5890BBZTRM	Brushed Bronze	471.30
	<i>Trim Only with flow control spindle and cap nut: S16 Series Temptrol® valve required (see pages 147 and 151)</i>		
S5890TRMTC	Chrome	414.15	
S5890STNTRMTC	Satin Nickel	515.10	
S5890MBTRMTC	Matte Black	548.80	
S5890BBZTRMTC	Brushed Bronze	548.80	



 <ul style="list-style-type: none"> • Braston Shower Valve Trim • Metal handle • Matte Black finish is Special Order 	<i>Trim Only: 26 Series Temptrol® valve required (see page 139)</i>		
	5890TRM	Chrome	317.85
	5890STNTRM	Satin Nickel	413.20
	5890MBTRM	Matte Black	445.00
	5890BBZTRM	Brushed Bronze	445.00
	<i>Trim Only with flow control spindle and cap nut: 16 Series Temptrol® valve required (see page 139)</i>		
	5890TRMTC	Chrome	395.35
	5890STNTRMTC	Satin Nickel	490.70
5890MBTRMTC	Matte Black	522.50	
5890BBZTRMTC	Brushed Bronze	522.50	



Modifications for Braston Shower and Tub/Shower Systems

SUFFIX	DESCRIPTION	CHROME	STN	BBZ	MB
15	1.5 gpm (5.7 L/min) flow restrictor	N/A	N/A	N/A	N/A
L1	Less showerhead	-43.60	-56.80	-61.05	-61.05
L2	Less hand shower	-45.20	-58.70	-63.25	-63.25
L3	Less showerhead and hand shower	-88.80	-115.45	-124.30	-124.30
L4	Less showerhead, arm and flange	-82.95	-107.90	-116.15	-116.15
L5	Less hand shower system	-212.00	-275.60	-296.80	-296.80
L6	Less tub spout	-29.40	-41.30	-42.80	-42.80
L7	Less handle	-51.35	-66.60	-71.85	71.85

Braston™ Shower and Tub/Shower Accessories

DESCRIPTION	MODEL	FINISH	PRICE
 <ul style="list-style-type: none"> • Multifunction Showerhead • Standard on the Braston collection • 4" diameter • 7 modes • HydroMersion technology for increased force • EverFlow rubber spray nozzles • Easy-shift thumb lever • Solid brass ball joint • Traditional style 	<i>2.0 gpm (7.6 L/min) standard</i>		
	582SH7	Chrome	109.05
	582SH7STN	Satin Nickel	141.75
	582SH7MB	Matte Black	153.70
	582SH7BBZ	Brushed Bronze	153.70
	<i>1.5 gpm (5.7 L/min) CALGreen</i>		
	582SH715	Chrome	109.05
	582SH7STN15	Satin Nickel	141.75
	582SH7MB15	Matte Black	153.70
	582SH7BBZ15	Brushed Bronze	153.70



 <ul style="list-style-type: none"> • Single-Function Showerhead • 4" diameter • HydroMersion technology for increased force • Total spray for complete coverage • EverFlow rubber spray nozzles • Solid brass ball joint • Traditional style 	<i>2.0 gpm (7.6 L/min) standard</i>		
	582SH	Chrome	74.05
	582SHSTN	Satin Nickel	96.30
	582SHMB	Matte Black	103.60
	582SHBBZ	Brushed Bronze	103.60
	<i>1.5 gpm (5.7 L/min) CALGreen</i>		
	582SH15	Chrome	74.05
	582SHSTN15	Satin Nickel	96.30
	582SHMB15	Matte Black	103.60
	582SHBBZ15	Brushed Bronze	103.60



 <ul style="list-style-type: none"> • Multifunction Hand Shower Wand • Standard on the Braston collection • 4" diameter • 7 modes • HydroMersion technology for increased force • EverFlow rubber spray nozzles • Easy-shift thumb lever • Pause mode for non-positive shutoff • Traditional style 	<i>2.0 gpm (7.6 L/min) standard</i>		
	582W7	Chrome	112.90
	582W7STN	Satin Nickel	146.80
	582W7MB	Matte Black	158.05
	582W7BBZ	Brushed Bronze	158.05
	<i>1.5 gpm (5.7 L/min) CALGreen</i>		
	582W715	Chrome	112.90
	582W7STN15	Satin Nickel	146.80
	582W7MB15	Matte Black	158.05
	582W7BBZ15	Brushed Bronze	158.05



 <ul style="list-style-type: none"> • Multifunction Hand Shower System • Coordinates with Allura and Braston collections • 4" HydroMersion hand shower wand with 7 modes • EverFlow rubber spray nozzles • Integrated wall cradle and elbow • 60" flexible metal hose • Traditional style • 2.0 gpm (7.6 L/min) flow rate 	HR707	Chrome	440.10
	HR707STN	Satin Nickel	572.15
	HR707MB	Matte Black	616.15
	HR707BBZ	Brushed Bronze	616.15



Braston™ Shower and Tub/Shower Accessories



DESCRIPTION	MODEL	FINISH	PRICE
• Multifunction Hand Shower Slide Bar System	HR727 HR727STN	Chrome Satin Nickel	530.10 689.10
• Coordinates with Allura and Braston collections	HR727MB HR727BBZ	Matte Black Brushed Bronze	742.05 742.05
• 4" HydroMersion hand shower wand with 7 modes			
• EverFlow rubber spray nozzles			
• 30" hand shower slide bar			
• 60" flexible metal hose			
• Traditional style			
• 2.0 gpm (7.6 L/min) flow rate			



• 24" or 36" Slide/Grab Bar	<i>24" Length</i>		
• Contemporary/Modern style	H35924	Chrome	586.05
• 4" HydroMersion hand shower wand with 7 modes	H35924STN H35924MB	Satin Nickel Matte Black	770.25 820.45
• EverFlow rubber spray nozzles	<i>36" Length</i>		
• 60" flexible metal hose	H35936	Chrome	598.05
• 1-1/2" diameter slide bar	H35936STN	Satin Nickel	787.05
• Pause mode for non-positive shutoff	H35936MB	Matte Black	834.55
• ADA slide mechanism			
• Wall elbow included			
• 2.0 gpm (7.6 L/min) flow rate			





• Shower Arm and Flange	582SA	Chrome	101.55
• Standard on the Braston collection	582SASTN	Satin Nickel	132.05
• 8-1/4" length	582SAMB	Matte Black	142.25
• Matte Black finish is Special Order	582SABBZ	Brushed Bronze	142.25





• Braston Tub Spout	582TS	Chrome	73.95
• 7-1/16" length	582TSSTN	Satin Nickel	96.00
• Metal construction	582TSMB	Matte Black	103.40
• Slip-on installation	582TSBBZ	Brushed Bronze	103.40
• Matte Black finish is Special Order			



Braston™ Shower and Tub/Shower Accessories





	DESCRIPTION	MODEL	FINISH	PRICE
	• Braston Diverter Tub Spout	582DTS	Chrome	73.95
	• 7-1/16" length	582DTSSSTN	Satin Nickel	96.00
	• Pull-up diverter	582DTSMB	Matte Black	103.40
	• Metal construction	582DTSBBZ	Brushed Bronze	103.40
	• Slip-on installation			
	• Matte Black finish is Special Order			
				

	• Braston Diverter Valve Trim	<i>Trim Only: 2DIV-BODY or 3DIV-BODY required (see page 158)</i>		
	• 5" diameter	58DIVTRM	Chrome	349.25
	• Metal handle	58DIVSTNTRM	Satin Nickel	454.05
	• Screwless escutcheon	58DIVMBTRM	Matte Black	489.00
	• Dual or triple outlet	58DIVBBZTRM	Brushed Bronze	489.00
	• Matte Black finish is Special Order			
				



Modifications for Braston Shower and Tub/Shower Accessories

SUFFIX	DESCRIPTION	CHROME	STN	BBZ	MB
15	1.5 gpm (5.7 L/min) flow restrictor	N/A	N/A	N/A	N/A

Braston™ Bath Accessories

	DESCRIPTION	MODEL	FINISH	PRICE	
	<ul style="list-style-type: none"> • 18" or 24" Towel Bar • Coordinates with Allura and Braston collections • Durable mounting system • Metal construction 	<i>18" Length</i>			
		583TB18	Chrome	100.45	
		583TB18STN	Satin Nickel	130.55	
		583TB18MB	Matte Black	140.60	
		583TB18BBZ	Brushed Bronze	140.60	
		<i>24" Length</i>			
		583TB24	Chrome	110.20	
		583TB24STN	Satin Nickel	143.15	
		583TB24MB	Matte Black	154.15	
		583TB24BBZ	Brushed Bronze	154.15	
	<ul style="list-style-type: none"> • Robe Hook • Coordinates with Allura and Braston collections • Durable mounting system • Metal construction 	583RH	Chrome	32.50	
		583RHSTN	Satin Nickel	42.25	
		583RHMB	Matte Black	45.50	
		583RHBBZ	Brushed Bronze	45.50	
	<ul style="list-style-type: none"> • Towel Ring • Coordinates with Allura and Braston collections • Durable mounting system • Metal construction 	583TR	Chrome	63.95	
		583TRSTN	Satin Nickel	83.25	
		583TRMB	Matte Black	89.55	
		583TRBBZ	Brushed Bronze	89.55	
	<ul style="list-style-type: none"> • Toilet Paper Holder • Coordinates with Allura and Braston collections • Durable mounting system • Metal construction 	583TP	Chrome	61.65	
		583TPSTN	Satin Nickel	80.20	
		583TPMB	Matte Black	86.35	
		583TPBBZ	Brushed Bronze	86.35	
	<ul style="list-style-type: none"> • Double Toilet Paper Holder • Coordinates with Allura and Braston collections • Durable mounting system • Metal construction • Matte Black finish is Special Order 	583DTP	Chrome	137.90	
		583DTPSTN	Satin Nickel	179.25	
		583DTPMB	Matte Black	193.00	
		583DTPBBZ	Brushed Bronze	193.00	

Braston™ Bath Accessories

	DESCRIPTION	MODEL	FINISH	PRICE
	• Double Robe Hook	583DRH	Chrome	84.25
	• Coordinates with Allura and Braston collections	583DRHSTN	Satin Nickel	109.60
		583DRHMB	Matte Black	118.00
	• Durable mounting system	583DRHBBZ	Brushed Bronze	118.00
	• Metal construction • Matte Black finish is Special Order			
	P			
	• 24" or 36" Grab Bar	<i>24" Length</i>		
	• Coordinates with Allura and Braston collections	583GB24	Chrome	249.15
		583GB24STN	Satin Nickel	323.90
	• Metal construction	583GB24MB	Matte Black	348.80
	• ADA compliant	583GB24BBZ	Brushed Bronze	348.80
	• Matte Black finish is Special Order	<i>36" Length</i>		
		583GB36	Chrome	261.55
		583GB36STN	Satin Nickel	340.00
		583GB36MB	Matte Black	366.15
		583GB36BBZ	Brushed Bronze	366.15
	P 			

Dia® Collection



The Dia Collection from Symmons expresses Modern Industrial concepts in functional forms, with a cylindrical motif that brings Minimalism to any bath space.

Available in these finishes:

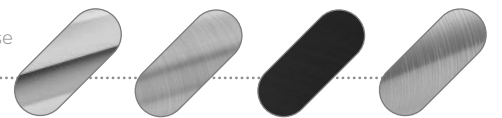

Polished
Chrome

Satin Nickel
Radiance® PVD
(STN)

Matte
Black
(MB)

Brushed Bronze
Radiance® PVD
(BBZ)

Faucets • Tub/Showers • Accessories

Dia® Lavatory Faucets

	DESCRIPTION	MODEL	FINISH	PRICE
	• Dia Single Handle Lavatory Faucet	SLS3512PP	Chrome	380.20
	• Single-hole installation	SLS3512STNPP	Satin Nickel	489.70
	• 7-1/8" height	SLS3512MBPP	Matte Black	551.40
	• 3/8" braided hose connections	SLS3512BBZPP	Brushed Bronze	551.40
	• Ceramic cartridges			
	• Metal construction			
	• Metal push-pop drain assembly included			
	• 1.0 gpm (3.8 L/min) flow rate			
	WS P  LF			
	• Dia Single Handle Lavatory Faucet	SLS3522PP	Chrome	380.20
	• Single-hole installation	SLS3522STNPP	Satin Nickel	489.70
	• 5" height	SLS3522MBPP	Matte Black	551.40
	• 3/8" braided hose connections	SLS3522BBZPP	Brushed Bronze	551.40
	• Ceramic cartridges			
	• Metal construction			
	• Metal push-pop drain assembly included			
	• 1.0 gpm (3.8 L/min) flow rate			
	WS P  LF			
	• Dia Centerset Lavatory Faucet	SLC3512PP	Chrome	353.30
	• 3-hole installation with 4" center	SLC3512STNPP	Satin Nickel	464.30
	• 1/2" IPS connections			
	• Ceramic cartridges			
	• Solid brass construction			
	• Metal push-pop drain assembly included			
	• 1.0 gpm (3.8 L/min) flow rate			
	WS P  LF			
	• Dia Widespread Lavatory Faucet	SLW3512PP	Chrome	561.85
	• 3-hole installation with 8-16" center	SLW3512STNPP	Satin Nickel	730.25
	• 7-1/4" spout height	SLW3512MBPP	Matte Black	790.85
	• Threadless valve-to-spout connections	SLW3512BBZPP	Brushed Bronze	790.85
	• 3/8" braided hose connections			
	• Ceramic cartridges			
	• Metal push-pop drain assembly included			
	• 1.0 gpm (3.8 L/min) flow rate			
	WS P  LF			

Dia® Lavatory Faucets



DESCRIPTION	MODEL	FINISH	PRICE
• Dia Widespread Lavatory Faucet	SLW3522PP	Chrome	561.85
• 3-hole installation with 8-16" center	SLW3522STNPP	Satin Nickel	730.25
• 5-3/4" spout height	SLW3522MBPP	Matte Black	786.60
• Threadless valve-to-spout connections	SLW3522BBZPP	Brushed Bronze	786.60
• 3/8" braided hose connections			
• Ceramic cartridges			
• Metal push-pop drain assembly included			
• 1.0 gpm (3.8 L/min) flow rate			



• Dia Widespread Lavatory Faucet	SLW3512H3PP	Chrome	579.60
• 3-hole installation with 8-16" center	SLW3512STNH3PP	Satin Nickel	753.50
• 7-1/4" spout height			
• Cross handles			
• Threadless valve-to-spout connections			
• 3/8" braided hose connections			
• Ceramic cartridges			
• Metal push-pop drain assembly included			
• 1.0 gpm (3.8 L/min) flow rate			

















DESCRIPTION	MODEL	FINISH	PRICE
• Dia Freestanding Tub Filler	<i>If tempering valve is required, use MaxLine® 7-230 Series (page 208)</i>		
• Floor-mounted tub filler with single-handle temperature control	FSTF357220	Chrome	1996.75
	FSTF357220STN	Satin Nickel	2595.85
• Single-function hand shower wand	FSTF357220MB	Matte Black	2795.50
• 60" flexible metal hose	FSTF357220BBZ	Brushed Bronze	2795.50
• Metal lever handle			
• 2.0 gpm (7.6 L/min) flow rate hand shower			
• 5.3 gpm (20.1 L/min) at 45 psi tub filler			



Modifications for Dia Lavatory Faucets and Tub Filler

SUFFIX	DESCRIPTION	CHROME	STN	BBZ	MB
05	0.5 gpm (1.9 L/min) flow restrictor	N/A	N/A	N/A	N/A
L2	Less hand shower wand	-45.20	-58.70	-63.25	-63.25

	DESCRIPTION	MODEL	FINISH	PRICE			
 	<ul style="list-style-type: none"> Dia Shower Trim with VersaFlex Integral Diverter/Volume Control 4" HydroMersion showerhead with 7 modes EverFlow rubber spray nozzles VersaFlex Integral Diverter/Volume Control lever Metal handle and escutcheon 2.0 gpm (7.6 L/min) flow rate 	<i>Trim Only: S26 Series Temptrol® valve required (see page 151)</i> S3591BTRM S3591BSTNTRM S3591BMBTRM S3591BBBZTRM <i>Trim Only with flow control spindle and cap nut: S16 Series Temptrol® valve required (see page 151)</i> S3591BTRMTC S3591BSTNTRMTC S3591BMBTRMTC S3591BBBZTRMTC	Chrome Satin Nickel Matte Black Brushed Bronze Chrome Satin Nickel Matte Black Brushed Bronze	376.20 484.05 529.60 529.60 453.70 561.55 607.10 607.10			
	WS P 						
	 	<ul style="list-style-type: none"> Dia Shower Trim 4" HydroMersion showerhead with 7 modes EverFlow rubber spray nozzles Metal handle and escutcheon 2.0 gpm (7.6 L/min) flow rate 	<i>Trim Only: 26 Series Temptrol® valve required (see page 139)</i> 3591BTRM 3591BSTNTRM 3591BMBTRM 3591BBBZTRM <i>Trim Only with flow control spindle and cap nut: 16 Series Temptrol® valve required (see page 139)</i> 3591BTRMTC 3591BSTNTRMTC 3591BMBTRMTC 3591BBBZTRMTC	Chrome Satin Nickel Matte Black Brushed Bronze Chrome Satin Nickel Matte Black Brushed Bronze	348.50 488.55 490.50 490.50 426.00 566.05 568.00 568.00		
		WS P 					
		  	<ul style="list-style-type: none"> Dia Tub and Shower Trim with VersaFlex Integral Diverter 4" HydroMersion showerhead with 7 modes EverFlow rubber spray nozzles VersaFlex Integral Diverter lever 7" slip-on non-diverter tub spout Metal handle and escutcheon 2.0 gpm (7.6 L/min) flow rate 	<i>Trim Only: S26 Series Temptrol® valve required (see page 147)</i> S3592BTRM S3592BSTNTRM S3592BMBTRM S3592BBBZTRM <i>Trim Only with flow control spindle and cap nut: S16 Series Temptrol® valve required (see page 147)</i> S3592BTRMTC S3592BSTNTRMTC S3592BMBTRMTC S3592BBBZTRMTC	Chrome Satin Nickel Matte Black Brushed Bronze Chrome Satin Nickel Matte Black Brushed Bronze	410.00 511.95 577.20 577.20 487.50 589.45 654.70 654.70	
			WS P 				
			  	<ul style="list-style-type: none"> Dia Tub and Shower Trim 4" HydroMersion showerhead with 7 modes EverFlow rubber spray nozzles 7" slip-on diverter tub spout Metal handle and escutcheon 2.0 gpm (7.6 L/min) flow rate 	<i>Trim Only: 26 Series Temptrol® valve required (see page 139)</i> 3592BTRM 3592BSTNTRM 3592BMBTRM 3592BBBZTRM <i>Trim Only with flow control spindle and cap nut: 16 Series Temptrol® valve required (see page 139)</i> 3592BTRMTC 3592BSTNTRMTC 3592BMBTRMTC 3592BBBZTRMTC	Chrome Satin Nickel Matte Black Brushed Bronze Chrome Satin Nickel Matte Black Brushed Bronze	370.95 543.70 556.35 556.35 448.45 621.20 633.85 633.85
				WS P 			



DESCRIPTION	MODEL	FINISH	PRICE
• Dia Hand Shower Trim	<i>Trim Only: 26 Series Temptrol® valve required (see page 139)</i>		
• 4" HydroMersion hand shower wand with 7 modes	3593BTRM	Chrome	723.55
	3593BSTNTRM	Satin Nickel	955.40
• EverFlow rubber spray nozzles	3593BMBTRM	Matte Black	1032.75
• 30" hand shower slide bar	3593BBBZTRM	Brushed Bronze	1032.75
• 60" flexible metal hose	<i>Trim Only with flow control spindle and cap nut: 16 Series Temptrol® valve required (see page 139)</i>		
• Metal handle and escutcheon	3593BTRMTC	Chrome	801.05
• 2.0 gpm (7.6 L/min) flow rate	3593BSTNTRMTC	Satin Nickel	1032.90
	3593BMBTRMTC	Matte Black	1110.25
	3593BBBZTRMTC	Brushed Bronze	1110.25



• Dia Tub and Hand Shower Trim with VersaFlex Integral Diverter	<i>Trim Only: S26 Series Temptrol® valve required (see page 147)</i>		
	S3594BTRM	Chrome	789.05
• 4" HydroMersion hand shower wand with 7 modes	S3594BSTNTRM	Satin Nickel	1025.75
	S3594BMBTRM	Matte Black	1201.85
• EverFlow rubber spray nozzles	S3594BBBZTRM	Brushed Bronze	1201.85
• VersaFlex Integral Diverter lever	<i>Trim Only with flow control spindle and cap nut: S16 Series Temptrol® valve required (see page 147)</i>		
• 7" slip-on non-diverter tub spout	S3594BTRMTC	Chrome	866.55
• 30" hand shower slide bar	S3594BSTNTRMTC	Satin Nickel	1103.25
• 60" flexible metal hose	S3594BMBTRMTC	Matte Black	1279.35
• Metal handle and escutcheon	S3594BBBZTRMTC	Brushed Bronze	1279.35
• 2.0 gpm (7.6 L/min) flow rate			





• Dia Shower and Hand Shower Trim with VersaFlex Integral Diverter	<i>Trim Only: S26 Series Temptrol® valve required (see page 147)</i>		
	S3598BTRM	Chrome	810.25
• 4" HydroMersion showerhead and hand shower wand with 7 modes	S3598BSTNTRM	Satin Nickel	1053.40
	S3598BMBTRM	Matte Black	1220.60
• EverFlow rubber spray nozzles	S3598BBBZTRM	Brushed Bronze	1220.60
• VersaFlex Integral Diverter lever	<i>Trim Only with flow control spindle and cap nut: S16 Series Temptrol® valve required (see page 147)</i>		
• 30" hand shower slide bar	S3598BTRMTC	Chrome	887.75
• 60" flexible metal hose	S3598BSTNTRMTC	Satin Nickel	1130.90
• Metal handle and escutcheon	S3598BMBTRMTC	Matte Black	1298.10
• 2.0 gpm (7.6 L/min) flow rate	S3598BBBZTRMTC	Brushed Bronze	1298.10



• Dia Shower and Hand Shower Trim	<i>Trim Only: 26 Series Temptrol® and 2DIV Series valves required (see pages 139 and 158)</i>		
• 4" HydroMersion showerhead and hand shower wand with 7 modes	3595BTRM	Chrome	1081.20
	3595BSTNTRM	Satin Nickel	1483.20
• EverFlow rubber spray nozzles	3595BMBTRM	Matte Black	1522.25
• Separate dual outlet diverter trim	3595BBBZTRM	Brushed Bronze	1522.25
• 30" hand shower slide bar	<i>Trim Only with flow control spindle and cap nut: 16 Series Temptrol® and 2DIV Series valves required (see pages 139 and 158)</i>		
• 60" flexible metal hose	3595BTRMTC	Chrome	1158.70
• Metal handle and escutcheon	3595BSTNTRMTC	Satin Nickel	1560.70
• 2.0 gpm (7.6 L/min) flow rate	3595BMBTRMTC	Matte Black	1599.75
	3595BBBZTRMTC	Brushed Bronze	1599.75



Dia® Shower and Tub/Shower

	DESCRIPTION	MODEL	FINISH	PRICE
	• Dia Shower System Trim	<i>Trim Only: 26 Series Temptrol® and 3DIV Series valves required (see pages 139 and 158)</i>		
	• 4" HydroMersion showerhead and hand shower wand with 7 modes	3596BTRM	Chrome	1143.65
	• EverFlow rubber spray nozzles	3596BSTNTRM	Satin Nickel	1524.85
	• Separate triple outlet diverter trim	3596BMBTRM	Matte Black	1610.05
	• 30" hand shower slide bar	3596BBBZTRM	Brushed Bronze	1610.05
	• 60" flexible metal hose	<i>Trim Only with flow control spindle and cap nut: 16 Series Temptrol® and 3DIV Series valves required (see pages 139 and 158)</i>		
	• 7" slip-on non-diverter tub spout	3596BTRMTC	Chrome	1221.15
	• Metal handle and escutcheon	3596BSTNTRMTC	Satin Nickel	1602.35
	• 2.0 gpm (7.6 L/min) flow rate	3596BMBTRMTC	Matte Black	1687.55
			3596BBBZTRMTC	Brushed Bronze
	• Dia Shower Valve Trim with VersaFlex Integral Diverter/Volume Control	<i>Trim Only: S26 Series Temptrol® valve required (see pages 147 and 151)</i>		
	• VersaFlex Integral Diverter/Volume Control lever	S3590BTRM	Chrome	274.55
	• Metal handle and escutcheon	S3590BSTNTRM	Satin Nickel	389.15
		S3590BMBTRM	Matte Black	423.60
		S3590BBBZTRM	Brushed Bronze	423.60
		<i>Trim Only with flow control spindle and cap nut: S16 Series Temptrol® valve required (see pages 147 and 151)</i>		
		S3590BTRMTC	Chrome	352.05
		S3590BSTNTRMTC	Satin Nickel	466.65
		S3590BMBTRMTC	Matte Black	501.10
		S3590BBBZTRMTC	Brushed Bronze	501.10
	• Dia Shower Valve Trim	<i>Trim Only: 26 Series Temptrol® valve required (see page 139)</i>		
	• Metal handle and escutcheon	3590BTRM	Chrome	261.65
		3590BSTNTRM	Satin Nickel	347.60
		3590BMBTRM	Matte Black	368.35
		3590BBBZTRM	Brushed Bronze	368.35
		<i>Trim Only with flow control spindle and cap nut: 16 Series Temptrol® valve required (see page 139)</i>		
		3590BTRMTC	Chrome	339.15
		3590BSTNTRMTC	Satin Nickel	425.10
		3590BMBTRMTC	Matte Black	445.85
		3590BBBZTRMTC	Brushed Bronze	445.85



Modifications for Dia Shower and Tub/Shower Systems

SUFFIX	DESCRIPTION	CHROME	STN	BBZ	MB
15	 1.5 gpm (5.7 L/min) flow restrictor	N/A	N/A	N/A	N/A
L1	Less showerhead	43.60	-56.80	-61.50	-61.50
L2	Less hand shower	-45.20	-58.70	-63.25	-63.25
L3	Less showerhead and hand shower	-88.80	-115.45	-124.30	-124.30
L4	Less showerhead, arm and flange	-57.80	-75.15	-81.90	-81.90
L5	Less hand shower system	-222.90	-289.70	-312.10	-312.10
L6	Less tub spout	-29.40	-41.30	-42.80	-42.80
L7	Less handle	-57.90	-73.25	-80.95	-80.95
Delete Suffix B	Chrome plastic escutcheon on valve with color graphics/indicators in place of standard brass escutcheon	-72.25	-97.30	N/A	N/A

Dia® Shower and Tub/Shower Accessories

	DESCRIPTION	MODEL	FINISH	PRICE
	<ul style="list-style-type: none"> • Multifunction Showerhead • Standard on the Dia collection • 4" diameter • 7 modes • HydroMersion technology for increased force • EverFlow rubber spray nozzles • Easy-shift thumb lever • Solid brass ball joint • Contemporary/Modern style 	<i>2.0 gpm (7.6 L/min) standard</i>		
		482SH7	Chrome	109.05
		482SH7STN	Satin Nickel	141.80
		482SH7MB	Matte Black	153.70
		482SH7BBZ	Brushed Bronze	153.70
		<i>1.5 gpm (5.7 L/min) WaterSense®, CALGreen</i>		
		482SH715	Chrome	109.05
		482SH7STN15	Satin Nickel	141.80
		482SH7MB15	Matte Black	153.70
		482SH7BBZ15	Brushed Bronze	153.70



	<ul style="list-style-type: none"> • Multifunction Showerhead • 6" diameter • 7 modes • HydroMersion technology for increased force • EverFlow rubber spray nozzles • Solid brass ball joint • Contemporary/Modern style 	<i>2.0 gpm (7.6 L/min) standard</i>		
		682SH7	Chrome	234.65
		682SH7STN	Satin Nickel	305.10
		682SH7MB	Matte Black	328.50
		682SH7BBZ	Brushed Bronze	328.50
		<i>1.5 gpm (5.7 L/min) WaterSense®, CALGreen</i>		
		682SH715	Chrome	234.65
		682SH7STN15	Satin Nickel	305.10
		682SH7MB15	Matte Black	328.50
		682SH7BBZ15	Brushed Bronze	328.50



	<ul style="list-style-type: none"> • Single-Function Showerhead • 6" diameter • HydroMersion technology for increased force • Total spray for complete coverage • EverFlow rubber spray nozzles • Solid brass ball joint • Contemporary/Modern style 	<i>2.0 gpm (7.6 L/min) standard</i>		
		682SH	Chrome	157.25
		682SHSTN	Satin Nickel	204.35
		682SHMB	Matte Black	220.10
		682SHBBZ	Brushed Bronze	220.10
		<i>1.5 gpm (5.7 L/min) WaterSense®, CALGreen</i>		
		682SH15	Chrome	157.25
		682SHSTN15	Satin Nickel	204.35
		682SHMB15	Matte Black	220.10
		682SHBBZ15	Brushed Bronze	220.10



	<ul style="list-style-type: none"> • Multifunction Hand Shower Wand • Standard on the Dia collection • 4" diameter • 7 modes • HydroMersion technology for increased force • EverFlow rubber spray nozzles • Easy-shift thumb lever • Pause mode for non-positive shutoff • Contemporary/Modern style 	<i>2.0 gpm (7.6 L/min) standard</i>		
		482W7	Chrome	112.90
		482W7STN	Satin Nickel	146.80
		482W7MB	Matte Black	158.05
		482W7BBZ	Brushed Bronze	158.05
		<i>1.5 gpm (5.7 L/min) WaterSense®, CALGreen</i>		
		482W715	Chrome	112.90
		482W7STN15	Satin Nickel	146.80
		482W7MB15	Matte Black	158.05
		482W7BBZ15	Brushed Bronze	158.05



Dia® Shower and Tub/Shower Accessories



DESCRIPTION	MODEL	FINISH	PRICE
<ul style="list-style-type: none"> • Single-Function Hand Shower Wand • Standard on the Identity collection • 4" diameter • HydroMersion technology for increased force • Total spray for complete coverage 	<i>2.0 gpm (7.6 L/min) standard</i> 482W 482WSTN 482WMB 482WBBZ	Chrome Satin Nickel Matte Black Brushed Bronze	85.75 111.45 120.05 120.05
<ul style="list-style-type: none"> • Pause mode for non-positive shutoff • EverFlow rubber spray nozzles • Easy-shift thumb lever • Contemporary/Modern style 	482W 482WSTN15 482WMB15 482WBBZ15	Chrome Satin Nickel Matte Black Brushed Bronze	85.75 111.45 120.05 120.05



<ul style="list-style-type: none"> • Multifunction Hand Shower System • Coordinates with the Dia collection • 4" HydroMersion hand shower wand with 7 modes • EverFlow rubber spray nozzles • Wall cradle and elbow • 60" flexible metal hose • Contemporary/Modern style • 2.0 gpm (7.6 L/min) flow rate 	HR507 HR507STN HR507MB HR507BBZ	Chrome Satin Nickel Matte Black Brushed Bronze	467.25 607.45 654.20 654.20
---	--	---	--------------------------------------



<ul style="list-style-type: none"> • Multifunction Hand Shower Slide Bar System • Coordinates with the Dia collection • 4" HydroMersion hand shower wand with 7 modes • EverFlow rubber spray nozzles • 30" hand shower slide bar • 60" flexible metal hose • Contemporary/Modern style • 2.0 gpm (7.6 L/min) flow rate 	HR527 HR527STN HR527MB HR527BBZ	Chrome Satin Nickel Matte Black Brushed Bronze	557.20 724.35 780.05 780.05
---	--	---	--------------------------------------

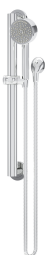

Dia® Shower and Tub/Shower Accessories

	DESCRIPTION	MODEL	FINISH	PRICE
	• 24" or 36" Slide/Grab Bar	<i>24" Length</i>		
	• Contemporary/Modern style	H35924	Chrome	586.05
	• 4" HydroMersion hand shower wand with 7 modes	H35924STN	Satin Nickel	770.25
	• EverFlow rubber spray nozzles	H35924MB	Matte Black	820.45
	• 60" flexible metal hose	<i>36" Length</i>		
	• 60" flexible metal hose	H35936	Chrome	598.05
	• 1-1/2" diameter slide bar	H35936STN	Satin Nickel	787.05
	• Pause mode for non-positive shutoff	H35936MB	Matte Black	834.55
	• ADA slide mechanism			
	• Wall elbow included			
• 2.0 gpm (7.6 L/min) flow rate				



	• Exposed Shower Riser	35EX	Chrome	718.55
	• Round flanges	35EX-STN	Satin Nickel	1006.05
	• Metal lever handle	35EX-MB	Matte Black	1006.05
	• Diverter included for toggling between distinct showerhead and hand shower positions			
	• Includes column/slide bar and hand shower bracket			
	• 60" flexible metal hose			
• Hand shower and showerhead not included				



	• Short shower arm and flange	300S	Chrome	26.85
	• Stamped flange	300S-STN	Satin Nickel	40.30
	• 6" length	300S-MB	Matte Black	41.25
		300S-BBZ	Brushed Bronze	41.25



	• Non-diverter tub spout	067	Chrome	66.40
	• 7" length	067-STN	Satin Nickel	92.70
	• Metal construction	067-MB	Matte Black	96.20
	• Thread-on installation	067-BBZ	Brushed Bronze	96.20



	• Diverter tub spout	352TS	Chrome	59.25
	• 7" length	352TS-STN	Satin Nickel	79.00
	• Pull-up diverter	352TS-MB	Matte Black	83.60
	• Metal construction	352TS-BBZ	Brushed Bronze	83.60
	• Thread-on installation			



Dia® Shower and Tub/Shower Accessories



DESCRIPTION

- Dia Diverter Valve Trim
- 5" diameter
- Metal lever handle
- Screwless escutcheon
- Dual or triple outlet



MODEL

Trim Only: 2DIV-BODY or 3DIV-BODY required (see page 158)

- 35-2DIV-CYL-TRM
- 35-2DIV-CYL-STN-TRM
- 35-2DIV-CYL-MB-TRM
- 35-2DIV-CYL-BBZ-TRM

FINISH







- Chrome
- Satin Nickel
- Matte Black
- Brushed Bronze

PRICE







- 283.90
- 415.15
- 497.35
- 497.35









Modifications for Dia Shower and Tub/Shower Accessories

SUFFIX	DESCRIPTION	CHROME	STN	BBZ	MB
15	 1.5 gpm (5.7 L/min) flow restrictor	N/A	N/A	N/A	N/A





	DESCRIPTION	MODEL	FINISH	PRICE
	<ul style="list-style-type: none"> • 18" or 24" Towel Bar • Coordinates with Dia and Identity collections • Metal construction • Durable mounting system 	<i>18" Length</i>		
		353TB-18	Chrome	87.65
		353TB-18-STN	Satin Nickel	113.70
		353TB-18-MB	Matte Black	123.30
		353TB-18-BBZ	Brushed Bronze	123.30
		<i>24" Length</i>		
		353TB-24	Chrome	96.10
		353TB-24-STN	Satin Nickel	125.00
		353TB-24-MB	Matte Black	135.25
		353TB-24-BBZ	Brushed Bronze	135.25
	<ul style="list-style-type: none"> • 18" or 24" Double Towel Bar • Coordinates with Dia and Identity collections • Metal construction • Durable mounting system 	<i>18" Length</i>		
		353DTB-18	Chrome	154.80
		353DTB-18-STN	Satin Nickel	201.15
		<i>24" Length</i>		
		353DTB-24	Chrome	164.30
		353DTB-24-STN	Satin Nickel	213.45
	<ul style="list-style-type: none"> • 18" or 24" Towel Bar with Assist Bar • Coordinates with Dia and Identity collections • Stainless-steel construction • Durable mounting system • ADA compliant 	<i>18" Length</i>		
		353GBTB-18	Chrome	181.00
		353GBTB-18-STN	Satin Nickel	253.60
		<i>24" Length</i>		
		353GBTB-24	Chrome	201.15
		353GBTB-24-STN	Satin Nickel	281.60
	<ul style="list-style-type: none"> • 22" Towel Shelf with Bar • Coordinates with Dia and Identity collections • Metal construction • Durable mounting system 	353TS-22	Chrome	315.70
		353TS-22-STN	Satin Nickel	410.45
		<i>24" Length</i>		
		353TS-24	Chrome	315.70
	<ul style="list-style-type: none"> • Robe Hook • Coordinates with Dia and Identity collections • Durable mounting system • Metal construction 	353RH	Chrome	28.20
		353RH-STN	Satin Nickel	36.65
		353RH-MB	Matte Black	40.80
		353RH-BBZ	Brushed Bronze	40.80
		<i>24" Length</i>		
	<ul style="list-style-type: none"> • Robe Hook • Coordinates with Dia and Identity collections • Metal construction • Glass mount installation only 	0142-353GMRH	Chrome	128.05
		<i>24" Length</i>		

Dia® Bath Accessories

	DESCRIPTION	MODEL	FINISH	PRICE
	• Double Robe Hook	353DRH	Chrome	30.95
	• Coordinates with Dia and Identity collections	353DRH-STN	Satin Nickel	40.20
		353DRH-MB	Matte Black	43.60
	• Durable mounting system	353DRH-BBZ	Brushed Bronze	43.60
	• Metal construction			
	P			
	• Towel Ring	353TR	Chrome	55.75
	• Coordinates with Dia and Identity collections	353TR-STN	Satin Nickel	72.40
		353TR-MB	Matte Black	83.80
	• Durable mounting system	353TR-BBZ	Brushed Bronze	83.80
	• Metal construction			
	P			
	• Toilet Paper Holder	353TP	Chrome	53.65
	• Coordinates with Dia and Identity collections	353TP-STN	Satin Nickel	69.80
		353TP-MB	Matte Black	79.95
	• Durable mounting system	353TP-BBZ	Brushed Bronze	79.95
	• Metal construction			
	P			
	• Toilet Paper Holder with Cover	353TPC	Chrome	84.55
	• Coordinates with Dia and Identity collections	353TPC-STN	Satin Nickel	109.80
	• Durable mounting system			
	• Metal construction			
	P			
	• Toilet Paper Holder	0323-3TP	Chrome	199.25
	• Coordinates with Dia and Identity collections			
	• Durable mounting system			
	• Metal construction			
	• Mounts vertical or horizontal			
	P			
	• Toilet Paper Holder with Assist Bar	353GBTP	Chrome	182.90
	• Coordinates with Dia and Identity collections	353GBTP-STN	Satin Nickel	255.95
	• Durable mounting system			
	• Stainless-steel construction			
	• ADA compliant			
	P 			

DESCRIPTION	MODEL	FINISH	PRICE
<ul style="list-style-type: none"> • Soap Dish • Metal construction 	353SD	Chrome	90.60
	353SD-STN	Satin Nickel	117.80
			
<p>P</p> <ul style="list-style-type: none"> • Curved Shower Rod • Contemporary/Modern style • Metal construction 	<i>5' Length</i>		
	353SR-5	Chrome	121.00
	353SR-5-STN	Satin Nickel	178.10
<p>P</p>	<i>6' Length</i>		
	353SR-6	Chrome	139.30
	353SR-6-STN	Satin Nickel	207.75
<ul style="list-style-type: none"> • Grab Bar • Coordinates with Dia and Identity collections • Durable mounting system • Stainless-steel construction • Screwless flanges • ADA compliant 	<i>12" Length</i>		
	353GB-12	Chrome	185.50
	353GB-12-STN	Satin Nickel	259.60
	<i>18" Length</i>		
	353GB-18	Chrome	199.45
	353GB-18-STN	Satin Nickel	279.25
	353GB18MB	Matte Black	279.25
	353GB18BBZ	Brushed Bronze	265.95
	<i>24" Length</i>		
	353GB-24	Chrome	249.15
	353GB-24-STN	Satin Nickel	335.00
	353GB24MB	Matte Black	335.00
	353GB24BBZ	Brushed Bronze	335.00
	<i>36" Length</i>		
	353GB-36	Chrome	261.55
	353GB-36-STN	Satin Nickel	351.70
	353GB36MB	Matte Black	351.70
	353GB36BBZ	Brushed Bronze	351.70
<p>P </p>	<i>42" Length</i>		
	353GB-42	Chrome	263.65
	353GB-42-STN	Satin Nickel	369.20

Dia® Kitchen and Bar Sink Faucets

	DESCRIPTION	MODEL	FINISH	PRICE
	• Single Handle Pull-Down Kitchen Faucet	SK2302PD	Chrome	532.90
	• Single-hole mount	SK2302STSPD	Stainless Steel	666.20
	• Ceramic cartridge	SK2302MBPD	Matte Black	772.75
	• Braided hose connections	SK2302BBZPD	Brushed Bronze	772.75
	• 2-function pull-down spout • Rotating spray selection • 360° swivel spout • 1.5 gpm (5.7 L/min) standard			
P & LF				
	• Dia Pull-Down Kitchen Faucet	SK3510PD	Chrome	532.90
	• Single-hole mount	SK3510STSPD	Stainless Steel	666.20
	• Pull-down wand with two-mode spray-to-stream control	SK3510MBPD	Matte Black	772.75
	• Braided hose connections	SK3510BBZPD	Brushed Bronze	772.75
	• 1.5 gpm (5.7 L/min) flow rate			
P & LF				
	• Dia Pull-Down Spring Kitchen Faucet	SPR3510PD	Chrome	826.70
	• Pull-down spray wand	SPR3510PDSTS	Stainless Steel	1128.05
	• Single-hole mount	SPR3510PDMB	Matte Black	1157.40
	• Ceramic cartridge • Braided hose connections • 1.5 gpm (5.7 L/min) standard			
P & LF				
	• Dia Pull Out Kitchen Faucet	SK7200PO	Chrome	832.35
	• Single-hole mount configuration			
	• Pull-out wand • Braided hose connections • 1.5 gpm (5.7 L/min) flow rate			
P & LF				
	• Dia Single Handle Kitchen Faucet	SK2660	Chrome	543.35
	• Single-hole mount configuration			
	• 8-3/8" swivel spout • Braided hose connections • 1.5 gpm (5.7 L/min) flow rate			
P & LF				

Dia® Kitchen and Bar Sink Faucets



DESCRIPTION	MODEL	FINISH	PRICE
• Dia Single Handle Bar Faucet	SPB3510	Chrome	429.70
• Single-hole mount	SPB3510STN	Satin Nickel	558.55
• Ceramic cartridge	SPB3510MB	Matte Black	601.55
• Braided hose connections	SPB3510BBZ	Brushed Bronze	601.55
• Standard swivel spout with option of rigid			
• 1.5 gpm (5.7 L/min) standard			



Modifications for Dia Kitchen and Bar Sink Faucets

SUFFIX	DESCRIPTION	CHROME	STN	BBZ	MB
10	1.0 gpm (3.8 L/min) flow restrictor (available on SK2302, SK3510 & SK2660)	N/A	N/A	N/A	N/A
DP	8" deck plate (SK3510 & SK2302)	104.65	146.40	151.70	151.70

Duro® Collection



The bold angular design of the Duro Collection reflects the concept of form and function as one ideal. The precise rectangular shapes present a clean, minimalist feel for any modern or contemporary bathroom.

Available in these finishes:

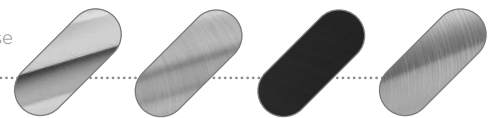

Polished
Chrome

Satin Nickel
Radiance® PVD
(STN)

Matte
Black
(MB)



Brushed Bronze
Radiance® PVD
(BBZ)



Faucets • Tub/Showers • Accessories



Duro® Lavatory and Roman Tub Faucets

	DESCRIPTION	MODEL	FINISH	PRICE
	• Duro Single Handle Lavatory Faucet	SLS3612PP	Chrome	438.35
	• Single-hole installation	SLS3612STNPP	Satin Nickel	569.75
	• 6-7/8" height	SLS3612MBPP	Matte Black	635.60
	• 3/8" braided hose connections	SLS3612BBZPP	Brushed Bronze	635.60
	• Ceramic cartridges • Metal construction • Metal push-pop drain assembly included • 1.0 gpm (3.8 L/min) flow rate			
				
	• Duro Single Handle Lavatory Faucet	SLS3622PP	Chrome	438.35
	• Single-hole installation	SLS3622STNPP	Satin Nickel	569.75
	• 4-1/2" height	SLS3622MBPP	Matte Black	635.60
	• 3/8" braided hose connections	SLS3622BBZPP	Brushed Bronze	635.60
	• Ceramic cartridges • Metal construction • Metal push-pop drain assembly included • 1.0 gpm (3.8 L/min) flow rate			
				
	• Duro Centerset Lavatory Faucet	SLC3612PP	Chrome	433.80
	• 3-hole installation with 4" center	SLC3612STNPP	Satin Nickel	565.20
	• 1/2" IPS connections			
	• Ceramic cartridges • Solid brass construction • Metal push-pop drain assembly included • 1.0 gpm (3.8 L/min) flow rate			
				
	• Duro Widespread Lavatory Faucet	SLW3612PP	Chrome	702.75
	• 3-hole installation with 8-16" center	SLW3612STNPP	Satin Nickel	913.50
	• 6-11/16" spout height	SLW3612MBPP	Matte Black	989.30
	• Threadless valve-to-spout connections	SLW3612BBZPP	Brushed Bronze	989.30
	• 3/8" braided hose connections • Ceramic cartridges • Metal push-pop drain assembly included • 1.0 gpm (3.8 L/min) flow rate			
				

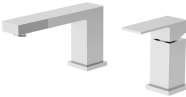
Duro® Lavatory and Roman Tub Faucets

	DESCRIPTION	MODEL	FINISH	PRICE
	• Duro Widespread Lavatory Faucet	SLW3622PP	Chrome	702.75
	• 3-hole installation with 8-16" center	SLW3622STNPP	Satin Nickel	913.50
	<ul style="list-style-type: none"> • 4-1/16" spout height • Threadless valve-to-spout connections • 3/8" braided hose connections • Ceramic cartridges • Metal push-pop drain assembly included • 1.0 gpm (3.8 L/min) flow rate 			
				

	• Duro Single Handle Roman Tub Faucet	SRT-0231	Chrome	2227.40
	• Ceramic cartridge	SRT-0231-STN	Satin Nickel	3006.95
	<ul style="list-style-type: none"> • 1/2" IPS inlet connections • Cast brass spout 			
				

	DESCRIPTION	MODEL	FINISH	PRICE
	• Duro Freestanding Tub Filler	<i>If tempering valve is required, use MaxLine® 7-230 Series (page 208)</i>		
	• Floor-mounted tub filler with single-handle temperature control	FSTF367220	Chrome	2196.45
	• Single-function hand shower wand	FSTF367220STN	Satin Nickel	2854.70
	• 60" flexible metal hose	FSTF367220MB	Matte Black	3075.10
	• Metal lever handle	FSTF367220BBZ	Brushed Bronze	3075.10
	<ul style="list-style-type: none"> • 2.0 gpm (7.6 L/min) flow rate hand shower • 5.3 gpm (20.1 L/min) at 45 psi tub filler 			
				

Modifications for Duro Lavatory Faucets and Tub Filler

SUFFIX	DESCRIPTION	CHROME	STN	BBZ	MB
05	 0.5 gpm (1.9 L/min) flow restrictor	N/A	N/A	N/A	N/A
L2	Less hand shower wand	-58.20	-75.70	-80.95	-80.95
DP4	4" deck plate for single hole mount faucets	50.75	66.00	73.55	73.55

Duro® Shower and Tub/Shower

DESCRIPTION	MODEL	FINISH	PRICE
 <ul style="list-style-type: none"> • Duro Shower Trim with VersaFlex Integral Diverter/Volume Control • 5" HydroMersion showerhead with Total spray • EverFlow rubber spray nozzles • VersaFlex Integral Diverter/Volume Control lever • Metal handle • 2.0 gpm (7.6 L/min) flow rate 	<i>Trim Only: S26 Series Temptrol® valve required (see page 151)</i>		
	S3691TRM	Chrome	376.20
	S3691STNTRM	Satin Nickel	573.75
	S3691MBTRM	Matte Black	583.80
	S3691BBZTRM	Brushed Bronze	583.80
	<i>Trim Only with flow control spindle and cap nut: S16 Series Temptrol® valve required (see page 151)</i>		
	S3691TRMTC	Chrome	453.70
	S3691STNTRMTC	Satin Nickel	651.25
	S3691MBTRMTC	Matte Black	661.30
	S3691BBZTRMTC	Brushed Bronze	661.30
WS P 			
 <ul style="list-style-type: none"> • Duro Shower Trim • 5" HydroMersion showerhead with Total spray • EverFlow rubber spray nozzles • Metal handle • 2.0 gpm (7.6 L/min) flow rate 	<i>Trim Only: 26 Series Temptrol® valve required (see page 139)</i>		
	3691TRM	Chrome	348.50
	3691STNTRM	Satin Nickel	488.55
	3691MBTRM	Matte Black	490.50
	3691BBZTRM	Brushed Bronze	490.50
	<i>Trim Only with flow control spindle and cap nut: 16 Series Temptrol® valve required (see page 139)</i>		
	3691TRMTC	Chrome	426.00
	3691STNTRMTC	Satin Nickel	566.05
	3691MBTRMTC	Matte Black	568.00
	3691BBZTRMTC	Brushed Bronze	568.00
WS P 			
 <ul style="list-style-type: none"> • Duro Tub and Shower Trim with VersaFlex Integral Diverter • 5" HydroMersion showerhead with Total spray • EverFlow rubber spray nozzles • VersaFlex Integral Diverter lever • 6" non-diverter tub spout • Metal handle • 2.0 gpm (7.6 L/min) flow rate 	<i>Trim Only: S26 Series Temptrol® valve required (see page 147)</i>		
	S3692TRM	Chrome	410.00
	S3692STNTRM	Satin Nickel	511.95
	S3692MBTRM	Matte Black	577.20
	S3692BBZTRM	Brushed Bronze	577.20
	<i>Trim Only with flow control spindle and cap nut: S16 Series Temptrol® valve required (see page 147)</i>		
	S3692TRMTC	Chrome	487.50
	S3692STNTRMTC	Satin Nickel	589.45
	S3692MBTRMTC	Matte Black	654.70
	S3692BBZTRMTC	Brushed Bronze	654.70
WS P 			
 <ul style="list-style-type: none"> • Duro Tub and Shower Trim • 5" HydroMersion showerhead with Total spray • EverFlow rubber spray nozzles • 6" diverter tub spout • Metal handle • 2.0 gpm (7.6 L/min) flow rate 	<i>Trim Only: 26 Series Temptrol® valve required (see page 139)</i>		
	3692TRM	Chrome	368.50
	3692STNTRM	Satin Nickel	543.70
	3692MBTRM	Matte Black	557.65
	3692BBZTRM	Brushed Bronze	557.65
	<i>Trim Only with flow control spindle and cap nut: 16 Series Temptrol® valve required (see page 139)</i>		
	3692TRMTC	Chrome	446.00
	3692STNTRMTC	Satin Nickel	621.20
	3692MBTRMTC	Matte Black	635.15
	3692BBZTRMTC	Brushed Bronze	635.15
WS P 			

Duro® Shower and Tub/Shower



DESCRIPTION	MODEL	FINISH	PRICE
	<i>Trim Only: 26 Series Temptrol® valve required (see page 139)</i>		
• Duro Hand Shower Trim	3693TRM	Chrome	723.70
• 2-1/2" x 4-1/2" HydroMersion hand shower wand with Total spray and push-button Pause mode	3693STNTRM	Satin Nickel	955.40
	3693MBTRM	Matte Black	1032.75
• EverFlow rubber spray nozzles	3693BBZTRM	Brushed Bronze	1032.75
	<i>Trim Only with flow control spindle and cap nut: 16 Series Temptrol® valve required (see page 139)</i>		
• 30" hand shower slide bar	3693TRMTC	Chrome	801.20
• 60" flexible metal hose	3693STNTRMTC	Satin Nickel	1032.90
• Metal handle	3693MBTRMTC	Matte Black	1110.25
• 2.0 gpm (7.6 L/min) flow rate	3693BBZTRMTC	Brushed Bronze	1110.25









	<i>Trim Only: S26 Series Temptrol® valve required (see page 147)</i>		
• Duro Tub and Hand Shower Trim with VersaFlex Integral Diverter	S3694TRM	Chrome	789.05
• 2-1/2" x 4-1/2" HydroMersion hand shower wand with Total spray and push-button Pause mode	S3694STNTRM	Satin Nickel	1025.75
	S3694MBTRM	Matte Black	1201.85
	S3694BBZTRM	Brushed Bronze	1201.85
	<i>Trim Only with flow control spindle and cap nut: S16 Series Temptrol® valve required (see page 147)</i>		
• EverFlow rubber spray nozzles	S3694TRMTC	Chrome	866.55
• VersaFlex Integral Diverter lever	S3694STNTRMTC	Satin Nickel	1103.25
• 6" non-diverter tub spout	S3694MBTRMTC	Matte Black	1279.35
• 30" hand shower slide bar	S3694BBZTRMTC	Brushed Bronze	1279.35
• 60" flexible metal hose			
• Metal handle			
• 2.0 gpm (7.6 L/min) flow rate			



	<i>Trim Only: S26 Series Temptrol® valve required (see page 147)</i>		
• Duro Shower and Hand Shower Trim with VersaFlex Integral Diverter	S3698TRM	Chrome	810.85
• 5" HydroMersion showerhead with Total spray	S3698STNTRM	Satin Nickel	1053.40
	S3698MBTRM	Matte Black	1117.95
• 2-1/2" x 4-1/2" HydroMersion hand shower wand with Total spray and push-button Pause mode	S3698BBZTRM	Brushed Bronze	1117.95
	<i>Trim Only with flow control spindle and cap nut: S16 Series Temptrol® valve required (see page 147)</i>		
	S3698TRMTC	Chrome	888.35
• EverFlow rubber spray nozzles	S3698STNTRMTC	Satin Nickel	1130.90
• VersaFlex Integral Diverter lever	S3698MBTRMTC	Matte Black	1195.45
• 30" hand shower slide bar	S3698BBZTRMTC	Brushed Bronze	1195.45
• 60" flexible metal hose			
• Metal handle			
• 2.0 gpm (7.6 L/min) flow rate			



Duro® Shower and Tub/Shower

	DESCRIPTION	MODEL	FINISH	PRICE	
	• Duro Shower and Hand Shower Trim	<i>Trim Only: 26 Series Temptrol® and 2DIV Series valves required (see pages 139 and 158)</i>			
	• 5" HydroMersion showerhead with Total spray	3695TRM	Chrome	1081.20	
	• 2-1/2" x 4-1/2" HydroMersion hand shower wand with Total spray and push-button Pause mode	3695STNTRM	Satin Nickel	1483.20	
		3695MBTRM	Matte Black	1577.90	
	3695BBZTRM	Brushed Bronze	1577.90		
	<i>Trim Only with flow control spindle and cap nut: 16 Series Temptrol® and 2DIV Series valves required (see pages 139 and 158)</i>				
	• Separate dual outlet diverter trim	3695TRMTC	Chrome	1158.70	
	• EverFlow rubber spray nozzles	3695STNTRMTC	Satin Nickel	1560.70	
	• 30" hand shower slide bar	3695MBTRMTC	Matte Black	1655.40	
	• 60" flexible metal hose	3695BBZTRMTC	Brushed Bronze	1655.40	
• Metal handle					
• 2.0 gpm (7.6 L/min) flow rate					
					
	• Duro Shower System Trim	<i>Trim Only: 26 Series Temptrol® and 3DIV Series valves required (see pages 139 and 158)</i>			
	• 5" HydroMersion showerhead with Total spray	3696TRM	Chrome	1143.65	
	• 2-1/2" x 4-1/2" HydroMersion hand shower wand with Total spray and push-button Pause mode	3696STNTRM	Satin Nickel	1524.85	
		3696MBTRM	Matte Black	1610.05	
	3696BBZTRM	Brushed Bronze	1610.05		
	<i>Trim Only with flow control spindle and cap nut: 16 Series Temptrol® and 3DIV Series valves required (see pages 139 and 158)</i>				
	• EverFlow rubber spray nozzles	3696TRMTC	Chrome	1221.15	
	• Separate triple outlet diverter trim	3696STNTRMTC	Satin Nickel	1602.35	
	• 30" hand shower slide bar	3696MBTRMTC	Matte Black	1687.55	
	• 60" flexible metal hose	3696BBZTRMTC	Brushed Bronze	1687.55	
• 6" non-diverter tub spout					
• Metal handle					
• 2.0 gpm (7.6 L/min) flow rate					
					
	• Duro Shower Valve Trim with VersaFlex Integral Diverter/Volume Control	<i>Trim Only: S26 Series Temptrol® valve required (see pages 147 and 151)</i>			
	• VersaFlex Integral Diverter/Volume Control lever	S3690TRM	Chrome	274.55	
	• VersaFlex Integral Diverter/Volume Control lever	S3690STNTRM	Satin Nickel	389.15	
		S3690MBTRM	Matte Black	405.10	
	S3690BBZTRM	Brushed Bronze	405.10		
	<i>Trim Only with flow control spindle and cap nut: S16 Series Temptrol® valve required (see pages 147 and 151)</i>				
	• Metal handle	S3690TRMTC	Chrome	352.05	
		S3690STNTRMTC	Satin Nickel	466.65	
	S3690MBTRMTC	Matte Black	482.60		
	S3690BBZTRMTC	Brushed Bronze	482.60		
					

Duro® Shower and Tub/Shower



DESCRIPTION

- Duro Shower Valve Trim
- Metal handle



MODEL

FINISH

PRICE

Trim Only: 26 Series Temptrol® valve required (see page 139)

3690TRM	Chrome	261.05
3690STNTRM	Satin Nickel	347.60
3690MBTRM	Matte Black	367.50
3690BBZTRM	Brushed Bronze	367.50

Trim Only with flow control spindle and cap nut: 16 Series Temptrol® valve required (see page 139)

3690TRMTC	Chrome	338.55
3690STNTRMTC	Satin Nickel	425.10
3690MBTRMTC	Matte Black	445.00
3690BBZTRMTC	Brushed Bronze	445.00

Modifications for Duro Shower and Tub/Shower Systems

SUFFIX	DESCRIPTION	CHROME	STN	BBZ	MB
15	 1.5 gpm (5.7 L/min) flow restrictor	N/A	N/A	N/A	N/A
L1	Less showerhead	-39.35	-51.10	-55.10	-55.10
L2	Less hand shower	-58.20	-75.70	-81.55	-81.55
L3	Less showerhead and hand shower	-97.55	-126.80	-136.00	-136.60
L4	Less showerhead, arm and flange	-81.20	-105.45	-113.65	-113.65
L5	Less hand shower system	-201.20	-261.40	-281.65	-281.65
L6	Less tub spout (for non diverter tub spout, deduct this line)	-61.20	-79.55	-85.70	-85.70
L7	Less handle	-57.90	-73.25	-80.95	80.95

Duro® Shower and Tub/Shower Accessories

DESCRIPTION	MODEL	FINISH	PRICE
 <ul style="list-style-type: none"> • Single-Function Showerhead • Standard on the Duro collection • 5" square • HydroMersion technology for increased force • EverFlow rubber spray nozzles • Total spray for complete coverage • Solid brass ball joint • Contemporary/Modern style 	<i>2.0 gpm (7.6 L/min) standard</i>		
	482SHSQ	Chrome	98.35
	482SHSQSTN	Satin Nickel	127.45
	482SHSQMB	Matte Black	138.30
	482SHSQBBZ	Brushed Bronze	138.30
	<i>1.5 gpm (5.7 L/min) WaterSense®, CALGreen</i>		
	482SHSQ15	Chrome	98.35
	482SHSQSTN15	Satin Nickel	127.45
	482SHSQMB15	Matte Black	138.30
	482SHSQBBZ15	Brushed Bronze	138.30



 <ul style="list-style-type: none"> • Single-Function Showerhead • 8" square • HydroMersion technology for increased force • EverFlow rubber spray nozzles • Total spray for complete coverage • Solid brass ball joint • Contemporary/Modern style 	<i>2.0 gpm (7.6 L/min) standard</i>		
	682SHSQ	Chrome	209.25
	682SHSQSTN	Satin Nickel	272.00
	682SHSQMB	Matte Black	292.95
	682SHSQBBZ	Brushed Bronze	292.95
	<i>1.5 gpm (5.7 L/min) CALGreen</i>		
	682SHSQ15	Chrome	209.25
	682SHSQSTN15	Satin Nickel	272.00
	682SHSQMB15	Matte Black	292.95
	682SHSQBBZ15	Brushed Bronze	292.95



 <ul style="list-style-type: none"> • Single-Function Hand Shower Wand • Standard on the Duro and Verity collections • 2-1/2" x 4-1/2" spray head • HydroMersion technology for increased force • EverFlow rubber spray nozzles • Total spray for complete coverage • Push-button Pause mode for non-positive shutoff • Contemporary/Modern style 	<i>2.0 gpm (7.6 L/min) standard</i>		
	482WSQ	Chrome	145.50
	482WSQSTN	Satin Nickel	189.20
	482WSQMB	Matte Black	203.80
	482WSQBBZ	Brushed Bronze	203.80
	<i>1.5 gpm (5.7 L/min) WaterSense®, CALGreen</i>		
	482WSQ15	Chrome	145.50
	482WSQSTN15	Satin Nickel	189.20
	482WSQMB15	Matte Black	203.80
	482WSQBBZ15	Brushed Bronze	203.80



Duro® Shower and Tub/Shower Accessories



DESCRIPTION	MODEL	FINISH	PRICE
• Single-Function Hand Shower Slide Bar System	HS521	Chrome	502.85
	HS521STN	Satin Nickel	653.70
• Coordinates with Duro and Verity collections	HS521MB	Matte Black	703.95
	HS521BBZ	Brushed Bronze	703.95
• 2-1/2" x 4-1/2" HydroMersion hand shower wand with Total spray and push-button Pause mode			
• EverFlow rubber spray nozzles			
• 30" hand shower slide bar			
• 60" flexible metal hose			
• Contemporary/Modern style			
• 2.0 gpm (7.6 L/min) flow rate			



DESCRIPTION	MODEL	FINISH	PRICE
• 24" or 36" Slide/Grab Bar	<i>24" Length</i>		
• 2-1/2" x 4-1/2" HydroMersion hand shower wand with Total spray and push-button Pause mode	H36924	Chrome	586.05
	H36924STN	Satin Nickel	770.25
	H36924MB	Matte Black	820.55
• EverFlow rubber spray nozzles	<i>36" Length</i>		
• 60" flexible metal hose	H36936	Chrome	598.05
• 1-1/2" diameter slide bar	H36936STN	Satin Nickel	787.05
• ADA slide mechanism	H36936MB	Matte Black	837.20
• Wall elbow included			
• Contemporary/Modern style			
• 2.0 gpm (7.6 L/min) flow rate			







• Exposed Shower Riser	36EX	Chrome	718.55
• Square flanges	36EX-STN	Satin Nickel	1006.05
• Metal lever handle			
• Diverter included for toggling between distinct showerhead and hand shower positions			
• Includes column/slide bar and hand shower bracket			
• 60" flexible metal hose			
• Hand shower and showerhead not included			



• Shower Arm and Flange	300SQ	Chrome	92.35
• Standard on Duro and Verity collections	300SQ-STN	Satin Nickel	120.05
• Metal square flange	300SQ-MB	Matte Black	129.85
• 8" length	300SQ-BBZ	Brushed Bronze	129.85

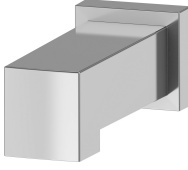
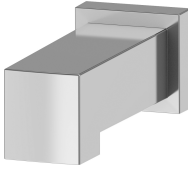







Duro® Shower and Tub/Shower Accessories

	DESCRIPTION	MODEL	FINISH	PRICE
	• Duro Non-Diverter Tub Spout	361TS	Chrome	232.40
	• 6" length	361TS-STN	Satin Nickel	302.15
	• Metal construction	361TS-MB	Matte Black	327.25
	• Thread-on installation	361TS-BBZ	Brushed Bronze	327.25
P				
	• Duro Non-Diverter Tub Spout	361TS-SS	Chrome	232.40
	• 6" length	361TS-SS-STN	Satin Nickel	302.15
	• Metal construction			
	• Slip-on installation			
P				
	• Duro Diverter Tub Spout	361DTS	Chrome	251.95
	• 6-1/2" length	361DTS-STN	Satin Nickel	327.55
	• Pull-up diverter	361DTS-MB	Matte Black	354.65
	• Metal construction	361DTS-BBZ	Brushed Bronze	354.65
P				
	• Duro Diverter Tub Spout	361DTS-SS	Chrome	251.95
	• 6-1/2" length	361DTS-SS-STN	Satin Nickel	327.55
	• Pull-up diverter			
	• Metal construction			
P				
	• Duro Diverter Valve Trim	<i>Trim Only: 2DIV-BODY or 3DIV-BODY required (see page 158)</i>		
	• 5" square	36-2DIV-TRM	Chrome	283.90
	• Metal handle	36-2DIV-STN-TRM	Satin Nickel	415.15
	• Screwless escutcheon	36-2DIV-MB-TRM	Matte Black	497.35
	• Dual or triple outlet	36-2DIV-BBZ-TRM	Brushed Bronze	497.35
P 				







Modifications for Duro Shower and Tub/Shower Accessories

SUFFIX	DESCRIPTION	CHROME	STN	BBZ	MB
15	 1.5 gpm (5.7 L/min) flow restrictor	N/A	N/A	N/A	N/A

Duro® Bath Accessories

	DESCRIPTION	MODEL	FINISH	PRICE
	<ul style="list-style-type: none"> • 18" or 24" Towel Bar • Coordinates with the Duro collection • Durable mounting system • Metal construction 	<i>18" Length</i>		
		363TB-18	Chrome	121.45
		363TB-18-STN	Satin Nickel	157.90
		363TB-18-MB	Matte Black	171.00
		363TB-18-BBZ	Brushed Bronze	171.00
		<i>24" Length</i>		
		363TB-24	Chrome	140.60
		363TB-24-STN	Satin Nickel	182.80
		363TB-24-MB	Matte Black	197.85
		363TB-24-BBZ	Brushed Bronze	197.85
	<ul style="list-style-type: none"> • 18" or 24" Double Towel Bar • Coordinates with the Duro collection • Durable mounting system • Metal construction 	<i>18" Length</i>		
		363DTB-18	Chrome	160.95
		363DTB-18-STN	Satin Nickel	209.15
		<i>24" Length</i>		
		363DTB-24	Chrome	188.45
		363DTB-24-STN	Satin Nickel	245.00
	<ul style="list-style-type: none"> • 18" or 24" Towel Bar with Assist Bar • Coordinates with the Duro collection • Durable mounting system • Metal construction • Screwless flanges • ADA compliant 	<i>18" Length</i>		
		363GBTB-18	Chrome	181.00
		363GBTB-18-STN	Satin Nickel	253.60
		<i>24" Length</i>		
		363GBTB-24	Chrome	201.15
		363GBTB-24-STN	Satin Nickel	281.60
	<ul style="list-style-type: none"> • 22" towel shelf with bar • Coordinates with the Duro collection • Durable mounting system • Metal construction 	363TS-22	Chrome	409.05
		363TS-22-STN	Satin Nickel	531.85
		<i>24" Length</i>		
		363TS-24	Chrome	409.05
	<ul style="list-style-type: none"> • Robe Hook • Coordinates with the Duro collection • Durable mounting system • Metal construction 	363RH	Chrome	36.65
		363RH-STN	Satin Nickel	47.65
		363RH-MB	Matte Black	51.60
		363RH-BBZ	Brushed Bronze	51.60
		<i>24" Length</i>		
	<ul style="list-style-type: none"> • Towel Holder • Coordinates with the Duro collection • Durable mounting system • Metal construction 	363TR	Chrome	122.25
		363TR-STN	Satin Nickel	158.90
		363TR-MB	Matte Black	172.20
		363TR-BBZ	Brushed Bronze	172.20
		<i>24" Length</i>		

Duro® Bath Accessories

	DESCRIPTION	MODEL	FINISH	PRICE
	• Toilet Paper Holder	363TP	Chrome	69.25
	• Coordinates with the Duro collection	363TP-STN	Satin Nickel	89.95
	• Durable mounting system	363TP-MB	Matte Black	97.50
	• Metal construction	363TP-BBZ	Brushed Bronze	97.50
	P			
	• Toilet Paper Holder	0113-TP	Chrome	106.05
	• Coordinates with the Duro collection			
	• Durable mounting system			
	• Metal construction			
	P			
	• Toilet Paper Holder with Assist Bar	363GBTP	Chrome	182.90
	• Coordinates with the Duro collection	363GBTP-STN	Satin Nickel	255.95
	• Durable mounting system			
	• Metal construction			
	• Screwless flanges			
	• ADA compliant			
	P 			
	• Corner Soap Basket	363-SD2	Chrome	176.25
	• Durable mounting system			
	• Metal construction			
	P			
	• Grab Bar	<i>12" Length</i>		
	• Coordinates with the Duro collection	363GB-12	Chrome	193.65
	• Metal construction	363GB-12-STN	Satin Nickel	271.20
	• Durable mounting system	<i>18" Length</i>		
	• Screwless flanges	363GB-18	Chrome	215.20
	• ADA compliant	363GB-18-STN	Satin Nickel	301.25
		<i>24" Length</i>		
		363GB-24	Chrome	239.20
		363GB-24-STN	Satin Nickel	335.00
		<i>36" Length</i>		
		363GB-36	Chrome	251.20
		363GB-36-STN	Satin Nickel	351.70
		<i>42" Length</i>		
		363GB-42	Chrome	263.65
	363GB-42-STN	Satin Nickel	369.20	
	P 			

Duro® Kitchen Faucet



DESCRIPTION	MODEL	FINISH	PRICE
• Duro Pull-Out Kitchen Faucet	SK3610PO	Chrome	604.90
• Single-hole mount	SK3610STSP0	Stainless Steel	846.80
• Ceramic cartridge	SK3610MBPO	Matte Black	846.80
• Braided hose connections	SK3610BBZPO	Brushed Bronze	846.80
• Pull-out spray spout			
• 1.5 gpm (5.7 L/min) standard			



Elm® Collection

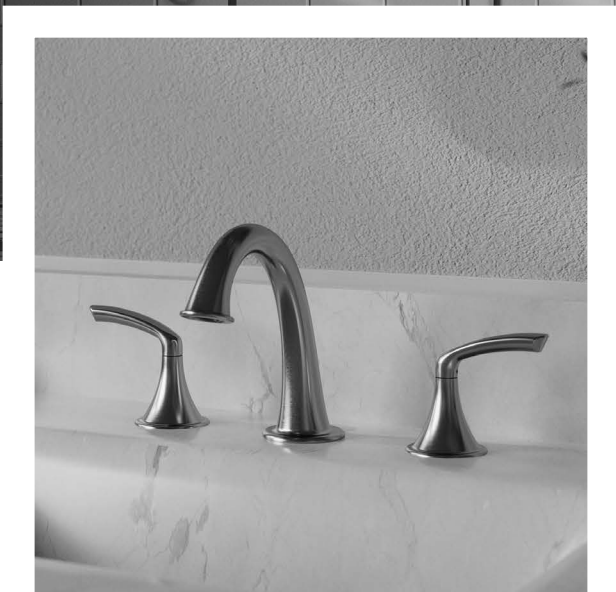

The sleek form and simple lines of the Symmons Elm Collection can be a subtle addition, or choose a bold finish to make it the focal point of any bathroom design.

Available in these finishes:

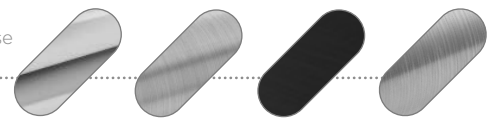

Polished
Chrome

Satin Nickel
Radiance® PVD
(STN)

Matte
Black
(MB)

Brushed Bronze
Radiance® PVD
(BBZ)

Faucets • Tub/Showers • Accessories









Elm® Lavatory Faucets and Tub Filler

	DESCRIPTION	MODEL	FINISH	PRICE
	• Elm Single Handle Lavatory Faucet	SLS5512PP	Chrome	421.50
	• Single-hole installation	SLS5512STNPP	Satin Nickel	550.75
	• 3/8" braided hose connections	SLS5512MBPP	Matte Black	590.05
	• Ceramic cartridges	SLS5512BBZPP	Brushed Bronze	590.05
	• Metal construction • Metal push-pop drain assembly included • 1.0 gpm (3.8 L/min) flow rate			
	WS P  LF			
	• Elm Centerset Lavatory Faucet	SLC5512PP	Chrome	307.25
	• 3-hole installation with 4" center	SLC5512STNPP	Satin Nickel	402.50
	• 1/2" IPS connections	SLC5512MBPP	Matte Black	430.20
	• Ceramic cartridges	SLC5512BBZPP	Brushed Bronze	430.20
	• Solid brass construction • Metal push-pop drain assembly included • 1.0 gpm (3.8 L/min) flow rate			
	WS P  LF			
	• Elm Widespread Lavatory Faucet	SLW5512PP	Chrome	529.65
	• 3-hole installation with 8-16" center	SLW5512STNPP	Satin Nickel	694.80
	• Threadless valve-to-spout connections	SLW5512MBPP	Matte Black	741.55
	• 3/8" braided hose connections	SLW5512BBZPP	Brushed Bronze	741.55
	• Ceramic cartridges • Metal push-pop drain assembly included • 1.0 gpm (3.8 L/min) flow rate			
	WS P  LF			
	• Elm Two Handle Roman Tub Faucet	SRT-5570	Chrome	773.00
	• Ceramic cartridges	SRT-5570-STN	Satin Nickel	1006.30
	• 1/2" rigid copper connections • Cast brass spout • Hand spray not included			
	P 			



Modifications for Elm Lavatory Faucets

SUFFIX	DESCRIPTION	CHROME	STN	BBZ	MB
05	CG 0.5 gpm (1.9 L/min) flow restrictor	N/A	N/A	N/A	N/A

Elm[®] Shower and Tub/Shower

	DESCRIPTION	MODEL	FINISH	PRICE
	<ul style="list-style-type: none"> • Elm Shower Valve Trim with VersaFlex Integral Diverter/Volume Control • 4" HydroMersion showerhead with 7 modes • EverFlow rubber spray nozzles • VersaFlex Integral Diverter/Volume Control lever • Metal handle • 2.0 gpm (7.6 L/min) flow rate 	<i>Trim Only: S26 Series Temptrol[®] valve required (see page 151)</i>		
		S5591TRM	Chrome	338.50
		S5591STNTRM	Satin Nickel	440.05
		S5591MBTRM	Matte Black	473.90
		S5591BBZTRM	Brushed Bronze	473.90
		<i>Trim Only with flow control spindle and cap nut: S16 Series Temptrol[®] valve required (see page 151)</i>		
		S5591TRMTC	Chrome	416.00
		S5591STNTRMTC	Satin Nickel	517.55
		S5591MBTRMTC	Matte Black	551.40
		S5591BBZTRMTC	Brushed Bronze	551.40
				
	<ul style="list-style-type: none"> • Elm Shower Trim • 4" HydroMersion showerhead with 7 modes • EverFlow rubber spray nozzles • Metal handle • 2.0 gpm (7.6 L/min) flow rate 	<i>Trim Only: 26 Series Temptrol[®] valve required (see page 139)</i>		
		5591TRM	Chrome	301.25
		5591STNTRM	Satin Nickel	391.65
		5591MBTRM	Matte Black	421.80
		5591BBZTRM	Brushed Bronze	421.80
		<i>Trim Only with flow control spindle and cap nut: 16 Series Temptrol[®] valve required (see page 139)</i>		
		5591TRMTC	Chrome	378.75
		5591STNTRMTC	Satin Nickel	469.15
		5591MBTRMTC	Matte Black	499.30
		5591BBZTRMTC	Brushed Bronze	499.30
				
	<ul style="list-style-type: none"> • Elm Tub and Shower Trim with VersaFlex Integral Diverter • 4" HydroMersion showerhead with 7 modes • EverFlow rubber spray nozzles • 5-7/8" non-diverter tub spout • Metal handle • 2.0 gpm (7.6 L/min) flow rate 	<i>Trim Only: S26 Series Temptrol[®] valve required (see page 147)</i>		
		S5592TRM	Chrome	381.30
		S5592STNTRM	Satin Nickel	495.65
		S5592MBTRM	Matte Black	533.80
		S5592BBZTRM	Brushed Bronze	533.80
		<i>Trim Only with flow control spindle and cap nut: S16 Series Temptrol[®] valve required (see page 147)</i>		
		S5592TRMTC	Chrome	458.80
		S5592STNTRMTC	Satin Nickel	573.15
		S5592MBTRMTC	Matte Black	611.30
		S5592BBZTRMTC	Brushed Bronze	611.30
				
	<ul style="list-style-type: none"> • Elm Tub and Shower Trim • 4" HydroMersion showerhead with 7 modes • EverFlow rubber spray nozzles • 5-7/8" diverter tub spout • Metal handle • 2.0 gpm (7.6 L/min) flow rate 	<i>Trim Only: 26 Series Temptrol[®] valve required (see page 139)</i>		
		5592TRM	Chrome	341.60
		5592STNTRM	Satin Nickel	444.10
		5592MBTRM	Matte Black	478.25
		5592BBZTRM	Brushed Bronze	478.25
		<i>Trim Only with flow control spindle and cap nut: 16 Series Temptrol[®] valve required (see page 139)</i>		
		5592TRMTC	Chrome	419.10
		5592STNTRMTC	Satin Nickel	521.60
		5592MBTRMTC	Matte Black	555.75
		5592BBZTRMTC	Brushed Bronze	555.75
				

Elm® Shower and Tub/Shower

	DESCRIPTION	MODEL	FINISH	PRICE
	• Elm Hand Shower Trim	<i>Trim Only: 26 Series Temptrol® valve required (see page 139)</i>		
	• 4" HydroMersion hand shower wand with 7 modes	5593TRM	Chrome	653.55
		5593STNTRM	Satin Nickel	849.65
	• EverFlow rubber spray nozzles	5593MBTRM	Matte Black	914.90
	• Cradle for hand shower wand	5593BBZTRM	Brushed Bronze	914.90
	• 60" flexible metal hose	<i>Trim Only with flow control spindle and cap nut: 16 Series Temptrol® valve required (see page 139)</i>		
	• Metal lever handle	5593TRMTC	Chrome	731.05
	• 2.0 gpm (7.6 L/min) flow rate	5593STNTRMTC	Satin Nickel	927.15
		5593MBTRMTC	Matte Black	992.40
		5593BBZTRMTC	Brushed Bronze	992.40
	WS P			
	• Elm Tub and Hand Shower Trim with VersaFlex Integral Diverter	<i>Trim Only: S26 Series Temptrol® valve required (see page 147)</i>		
	• 4" HydroMersion hand shower wand with 7 modes	S5594TRM	Chrome	693.20
		S5594STNTRM	Satin Nickel	901.15
		S5594MBTRM	Matte Black	970.40
	• EverFlow rubber spray nozzles	S5594BBZTRM	Brushed Bronze	970.40
	• 5-7/8" non-diverter tub spout	<i>Trim Only with flow control spindle and cap nut: S16 Series Temptrol® valve required (see page 147)</i>		
	• Cradle for hand shower wand	S5594TRMTC	Chrome	770.70
	• 60" flexible metal hose	S5594STNTRMTC	Satin Nickel	978.65
	• VersaFlex Integral Diverter lever	S5594MBTRMTC	Matte Black	1047.90
	• Metal handle	S5594BBZTRMTC	Brushed Bronze	1047.90
• 2.0 gpm (7.6 L/min) flow rate				
	WS P			
	• Elm Shower and Hand Shower Trim with VersaFlex Integral Diverter	<i>Trim Only: S26 Series Temptrol® valve required (see page 147)</i>		
	• 4" HydroMersion showerhead and hand shower wand with 7 modes	S5598TRM	Chrome	604.25
		S5598STNTRM	Satin Nickel	785.50
		S5598MBTRM	Matte Black	845.95
	• EverFlow rubber spray nozzles	S5598BBZTRM	Brushed Bronze	845.95
	• Cradle for hand shower wand	<i>Trim Only with flow control spindle and cap nut: S16 Series Temptrol® valve required (see page 147)</i>		
	• 60" flexible metal hose	S5598TRMTC	Chrome	681.75
	• VersaFlex Integral Diverter lever	S5598STNTRMTC	Satin Nickel	863.00
	• Metal handle	S5598MBTRMTC	Matte Black	923.45
	• 2.0 gpm (7.6 L/min) flow rate	S5598BBZTRMTC	Brushed Bronze	923.45
	WS P			

Elm® Shower and Tub/Shower

DESCRIPTION	MODEL	FINISH	PRICE
 <ul style="list-style-type: none"> • Elm Shower and Hand Shower Trim • 4" HydroMersion showerhead and hand shower wand with 7 modes • EverFlow rubber spray nozzles • Separate dual outlet diverter trim • Cradle for hand shower wand • 60" flexible metal hose • Metal handle • 2.0 gpm (7.6 L/min) flow rate • Matte Black and Brushed Bronze finishes are Special Order 	<i>Trim Only: 26 Series Temptrol® and 2DIV Series valves required (see pages 139 and 158)</i>		
	5595TRM	Chrome	891.15
	5595STNTRM	Satin Nickel	1158.45
	5595MBTRM	Matte Black	1248.40
	5595BBZTRM	Brushed Bronze	1248.40
	<i>Trim Only with flow control spindle and cap nut: 16 Series Temptrol® and 2DIV Series valves required (see pages 139 and 158)</i>		
	5595TRMTC	Chrome	968.65
	5595STNTRMTC	Satin Nickel	1235.95
	5595MBTRMTC	Matte Black	1325.90
	5595BBZTRMTC	Brushed Bronze	1325.90



 <ul style="list-style-type: none"> • Elm Shower System Trim • 4" HydroMersion showerhead and hand shower wand with 7 modes • EverFlow rubber spray nozzles • Separate triple outlet diverter trim • Cradle for hand shower wand • 60" flexible metal hose • 5-7/8" non-diverter tub spout • Metal handle • 2.0 gpm (7.6 L/min) flow rate • Matte Black and Brushed Bronze finishes are Special Order 	<i>Trim Only: 26 Series Temptrol® and 3DIV Series valves required (see pages 139 and 158)</i>		
	5596TRM	Chrome	896.10
	5596STNTRM	Satin Nickel	1164.95
	5596MBTRM	Matte Black	1254.65
	5596BBZTRM	Brushed Bronze	1254.65
	<i>Trim Only with flow control spindle and cap nut: 16 Series Temptrol® and 3DIV Series valves required (see pages 139 and 158)</i>		
	5596TRMTC	Chrome	973.60
	5596STNTRMTC	Satin Nickel	1242.45
	5596MBTRMTC	Matte Black	1332.15
	5596BBZTRMTC	Brushed Bronze	1332.15



 <ul style="list-style-type: none"> • Elm Shower Valve Trim with VersaFlex Integral Diverter/Volume Control • Metal handle • VersaFlex Integral Diverter/Volume Control lever 	<i>Trim Only: S26 Series Temptrol® valve required (see pages 147 and 151)</i>		
	S5590TRM	Chrome	248.75
	S5590STNTRM	Satin Nickel	323.35
	S5590MBTRM	Matte Black	348.30
	S5590BBZTRM	Brushed Bronze	348.30
	<i>Trim Only with flow control spindle and cap nut: S16 Series Temptrol® valve required (see pages 147 and 151)</i>		
	S5590TRMTC	Chrome	326.25
	S5590STNTRMTC	Satin Nickel	400.85
	S5590MBTRMTC	Matte Black	425.80
	S5590BBZTRMTC	Brushed Bronze	425.80



 <ul style="list-style-type: none"> • Elm Shower Valve Trim • Metal handle 	<i>Trim Only: 26 Series Temptrol® valve required (see page 139)</i>		
	5590TRM	Chrome	236.00
	5590STNTRM	Satin Nickel	306.70
	5590MBTRM	Matte Black	330.35
	5590BBZTRM	Brushed Bronze	330.35
	<i>Trim Only with flow control spindle and cap nut: 16 Series Temptrol® valve required (see page 139)</i>		
	5590TRMTC	Chrome	313.50
	5590STNTRMTC	Satin Nickel	384.20
	5590MBTRMTC	Matte Black	407.85
	5590BBZTRMTC	Brushed Bronze	407.85



Modifications for Elm Shower and Tub/Shower Systems

SUFFIX	DESCRIPTION	CHROME	STN	BBZ	MB
15	 1.5 gpm (5.7 L/min) flow restrictor	N/A	N/A	N/A	N/A
L1	Less showerhead	-43.60	-56.80	-61.05	N/A
L2	Less hand shower	-45.20	-58.70	-63.25	N/A
L3	Less showerhead and hand shower	-88.80	-115.45	-124.30	N/A
L4	Less showerhead, arm and flange	-57.80	-75.15	-75.15	N/A
L5	Less hand shower system	-186.90	-243.00	-261.70	N/A
L6	Less tub spout (for non diverter tub spout, deduct this line)	-51.05	-69.05	-71.75	N/A
L6.	Less tub spout (for diverter tub spout, deduct this line)	-52.95	-71.75	-74.15	N/A
L7	Less handle	-19.30	-25.10	-27.05	N/A

Elm® Shower and Tub/Shower Accessories

DESCRIPTION	MODEL	FINISH	PRICE
 <ul style="list-style-type: none"> • Multifunction Showerhead • Standard on the Elm collection • 4" diameter • 7 modes • HydroMersion technology for increased force • EverFlow rubber spray nozzles • Easy-shift thumb lever • Solid brass ball joint • Transitional style 	<i>2.0 gpm (7.6 L/min) standard</i>		
	592SH7	Chrome	109.05
	592SH7STN	Satin Nickel	141.80
	592SH7MB	Matte Black	153.70
	592SH7BBZ	Brushed Bronze	153.70
	<i>1.5 gpm (5.7 L/min) WaterSense®, CALGreen</i>		
	592SH715	Chrome	109.05
	592SH7STN15	Satin Nickel	141.80
	592SH7MB15	Matte Black	153.70
	592SH7BBZ15	Brushed Bronze	153.70



 <ul style="list-style-type: none"> • Multifunction Hand Shower Wand • Standard on the Elm collection • 4" diameter • 7 modes • HydroMersion technology for increased force • EverFlow rubber spray nozzles • Easy-shift thumb lever • Pause mode for non-positive shutoff • Transitional style 	<i>2.0 gpm (7.6 L/min) standard</i>		
	592W7	Chrome	112.90
	592W7STN	Satin Nickel	146.80
	592W7MB	Matte Black	158.05
	592W7BBZ	Brushed Bronze	158.05
	<i>1.5 gpm (5.7 L/min) WaterSense®</i>		
	592W715	Chrome	112.90
	592W7STN15	Satin Nickel	146.80
	592W7MB15	Matte Black	158.05
	592W7BBZ15	Brushed Bronze	158.05



 <ul style="list-style-type: none"> • Multifunction Hand Shower System • Standard on the Elm collection • 4" HydroMersion hand shower wand with 7 modes • EverFlow rubber spray nozzles • Wall cradle and elbow • 60" flexible metal hose • Transitional style • 2.0 gpm (7.6 L/min) flow rate 	HR607	Chrome	467.25
	HR607STN	Satin Nickel	607.45
	HR607MB	Matte Black	654.20
	HR607BBZ	Brushed Bronze	654.20



 <ul style="list-style-type: none"> • Multifunction Hand Shower Slide Bar System • Coordinates with the Elm collection • 4" HydroMersion hand shower wand with 7 modes • EverFlow rubber spray nozzles • 30" hand shower slide bar • 60" flexible metal hose • Transitional style • 2.0 gpm (7.6 L/min) flow rate 	HR627	Chrome	557.20
	HR627STN	Satin Nickel	724.35
	HR627MB	Matte Black	780.05
	HR627BBZ	Brushed Bronze	780.05



Elm® Shower and Tub/Shower Accessories

	DESCRIPTION	MODEL	FINISH	PRICE
	• 24" or 36" Slide/Grab Bar	<i>24" Length</i>		
	• Contemporary/Modern style	H35924	Chrome	586.05
	• 4" HydroMersion hand shower wand with 7 modes	H35924STN	Satin Nickel	770.25
		H35924MB	Matte Black	820.45
	• EverFlow rubber spray nozzles	<i>36" Length</i>		
	• 60" flexible metal hose	H35936	Chrome	598.05
	• 1-1/2" diameter slide bar	H35936STN	Satin Nickel	787.05
	• Pause mode for non-positive shutoff	H35936MB	Matte Black	834.55
	• ADA slide mechanism			
	• Wall elbow included			
• 2.0 gpm (7.6 L/min) flow rate				
<p>WS P </p>				
	• Exposed Shower Riser	35EX	Chrome	718.55
	• Round flanges	35EX-STN	Satin Nickel	1006.05
	• Metal lever handle	35EX-MB	Matte Black	1006.05
	• Diverter included for toggling between distinct showerhead and hand shower positions			
	• Includes column/slide bar and hand shower bracket			
	• 60" flexible metal hose			
	• Hand shower and showerhead not included			
<p>P </p>				
	• Short shower arm and flange	300S	Chrome	26.85
	• Stamped flange	300S-STN	Satin Nickel	40.30
	• 6" length	300S-MB	Matte Black	41.25
		300S-BBZ	Brushed Bronze	41.25
<p>P</p>				
	• Shower arm with heavy flange	300	Chrome	83.00
	• 8" length	300-STN	Satin Nickel	107.50
		300-MB	Matte Black	104.45
		300-BBZ	Brushed Bronze	104.45
<p>P</p>				
	• Elm Non-Diverter Tub Spout	552TS	Chrome	111.55
	• 5-7/8" length	552TS-STN	Satin Nickel	150.30
	• Metal construction	552TSMB	Matte Black	156.10
	• Thread-on installation	552TSBBZ	Brushed Bronze	156.10
<p>P</p>				

Elm[®] Shower and Tub/Shower Accessories



DESCRIPTION	MODEL	FINISH	PRICE
• Elm Diverter Tub Spout	552TSD	Chrome	115.60
• 5-7/8" length	552TSD-STN	Satin Nickel	155.85
• Pull-up diverter	552TSDMB	Matte Black	161.85
• Metal construction	552TSDBBZ	Brushed Bronze	161.85
• Thread-on installation			







DESCRIPTION	MODEL	FINISH	PRICE
• Elm Diverter Valve Trim	<i>Trim Only: 2DIV-BODY or 3DIV-BODY required (see page 158)</i>		
• 5" diameter	55-2DIV-TRM	Chrome	263.85
• Screwless escutcheon	55-2DIV-STN-TRM	Satin Nickel	385.15
• Dual or triple outlet	55DIVMBTRM	Matte Black	369.40
• Matte Black and Brushed Bronze finishes are Special Order	55DIVBBZTRM	Brushed Bronze	369.40



Modifications for Elm Shower and Tub/Shower Accessories

SUFFIX	DESCRIPTION	CHROME	STN	BBZ	MB
15	1.5 gpm (5.7 L/min) flow restrictor	N/A	N/A	N/A	N/A

	DESCRIPTION	MODEL	FINISH	PRICE
	<ul style="list-style-type: none"> • 18" or 24" Towel Bar • Coordinates with Birch and Elm collections • Durable mounting system • Metal construction 	<i>18" Length</i>		
		553TB-18	Chrome	86.70
		553TB-18-STN	Satin Nickel	125.55
		553TB18MB	Matte Black	121.40
		553TB18BBZ	Brushed Bronze	121.40
		<i>24" Length</i>		
		553TB-24	Chrome	95.20
		553TB-24-STN	Satin Nickel	137.90
		553TB24MB	Matte Black	133.20
		553TB24BBZ	Brushed Bronze	133.20
	<ul style="list-style-type: none"> • Double Robe Hook • Coordinates with Birch and Elm collections • Durable mounting system • Metal construction 	553RH	Chrome	46.40
		553RH-STN	Satin Nickel	67.05
		553RHMB	Matte Black	64.95
		553RHBBZ	Brushed Bronze	64.95
	<ul style="list-style-type: none"> • Towel Ring • Coordinates with Birch and Elm collections • Durable mounting system • Metal construction 	553TR	Chrome	57.95
		553TR-STN	Satin Nickel	84.05
		553TRMB	Matte Black	81.20
		553TRBBZ	Brushed Bronze	81.20
	<ul style="list-style-type: none"> • Toilet Paper Holder • Coordinates with Birch and Elm collections • Durable mounting system • Metal construction 	553TP	Chrome	95.20
		553TP-STN	Satin Nickel	137.90
		553TPMB	Matte Black	133.20
		553TPBBZ	Brushed Bronze	133.20

Identity® Collection



The Identity Collection balances sleek curves and defined edges with stylish simplicity. Its distinct contours bring a contemporary touch with hints of retro Space Age design.

Available in these finishes:

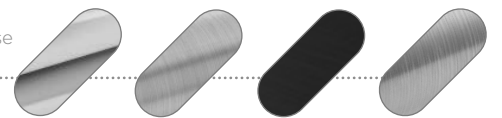

Polished
Chrome

Satin Nickel
Radiance® PVD
(STN)

Matte
Black
(MB)

Brushed Bronze
Radiance® PVD
(BBZ)

Faucets • Tub/Showers • Accessories

Identity® Lavatory Faucets



DESCRIPTION	MODEL	FINISH	PRICE
• Identity Single Handle Lavatory Faucet	SLS6712PP	Chrome	291.95
• Single-hole installation	SLS6712STNPP	Satin Nickel	408.65
• 3/8" braided hose connections	SLS6712MBPP	Matte Black	408.75
• Ceramic cartridges	SLS6712BBZPP	Brushed Bronze	408.70
• Metal construction			
• Metal push-pop drain assembly included			
• 1.0 gpm (3.8 L/min) flow rate			



• Identity Centerset Lavatory Faucet	SLC6712PP	Chrome	252.15
• 3-hole installation with 4" center	SLC6712STNPP	Satin Nickel	353.05
• 1/2" IPS connections			
• Ceramic cartridges			
• Solid brass construction			
• Metal push-pop drain assembly included			
• 1.0 gpm (3.8 L/min) flow rate			











• Identity Widespread Lavatory Faucet	SLW6712PP	Chrome	365.85
• 3-hole installation with 8-16" center	SLW6712STNPP	Satin Nickel	512.25
• Threadless valve-to-spout connections	SLW6712MBPP	Matte Black	512.25
• 3/8" braided hose connections	SLW6712BBZPP	Brushed Bronze	512.20
• Ceramic cartridges			
• Metal push-pop drain assembly included			
• 1.0 gpm (3.8 L/min) flow rate			





Modifications for Identity Lavatory Faucets

SUFFIX	DESCRIPTION	CHROME	STN	BBZ	MB
05	CR 0.5 gpm (1.9 L/min) flow restrictor	N/A	N/A	N/A	N/A

Identity® Shower and Tub/Shower

DESCRIPTION	MODEL	FINISH	PRICE
 <ul style="list-style-type: none"> • Identity Shower Trim with VersaFlex Integral Diverter/Volume Control • 4" HydroMersion showerhead with Total spray • EverFlow rubber spray nozzles • VersaFlex Integral Diverter/Volume Control lever • Metal handle • 2.0 gpm (7.6 L/min) flow rate 	<i>Trim Only: S26 Series Temptrol® valve required (see page 151)</i>		
	S6791TRM	Chrome	238.30
	S6791STNTRM	Satin Nickel	313.50
	S6791MBTRM	Matte Black	333.65
	S6791BBZTRM	Brushed Bronze	333.65
	<i>Trim Only with flow control spindle and cap nut: S16 Series Temptrol® valve required (see page 151)</i>		
	S6791TRMTC	Chrome	315.80
	S6791STNTRMTC	Satin Nickel	391.00
	S6791MBTRMTC	Matte Black	411.15
	S6791BBZTRMTC	Brushed Bronze	411.15
WS P 			
 <ul style="list-style-type: none"> • Identity Shower Trim • 4" HydroMersion showerhead with Total spray • EverFlow rubber spray nozzles • Metal handle • 2.0 gpm (7.6 L/min) flow rate 	<i>Trim Only: 26 Series Temptrol® valve required (see page 139)</i>		
	6791TRM	Chrome	179.80
	6791STNTRM	Satin Nickel	228.55
	6791MBTRM	Matte Black	251.75
	6791BBZTRM	Brushed Bronze	251.75
	<i>Trim Only with flow control spindle and cap nut: 16 Series Temptrol® valve required (see page 139)</i>		
	6791TRMTC	Chrome	257.30
	6791STNTRMTC	Satin Nickel	306.05
	6791MBTRMTC	Matte Black	329.25
	6791BBZTRMTC	Brushed Bronze	329.25
WS P 			
 <ul style="list-style-type: none"> • Identity Tub and Shower Trim with VersaFlex Integral Diverter • 4" HydroMersion showerhead with Total spray • EverFlow rubber spray nozzles • VersaFlex Integral Diverter lever • 5-1/2" non-diverter tub spout • Metal handle • 2.0 gpm (7.6 L/min) flow rate 	<i>Trim Only: S26 Series Temptrol® valve required (see page 147)</i>		
	S6792TRM	Chrome	257.70
	S6792STNTRM	Satin Nickel	340.75
	S6792MBTRM	Matte Black	360.80
	S6792BBZTRM	Brushed Bronze	360.80
	<i>Trim Only with flow control spindle and cap nut: S16 Series Temptrol® valve required (see page 147)</i>		
	S6792TRMTC	Chrome	335.20
	S6792STNTRMTC	Satin Nickel	418.25
	S6792MBTRMTC	Matte Black	438.30
	S6792BBZTRMTC	Brushed Bronze	438.30
WS P 			
 <ul style="list-style-type: none"> • Identity Tub and Shower Trim • 4" HydroMersion showerhead with Total spray • EverFlow rubber spray nozzles • 5-1/2" diverter tub spout • Metal handle • 2.0 gpm (7.6 L/min) flow rate 	<i>Trim Only: 26 Series Temptrol® valve required (see page 139)</i>		
	6792TRM	Chrome	190.25
	6792STNTRM	Satin Nickel	245.60
	6792MBTRM	Matte Black	266.35
	6792BBZTRM	Brushed Bronze	266.35
	<i>Trim Only with flow control spindle and cap nut: 16 Series Temptrol® valve required (see page 139)</i>		
	6792TRMTC	Chrome	267.75
	6792STNTRMTC	Satin Nickel	323.10
	6792MBTRMTC	Matte Black	343.85
	6792BBZTRMTC	Brushed Bronze	343.85
WS P 			

Identity® Shower and Tub/Shower

	DESCRIPTION	MODEL	FINISH	PRICE
	• Identity Hand Shower Trim	<i>Trim Only: 26 Series Temptrol® valve required (see page 139)</i>		
	• 4" HydroMersion hand shower wand with Total spray and Pause mode	6793TRM	Chrome	469.20
	• EverFlow rubber spray nozzles	6793STNTRM	Satin Nickel	636.25
	• Cradle for hand shower wand	6793MBTRM	Matte Black	777.20
	• 60" flexible metal hose	6793BBZTRM	Brushed Bronze	777.20
	• Metal lever handle	<i>Trim Only with flow control spindle and cap nut: 16 Series Temptrol® valve required (see page 139)</i>		
	• 2.0 gpm (7.6 L/min) flow rate	6793TRMTC	Chrome	546.70
		6793STNTRMTC	Satin Nickel	713.75
		6793MBTRMTC	Matte Black	854.70
		6793BBZTRMTC	Brushed Bronze	854.70
WS P				
	• Identity Tub and Hand Shower Trim with VersaFlex Integral Diverter	<i>Trim Only: S26 Series Temptrol® valve required (see page 147)</i>		
	• 4" HydroMersion hand shower wand with Total spray and Pause mode	S6794TRM	Chrome	537.55
	• EverFlow rubber spray nozzles	S6794STNTRM	Satin Nickel	823.60
	• VersaFlex Integral Diverter lever	S6794MBTRM	Matte Black	886.95
	• 5-1/2" non-diverter tub spout	S6794BBZTRM	Brushed Bronze	886.95
	• Cradle for hand shower wand	<i>Trim Only with flow control spindle and cap nut: S16 Series Temptrol® valve required (see page 147)</i>		
	• 60" flexible metal hose	S6794TRMTC	Chrome	615.05
	• Metal handle	S6794STNTRMTC	Satin Nickel	901.10
	• 2.0 gpm (7.6 L/min) flow rate	S6794MBTRMTC	Matte Black	964.45
		S6794BBZTRMTC	Brushed Bronze	964.45
WS P				
	• Identity Shower and Hand Shower Trim with VersaFlex Integral Diverter	<i>Trim Only: S26 Series Temptrol® valve required (see page 147)</i>		
	• 4" HydroMersion showerhead with Total spray	S6798TRM	Chrome	502.35
	• 4" HydroMersion hand shower wand with Total spray and Pause mode	S6798STNTRM	Satin Nickel	683.95
	• EverFlow rubber spray nozzles	S6798MBTRM	Matte Black	703.25
	• VersaFlex Integral Diverter lever	S6798BBZTRM	Brushed Bronze	703.25
	• Cradle for hand shower wand	<i>Trim Only with flow control spindle and cap nut: S16 Series Temptrol® valve required (see page 147)</i>		
	• 60" flexible metal hose	S6798TRMTC	Chrome	579.85
	• Metal handle	S6798STNTRMTC	Satin Nickel	761.45
	• 2.0 gpm (7.6 L/min) flow rate	S6798MBTRMTC	Matte Black	780.75
		S6798BBZTRMTC	Brushed Bronze	780.75
WS P				

Identity® Shower and Tub/Shower

DESCRIPTION	MODEL	FINISH	PRICE
<i>Trim Only: 26 Series Temptrol® and 2DIV Series valves required (see pages 139 and 158)</i>			
<ul style="list-style-type: none"> • Identity Shower and Hand Shower Trim • 4" HydroMersion showerhead with Total spray • 4" HydroMersion hand shower wand with Total spray and Pause mode • Separate dual outlet diverter trim • EverFlow rubber spray nozzles • Cradle for hand shower wand • 60" flexible metal hose • Metal handle • 2.0 gpm (7.6 L/min) flow rate 	6795TRM	Chrome	654.45
	6795STNTRM	Satin Nickel	895.70
	6795MBTRM	Matte Black	916.35
	6795BBZTRM	Brushed Bronze	916.35
<i>Trim Only with flow control spindle and cap nut: 16 Series Temptrol® and 2DIV Series valves required (see pages 139 and 158)</i>			
	6795TRMTC	Chrome	731.95
	6795STNTRMTC	Satin Nickel	973.20
	6795MBTRMTC	Matte Black	993.85
	6795BBZTRMTC	Brushed Bronze	993.85



<i>Trim Only: 26 Series Temptrol® and 3DIV Series valves required (see pages 139 and 158)</i>			
<ul style="list-style-type: none"> • Identity Shower System Trim • 4" HydroMersion showerhead with Total spray • 4" HydroMersion hand shower wand with Total spray and Pause mode • EverFlow rubber spray nozzles • Separate triple outlet diverter trim • Cradle for hand shower wand • 60" flexible metal hose • 5-1/2" non-diverter tub spout • Metal handle • 2.0 gpm (7.6 L/min) flow rate 	6796TRM	Chrome	662.65
	6796STNTRM	Satin Nickel	828.30
	6796MBTRM	Matte Black	927.70
	6796BBZTRM	Brushed Bronze	927.70
<i>Trim Only with flow control spindle and cap nut: 16 Series Temptrol® and 3DIV Series valves required (see pages 139 and 158)</i>			
	6796TRMTC	Chrome	740.15
	6796STNTRMTC	Satin Nickel	905.80
	6796MBTRMTC	Matte Black	1005.20
	6796BBZTRMTC	Brushed Bronze	1005.20



<i>Trim Only: S26 Series Temptrol® valve required (see pages 147 and 151)</i>			
<ul style="list-style-type: none"> • Identity Shower Valve Trim with VersaFlex Integral Diverter/Volume Control • VersaFlex Integral Diverter/Volume Control lever • Metal handle 	S6790TRM	Chrome	189.55
	S6790STNTRM	Satin Nickel	245.30
	S6790MBTRM	Matte Black	265.30
	S6790BBZTRM	Brushed Bronze	265.30
<i>Trim Only with flow control spindle and cap nut: S16 Series Temptrol® valve required (see pages 147 and 151)</i>			
	S6790TRMTC	Chrome	267.05
	S6790STNTRMTC	Satin Nickel	322.80
	S6790MBTRMTC	Matte Black	342.80
	S6790BBZTRMTC	Brushed Bronze	342.80



<i>Trim Only: 26 Series Temptrol® valve required (see page 139)</i>			
<ul style="list-style-type: none"> • Identity Shower Valve Trim • Metal handle 	6790TRM	Chrome	137.30
	6790STNTRM	Satin Nickel	171.70
	6790MBTRM	Matte Black	192.25
	6790BBZTRM	Brushed Bronze	192.25
<i>Trim Only with flow control spindle and cap nut: 16 Series Temptrol® valve required (see page 139)</i>			
	6790TRMTC	Chrome	214.80
	6790STNTRMTC	Satin Nickel	249.20
	6790MBTRMTC	Matte Black	269.75
	6790BBZTRMTC	Brushed Bronze	269.75



Modifications for Identity Shower and Tub/Shower Systems

SUFFIX	DESCRIPTION	CHROME	STN	BBZ	MB
15	 1.5 gpm (5.7 L/min) flow restrictor	N/A	N/A	N/A	N/A
L1	Less showerhead	-29.60	-38.50	-41.40	-41.40
L2	Less hand shower	-34.30	-44.60	-48.00	-48.00
L3	Less showerhead and hand shower	-64.70	-83.15	-89.50	-89.50
L4	Less showerhead, arm and flange	-43.80	-56.95	-62.05	-62.05
L5	Less hand shower system	-176.10	-228.90	-246.40	-246.40
L6	Less tub spout (for non diverter tub spout, deduct this line)	-15.00	-18.95	-21.05	-21.05
L6.	Less tub spout (for diverter tub spout, deduct this line)	-32.70	-42.45	-47.10	-47.10
L7	Less handle	-25.75	-33.45	-36.10	-36.10

Identity® Shower and Tub/Shower Accessories



DESCRIPTION	MODEL	FINISH	PRICE
<ul style="list-style-type: none"> • Single-Function Showerhead • Standard on the Identity collection • 4" diameter • HydroMersion technology for increased force • Total spray for complete coverage • EverFlow rubber spray nozzles • Solid brass ball joint • Contemporary/Modern style 	<i>2.0 gpm (7.6 L/min) standard</i>		
	482SH	Chrome	74.05
	482SHSTN	Satin Nickel	96.30
	482SHMB	Matte Black	103.60
	482SHBBZ	Brushed Bronze	103.60
	<i>1.5 gpm (5.7 L/min) WaterSense®, CALGreen</i>		
	482SH15	Chrome	74.05
	482SHSTN15	Satin Nickel	96.30
	482SHMB15	Matte Black	103.60
	482SHBBZ15	Brushed Bronze	103.60



<ul style="list-style-type: none"> • Single-Function Hand Shower Wand • Standard on the Identity collection • 4" diameter • HydroMersion technology for increased force • Total spray for complete coverage • Pause mode for non-positive shutoff • EverFlow rubber spray nozzles • Easy-shift thumb lever • Contemporary/Modern style 	<i>2.0 gpm (7.6 L/min) standard</i>		
	482W	Chrome	85.75
	482WSTN	Satin Nickel	111.45
	482WMB	Matte Black	120.05
	482WBBZ	Brushed Bronze	120.05
	<i>1.5 gpm (5.7 L/min) WaterSense®, CALGreen</i>		
	482W	Chrome	85.75
	482WSTN15	Satin Nickel	111.45
	482WMB15	Matte Black	120.05
	482WBBZ15	Brushed Bronze	120.05



<ul style="list-style-type: none"> • Single-Function Hand Shower System • Standard on the Identity collection • 4" HydroMersion hand shower wand with Total spray Pause mode • EverFlow rubber spray nozzles • Wall cradle and elbow • 60" flexible metal hose • Contemporary/Modern style • 2.0 gpm (7.6 L/min) flow rate 	HR501	Chrome	440.10
	HR501STN	Satin Nickel	572.15
	HR501MB	Matte Black	616.15
	HR501BBZ	Brushed Bronze	616.15









<ul style="list-style-type: none"> • Single-Function Hand Shower Slide Bar System • Coordinates with the Identity collection • 4" HydroMersion hand shower wand with Total spray and Pause mode • EverFlow rubber spray nozzles • 30" hand shower slide bar • 60" flexible metal hose • Contemporary/Modern style • 2.0 gpm (7.6 L/min) flow rate 	HR521	Chrome	530.05
	HR521STN	Satin Nickel	689.10
	HR521MB	Matte Black	742.05
	HR521BBZ	Brushed Bronze	742.05



Identity® Shower and Tub/Shower Accessories

	DESCRIPTION	MODEL	FINISH	PRICE
	<ul style="list-style-type: none"> • 24" or 36" Slide/Grab Bar • Contemporary/Modern style • 4" HydroMersion hand shower wand with 7 modes • EverFlow rubber spray nozzles • 60" flexible metal hose • 1-1/2" diameter slide bar • Pause mode for non-positive shutoff • ADA slide mechanism • Wall elbow included • 2.0 gpm (7.6 L/min) flow rate 	<i>24" Length</i> H35924 H35924STN H35924MB	Chrome Satin Nickel Matte Black	586.05 770.25 820.45
		<i>36" Length</i>		
		H35936	Chrome	598.05
		H35936STN	Satin Nickel	787.05
		H35936MB	Matte Black	834.55
	<ul style="list-style-type: none"> • Exposed Shower Riser • Round flanges • Metal lever handle • Diverter included for toggling between distinct showerhead and hand shower positions • Includes column/slide bar and hand shower bracket • 60" flexible metal hose • Hand shower and showerhead not included 	35EX 35EX-STN 35EX-MB	Chrome Satin Nickel Matte Black	718.55 1006.05 1006.05
	<ul style="list-style-type: none"> • Short shower arm and flange • Stamped flange • 6" length 	300S 300S-STN 300S-MB 300S-BBZ	Chrome Satin Nickel Matte Black Brushed Bronze	26.85 40.30 41.25 41.25
	<ul style="list-style-type: none"> • Non-diverter tub spout • 5-1/4" length • Metal construction • Thread-on installation 	060 060-STN 060MB 060BBZ	Chrome Satin Nickel Matte Black Brushed Bronze	32.70 49.60 52.55 52.50
	<ul style="list-style-type: none"> • Diverter tub spout • 5-1/2" length • Pull-up diverter • Metal construction • Thread-on installation 	054 054-STN 054MB 054BBZ	Chrome Satin Nickel Matte Black Brushed Bronze	73.50 106.15 114.35 114.35



Identity® Shower and Tub/Shower Accessories

	DESCRIPTION	MODEL	FINISH	PRICE
	• Non-diverter tub spout	061	Chrome	57.40
	• 5-1/4" length	061-STN	Satin Nickel	93.95
	• Diverter tub spout	053	Chrome	87.75
	• 5-1/2" length	053-STN	Satin Nickel	142.25
	• 1/2" inlet			
	• Pull-up diverter			
	• Metal construction			
	• Slip-on installation			
				
	• Identity Diverter Valve Trim	<i>Trim Only: 2DIV-BODY or 3DIV-BODY required (see page 158)</i>		
	• 5" diameter	67-DIV-TRM	Chrome	204.30
	• Metal handle	67-DIV-TRM-STN	Satin Nickel	285.45
	• Screwed escutcheon	67DIVTRMMB	Matte Black	286.05
	• Dual or triple outlet	67DIVTRMBBZ	Brushed Bronze	286.05
	 			

Modifications for Identity Shower and Tub/Shower Accessories

SUFFIX	DESCRIPTION	CHROME	STN	BBZ	MB
15	 1.5 gpm (5.7 L/min) flow restrictor	N/A	N/A	N/A	N/A

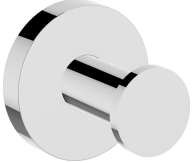
Identity® Bath Accessories

	DESCRIPTION	MODEL	FINISH	PRICE
	<ul style="list-style-type: none"> • 18" or 24" Towel Bar • Coordinates with the Identity collection • Durable mounting system • Metal construction 	<i>18" Length</i>		
		673TB-18	Chrome	44.70
		673TB-STN-18	Satin Nickel	62.45
		<i>24" Length</i>		
		673TB-24	Chrome	52.55
		673TB-STN-24	Satin Nickel	73.50
	<ul style="list-style-type: none"> • Robe Hook • Coordinates with the Identity collection • Durable mounting system • Metal construction 	673RH	Chrome	24.85
		673RH-STN	Satin Nickel	34.70
	<ul style="list-style-type: none"> • Towel Ring • Coordinates with the Identity collection • Durable mounting system • Metal construction 	673TR	Chrome	44.70
		673TR-STN	Satin Nickel	62.45
	<ul style="list-style-type: none"> • Toilet Paper Holder • Coordinates with the Identity collection • Durable mounting system • Metal construction 	673TP	Chrome	49.45
		673TP-STN	Satin Nickel	69.25

Identity® Kitchen Faucet



DESCRIPTION	MODEL	FINISH	PRICE
• Identity Single Handle Kitchen Faucet	SK6710PD	Chrome	432.80
• Single-hole mount	SK6710PDSTS	Stainless Steel	562.65
• Ceramic cartridge			
• Braided hose connections			
• Pull-down wand with 2-mode spray-to-stream control			
• Push-button spray selection			
• 360° swivel spout			
• 1.5 gpm (5.7 L/min) standard			



Modifications for Identity Kitchen Faucet

SUFFIX	DESCRIPTION	CHROME	STS
DP	8" deck plate for SK6710 Series	40.90	53.15

Oak™ Collection

Oak™



The Oak Collection seamlessly blends the classic allure of traditional design with the clean lines and trend-forward finishes that hint toward contemporary style.

Available in these finishes:

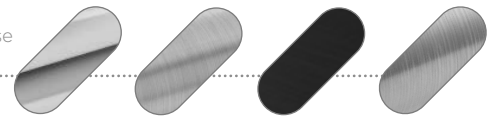

Polished
Chrome

Satin Nickel
Radiance® PVD
(STN)

Matte
Black
(MB)

Brushed Bronze
Radiance® PVD
(BBZ)

Faucets • Tub/Showers • Accessories





Oak™ Lavatory Faucets and Tub Filler

	DESCRIPTION	MODEL	FINISH	PRICE
	• Oak Widespread Lavatory Faucet	SLW5612PP	Chrome	657.35
	• 3-hole installation with 8-16" center	SLW5612STNPP	Satin Nickel	854.60
	• Threadless valve-to-spout connections	SLW5612MBPP	Matte Black	920.40
	• 3/8" braided hose connections	SLW5612BBZPP	Brushed Bronze	920.40
	• Ceramic cartridges			
	• Metal construction			
	• Metal push-pop drain assembly included			
	• 1.0 gpm (3.8 L/min) flow rate			
	WS P ♿ LF			

	• Oak Single Handle Lavatory Faucet	SLS5612PP	Chrome	432.40
	• Single-hole installation	SLS5612STNPP	Satin Nickel	562.05
	• 3/8" braided hose connections	SLS5612MBPP	Matte Black	605.35
	• Ceramic cartridges	SLS5612BBZPP	Brushed Bronze	605.35
	• Metal construction			
	• Metal push-pop drain assembly included			
	• 1.0 gpm (3.8 L/min) flow rate			
	WS P ♿ LF			

	• Oak Freestanding Tub Filler	<i>If tempering valve is required, use MaxLine® 7-230 Series (page 208)</i>		
	• Floor-mounted tub filler with single-handle temperature control	FSTF5672	Chrome	2269.10
		FSTF5672STN	Satin Nickel	2949.85
	• 4" HydroMersion hand shower wand with Total spray and push-button Pause mode	FSTF5672MB	Matte Black	3176.70
		FSTF5672BBZ	Brushed Bronze	3176.70
	• EverFlow rubber spray nozzles			
	• 60" flexible metal hose			
	• Metal lever handle			
	• 2.0 gpm (7.6 L/min) flow rate hand shower			
	• 5.3 gpm (20.1 L/min) at 45 psi tub filler			
	P			

Modifications for Oak Lavatory Faucets and Tub Filler					
SUFFIX	DESCRIPTION	CHROME	STN	BBZ	MB
05	CG 0.5 gpm (1.9 L/min) flow restrictor	N/A	N/A	N/A	N/A
L2	Less hand shower wand	-58.20	-75.70	-81.55	-81.55

DESCRIPTION	MODEL	FINISH	PRICE
 <ul style="list-style-type: none"> • Oak Shower Trim with VersaFlex Integral Diverter/Volume Control • 5" HydroMersion showerhead with Total spray • EverFlow rubber spray nozzles • VersaFlex Integral Diverter/Volume Control lever • Metal handle • 2.0 gpm (7.6 L/min) flow rate 	<i>Trim Only: S26 Series Temptrol® valve required (see page 151)</i>		
	S5691TRM	Chrome	455.55
	S5691STNTRM	Satin Nickel	592.25
	S5691MBTRM	Matte Black	637.75
	S5691BBZTRM	Brushed Bronze	637.75
	<i>Trim Only with flow control spindle and cap nut: S16 Series Temptrol® valve required (see page 151)</i>		
	S5691TRMTC	Chrome	533.05
	S5691STNTRMTC	Satin Nickel	669.75
	S5691MBTRMTC	Matte Black	715.25
	S5691BBZTRMTC	Brushed Bronze	715.25
WS P ♿			
 <ul style="list-style-type: none"> • Oak Shower Trim • 5" HydroMersion showerhead with Total spray • EverFlow rubber spray nozzles • Metal handle • 2.0 gpm (7.6 L/min) flow rate 	<i>Trim Only: 26 Series Temptrol® valve required (see page 139)</i>		
	5691TRM	Chrome	425.95
	5691STNTRM	Satin Nickel	553.70
	5691MBTRM	Matte Black	596.30
	5691BBZTRM	Brushed Bronze	596.30
	<i>Trim Only with flow control spindle and cap nut: 16 Series Temptrol® valve required (see page 139)</i>		
	5691TRMTC	Chrome	503.45
	5691STNTRMTC	Satin Nickel	631.20
	5691MBTRMTC	Matte Black	673.80
	5691BBZTRMTC	Brushed Bronze	673.80
WS P ♿			
 <ul style="list-style-type: none"> • Oak Tub and Shower Trim with VersaFlex Integral Diverter • 5" HydroMersion showerhead with Total spray • EverFlow rubber spray nozzles • VersaFlex Integral Diverter lever • 7-11/16" slip-on non-diverter tub spout • Metal handle • 2.0 gpm (7.6 L/min) flow rate 	<i>Trim Only: S26 Series Temptrol® valve required (see page 147)</i>		
	S5692TRM	Chrome	495.30
	S5692STNTRM	Satin Nickel	643.85
	S5692MBTRM	Matte Black	693.35
	S5692BBZTRM	Brushed Bronze	693.35
	<i>Trim Only with flow control spindle and cap nut: S16 Series Temptrol® valve required (see page 147)</i>		
	S5692TRMTC	Chrome	572.80
	S5692STNTRMTC	Satin Nickel	721.35
	S5692MBTRMTC	Matte Black	770.85
	S5692BBZTRMTC	Brushed Bronze	770.85
WS P ♿			
 <ul style="list-style-type: none"> • Oak Tub and Shower Trim • 5" HydroMersion showerhead with Total spray • EverFlow rubber spray nozzles • 7-11/16" slip-on diverter tub spout • Metal handle • 2.0 gpm (7.6 L/min) flow rate 	<i>Trim Only: 26 Series Temptrol® valve required (see page 139)</i>		
	5692TRM	Chrome	488.25
	5692STNTRM	Satin Nickel	634.75
	5692MBTRM	Matte Black	683.60
	5692BBZTRM	Brushed Bronze	683.60
	<i>Trim Only with flow control spindle and cap nut: 16 Series Temptrol® valve required (see page 139)</i>		
	5692TRMTC	Chrome	565.75
	5692STNTRMTC	Satin Nickel	712.25
	5692MBTRMTC	Matte Black	761.10
	5692BBZTRMTC	Brushed Bronze	761.10
WS P ♿			

Oak™ Shower and Tub/Shower



DESCRIPTION	MODEL	FINISH	PRICE
<ul style="list-style-type: none"> • Oak Hand Shower Trim 	<i>Trim Only: 26 Series Temptrol® valve required (see page 139)</i>		
<ul style="list-style-type: none"> • 4" single-function HydroMersion hand shower wand 	5693TRM	Chrome	804.20
	5693STNTRM	Satin Nickel	1045.45
<ul style="list-style-type: none"> • Hand shower wand features a Total spray and push-button Pause mode 	5693MBTRM	Matte Black	1125.85
	5693BBZTRM	Brushed Bronze	1125.85
<ul style="list-style-type: none"> • EverFlow rubber spray nozzles 	<i>Trim Only with flow control spindle and cap nut: 16 Series Temptrol® valve required (see page 139)</i>		
<ul style="list-style-type: none"> • 30" hand shower slide bar 	5693TRMTC	Chrome	881.70
<ul style="list-style-type: none"> • 60" flexible metal hose 	5693STNTRMTC	Satin Nickel	1122.95
<ul style="list-style-type: none"> • Metal lever handle 	5693MBTRMTC	Matte Black	1203.35
<ul style="list-style-type: none"> • 2.0 gpm (7.6 L/min) flow rate 	5693BBZTRMTC	Brushed Bronze	1203.35



<ul style="list-style-type: none"> • Oak Tub and Hand Shower Trim with VersaFlex Integral Diverter 	<i>Trim Only: S26 Series Temptrol® valve required (see page 147)</i>		
	S5694TRM	Chrome	844.20
<ul style="list-style-type: none"> • 4" HydroMersion hand shower wand with Total spray and push-button Pause mode 	S5694STNTRM	Satin Nickel	1097.45
	S5694MBTRM	Matte Black	1181.85
<ul style="list-style-type: none"> • EverFlow rubber spray nozzles 	S5694BBZTRM	Brushed Bronze	1181.85
<ul style="list-style-type: none"> • VersaFlex Integral Diverter lever 	<i>Trim Only with flow control spindle and cap nut: S16 Series Temptrol® valve required (see page 147)</i>		
<ul style="list-style-type: none"> • 7-11/16" slip-on non-diverter tub spout 	S5694TRMTC	Chrome	921.70
<ul style="list-style-type: none"> • 30" hand shower slide bar 	S5694STNTRMTC	Satin Nickel	1174.95
<ul style="list-style-type: none"> • 60" flexible metal hose 	S5694MBTRMTC	Matte Black	1259.35
<ul style="list-style-type: none"> • Metal handle 	S5694BBZTRMTC	Brushed Bronze	1259.35
<ul style="list-style-type: none"> • 2.0 gpm (7.6 L/min) flow rate 			



<ul style="list-style-type: none"> • Oak Shower and Hand Shower Trim with VersaFlex Integral Diverter 	<i>Trim Only: S26 Series Temptrol® valve required (see page 147)</i>		
	S5698TRM	Chrome	913.35
<ul style="list-style-type: none"> • 5" HydroMersion showerhead with Total spray 	S5698STNTRM	Satin Nickel	1187.35
	S5698MBTRM	Matte Black	1278.70
<ul style="list-style-type: none"> • 4" HydroMersion hand shower wand with Total spray and push-button Pause mode 	S5698BBZTRM	Brushed Bronze	1278.70
<ul style="list-style-type: none"> • EverFlow rubber spray nozzles 	<i>Trim Only with flow control spindle and cap nut: S16 Series Temptrol® valve required (see page 147)</i>		
<ul style="list-style-type: none"> • VersaFlex Integral Diverter lever 	S5698TRMTC	Chrome	990.85
<ul style="list-style-type: none"> • 30" hand shower slide bar 	S5698STNTRMTC	Satin Nickel	1264.85
<ul style="list-style-type: none"> • 60" flexible metal hose 	S5698MBTRMTC	Matte Black	1356.20
<ul style="list-style-type: none"> • Metal handle 	S5698BBZTRMTC	Brushed Bronze	1356.20
<ul style="list-style-type: none"> • 2.0 gpm (7.6 L/min) flow rate 			



Oak™ Shower and Tub/Shower

Oak™



DESCRIPTION	MODEL	FINISH	PRICE
<i>Trim Only: 26 Series Temptrol® and 2DIV Series valves required (see pages 139 and 158)</i>			
• Oak Shower and Hand Shower Trim	5695TRM	Chrome	1243.80
• 5" HydroMersion showerhead with Total spray	5695STNTRM	Satin Nickel	1616.95
• 4" HydroMersion hand shower wand with Total spray and push-button Pause mode	5695MBTRM	Matte Black	1741.30
	5695BBZTRM	Brushed Bronze	1741.30
<i>Trim Only with flow control spindle and cap nut: 16 Series Temptrol® and 2DIV Series valves required (see pages 139 and 158)</i>			
• EverFlow rubber spray nozzles	5695TRMTC	Chrome	1321.30
• Separate dual outlet diverter trim	5695STNTRMTC	Satin Nickel	1694.45
• 30" hand shower slide bar	5695MBTRMTC	Matte Black	1818.80
• 60" flexible metal hose	5695BBZTRMTC	Brushed Bronze	1818.80
• Metal handle			
• 2.0 gpm (7.6 L/min) flow rate			
• Brushed Bronze finish is Special Order			



<i>Trim Only: 26 Series Temptrol® and 3DIV Series valves required (see pages 139 and 158)</i>			
• Oak Shower System Trim	5696TRM	Chrome	1308.40
• 5" HydroMersion showerhead with Total spray	5696STNTRM	Satin Nickel	1700.90
• 4" HydroMersion hand shower wand with Total spray and push-button Pause mode	5696MBTRM	Matte Black	1831.70
	5696BBZTRM	Brushed Bronze	1831.70
<i>Trim Only with flow control spindle and cap nut: 16 Series Temptrol® and 3DIV Series valves required (see pages 139 and 158)</i>			
• EverFlow rubber spray nozzles	5696TRMTC	Chrome	1385.90
• Separate triple outlet diverter trim	5696STNTRMTC	Satin Nickel	1778.40
• 30" hand shower slide bar	5696MBTRMTC	Matte Black	1909.20
• 60" flexible metal hose	5696BBZTRMTC	Brushed Bronze	1909.20
• 7-11/16" slip-on non-diverter tub spout			
• Metal handle			
• 2.0 gpm (7.6 L/min) flow rate			
• Brushed Bronze finish is Special Order			



<i>Trim Only: S26 Series Temptrol® valve required (see pages 147 and 151)</i>			
• Oak Shower Valve Trim with VersaFlex Integral Diverter/Volume Control	S5690TRM	Chrome	336.65
• VersaFlex Integral Diverter/Volume Control lever	S5690STNTRM	Satin Nickel	437.60
	S5690MBTRM	Matte Black	471.30
• Metal handle	S5690BBZTRM	Brushed Bronze	471.30
<i>Trim Only with flow control spindle and cap nut: S16 Series Temptrol® valve required (see pages 147 and 151)</i>			
	S5690TRMTC	Chrome	414.15
	S5690STNTRMTC	Satin Nickel	515.10
	S5690MBTRMTC	Matte Black	548.80
	S5690BBZTRMTC	Brushed Bronze	548.80



Oak™ Shower and Tub/Shower



- DESCRIPTION**
- Oak Shower Valve Trim
 - Metal handle



MODEL	FINISH	PRICE
<i>Trim Only: 26 Series Temptrol® valve required (see page 139)</i>		
5690TRM	Chrome	317.85
5690STNTRM	Satin Nickel	413.20
5690MBTRM	Matte Black	445.00
5690BBZTRM	Brushed Bronze	445.00
<i>Trim Only with flow control spindle and cap nut: 16 Series Temptrol® valve required (see page 139)</i>		
5690TRMTC	Chrome	395.35
5690STNTRMTC	Satin Nickel	490.70
5690MBTRMTC	Matte Black	522.50
5690BBZTRMTC	Brushed Bronze	522.50

Modifications for Oak Shower and Tub/Shower Systems

SUFFIX	DESCRIPTION	CHROME	STN	BBZ	MB
15	1.5 gpm (5.7 L/min) flow restrictor	N/A	N/A	N/A	N/A
L1	Less showerhead	-43.60	-56.80	-61.05	-61.05
L2	Less hand shower	-58.20	-75.70	-81.55	-81.55
L3	Less showerhead and hand shower	-101.85	-132.40	-142.60	-142.60
L4	Less showerhead, arm and flange	-81.20	-105.45	-113.65	-113.65
L5	Less hand shower system	-235.95	-306.70	-330.30	-330.30
L6	Less tub spout	-29.40	-41.30	-42.80	-42.80
L7	Less handle	-51.35	-66.60	-71.85	71.85

Oak™ Shower and Tub/Shower Accessories

Oak™



DESCRIPTION	MODEL	FINISH	PRICE
	<i>2.0 gpm (7.6 L/min) standard</i>		
• Single-Function Showerhead	562SH	Chrome	109.05
• Standard on the Oak collection	562SHSTN	Satin Nickel	141.75
• 5" square	562SHMB	Matte Black	152.65
• HydroMersion technology for increased force	562SHBBZ	Brushed Bronze	152.65
	<i>1.5 gpm (5.7 L/min) WaterSense®, CALGreen</i>		
• EverFlow rubber spray nozzles	562SH15	Chrome	109.05
• Total spray for complete coverage	562SHSTN15	Satin Nickel	141.75
• Solid brass ball joint	562SHMB15	Matte Black	152.65
• Transitional style	562SHBBZ15	Brushed Bronze	152.65



	<i>2.0 gpm (7.6 L/min) standard</i>		
• Single-Function Hand Shower Wand	562W	Chrome	145.50
• Standard on the Oak collection	562WSTN	Satin Nickel	189.20
• 4" square	562WMB	Matte Black	203.80
• HydroMersion technology for increased force	562WBBZ	Brushed Bronze	203.80
	<i>1.5 gpm (5.7 L/min) WaterSense®</i>		
• EverFlow rubber spray nozzles	562W15	Chrome	145.50
• Total spray for complete coverage	562WSTN15	Satin Nickel	189.20
• Push-button Pause mode for non-positive shutoff	562WMB15	Matte Black	203.80
• Transitional style	562WBBZ15	Brushed Bronze	203.80



• Single-Function Hand Shower System	HS601	Chrome	499.90
• Coordinates with the Oak collection	HS601STN	Satin Nickel	649.90
• 4" HydroMersion hand shower wand with Total spray and push-button Pause mode	HS601MB	Matte Black	699.90
	HS601BBZ	Brushed Bronze	699.90
• EverFlow rubber spray nozzles			
• Integrated wall cradle and elbow			
• 60" flexible metal hose			
• Transitional style			
• 2.0 gpm (7.6 L/min) flow rate			



• Single-Function Hand Shower Slide Bar System	HS621	Chrome	589.90
	HS621STN	Satin Nickel	766.80
• Standard on the Oak collection	HS621MB	Matte Black	825.80
• 4" HydroMersion hand shower wand with Total spray and push-button Pause mode	HS621BBZ	Brushed Bronze	825.80
• EverFlow rubber spray nozzles			
• 30" hand shower slide bar			
• 60" flexible metal hose			
• Transitional style			
• 2.0 gpm (7.6 L/min) flow rate			



Oak™ Shower and Tub/Shower Accessories







	DESCRIPTION	MODEL	FINISH	PRICE		
	<ul style="list-style-type: none"> • 24" or 36" Slide/Grab Bar • 2-1/2" x 4-1/2" HydroMersion hand shower wand with Total spray and push-button Pause mode • EverFlow rubber spray nozzles • 60" flexible metal hose • 1-1/2" diameter slide bar • ADA slide mechanism • Wall elbow included • Contemporary/Modern style • 2.0 gpm (7.6 L/min) flow rate 	<i>24" Length</i>				
		H36924	Chrome	586.05		
		H36924STN	Satin Nickel	770.25		
		H36924MB	Matte Black	820.55		
		<i>36" Length</i>				
		H36936	Chrome	598.05		
		H36936STN	Satin Nickel	787.05		
		H36936MB	Matte Black	837.20		
		<p>WS P </p>				
			• Shower arm and flange	562SA	Chrome	101.55
• Standard on the Oak collection	562SASTN		Satin Nickel	132.05		
• 8" length	562SAMB		Matte Black	142.25		
	562SABBZ		Brushed Bronze	142.25		
<p>P</p>						
	• Oak Tub Spout	562TS	Chrome	73.95		
	• 7-11/16" length	562TSSTN	Satin Nickel	96.00		
	• Metal construction	562TSMB	Matte Black	103.40		
	• Slip-on installation	562TSBBZ	Brushed Bronze	103.40		
<p>P</p>						
	• Oak Diverter Tub Spout	562DTS	Chrome	73.95		
	• 7-11/16" length	562DTSSTN	Satin Nickel	96.00		
	• Pull-up diverter	562DTSMB	Matte Black	103.40		
	• Metal construction	562DTSBBZ	Brushed Bronze	103.40		
<p>P </p>						
	• Oak Diverter Valve Trim	<i>Trim Only: 2DIV-BODY or 3DIV-BODY required (see page 158)</i>				
	• 5" square	56DIVTRM	Chrome	349.25		
	• Metal handle	56DIVSTNTRM	Satin Nickel	454.05		
	• Screwless escutcheon	56DIVMBTRM	Matte Black	489.00		
	• Dual or triple outlet	56DIVBBZTRM	Brushed Bronze	489.00		
<p>• Brushed Bronze finish is Special Order</p> <p>P </p>						

Modifications for Oak Shower and Tub/Shower Accessories

SUFFIX	DESCRIPTION	CHROME	STN	BBZ	MB
15	1.5 gpm (5.7 L/min) flow restrictor	N/A	N/A	N/A	N/A

Oak™ Bath Accessories

Oak™

	DESCRIPTION	MODEL	FINISH	PRICE
	<ul style="list-style-type: none"> • 18" or 24" Towel Bar • Coordinates with Oak collection • Durable mounting system • Metal construction 	<i>18" Length</i>		
		563TB18	Chrome	100.45
		563TB18STN	Satin Nickel	130.55
		563TB18MB	Matte Black	140.60
		563TB18BBZ	Brushed Bronze	140.60
		<i>24" Length</i>		
		563TB24	Chrome	110.20
		563TB24STN	Satin Nickel	143.15
		563TB24MB	Matte Black	154.15
		563TB24BBZ	Brushed Bronze	154.15
	<ul style="list-style-type: none"> • Robe Hook • Coordinates with the Oak collection • Durable mounting system • Metal construction 	563RH	Chrome	32.50
		563RHSTN	Satin Nickel	42.25
		563RHMB	Matte Black	45.50
		563RHBBZ	Brushed Bronze	45.50
		P		
	<ul style="list-style-type: none"> • Towel Ring • Coordinates with Oak collection • Durable mounting system • Metal construction 	563TR	Chrome	63.95
		563TRSTN	Satin Nickel	83.25
		563TRMB	Matte Black	89.55
		563TRBBZ	Brushed Bronze	89.55
		P		
	<ul style="list-style-type: none"> • Toilet Paper Holder • Coordinates with Oak collection • Durable mounting system • Metal construction 	563TP	Chrome	61.65
		563TPSTN	Satin Nickel	80.20
		563TPMB	Matte Black	86.35
		563TPBBZ	Brushed Bronze	86.35
		P		
	<ul style="list-style-type: none"> • Double Toilet Paper Holder • Coordinates with Oak collection • Durable mounting system • Metal construction 	563DTP	Chrome	137.90
		563DTPSTN	Satin Nickel	179.25
		563DTPMB	Matte Black	193.00
		563DTPBBZ	Brushed Bronze	193.00
		P		
	<ul style="list-style-type: none"> • 24" or 36" Grab Bar • Coordinates with Oak collection • Metal construction • Screwless flanges • ADA compliant • Brushed Bronze finish is Special Order 	<i>24" Length</i>		
		563GB24	Chrome	249.15
		563GB24STN	Satin Nickel	323.90
		563GB24MB	Matte Black	348.80
		563GB24BBZ	Brushed Bronze	348.80
		<i>36" Length</i>		
		563GB36	Chrome	261.55
		563GB36STN	Satin Nickel	340.00
		563GB36MB	Matte Black	366.15
		563GB36BBZ	Brushed Bronze	366.15
P 				

Origins[®] Collection

Origins[®]



The one that started it all. The Origins Collection is a versatile Symmons transitional design that's right at home in any bath space.



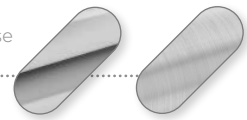

Available in these finishes:



Polished Chrome Satin Nickel Radiance[®] PVD (STN)

Faucets • Tub/Showers • Accessories

Origins® Lavatory Faucets

	DESCRIPTION	MODEL	FINISH	PRICE
	<ul style="list-style-type: none"> • Origins Single Handle Centerset Lavatory Faucet • 3-hole installation with 4" center • 3/8" braided hose connections • Ceramic cartridges • Metal construction • Metal push-pop drain assembly included • 1.0 gpm (3.8 L/min) flow rate 	<ul style="list-style-type: none"> S9612PP S9612STNPP 	<ul style="list-style-type: none"> Chrome Satin Nickel 	<ul style="list-style-type: none"> 124.30 174.05
	<p>WS LF</p>			
	<ul style="list-style-type: none"> • Origins Centerset Lavatory Faucet • 3-hole installation with 4" center • 3/8" braided hose connections • Ceramic cartridges • Metal construction • Metal push-pop drain assembly included • 1.0 gpm (3.8 L/min) flow rate 	<ul style="list-style-type: none"> SLC9612PP SLC9612STNPP 	<ul style="list-style-type: none"> Chrome Satin Nickel 	<ul style="list-style-type: none"> 139.25 195.00
	<p>WS LF</p>			
	<ul style="list-style-type: none"> • Origins Widespread Lavatory Faucet • 3-hole installation with 8-16" center • Threadless valve-to-spout connections • 3/8" braided hose connections • Ceramic cartridges • Metal push-pop drain assembly included • 1.0 gpm (3.8 L/min) flow rate 	<ul style="list-style-type: none"> S2442LAMPP S2442STNLAMPP 	<ul style="list-style-type: none"> Chrome Satin Nickel 	<ul style="list-style-type: none"> 491.45 692.00
	<p>WS LF</p>			
	<ul style="list-style-type: none"> • Origins Widespread Lavatory Faucet • 3-hole installation with 8-16" center • Threadless valve-to-spout connections • 3/8" braided hose connections • Ceramic cartridges • Metal push-pop drain assembly included • 1.0 gpm (3.8 L/min) flow rate 	<ul style="list-style-type: none"> S2442LWGPP S2442STNLWGPP 	<ul style="list-style-type: none"> Chrome Satin Nickel 	<ul style="list-style-type: none"> 491.45 692.00
	<p>WS LF</p>			
	<ul style="list-style-type: none"> • Origins Widespread Lavatory Faucet • 3-hole installation with 8-16" center • Threadless valve-to-spout connections • 3/8" braided hose connections • Ceramic cartridges • Drain assembly not included • 1.0 gpm (3.8 L/min) flow rate 	<ul style="list-style-type: none"> S2440LAM S2440STNLAM 	<ul style="list-style-type: none"> Chrome Chrome 	<ul style="list-style-type: none"> 454.05 543.35
	<p>WS LF</p>			

Origins® Lavatory Faucets













DESCRIPTION	MODEL	FINISH	PRICE
• Origins Widespread Lavatory Faucet	S2440LWG	Chrome	454.05
• 3-hole installation with 8-16" center	S2440STNLWG	Satin Nickel	543.35
• Threadless valve-to-spout connections			
• 3/8" braided hose connections			
• Ceramic cartridges			
• Drain assembly not included			
• 1.0 gpm (3.8 L/min) flow rate			





















Modifications for Origins Lavatory Faucets

SUFFIX	DESCRIPTION	CHROME	STN
05	0.5 gpm (1.9 L/min) flow restrictor	N/A	N/A

Origins® Shower and Tub/Shower

	DESCRIPTION	MODEL	FINISH	PRICE
	<ul style="list-style-type: none"> Origins Shower with VersaFlex Integral Volume Control Temptrol pressure-balancing valve Tri-star handle Adjustable stop screw to limit handle turn 2-3/4" single-mode showerhead Easy to clean rubber nozzles Red and blue indicators on escutcheon 2.0 gpm (7.6 L/min) flow rate Tub spout not included 	<i>Valve & Trim: S26 Series Temptrol® valve included (see page 151)</i>		
		S-9601-P	Chrome	363.70
		<i>Trim Only: S26 Series Temptrol® valve required (see page 151)</i>		
		S-9601-P-TRM	Chrome	190.40
		<i>Trim Only with flow control spindle and cap nut: S16 Series Temptrol® valve required (see page 151)</i>		
		S9601PTRMTC	Chrome	267.90
				
	<ul style="list-style-type: none"> Origins Shower with VersaFlex Integral Volume Control Temptrol pressure-balancing valve Metal lever handle Adjustable stop screw to limit handle turn 2-3/4" single-mode showerhead Easy to clean rubber nozzles Red and blue indicators on escutcheon 2.0 gpm (7.6 L/min) flow rate Tub spout not included 	<i>Valve & Trim: S26 Series Temptrol® valve included (see page 151)</i>		
		S-9601-PLR	Chrome	393.95
		S-9601-PLR-STN	Satin Nickel	458.55
		<i>Trim Only: S26 Series Temptrol® valve required (see page 151)</i>		
		S-9601-PLR-TRM	Chrome	221.10
		S-9601-PLR-TRM-STN	Satin Nickel	287.05
		<i>Trim Only with flow control spindle and cap nut: S16 Series Temptrol® valve required (see page 151)</i>		
		S9601PLRTRMTC	Chrome	298.60
		S9601PLRTRMSTNTC	Satin Nickel	364.55
	 			
	<ul style="list-style-type: none"> Origins Shower Temptrol pressure-balancing valve Tri-star handle Adjustable stop screw to limit handle turn 2-3/4" single-mode showerhead Easy to clean rubber nozzles Red and blue indicators on escutcheon 2.0 gpm (7.6 L/min) flow rate Tub spout not included 	<i>Valve & Trim: 26 Series Temptrol® valve included (see page 139)</i>		
		9601-P	Chrome	208.75
		<i>Trim Only: 26 Series Temptrol® valve required (see page 139)</i>		
		9601-P-TRM	Chrome	47.30
		<i>Trim Only with flow control spindle and cap nut: 16 Series Temptrol® valve required (see page 139)</i>		
		9601PTRMTC	Chrome	124.80
				
	<ul style="list-style-type: none"> Origins Shower Temptrol pressure-balancing valve Metal lever handle Adjustable stop screw to limit handle turn 2-3/4" single-mode showerhead Easy to clean rubber nozzles Red and blue indicators on escutcheon 2.0 gpm (7.6 L/min) flow rate Tub spout not included 	<i>Valve & Trim: 26 Series Temptrol® valve included (see page 139)</i>		
		9601-PLR	Chrome	240.00
		9601-PLR-STN	Satin Nickel	277.20
		<i>Trim Only: 26 Series Temptrol® valve required (see page 139)</i>		
		9601-PLR-TRM	Chrome	79.20
		9601-PLR-TRM-STN	Satin Nickel	117.05
		<i>Trim Only with flow control spindle and cap nut: 16 Series Temptrol® valve required (see page 139)</i>		
		9601PLRTRMTC	Chrome	156.70
		9601PLRTRMSTNTC	Satin Nickel	194.55
	 			

Origins[®] Shower and Tub/Shower

	DESCRIPTION	MODEL	FINISH	PRICE
  	<ul style="list-style-type: none"> Origins Tub and Shower with VersaFlex Integral Diverter Temptrol pressure-balancing valve Tri-star handle Adjustable stop screw to limit handle turn 5-1/4" non-diverter tub spout 2-3/4" single-mode showerhead Easy to clean rubber nozzles Red and blue indicators on escutcheon 2.0 gpm (7.6 L/min) flow rate 	<i>Valve & Trim: S26 Series Temptrol[®] valve included (see page 147)</i>		
		S-9602-P	Chrome	383.35
		<i>Trim Only: S26 Series Temptrol[®] valve required (see page 147)</i>		
		S-9602-P-TRM	Chrome	210.35
		<i>Trim Only with flow control spindle and cap nut: S16 Series Temptrol[®] valve required (see page 147)</i>		
		S9602PTRMTC	Chrome	287.85
				
  	<ul style="list-style-type: none"> Origins Tub and Shower with VersaFlex Integral Diverter Temptrol pressure-balancing valve Metal lever handle Adjustable stop screw to limit handle turn 5-1/4" non-diverter tub spout 2-3/4" single-mode showerhead Easy to clean rubber nozzles Red and blue indicators on escutcheon 2.0 gpm (7.6 L/min) flow rate 	<i>Valve & Trim: S26 Series Temptrol[®] valve included (see page 147)</i>		
		S-9602-PLR	Chrome	413.80
		S-9602-PLR-STN	Satin Nickel	486.30
		<i>Trim Only: S26 Series Temptrol[®] valve required (see page 147)</i>		
		S-9602-PLR-TRM	Chrome	241.35
	S-9602-PLR-TRM-STN	Satin Nickel	315.15	
	<i>Trim Only with flow control spindle and cap nut: S16 Series Temptrol[®] valve required (see page 147)</i>			
		S9602PLRTRMTC	Chrome	318.85
		S9602PLRTRMSTNTC	Satin Nickel	392.65
	 			
  	<ul style="list-style-type: none"> Origins Tub and Shower Temptrol pressure-balancing valve Tri-star handle Adjustable stop screw to limit handle turn 5-1/2" diverter tub spout 2-3/4" single-mode showerhead Easy to clean rubber nozzles Red and blue indicators on escutcheon 2.0 gpm (7.6 L/min) flow rate 	<i>Valve & Trim: 26 Series Temptrol[®] valve included (see page 139)</i>		
		9602-P	Chrome	217.60
		<i>Trim Only: 26 Series Temptrol[®] valve required (see page 139)</i>		
		9602-P-TRM	Chrome	56.40
		<i>Trim Only with flow control spindle and cap nut: 16 Series Temptrol[®] valve required (see page 139)</i>		
		9602PTRMTC	Chrome	133.90
				
  	<ul style="list-style-type: none"> Origins Tub and Shower Temptrol pressure-balancing valve Metal lever handle Adjustable stop screw to limit handle turn 5-1/2" diverter tub spout 2-3/4" single-mode showerhead Easy to clean rubber nozzles Red and blue indicators on escutcheon 2.0 gpm (7.6 L/min) flow rate 	<i>Valve & Trim: 26 Series Temptrol[®] valve included (see page 139)</i>		
		9602-PLR	Chrome	249.00
		9602-PLR-STN	Satin Nickel	285.15
		<i>Trim Only: 26 Series Temptrol[®] valve required (see page 139)</i>		
		9602-PLR-TRM	Chrome	88.25
	9602-PLR-TRM-STN	Satin Nickel	125.20	
	<i>Trim Only with flow control spindle and cap nut: 16 Series Temptrol[®] valve required (see page 139)</i>			
		9602PLRTRMTC	Chrome	165.75
		9602PLRTRMSTNTC	Satin Nickel	202.70
	 			

Origins® Shower and Tub/Shower

DESCRIPTION	MODEL	FINISH	PRICE
 <ul style="list-style-type: none"> • Origins Hand Shower with VersaFlex Integral Volume Control • Temptrol pressure-balancing valve • Metal lever handle • Adjustable stop screw to limit handle turn • ADA 36" grab bar for hand shower • 60" flexible metal hose • 3-3/8" ADA single-mode hand shower wand with non-positive shutoff • Red and blue indicators on escutcheon • 2.0 gpm (7.6 L/min) flow rate • Tub spout and showerhead not included 	<i>Valve & Trim: S26 Series Temptrol® valve included (see page 151)</i>		
	S-9603-PLR	Chrome	811.60
	S-9603-PLR-STN	Satin Nickel	1043.40
	<i>Trim Only: S26 Series Temptrol® valve required (see page 151)</i>		
	S-9603-PLR-TRM	Chrome	646.45
	S-9603-PLR-TRM-STN	Satin Nickel	882.60
	<i>Trim Only with flow control spindle and cap nut: S16 Series Temptrol® valve required (see page 151)</i>		
	S9603PLRTRMTC	Chrome	723.95
	S9603PLRTRMSTNTC	Satin Nickel	960.10



 <ul style="list-style-type: none"> • Origins Hand Shower • Temptrol pressure-balancing valve • Metal lever handle • Adjustable stop screw to limit handle turn • ADA 36" grab bar for hand shower • 60" flexible metal hose • 3-3/8" ADA single-mode hand shower wand with non-positive shutoff • Red and blue indicators on escutcheon • 2.0 gpm (7.6 L/min) flow rate • Tub spout and showerhead not included 	<i>Valve & Trim: 26 Series Temptrol® valve included (see page 139)</i>		
	9603-PLR	Chrome	611.15
	9603-PLR-STN	Satin Nickel	796.45
	<i>Trim Only: 26 Series Temptrol® valve required (see page 139)</i>		
	9603-PLR-TRM	Chrome	457.10
	9603-PLR-TRM-STN	Satin Nickel	645.75
	<i>Trim Only with flow control spindle and cap nut: 16 Series Temptrol® valve required (see page 139)</i>		
	9603PLRTRMTC	Chrome	534.60
	9603PLRTRMSTNTC	Satin Nickel	723.25



 <ul style="list-style-type: none"> • Origins Tub and Hand Shower with VersaFlex Integral Diverter • Temptrol pressure-balancing valve • Metal lever handle • Adjustable stop screw to limit handle turn • ADA 36" grab bar for hand shower • 5-1/4" non-diverter tub spout • 60" flexible metal hose • 3-3/8" ADA single-mode hand shower wand with non-positive shutoff • Red and blue indicators on escutcheon • 2.0 gpm (7.6 L/min) flow rate • Showerhead not included 	<i>Valve & Trim: S26 Series Temptrol® valve included (see page 147)</i>		
	S-9604-PLR	Chrome	836.40
	S-9604-PLR-STN	Satin Nickel	1078.30
	<i>Trim Only: S26 Series Temptrol® valve required (see page 147)</i>		
	S-9604-PLR-TRM	Chrome	671.85
	S-9604-PLR-TRM-STN	Satin Nickel	918.10
	<i>Trim Only with flow control spindle and cap nut: S16 Series Temptrol® valve required (see page 147)</i>		
	S9604PLRTRMTC	Chrome	749.35
	S9604PLRTRMSTNTC	Satin Nickel	995.60



Origins® Shower and Tub/Shower



DESCRIPTION	MODEL	FINISH	PRICE
<ul style="list-style-type: none"> • Origins Tub and Hand Shower • Temptrol pressure-balancing valve • Metal lever handle • Adjustable stop screw to limit handle turn • ADA 36" grab bar for hand shower • 5-1/2" diverter tub spout • 60" flexible metal hose • 3-3/8" ADA single-mode hand shower wand with non-positive shutoff • Red and blue indicators on escutcheon • 2.0 gpm (7.6 L/min) flow rate • Showerhead not included 	<i>Valve & Trim: 26 Series Temptrol® valve included (see page 139)</i>		
	9604-PLR	Chrome	647.40
	9604-PLR-STN	Satin Nickel	847.40
	<i>Trim Only: 26 Series Temptrol® valve required (see page 139)</i>		
	9604-PLR-TRM	Chrome	493.95
	9604-PLR-TRM-STN	Satin Nickel	697.60
	<i>Trim Only with flow control spindle and cap nut: 16 Series Temptrol® valve required (see page 139)</i>		
	9604PLRTRMTC	Chrome	571.45
	9604PLRTRMSTNTC	Satin Nickel	775.10





<ul style="list-style-type: none"> • Origins Shower and Hand Shower Trim with VersaFlex Integral Diverter • Metal lever handle • ADA 36" grab bar for hand shower • 60" flexible metal hose • 3-3/8" ADA single-mode hand shower wand with non-positive shutoff • 2-3/4" single-mode showerhead • Easy to clean rubber nozzles • Red and blue indicators on escutcheon • 2.0 gpm (7.6 L/min) flow rate • Tub spout not included 	<i>Trim Only: S26 Series Temptrol® valve required (see page 147)</i>		
	S9608PLRTRM	Chrome	594.90
	S9608PLRTRMSTN	Satin Nickel	809.60
	<i>Trim Only with flow control spindle and cap nut: S16 Series Temptrol® valve required (see page 147)</i>		
	S9608PLRTRMTC	Chrome	672.40
	S9608PLRTRMSTNTC	Satin Nickel	887.10



<ul style="list-style-type: none"> • Origins Shower and Hand Shower • Temptrol pressure-balancing valve • Metal lever handle • Adjustable stop screw to limit handle turn • ADA 36" grab bar for hand shower • Separate dual outlet diverter • 60" flexible metal hose • 3-3/8" ADA single-mode hand shower wand with non-positive shutoff • 2-3/4" single-mode showerhead • Easy to clean rubber nozzles • Red and blue indicators on escutcheon • 2.0 gpm (7.6 L/min) flow rate • Tub spout not included 	<i>Valve & Trim: 26 Series Temptrol® and 2DIV Series valves included (see pages 139 and 158)</i>		
	9605-PLR	Chrome	986.90
	9605-PLR-STN	Satin Nickel	1237.55
	<i>Trim Only: 26 Series Temptrol® and 2DIV Series valves required (see pages 139 and 158)</i>		
	9605-PLR-TRM	Chrome	629.05
	9605-PLR-TRM-STN	Satin Nickel	884.25
	<i>Trim Only with flow control spindle and cap nut: 16 Series Temptrol® and 2DIV Series valves required (see pages 139 and 158)</i>		
	9605PLRTRMTC	Chrome	706.55
	9605PLRTRMSTNTC	Satin Nickel	961.75



Origins® Shower and Tub/Shower

DESCRIPTION	MODEL	FINISH	PRICE	
 <ul style="list-style-type: none"> Origins Shower System with VersaFlex Dual Integral Diverter Temptrol pressure-balancing valve Metal lever handle Adjustable stop screw to limit handle turn Separate dual outlet diverter ADA 36" grab bar for hand shower VersaFlex Integral dual-outlet diverter lever 5-1/4" non-diverter tub spout 60" flexible metal hose 3-3/8" ADA single-mode hand shower wand with non-positive shutoff 2-3/4" single-mode showerhead Easy to clean rubber nozzles Red and blue indicators on escutcheon 2.0 gpm (7.6 L/min) flow rate 	<i>Valve & Trim: S26 Series Temptrol® and 2DIV Series valves included (see pages 147 and 158)</i>			
	S-9606-PLR	Chrome	1188.85	
	S-9606-PLR-STN	Satin Nickel	1506.35	
	<i>Trim Only: S26 Series Temptrol® and 2DIV Series valves required (see pages 147 and 158)</i>			
	S-9606-PLR-TRM	Chrome	819.90	
	S-9606-PLR-TRM-STN	Satin Nickel	1143.20	
	<i>Trim Only with flow control spindle and cap nut: S16 Series Temptrol® and 2DIV Series valves required (see pages 147 and 158)</i>			
	S9606PLRTRMTC	Chrome	897.40	
	S9606PLRTRMSTNTC	Satin Nickel	1220.70	
	<i>Valve & Trim: 26 Series Temptrol® and 3DIV Series valves included (see pages 139 and 158)</i>			
	 <ul style="list-style-type: none"> Origins Shower System Temptrol pressure-balancing valve Metal lever handle Adjustable stop screw to limit handle turn ADA 36" grab bar for hand shower Separate triple outlet diverter 5-1/2" non-diverter tub spout 60" flexible metal hose 3-3/8" ADA single-mode hand shower wand with non-positive shutoff 2-3/4" single-mode showerhead Easy to clean rubber nozzles Red and blue indicators on escutcheon 2.0 gpm (7.6 L/min) flow rate 	9606-PLR	Chrome	1061.65
		9606-PLR-STN	Satin Nickel	1320.90
		<i>Trim Only: 26 Series Temptrol® and 3DIV Series valves required (see pages 139 and 158)</i>		
		9606-PLR-TRM	Chrome	652.45
9606-PLR-TRM-STN		Satin Nickel	916.25	
<i>Trim Only with flow control spindle and cap nut: 16 Series Temptrol® and 3DIV Series valves required (see pages 139 and 158)</i>				
9606PLRTRMTC		Chrome	729.95	
9606PLRTRMSTNTC		Satin Nickel	993.75	
<i>Valve & Trim: S26 Series Temptrol® valve included (see page 151)</i>				
 <ul style="list-style-type: none"> Origins Shower Valve and Trim with VersaFlex Integral Volume Control Temptrol pressure-balancing valve Tri-star handle Adjustable stop screw to limit handle turn Red and blue indicators on escutcheon Tub spout and showerhead not included 		S-9600-P	Chrome	335.10
	<i>Trim Only: S26 Series Temptrol® valve required (see page 151)</i>			
	S-9600-P-TRM	Chrome	161.35	
	<i>Trim Only with flow control spindle and cap nut: S16 Series Temptrol® valve required (see page 151)</i>			
	S9600PTRMTC	Chrome	238.85	

Origins® Shower and Tub/Shower



- DESCRIPTION**
- Origins Shower Valve and Trim with VersaFlex Integral Volume Control
 - Temptrol pressure-balancing valve
 - Metal lever handle
 - Adjustable stop screw to limit handle turn
 - Red and blue indicators on escutcheon
 - Tub spout and showerhead not included



MODEL	FINISH	PRICE
<i>Valve & Trim: S26 Series Temptrol® valve included (see page 151)</i>		
S-9600-PLR	Chrome	357.65
S-9600-PLR-STN	Satin Nickel	407.75
<i>Trim Only: S26 Series Temptrol® valve required (see page 151)</i>		
S-9600-PLR-TRM	Chrome	184.25
S-9600-PLR-TRM-STN	Satin Nickel	235.25
<i>Trim Only with flow control spindle and cap nut: S16 Series Temptrol® valve required (see page 151)</i>		
S9600PLRTRMTC	Chrome	261.75
S9600PLRTRMSTNTC	Satin Nickel	312.75



- Origins Tub and Shower Valve and Trim with VersaFlex Integral Diverter
- Temptrol pressure-balancing valve
- Tri-star handle
- Adjustable stop screw to limit handle turn
- Red and blue indicators on escutcheon
- Tub and shower icons on escutcheon
- Tub spout and showerhead not included



<i>Valve & Trim: S26 Series Temptrol® valve included (see page 147)</i>		
S-9600TS-P	Chrome	335.10
<i>Trim Only: S26 Series Temptrol® valve required (see page 147)</i>		
S-9600TS-P-TRM	Chrome	161.35
<i>Trim Only with flow control spindle and cap nut: S16 Series Temptrol® valve required (see page 147)</i>		
S9600TSPTRMTC	Chrome	238.85



- Origins Tub and Shower Valve and Trim with VersaFlex Integral Diverter
- Temptrol pressure-balancing valve
- Metal lever handle
- Adjustable stop screw to limit handle turn
- Red and blue indicators on escutcheon
- Tub and shower icons on escutcheon
- Tub spout and showerhead not included



<i>Valve & Trim: S26 Series Temptrol® valve included (see page 147)</i>		
S-9600TS-PLR	Chrome	357.65
S-9600TS-PLR-STN	Satin Nickel	407.75
<i>Trim Only: S26 Series Temptrol® valve required (see page 147)</i>		
S-9600TS-PLR-TRM	Chrome	184.25
S-9600TS-PLR-TRM-STN	Satin Nickel	235.25
<i>Trim Only with flow control spindle and cap nut: S16 Series Temptrol® valve required (see page 147)</i>		
S9600TSPLRTRMTC	Chrome	261.75
S9600TSPLRTRMSTNTC	Satin Nickel	312.75







- Origins Valve and Trim
- Temptrol pressure-balancing valve
- Tri-star handle
- Adjustable stop screw to limit handle turn
- Red and blue indicators on escutcheon
- Plug included to make shower only
- Diverter tub spout and showerhead not included





<i>Valve & Trim: 26 Series Temptrol® valve included (see page 139)</i>		
9600-P	Chrome	185.40
<i>Trim Only: 26 Series Temptrol® valve required (see page 139)</i>		
9600-P-TRM	Chrome	23.55
<i>Trim Only with flow control spindle and cap nut: 16 Series Temptrol® valve required (see page 139)</i>		
9600PTRMTC	Chrome	101.05







Origins® Shower and Tub/Shower

	DESCRIPTION	MODEL	FINISH	PRICE
 <ul style="list-style-type: none"> • Origins Valve and Trim • Temptrol pressure-balancing valve • Metal lever handle • Adjustable stop screw to limit handle turn • Red and blue indicators on escutcheon • Plug included to make shower only • Diverter tub spout and showerhead not included 		<i>Valve & Trim: 26 Series Temptrol® valve included (see page 139)</i>		
		9600-PLR	Chrome	216.80
		9600-PLR-STN	Satin Nickel	242.75
		<i>Trim Only: 26 Series Temptrol® valve required (see page 139)</i>		
		9600-PLR-TRM	Chrome	55.50
		9600-PLR-TRM-STN	Satin Nickel	82.05
		<i>Trim Only with flow control spindle and cap nut: 16 Series Temptrol® valve required (see page 139)</i>		
		9600PLRTRMTC	Chrome	133.00
		9600PLRTRMSTNTC	Satin Nickel	159.55
 <ul style="list-style-type: none"> • Origins Shower Valve 13" Trim with VersaFlex Integral Volume Control • Metal lever handle • Red and blue indicators on escutcheon • Tub spout and showerhead not included 		<i>Trim Only: S26 Series Temptrol® valve required (see page 151)</i>		
		S-9600-PLR-OP-TRM	Chrome	275.50
		S-9600-PLR-OP-TRM-STN	Satin Nickel	355.05
		<i>Trim Only with flow control spindle and cap nut: S16 Series Temptrol® valve required (see page 151)</i>		
		S9600PLROPTRMTC	Chrome	353.00
		S9600PLROPTRMSTNTC	Satin Nickel	432.55
 <ul style="list-style-type: none"> • Origins Tub and Shower 13" Trim with VersaFlex Integral Diverter • Metal lever handle • Tub and shower icons on escutcheon • Red and blue indicators on escutcheon • Tub spout and showerhead not included 		<i>Trim Only: S26 Series Temptrol® valve required (see page 151)</i>		
		S-9600TS-PLR-OP-TRM	Chrome	275.50
		S-9600TS-PLR-OP-TRM-STN	Satin Nickel	355.05
		<i>Trim Only with flow control spindle and cap nut: S16 Series Temptrol® valve required (see page 151)</i>		
		S9600TSPLROPTRMTC	Chrome	353.00
		S9600TSPLROPTRMSTNTC	Satin Nickel	432.55
 <ul style="list-style-type: none"> • Origins 13" Trim • Metal lever handle • Red and blue indicators on escutcheon • Diverter tub spout and showerhead not included 		<i>Trim Only: 26 Series Temptrol® valve required (see page 139)</i>		
		9600-PLR-OP-TRM	Chrome	146.80
		9600-PLR-OP-TRM-STN	Satin Nickel	201.80
		<i>Trim Only with flow control spindle and cap nut: 16 Series Temptrol® valve required (see page 139)</i>		
		9600PLROPTRMTC	Chrome	224.30
		9600PLROPTRMSTNTC	Satin Nickel	279.30











Modifications for Origins Shower and Tub/Shower Systems

SUFFIX	DESCRIPTION	CHROME	STN
15	 1.5 gpm (5.7 L/min) flow restrictor	N/A	N/A
B	Brass escutcheon & dome (chrome only)	59.65	N/A
CHKS	Integral check stops - for use in installations where a positive shut-off device is used downstream of mixing valve	121.70	121.70
L1	Less showerhead (available on "trim only" SKUs)	-29.05	-46.50
L2	Less hand shower (available on "trim only" SKUs)	-48.45	-69.70
L3	Less showerhead and hand shower (available on "trim only" SKUs)	-77.50	-116.25
L4	Less showerhead, arm and flange (available on "trim only" SKUs)	-43.30	-64.80
L5	Less hand shower system (available on "trim only" SKUs)	-219.80	-285.45
L6	Less tub spout (for non diverter tub spout, deduct this line) (available on "trim only" SKUs)	-15.00	-23.90
L6.	Less tub spout (for diverter tub spout, deduct this line) (available on "trim only" SKUs)	-33.60	-47.20
L7	Less handle (PLR handle only) (available on "trim only" SKUs)	-40.70	-57.05
NS	 Non-shared diverter valve for 9605, 9606 and S-9606 series	N/C	N/C
X	Integral service stops - allows water shutoff at valve for service	31.50	31.50

Origins® Shower and Tub/Shower Accessories

	DESCRIPTION	MODEL	FINISH	PRICE
	<ul style="list-style-type: none"> • Single-Function Showerhead • Female ball joint connection • 2-3/4" diameter • Easy to clean rubber nozzles • 2.0 gpm (7.6 L/min) flow rate 	<i>2.0 gpm (7.6 L/min) standard</i>		
		4-141	Chrome	63.25
		4-141-STN	Satin Nickel	106.50
		<i>1.5 gpm (5.7 L/min) WaterSense®, CALGreen</i>		
		4-141-1.5	Chrome	63.25
		4-141-STN-1.5	Satin Nickel	101.20
		<i>2.0 gpm (7.6 L/min) standard</i>		
<ul style="list-style-type: none"> • ADA Hand Shower Wand • 3-3/8" diameter • Non-positive shutoff button • 2.0 gpm (7.6 L/min) flow rate 	ADACHS	Chrome	108.60	
	ADACHS-STN	Satin Nickel	152.05	
	ADACHS-MB	Matte Black	157.60	
	ADACHS-BBZ	Brushed Bronze	157.60	
	ADACHS-WHT	White	79.00	
	<i>1.5 gpm (5.7 L/min) WaterSense®</i>			
	ADACHS-1.5	Chrome	108.60	
	ADACHS-1.5-STN	Satin Nickel	152.05	
	ADACHS-MB-1.5	Matte Black	157.60	
	ADACHS-BBZ-1.5	Brushed Bronze	157.60	
ADACHS-1.5-WHT	White	79.00		
	• Multifunction Hand Shower Slide Bar System	HR527	Chrome	557.20
	• Coordinates with the Dia collection	HR527STN	Satin Nickel	724.35
<ul style="list-style-type: none"> • 4" HydroMersion hand shower wand with 7 modes • EverFlow rubber spray nozzles • 30" hand shower slide bar • 60" flexible metal hose • Contemporary/Modern style • 2.0 gpm (7.6 L/min) flow rate 	P 			
	• 1-1/2" Diameter Grab Bar/Slide Bar	T724	24" Chrome	518.15
	• ADA slide mechanism	T724-STN	24" Satin Nickel	637.65
	• 60" flexible metal hose	T736	36" Chrome	549.05
	• ADA Chrome or Satin Nickel hand shower wand with non-positive shutoff	T736-STN	36" Satin Nickel	674.80
	• Supply elbow included	T748	48" Chrome	606.10
	• Wall connection and flange	T748-STN	48" Satin Nickel	737.20
	• 2.0 gpm (7.6 L/min) flow rate			
				
				

Origins® Shower and Tub/Shower Accessories

	DESCRIPTION	MODEL	FINISH	PRICE
	• 1-1/2" Diameter Grab Bar/Slide Bar	T24-WT	24" White	491.90
	• ADA slide mechanism	T36-WT	36" White	522.85
	• 60" flexible metal hose	T48-WT	48" White	574.90
	• ADA white hand shower wand with non-positive shutoff • Supply elbow included • Wall connection and flange • 2.0 gpm (7.6 L/min) flow rate			
				
	• Short shower arm and flange	300S	Chrome	26.85
	• Stamped flange • 6" length	300S-STN	Satin Nickel	40.30
				
	• Shower arm with heavy flange	300	Chrome	83.00
	• 8" length	300-STN	Satin Nickel	107.50
				
	• Non-diverter tub spout	060	Chrome	32.70
	• 5-1/4" length • Metal construction • Thread-on installation	060-STN	Satin Nickel	49.60
				
	• Diverter tub spout	054	Chrome	73.50
	• 5-1/2" length • Pull-up diverter • Metal construction • Thread-on installation	054-STN	Satin Nickel	106.15
				
	• Non-diverter tub spout	061	Chrome	57.40
	• 5-1/4" length • Metal construction • Slip-on installation	061-STN	Satin Nickel	93.95

Origins® Shower and Tub/Shower Accessories



DESCRIPTION	MODEL	FINISH	PRICE
• Diverter tub spout	053	Chrome	87.75
• 5-1/2" length	053-STN	Satin Nickel	142.25
• 1/2" inlet			
• Pull-up diverter			
• Metal construction			
• Slip-on installation			



- Origins Diverter Trim
- 4-1/4" diameter
- Screwed escutcheon
- Dual or triple outlet



Valve & Trim: 2DIV-BODY included (see page 158)

96-2DIV-PLR	Chrome	366.80
96-2DIV-PLR-STN	Satin Nickel	430.80

















Trim Only: 2DIV-BODY required (see page 158)

96-DIV-PLR-TRM	Chrome	162.65
96-DIV-PLR-TRM-STN	Satin Nickel	227.95





Modifications for Origins Shower and Tub/Shower Accessories

SUFFIX	DESCRIPTION	CHROME	STN
15	1.5 gpm (5.7 L/min) flow restrictor	N/A	N/A



Origins® Kitchen Faucets

	DESCRIPTION	MODEL	FINISH	PRICE
	<ul style="list-style-type: none"> • Origins Single Handle Kitchen Faucet • 8-5/8" swivel spout • Separate hand spray mounted within deck plate • Braided hose connections • 8" deck plate included • 1.5 gpm (5.7 L/min) flow rate 	SK233	Chrome	377.65
	  			
	<ul style="list-style-type: none"> • Origins Single Handle Kitchen Faucet • 8-5/8" swivel spout • Separate hand spray • Braided hose connections • 8" deck plate included • 1.5 gpm (5.7 L/min) flow rate 	SK232	Chrome	328.25
	  		Satin Nickel	450.75
	<ul style="list-style-type: none"> • Origins Single Handle Kitchen Faucet • 8-5/8" swivel spout • Ceramic cartridge • Braided hose supply lines • 360° swivel spout head • 8" deck plate included • 1.5 gpm (5.7 L/min) flow rate 	SK231	Chrome	323.05
	  			
	<ul style="list-style-type: none"> • Origins Single Handle Kitchen Faucet • 8-5/8" swivel spout • Braided hose connections • 8" deck plate included • 1.5 gpm (5.7 L/min) flow rate 	SK23	Chrome	269.05
	  		Satin Nickel	342.05
	<ul style="list-style-type: none"> • Origins Kitchen Faucet • 8-5/8" swivel spout • Braided hose connections • 8" deck plate included • 1.5 gpm (5.7 L/min) flow rate 	SK248	Chrome	283.75
	 			

Origins® Kitchen Faucets

	DESCRIPTION	MODEL	FINISH	PRICE
	<ul style="list-style-type: none"> • Origins Kitchen Faucet • 8-5/8" swivel spout • Braided hose connections • 8" deck plate included • 1.5 gpm (5.7 L/min) flow rate 	SK248LAM	Chrome	311.05
				
	<ul style="list-style-type: none"> • Origins Kitchen Faucet • 8-5/8" swivel spout • Braided hose connections • 8" deck plate included • 1.5 gpm (5.7 L/min) flow rate 	SK248LWG	Chrome	311.05
				

Modifications for Origins Kitchen Faucets

SUFFIX	DESCRIPTION	CHROME	STN
05	 0.5 gpm (1.9 L/min) flow restrictor (SK23 series, except SK231) (Call for availability)	N/A	N/A
10.	 1.0 gpm (3.8 L/min) flow restrictor (SK23 series, except SK231) (Call for availability)	N/A	N/A
W	6" lever handle (SK23 series only) (Chrome only)	21.50	N/A

Solarity™ Collection



Solarity™



The Solarity Collection shines in today's contemporary bath spaces, with on-trend finishes and smooth, rounded elements for a clean and inviting look.

Available in these finishes:

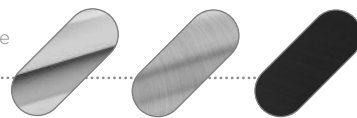

Polished
Chrome

Satin Nickel
Radiance® PVD
(STN)

Matte
Black
(MB)

Faucets • Tub/Showers • Accessories

Solarity™ Lavatory Faucets



DESCRIPTION	MODEL	FINISH	PRICE
• Solarity Widespread Lavatory Faucet	SLW3312PP	Chrome	415.80
• 3-hole installation with 8-16" center	SLW3312STNPP	Satin Nickel	540.50
• Threadless valve-to-spout connections	SLW3312MBPP	Matte Black	582.10
• 3/8" braided hose connections			
• Ceramic cartridges			
• Metal push-pop drain assembly included			
• 1.0 gpm (3.8 L/min) flow rate			



• Solarity Single Handle Lavatory Faucet	SLS3312PP	Chrome	330.40
• Single-hole installation	SLS3312STNPP	Satin Nickel	429.45
• 3/8" braided hose connections	SLS3312MBPP	Matte Black	462.55
• Ceramic cartridges			
• Metal construction			
• Metal push-pop drain assembly included			
• 1.0 gpm (3.8 L/min) flow rate			



Modifications for Solarity Lavatory Faucets

SUFFIX	DESCRIPTION	CHROME	STN	MB
05	0.5 gpm (1.9 L/min) flow restrictor	N/A	N/A	N/A

Solarity™ Shower and Tub/Shower

DESCRIPTION	MODEL	FINISH	PRICE
 <ul style="list-style-type: none"> Solarity Shower Trim with VersaFlex Integral Diverter/Volume Control 4" HydroMersion showerhead with Total spray EverFlow rubber spray nozzles VersaFlex Integral Diverter/Volume Control lever Metal handle 2.0 gpm (7.6 L/min) flow rate 	<i>Trim Only: S26 Series Temptrol® valve required (see page 151)</i>		
	S3391TRM	Chrome	293.30
	S3391STNTRM	Satin Nickel	381.30
	S3391MBTRM	Matte Black	410.65
	<i>Trim Only with flow control spindle and cap nut: S16 Series Temptrol® valve required (see page 151)</i>		
	S3391TRMTC	Chrome	370.80
S3391STNTRMTC	Satin Nickel	458.80	
S3391MBTRMTC	Matte Black	488.15	



 <ul style="list-style-type: none"> Solarity Shower Trim 4" HydroMersion showerhead with Total spray EverFlow rubber spray nozzles Metal handle 2.0 gpm (7.6 L/min) flow rate 	<i>Trim Only: 26 Series Temptrol® valve required (see page 139)</i>		
	3391TRM	Chrome	224.30
	3391STNTRM	Satin Nickel	291.50
	3391MBTRM	Matte Black	313.95
	<i>Trim Only with flow control spindle and cap nut: 16 Series Temptrol® valve required (see page 139)</i>		
	3391TRMTC	Chrome	301.80
3391STNTRMTC	Satin Nickel	369.00	
3391MBTRMTC	Matte Black	391.45	



 <ul style="list-style-type: none"> Solarity Tub and Shower Trim with VersaFlex Integral Diverter 4" HydroMersion showerhead with Total spray EverFlow rubber spray nozzles VersaFlex Integral Diverter lever 5-1/2" non-diverter tub spout Metal handle 2.0 gpm (7.6 L/min) flow rate 	<i>Trim Only: S26 Series Temptrol® valve required (see page 147)</i>		
	S3392TRM	Chrome	315.65
	S3392STNTRM	Satin Nickel	410.05
	S3392MBTRM	Matte Black	441.90
	<i>Trim Only with flow control spindle and cap nut: S16 Series Temptrol® valve required (see page 147)</i>		
	S3392TRMTC	Chrome	393.15
S3392STNTRMTC	Satin Nickel	487.55	
S3392MBTRMTC	Matte Black	519.40	



 <ul style="list-style-type: none"> Solarity Tub and Shower Trim 4" HydroMersion showerhead with Total spray EverFlow rubber spray nozzles 5-1/2" diverter tub spout Metal handle 2.0 gpm (7.6 L/min) flow rate 	<i>Trim Only: 26 Series Temptrol® valve required (see page 139)</i>		
	3392TRM	Chrome	238.25
	3392STNTRM	Satin Nickel	301.40
	3392MBTRM	Matte Black	333.55
	<i>Trim Only with flow control spindle and cap nut: 16 Series Temptrol® valve required (see page 139)</i>		
	3392TRMTC	Chrome	315.75
3392STNTRMTC	Satin Nickel	378.90	
3392MBTRMTC	Matte Black	411.05	



Solarity™ Shower and Tub/Shower



DESCRIPTION	MODEL	FINISH	PRICE
<ul style="list-style-type: none"> Solarity Hand Shower Trim 	<i>Trim Only: 26 Series Temptrol® valve required (see page 139)</i>		
<ul style="list-style-type: none"> 4" single-function HydroMersion hand shower wand with Total spray and Pause mode 	3393TRM	Chrome	555.10
	3393STNTRM	Satin Nickel	721.70
	3393MBTRM	Matte Black	777.15
<ul style="list-style-type: none"> EverFlow rubber spray nozzles 	<i>Trim Only with flow control spindle and cap nut: 16 Series Temptrol® valve required (see page 147)</i>		
<ul style="list-style-type: none"> 30" hand shower slide bar 	3393TRMTC	Chrome	632.60
<ul style="list-style-type: none"> 60" flexible metal hose 	3393STNTRMTC	Satin Nickel	799.20
<ul style="list-style-type: none"> Metal handle 	3393MBTRMTC	Matte Black	854.65
<ul style="list-style-type: none"> 2.0 gpm (7.6 L/min) flow rate 			



<ul style="list-style-type: none"> Solarity Tub and Hand Shower Trim with VersaFlex Integral Diverter 	<i>Trim Only: S26 Series Temptrol® valve required (see page 147)</i>		
<ul style="list-style-type: none"> 4" HydroMersion hand shower wand with Total spray and Pause mode 	S3394TRM	Chrome	633.55
	S3394STNTRM	Satin Nickel	823.60
	S3394MBTRM	Matte Black	886.95
<ul style="list-style-type: none"> EverFlow rubber spray nozzles 	<i>Trim Only with flow control spindle and cap nut: S16 Series Temptrol® valve required (see page 147)</i>		
<ul style="list-style-type: none"> VersaFlex Integral Diverter lever 	S3394TRMTC	Chrome	711.05
<ul style="list-style-type: none"> 5-1/2" non-diverter tub spout 	S3394STNTRMTC	Satin Nickel	901.10
<ul style="list-style-type: none"> 30" hand shower slide bar 	S3394MBTRMTC	Matte Black	964.45
<ul style="list-style-type: none"> 60" flexible metal hose 			
<ul style="list-style-type: none"> Metal handle 			
<ul style="list-style-type: none"> 2.0 gpm (7.6 L/min) flow rate 			



<ul style="list-style-type: none"> Solarity Shower and Hand Shower Trim with VersaFlex Integral Diverter 	<i>Trim Only: S26 Series Temptrol® valve required (see page 147)</i>		
<ul style="list-style-type: none"> 4" HydroMersion showerhead with Total spray 	S3398TRM	Chrome	595.55
	S3398STNTRM	Satin Nickel	774.15
	S3398MBTRM	Matte Black	833.80
<ul style="list-style-type: none"> 4" HydroMersion hand shower wand with Total spray and Pause mode 	<i>Trim Only with flow control spindle and cap nut: S16 Series Temptrol® valve required (see page 147)</i>		
<ul style="list-style-type: none"> EverFlow rubber spray nozzles 	S3398TRMTC	Chrome	673.05
<ul style="list-style-type: none"> VersaFlex Integral Diverter lever 	S3398STNTRMTC	Satin Nickel	851.65
<ul style="list-style-type: none"> 30" hand shower slide bar 	S3398MBTRMTC	Matte Black	911.30
<ul style="list-style-type: none"> 60" flexible metal hose 			
<ul style="list-style-type: none"> Metal handle 			
<ul style="list-style-type: none"> 2.0 gpm (7.6 L/min) flow rate 			



Solarity™ Shower and Tub/Shower



DESCRIPTION	MODEL	FINISH	PRICE
<i>Trim Only: 26 Series Temptrol® and 2DIV Series valves required (see pages 139 and 158)</i>			
• Solarity Shower and Hand Shower Trim	3395TRM	Chrome	765.75
• 4" HydroMersion showerhead with Total spray	3395STNTRM	Satin Nickel	995.45
• 4" HydroMersion hand shower wand with Total spray and Pause mode	3395MBTRM	Matte Black	1072.05
<i>Trim Only with flow control spindle and cap nut: 16 Series Temptrol® and 2DIV Series valves required (see pages 139 and 158)</i>			
• Separate dual outlet diverter trim	3395TRMTC	Chrome	843.25
• EverFlow rubber spray nozzles	3395STNTRMTC	Satin Nickel	1072.95
• 30" hand shower slide bar	3395MBTRMTC	Matte Black	1149.55
• 60" flexible metal hose			
• Metal handle			
• 2.0 gpm (7.6 L/min) flow rate			



<i>Trim Only: 26 Series Temptrol® and 3DIV Series valves required (see pages 139 and 158)</i>			
• Solarity Shower System Trim	3396TRM	Chrome	793.20
• 4" HydroMersion showerhead with Total spray	3396STNTRM	Satin Nickel	1031.20
• 4" HydroMersion hand shower wand with Total spray and Pause mode	3396MBTRM	Matte Black	1110.50
<i>Trim Only with flow control spindle and cap nut: 16 Series Temptrol® and 3DIV Series valves required (see pages 139 and 158)</i>			
• EverFlow rubber spray nozzles	3396TRMTC	Chrome	870.70
• Separate triple outlet diverter trim	3396STNTRMTC	Satin Nickel	1108.70
• 30" hand shower slide bar	3396MBTRMTC	Matte Black	1188.00
• 60" flexible metal hose			
• 5-1/2" non-diverter tub spout			
• Metal handle			
• 2.0 gpm (7.6 L/min) flow rate			



<i>Trim Only: S26 Series Temptrol® valve required (see pages 147 and 151)</i>			
• Solarity Shower Valve Trim with VersaFlex Integral Diverter/Volume Control	S3390TRM	Chrome	238.15
	S3390STNTRM	Satin Nickel	309.60
• VersaFlex Integral Diverter/Volume Control lever	S3390MBTRM	Matte Black	333.40
<i>Trim Only with flow control spindle and cap nut: S16 Series Temptrol® valve required (see pages 147 and 151)</i>			
• Metal handle	S3390TRMTC	Chrome	315.65
	S3390STNTRMTC	Satin Nickel	387.10
	S3390MBTRMTC	Matte Black	410.90



<i>Trim Only: 26 Series Temptrol® valve required (see page 139)</i>			
• Solarity Shower Valve Trim	3390TRM	Chrome	178.25
• Metal handle	3390STNTRM	Satin Nickel	231.70
	3390MBTRM	Matte Black	249.60
<i>Trim Only with flow control spindle and cap nut: 16 Series Temptrol® valve required (see page 139)</i>			
	3390TRMTC	Chrome	255.75
	3390STNTRMTC	Satin Nickel	309.20
	3390MBTRMTC	Matte Black	327.10



Modifications for Solarity Shower and Tub/Shower Systems

SUFFIX	DESCRIPTION	CHROME	STN	MB
15	 1.5 gpm (5.7 L/min) flow restrictor	N/A	N/A	N/A
L1	Less showerhead	-29.60	-38.50	-41.40
L2	Less hand shower	-34.30	-44.60	-48.00
L3	Less showerhead and hand shower	-64.70	-83.15	-89.50
L4	Less showerhead, arm and flange	-43.80	-56.95	-62.05
L5	Less hand shower system	-176.10	-228.90	-246.40
L6	Less tub spout (for non diverter tub spout, deduct this line)	-15.00	-18.95	-21.05
L6.	Less tub spout (for diverter tub spout, deduct this line)	-32.70	-42.45	-47.10
L7	Less handle	-25.75	-33.45	-36.10

Solarity™ Shower and Tub/Shower Accessories



DESCRIPTION	MODEL	FINISH	PRICE
	<i>2.0 gpm (7.6 L/min) standard</i>		
• Single-Function Showerhead	482SH	Chrome	74.05
• Standard on the Identity collection	482SHSTN	Satin Nickel	96.30
• 4" diameter	482SHMB	Matte Black	103.60
• HydroMersion technology for increased force	<i>1.5 gpm (5.7 L/min) WaterSense®, CALGreen</i>		
• Total spray for complete coverage	482SH15	Chrome	74.05
• EverFlow rubber spray nozzles	482SHSTN15	Satin Nickel	96.30
• Solid brass ball joint	482SHMB15	Matte Black	103.60
• Contemporary/Modern style			



	<i>2.0 gpm (7.6 L/min) standard</i>		
• Single-Function Hand Shower Wand	482W	Chrome	85.75
• Standard on the Identity collection	482WSTN	Satin Nickel	111.45
• 4" diameter	482WMB	Matte Black	120.05
• HydroMersion technology for increased force	<i>1.5 gpm (5.7 L/min) WaterSense®, CALGreen</i>		
• Total spray for complete coverage	482W	Chrome	85.75
• Pause mode for non-positive shutoff	482WSTN15	Satin Nickel	111.45
• EverFlow rubber spray nozzles	482WMB15	Matte Black	120.05
• Easy-shift thumb lever			
• Contemporary/Modern style			









• Single-Function Hand Shower System	HR501	Chrome	440.10
• Standard on the Identity collection	HR501STN	Satin Nickel	572.15
• 4" HydroMersion hand shower wand with Total spray Pause mode	HR501MB	Matte Black	616.15
• EverFlow rubber spray nozzles			
• Wall cradle and elbow			
• 60" flexible metal hose			
• Contemporary/Modern style			
• 2.0 gpm (7.6 L/min) flow rate			



• Single-Function Hand Shower Slide Bar System	HR521	Chrome	530.05
	HR521STN	Satin Nickel	689.10
• Coordinates with the Identity collection	HR521MB	Matte Black	742.05
• 4" HydroMersion hand shower wand with Total spray and Pause mode			
• EverFlow rubber spray nozzles			
• 30" hand shower slide bar			
• 60" flexible metal hose			
• Contemporary/Modern style			
• 2.0 gpm (7.6 L/min) flow rate			







Solarity™ Shower and Tub/Shower Accessories

	DESCRIPTION	MODEL	FINISH	PRICE
	• Short shower arm and flange	300S	Chrome	26.85
	• Stamped flange	300S-STN	Satin Nickel	40.30
	• 6" length	300S-MB	Matte Black	41.25
P				
	• Non-diverter tub spout	060	Chrome	32.70
	• 5-1/4" length	060-STN	Satin Nickel	49.60
	• Metal construction	060MB	Matte Black	52.55
P				
	• Diverter tub spout	054	Chrome	73.50
	• 5-1/2" length	054-STN	Satin Nickel	106.15
	• Pull-up diverter	054MB	Matte Black	114.35
P				
	• Non-diverter tub spout	061	Chrome	57.40
	• 5-1/4" length	061-STN	Satin Nickel	93.95
	• Metal construction			
P				
	• Diverter tub spout	053	Chrome	87.75
	• 5-1/2" length	053-STN	Satin Nickel	142.25
	• 1/2" inlet			
P				
	• Solarity Diverter Valve Trim	<i>Trim Only: 2DIV-BODY or 3DIV-BODY required (see page 158)</i>		
	• 5" diameter	33DIVTRM	Chrome	232.15
	• Metal lever handle	33DIVSTNTRM	Satin Nickel	301.80
	• Screwed escutcheon	33DIVMBTRM	Matte Black	325.05
P 				

Modifications for Solarity Shower and Tub/Shower Accessories

SUFFIX	DESCRIPTION	CHROME	STN	MB
15	 1.5 gpm (5.7 L/min) flow restrictor	N/A	N/A	N/A

Solarity™ Bath Accessories

	DESCRIPTION	MODEL	FINISH	PRICE	
	<ul style="list-style-type: none"> • 18" or 24" Towel Bar • Coordinates with Dia and Identity collections • Metal construction • Durable mounting system 	<i>18" Length</i>			
		353TB-18	Chrome	87.65	
		353TB-18-STN	Satin Nickel	113.70	
		353TB-18-MB	Matte Black	123.30	
		<i>24" Length</i>			
		353TB-24	Chrome	96.10	
		353TB-24-STN	Satin Nickel	125.00	
		353TB-24-MB	Matte Black	135.25	
		P			
	<ul style="list-style-type: none"> • Robe Hook • Coordinates with Dia and Identity collections • Durable mounting system • Metal construction 	353RH	Chrome	28.20	
		353RH-STN	Satin Nickel	36.65	
		353RH-MB	Matte Black	40.80	
		P			
	<ul style="list-style-type: none"> • Towel Ring • Coordinates with Dia and Identity collections • Durable mounting system • Metal construction 	353TR	Chrome	55.75	
		353TR-STN	Satin Nickel	72.40	
		353TR-MB	Matte Black	83.80	
		P			
	<ul style="list-style-type: none"> • Toilet Paper Holder • Coordinates with Dia and Identity collections • Durable mounting system • Metal construction 	353TP	Chrome	53.65	
		353TP-STN	Satin Nickel	69.80	
		353TP-MB	Matte Black	79.95	
		P			

Verity™ Collection

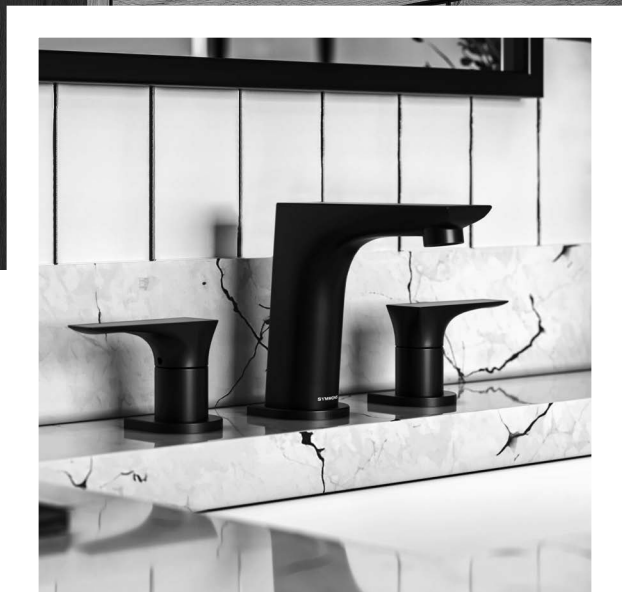

The Verity Collection merges a sleek, geometric design with subtle circular elements for a sophisticated upscale look. Verity's modern silhouette and clean lines serve as a focal point in contemporary bath spaces.

Available in these finishes:

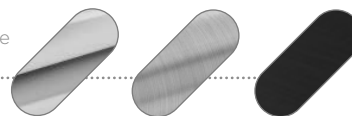





Polished
Chrome

Satin Nickel
Radiance® PVD
(STN)

Matte
Black
(MB)

Faucets • Tub/Showers • Accessories









Verity® Lavatory Faucets

	DESCRIPTION	MODEL	FINISH	PRICE
	• Verity Single Handle Lavatory Faucet	SLS4912PP	Chrome	330.40
	• Single-hole installation	SLS4912STNPP	Satin Nickel	429.55
	• 6-3/16" height	SLS4912MBPP	Matte Black	462.55
	• 3/8" braided hose connections			
	• Ceramic cartridges			
	• Metal construction			
	• Metal push-pop drain assembly included			
	• 1.0 gpm (3.8 L/min) flow rate			
				
	• Verity Widespread Lavatory Faucet	SLW4912PP	Chrome	415.80
	• 3-hole installation with 8-16" center	SLW4912STNPP	Satin Nickel	540.50
	• 5-7/16" spout height	SLW4912MBPP	Matte Black	581.90
	• Threadless valve-to-spout connections			
	• 3/8" braided hose connections			
	• Ceramic cartridges			
	• Metal push-pop drain assembly included			
	• 1.0 gpm (3.8 L/min) flow rate			
				

Modifications for Verity Lavatory Faucets

SUFFIX	DESCRIPTION	CHROME	STN	MB
05	 0.5 gpm (1.9 L/min) flow restrictor	N/A	N/A	N/A

Verity® Shower and Tub/Shower

	DESCRIPTION	MODEL	FINISH	PRICE			
	<ul style="list-style-type: none"> • Verity Shower Trim with VersaFlex Integral Diverter/Volume Control • 7" HydroMersion showerhead with Total spray • EverFlow rubber spray nozzles • VersaFlex Integral Diverter/Volume Control lever • Metal handle • Red and blue indicators on escutcheon • 2.0 gpm (7.6 L/min) flow rate 	<i>Trim Only: S26 Series Temptrol® valve required (see page 151)</i> S4991TRM S4991STNTRM S4991MBTRM <i>Trim Only with flow control spindle and cap nut: S16 Series Temptrol® valve required (see page 151)</i> S4991TRMTC S4991STNTRMTC S4991MBTRMTC	Chrome Satin Nickel Matte Black Chrome Satin Nickel Matte Black	293.30 379.05 410.70 370.80 456.55 488.20			
	WS P 						
		<ul style="list-style-type: none"> • Verity Shower Trim • 7" HydroMersion showerhead with Total spray • EverFlow rubber spray nozzles • Metal handle • 2.0 gpm (7.6 L/min) flow rate • Red and blue indicators on escutcheon 	<i>Trim Only: 26 Series Temptrol® valve required (see page 139)</i> 4991TRM 4991STNTRM 4991MBTRM <i>Trim Only with flow control spindle and cap nut: 16 Series Temptrol® valve required (see page 139)</i> 4991TRMTC 4991STNTRMTC 4991MBTRMTC	Chrome Satin Nickel Matte Black Chrome Satin Nickel Matte Black	224.30 281.75 313.90 301.80 359.25 391.40		
		WS P 					
			<ul style="list-style-type: none"> • Verity Tub and Shower Trim with VersaFlex Integral Diverter • 7" HydroMersion showerhead with Total spray • EverFlow rubber spray nozzles • VersaFlex Integral Diverter lever • 5-1/2" slip-on non-diverter tub spout • Metal handle • Red and blue indicators on escutcheon • 2.0 gpm (7.6 L/min) flow rate 	<i>Trim Only: S26 Series Temptrol® valve required (see page 147)</i> S4992TRM S4992STNTRM S4992MBTRM <i>Trim Only with flow control spindle and cap nut: S16 Series Temptrol® valve required (see page 147)</i> S4992TRMTC S4992STNTRMTC S4992MBTRMTC	Chrome Satin Nickel Matte Black Chrome Satin Nickel Matte Black	315.65 410.05 441.90 393.15 487.55 519.40	
			WS P 				
				<ul style="list-style-type: none"> • Verity Tub and Shower Trim • 7" HydroMersion showerhead with Total spray • EverFlow rubber spray nozzles • 5-1/2" slip-on diverter tub spout • Metal handle • Red and blue indicators on escutcheon • 2.0 gpm (7.6 L/min) flow rate 	<i>Trim Only: 26 Series Temptrol® valve required (see page 139)</i> 4992TRM 4992STNTRM 4992MBTRM <i>Trim Only with flow control spindle and cap nut: 16 Series Temptrol® valve required (see page 139)</i> 4992TRMTC 4992STNTRMTC 4992MBTRMTC	Chrome Satin Nickel Matte Black Chrome Satin Nickel Matte Black	238.25 301.40 333.55 315.75 378.90 411.05
				WS P 			

Verity® Shower and Tub/Shower



DESCRIPTION	MODEL	FINISH	PRICE
<ul style="list-style-type: none"> • Verity Hand Shower Trim • 2-1/2" x 4-1/2" HydroMersion hand shower wand with Total spray and push-button Pause mode • EverFlow rubber spray nozzles • 30" hand shower slide bar • 60" flexible metal hose • Metal handle • Red and blue indicators on escutcheon • 2.0 gpm (7.6 L/min) flow rate 	<i>Trim Only: 26 Series Temptrol® valve required (see page 139)</i>		
	4993TRM	Chrome	555.10
	4993STNTRM	Satin Nickel	745.05
	4993MBTRM	Matte Black	777.15
	<i>Trim Only with flow control spindle and cap nut: 16 Series Temptrol® valve required (see page 139)</i>		
	4993TRMTC	Chrome	632.60
	4993STNTRMTC	Satin Nickel	822.55
	4993MBTRMTC	Matte Black	854.65



<ul style="list-style-type: none"> • Verity Tub and Hand Shower Trim with VersaFlex Integral Diverter • 2-1/2" x 4-1/2" HydroMersion hand shower wand with Total spray and push-button Pause mode • EverFlow rubber spray nozzles • VersaFlex Integral Diverter lever • 5-1/2" slip-on non-diverter tub spout • 30" hand shower slide bar • 60" flexible metal hose • Metal handle • Red and blue indicators on escutcheon • 2.0 gpm (7.6 L/min) flow rate 	<i>Trim Only: S26 Series Temptrol® valve required (see page 147)</i>		
	S4994TRM	Chrome	633.55
	S4994STNTRM	Satin Nickel	855.10
	S4994MBTRM	Matte Black	886.90
	<i>Trim Only with flow control spindle and cap nut: S16 Series Temptrol® valve required (see page 147)</i>		
	S4994TRMTC	Chrome	711.05
	S4994STNTRMTC	Satin Nickel	932.60
	S4994MBTRMTC	Matte Black	964.40



<ul style="list-style-type: none"> • Verity Shower and Hand Shower Trim with VersaFlex Integral Diverter • 7" HydroMersion showerhead with Total spray • 2-1/2" x 4-1/2" HydroMersion hand shower wand with Total spray and push-button Pause mode • EverFlow rubber spray nozzles • VersaFlex Integral Diverter lever • 30" hand shower slide bar • 60" flexible metal hose • Metal handle • Red and blue indicators on escutcheon • 2.0 gpm (7.6 L/min) flow rate 	<i>Trim Only: S26 Series Temptrol® valve required (see page 147)</i>		
	S4998TRM	Chrome	595.55
	S4998STNTRM	Satin Nickel	800.25
	S4998MBTRM	Matte Black	833.60
	<i>Trim Only with flow control spindle and cap nut: S16 Series Temptrol® valve required (see page 147)</i>		
	S4998TRMTC	Chrome	673.05
	S4998STNTRMTC	Satin Nickel	877.75
	S4998MBTRMTC	Matte Black	911.10



Verity® Shower and Tub/Shower



DESCRIPTION	MODEL	FINISH	PRICE
	<i>Trim Only: 26 Series Temptrol® and 2DIV Series valves required (see pages 139 and 158)</i>		
• Verity Shower and Hand Shower Trim	4995TRM	Chrome	765.75
• 7" HydroMersion showerhead with Total spray	4995STNTRM	Satin Nickel	1039.90
• 2-1/2" x 4-1/2" HydroMersion hand shower wand with Total spray and push-button Pause mode	4995MBTRM	Matte Black	1072.10
	<i>Trim Only with flow control spindle and cap nut: 16 Series Temptrol® and 2DIV Series valves required (see pages 139 and 158)</i>		
• Separate dual outlet diverter trim	4995TRMTC	Chrome	843.25
• EverFlow rubber spray nozzles	4995STNTRMTC	Satin Nickel	1117.40
• 30" hand shower slide bar	4995MBTRMTC	Matte Black	1149.60
• 60" flexible metal hose			
• Metal handle			
• Red and blue indicators on escutcheon			
• 2.0 gpm (7.6 L/min) flow rate			



	<i>Trim Only: 26 Series Temptrol® and 3DIV Series valves required (see pages 139 and 158)</i>		
• Verity Shower System Trim	4996TRM	Chrome	793.20
• 7" HydroMersion showerhead with Total spray	4996STNTRM	Satin Nickel	1078.60
• 2-1/2" x 4-1/2" HydroMersion hand shower wand with Total spray and push-button Pause mode	4996MBTRM	Matte Black	1110.60
	<i>Trim Only with flow control spindle and cap nut: 16 Series Temptrol® and 3DIV Series valves required (see pages 139 and 158)</i>		
• EverFlow rubber spray nozzles	4996TRMTC	Chrome	870.70
• Separate triple outlet diverter trim	4996STNTRMTC	Satin Nickel	1156.10
• 30" hand shower slide bar	499MBTRMTC	Matte Black	1188.10
• 60" flexible metal hose			
• 5-1/2" slip-on non-diverter tub spout			
• Metal handle			
• Red and blue indicators on escutcheon			
• 2.0 gpm (7.6 L/min) flow rate			



	<i>Trim Only: S26 Series Temptrol® valve required (see pages 147 and 151)</i>		
• Verity Shower Valve Trim with VersaFlex Integral Diverter/Volume Control	S4990TRM	Chrome	238.15
• VersaFlex Integral Diverter/Volume Control lever	S4990STNTRM	Satin Nickel	301.55
	S4990MBTRM	Matte Black	333.45
• Metal handle	<i>Trim Only with flow control spindle and cap nut: S16 Series Temptrol® valve required (see pages 147 and 151)</i>		
• Red and blue indicators on escutcheon	S4990TRMTC	Chrome	315.65
	S4990STNTRMTC	Satin Nickel	379.05
	S4990MBTRMTC	Matte Black	410.95

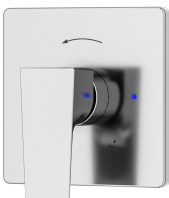

	<i>Trim Only: 26 Series Temptrol® valve required (see page 139)</i>		
• Verity Shower Valve Trim	4990TRM	Chrome	178.25
• Metal handle	4990STNTRM	Satin Nickel	217.15
• Red and blue indicators on escutcheon	4990MBTRM	Matte Black	249.45
	<i>Trim Only with flow control spindle and cap nut: 16 Series Temptrol® valve required (see page 139)</i>		
	4990TRMTC	Chrome	255.75
	4990STNTRMTC	Satin Nickel	294.65
	4990MBTRMTC	Matte Black	326.95



Modifications for Verity Showers and Tub/Shower Systems

SUFFIX	DESCRIPTION	CHROME	STN	MB
15	 1.5 gpm (5.7 L/min) flow restrictor	N/A	N/A	N/A
L1	Less showerhead	-29.60	-38.50	-41.40
L2	Less hand shower	-58.20	-75.70	-81.55
L3	Less showerhead and hand shower	-87.75	-114.20	-123.00
L4	Less showerhead, arm and flange	-71.50	-92.90	-100.05
L5	Less hand shower system	-201.15	-218.60	-224.45
L6	Less tub spout (for non diverter tub spout, deduct this line)	-30.45	-39.55	-42.60
L6.	Less tub spout (for diverter tub spout, deduct this line)	-46.70	-60.65	-65.25
L7	Less handle	-25.75	-33.45	-36.00

Verity® Shower and Tub/Shower Accessories



DESCRIPTION	MODEL	FINISH	PRICE
	<i>2.0 gpm (7.6 L/min) standard</i>		
• Single-Function Showerhead	491SH	Chrome	74.05
• Standard on the Verity collection	491SHSTN	Satin Nickel	96.30
• 7" square	491SHMB	Matte Black	103.60
• HydroMersion technology for increased force	<i>1,5 gpm (5.7 L/min) CALGreen</i>		
• EverFlow rubber spray nozzles	491SH15	Chrome	74.05
• Total spray for complete coverage	491SHSTN15	Satin Nickel	96.30
• Solid brass ball joint	491SHMB15	Matte Black	103.60
• Contemporary/Modern style			







	<i>2.0 gpm (7.6 L/min) standard</i>		
• Single-Function Hand Shower Wand	482WSQ	Chrome	145.50
• Standard on the Duro and Verity collections	482WSQSTN	Satin Nickel	189.20
• 2-1/2" x 4-1/2" spray head	482WSQMB	Matte Black	203.80
• HydroMersion technology for increased force	482WSQBBZ	Brushed Bronze	203.80
	<i>1,5 gpm (5.7 L/min) CALGreen</i>		
• EverFlow rubber spray nozzles	482WSQ15	Chrome	145.50
• Total spray for complete coverage	482WSQSTN15	Satin Nickel	189.20
• Push-button Pause mode for non-positive shutoff	482WSQMB15	Matte Black	203.80
• Contemporary/Modern style	482WSQBBZ15	Brushed Bronze	203.80



• Single-Function Hand Shower Slide Bar System	HS521	Chrome	502.85
	HS521STN	Satin Nickel	653.70
• Coordinates with Duro and Verity collections	HS521MB	Matte Black	703.95
• 2-1/2" x 4-1/2" HydroMersion hand shower wand with Total spray and push-button Pause mode			
• EverFlow rubber spray nozzles			
• 30" hand shower slide bar			
• 60" flexible metal hose			
• Contemporary/Modern style			
• 2.0 gpm (7.6 L/min) flow rate			



Verity® Shower and Tub/Shower Accessories

	DESCRIPTION	MODEL	FINISH	PRICE		
	<ul style="list-style-type: none"> • 24" or 36" Slide/Grab Bar • 2-1/2" x 4-1/2" HydroMersion hand shower wand with Total spray and push-button Pause mode • EverFlow rubber spray nozzles • 60" flexible metal hose • 1-1/2" diameter slide bar • ADA slide mechanism • Wall elbow included • Contemporary/Modern style • 2.0 gpm (7.6 L/min) flow rate 	24" Length H36924 H36924STN H36924MB	Chrome Satin Nickel Matte Black	586.05 770.25 820.55		
		36" Length H36936 H36936STN H36936MB	Chrome Satin Nickel Matte Black	598.05 787.05 837.20		
		<ul style="list-style-type: none"> • 24" or 36" Slide/Grab Bar • Contemporary/Modern style • 4" HydroMersion hand shower wand with 7 modes • EverFlow rubber spray nozzles • 60" flexible metal hose • 1-1/2" diameter slide bar • Pause mode for non-positive shutoff • ADA slide mechanism • Wall elbow included • 2.0 gpm (7.6 L/min) flow rate 	24" Length H35924 H35924STN H35924MB	Chrome Satin Nickel Matte Black	586.05 770.25 820.45	
			36" Length H35936 H35936STN H35936MB	Chrome Satin Nickel Matte Black	598.05 787.05 834.55	
			<ul style="list-style-type: none"> • Shower Arm and Flange • Standard on Duro and Verity collections • Metal square flange • 8" length 	300SQ 300SQ-STN 300SQ-MB	Chrome Satin Nickel Matte Black	92.35 120.05 129.85
			<ul style="list-style-type: none"> • Verity Tub Spout • 5-1/2" length • Metal construction • Slip-on installation 	493TS 493TSSTN 493TSMB	Chrome Satin Nickel Matte Black	76.05 98.85 106.50
		<ul style="list-style-type: none"> • Verity Diverter Tub Spout • 5-1/2" length • Pull-up diverter • Metal construction • Slip-on installation 	493DTS 493DTSSTN 493DTSMB	Chrome Satin Nickel Matte Black	116.65 151.75 163.40	

Verity® Shower and Tub/Shower Accessories







DESCRIPTION	MODEL	FINISH	PRICE
<ul style="list-style-type: none"> • Verity Diverter Valve Trim • 5" square • Metal handle • Screwless escutcheon • Dual or triple outlet 	<i>Trim Only: 2DIV-BODY or 3DIV-BODY required (see page 158)</i>		
	49DIVTRM	Chrome	232.15
	49DIVSTNTRM	Satin Nickel	301.80
	49DIVMBTRM	Matte Black	325.05



Modifications for Verity Shower and Tub/Shower Accessories

SUFFIX	DESCRIPTION	CHROME	STN	MB
15	1.5 gpm (5.7 L/min) flow restrictor	N/A	N/A	N/A

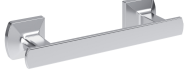
Verity® Bath Accessories

	DESCRIPTION	MODEL	FINISH	PRICE
	<ul style="list-style-type: none"> • 18" or 24" Towel Bar • Coordinates with the Verity collection • Durable mounting system • Metal construction 	<i>18" Length</i>		
		493TB18	Chrome	107.30
		493TB18STN	Satin Nickel	139.40
		493TB18MB	Matte Black	150.20
		<i>24" Length</i>		
		493TB24	Chrome	122.55
		493TB24STN	Satin Nickel	159.35
		493TB24MB	Matte Black	171.60
			<ul style="list-style-type: none"> • Robe Hook • Coordinates with the Verity collection • Durable mounting system • Metal construction 	493RH
493RHSTN	Satin Nickel			36.75
493RHMB	Matte Black			39.45
P				
	<ul style="list-style-type: none"> • Towel Holder • Coordinates with the Verity collection • Durable mounting system • Metal construction 	493TR	Chrome	50.55
		493TRSTN	Satin Nickel	65.70
		493TRMB	Matte Black	70.85
		P		
	<ul style="list-style-type: none"> • Toilet Paper Holder • Coordinates with the Verity collection • Durable mounting system • Metal construction 	493TP	Chrome	56.10
		493TPSTN	Satin Nickel	73.00
		493TPMB	Matte Black	78.60
		P		



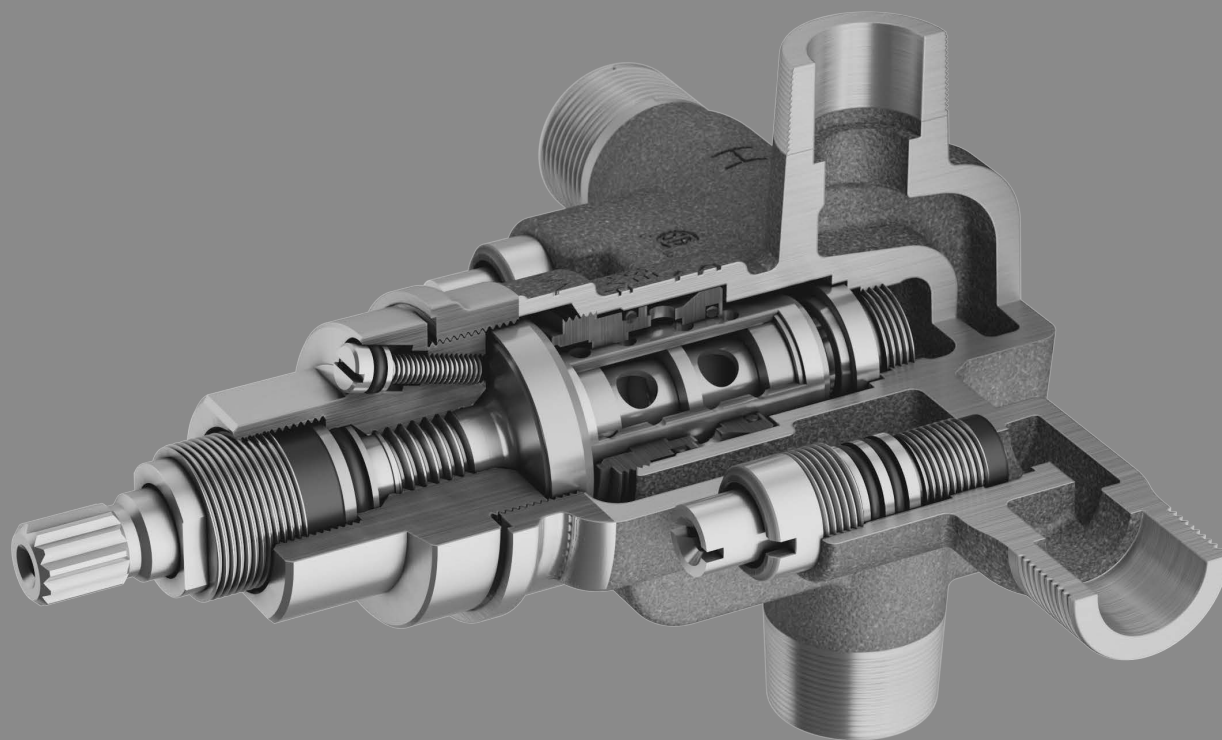





Tub/Shower Valve Bodies

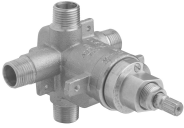

Symmons pressure-balancing shower and tub/shower valves instantly react to disturbances in water pressure to maintain safe shower temperatures. All functioning valve parts are brass, bronze and stainless steel delivering maximum durability and reliable performance. Symmons pressure-balancing valves have been the trusted choice for customers for over 85 years.

Shower and Tub/Shower Valve Bodies

Temptrol® Tub/Shower Valves



DESCRIPTION	MODEL	EASYSERVICE™ STOPS	PRICE
 <ul style="list-style-type: none"> Temptrol Pressure-Balancing Tub/Shower Valve Body Adjustable stop screw to limit handle turn 1/2" Universal (1/2" NPT and direct sweat) inlets/outlet Solid brass, bronze, and stainless steel construction 	Standard		
	262BODY	Not Included	154.90
	262XBODY	Included	182.40
	<i>Includes Reverse Seat for Back-to-Back Installation</i>		
	262RVBODY	Not Included	154.90
	262XRVBODY	Included	182.40
	<i>Includes ProSafe™ Test Cap in place of flow control spindle and cap nut</i>		
	162BODY	Not Included	77.45
	162XBODY	Included	105.00
	<i>Includes ProSafe™ Test Cap in place of flow control spindle and cap nut; Includes Reverse Seat for Back-to-Back Installation</i>		
	162RVBODY	Not Included	77.45
	162XRVBODY	Included	105.00
 <ul style="list-style-type: none"> Temptrol Pressure-Balancing Tub/Shower Valve Body Adjustable stop screw to limit handle turn 1/2" Universal (1/2" NPT and direct sweat) inlets/outlet CPVC inlet fittings Solid brass, bronze, and stainless steel construction 	Standard		
	262CPBODY	Not Included	174.80
	262XCPBODY	Included	202.25
	<i>Includes Reverse Seat for Back-to-Back Installation</i>		
	262RVCPBODY	Not Included	174.80
	262XRVCPCBODY	Included	202.25
	<i>Includes ProSafe™ Test Cap in place of flow control spindle and cap nut</i>		
	162CPBODY	Not Included	97.40
	162XCPBODY	Included	124.85
	<i>Includes ProSafe™ Test Cap in place of flow control spindle and cap nut; Includes Reverse Seat for Back-to-Back Installation</i>		
	162RVCPBODY	Not Included	97.40
	162XRVCPCBODY	Included	124.85
 <ul style="list-style-type: none"> Temptrol Pressure-Balancing Tub/Shower Valve Body Adjustable stop screw to limit handle turn 1/2" Universal (1/2" NPT and direct sweat) inlets/outlet PEX crimp inlet fittings Solid brass, bronze, and stainless steel construction 	Standard		
	262P1BODY	Not Included	174.80
	262XP1BODY	Included	202.25
	<i>Includes Reverse Seat for Back-to-Back Installation</i>		
	262RVP1BODY	Not Included	174.80
	262XRVP1BODY	Included	202.25
	<i>Includes ProSafe™ Test Cap in place of flow control spindle and cap nut</i>		
	162P1BODY	Not Included	97.40
	162XP1BODY	Included	124.85
	<i>Includes ProSafe™ Test Cap in place of flow control spindle and cap nut; Includes Reverse Seat for Back-to-Back Installation</i>		
	162RVP1BODY	Not Included	97.40
	162XRVP1BODY	Included	124.85
 <ul style="list-style-type: none"> Temptrol Pressure-Balancing Tub/Shower Valve Body Adjustable stop screw to limit handle turn 1/2" Universal (1/2" NPT and direct sweat) inlets/outlet PEX cold expansion inlet fittings Solid brass, bronze, and stainless steel construction 	Standard		
	262P2BODY	Not Included	174.80
	262XP2BODY	Included	202.25
	<i>Includes Reverse Seat for Back-to-Back Installation</i>		
	262RVP2BODY	Not Included	174.80
	262XRVP2BODY	Included	202.25
	<i>Includes ProSafe™ Test Cap in place of flow control spindle and cap nut</i>		
	162P2BODY	Not Included	97.40
	162XP2BODY	Included	124.85
	<i>Includes ProSafe™ Test Cap in place of flow control spindle and cap nut; Includes Reverse Seat for Back-to-Back Installation</i>		
	162RVP2BODY	Not Included	97.40
	162XRVP2BODY	Included	124.85

Temptrol® Tub/Shower Valves





DESCRIPTION	MODEL	EASYSERVICE™ STOPS	PRICE
<ul style="list-style-type: none"> Temptrol Pressure-Balancing Tub/Shower Valve Body Adjustable stop screw to limit handle turn 1/2" Universal (1/2" NPT and direct sweat) inlets/outlet ProPress® stub out inlet fittings Solid brass, bronze, and stainless steel construction 	<i>Standard</i>		
	262P3BODY	Not Included	210.55
	262XP3BODY	Included	238.10
	<i>Includes Reverse Seat for Back-to-Back Installation</i>		
	262RVP3BODY	Not Included	210.55
	262XRVP3BODY	Included	238.10
	<i>Includes ProSafe™ Test Cap in place of flow control spindle and cap nut</i>		
	162P3BODY	Not Included	133.10
	162XP3BODY	Included	160.65
	<i>Includes ProSafe™ Test Cap in place of flow control spindle and cap nut; Includes Reverse Seat for Back-to-Back Installation</i>		
	162RVP3BODY	Not Included	133.10
	162XRVP3BODY	Included	160.65

Temptrol Rapid Install™ Tub/Shower Valves









DESCRIPTION	MODEL	EASYSERVICE™ STOPS	PRICE	
 <ul style="list-style-type: none"> Temptrol Rapid Install Pressure-Balancing Tub/Shower Valve Body Adjustable stop screw to limit handle turn 1/2" Universal (1/2" NPT and direct sweat) inlets/outlet Nylon Rapid Install bracket with 4 straps included Solid brass, bronze, and stainless steel valve body construction 	<i>Standard</i>			
	262BRBODY	Not Included	202.70	
	262XBRBODY	Included	230.10	
	<i>Includes Reverse Seat for Back-to-Back Installation</i>			
	262RVBRBODY	Not Included	202.70	
	262XRBRBODY	Included	230.10	
	<i>Includes ProSafe™ Test Cap in place of flow control spindle and cap nut</i>			
	162BRBODY	Not Included	125.15	
	162XBRBODY	Included	152.70	
	<i>Includes ProSafe™ Test Cap in place of flow control spindle and cap nut; Includes Reverse Seat for Back-to-Back Installation</i>			
	162RVBRBODY	Not Included	125.15	
	162XRBRBODY	Included	152.70	
 <ul style="list-style-type: none"> Temptrol Rapid Install Pressure-Balancing Tub/Shower Valve Body Adjustable stop screw to limit handle turn 1/2" Universal (1/2" NPT and direct sweat) inlets/outlet CPVC inlet fittings Nylon Rapid Install bracket with 4 straps included Solid brass, bronze, and stainless steel valve body construction 	<i>Standard</i>			
	262CPBRBODY	Not Included	222.55	
	262XCPBRBODY	Included	250.05	
	<i>Includes Reverse Seat for Back-to-Back Installation</i>			
	262RVCPBRBODY	Not Included	222.55	
	262XRCPBRBODY	Included	250.05	
	<i>Includes ProSafe™ Test Cap in place of flow control spindle and cap nut</i>			
	162CPBRBODY	Not Included	145.05	
	162XCPBRBODY	Included	172.65	
	<i>Includes ProSafe™ Test Cap in place of flow control spindle and cap nut; Includes Reverse Seat for Back-to-Back Installation</i>			
	162RVCPBRBODY	Not Included	145.05	
	162XRCPBRBODY	Included	172.65	
 <ul style="list-style-type: none"> Temptrol Rapid Install Pressure-Balancing Tub/Shower Valve Body Adjustable stop screw to limit handle turn 1/2" Universal (1/2" NPT and direct sweat) inlets/outlet PEX crimp inlet fittings Nylon Rapid Install bracket with 4 straps included Solid brass, bronze, and stainless steel valve body construction 	<i>Standard</i>			
	262P1BRBODY	Not Included	222.55	
	262XP1BRBODY	Included	250.05	
	<i>Includes Reverse Seat for Back-to-Back Installation</i>			
	262RVP1BRBODY	Not Included	222.55	
	262XRVP1BRBODY	Included	250.05	
	<i>Includes ProSafe™ Test Cap in place of flow control spindle and cap nut</i>			
	162P1BRBODY	Not Included	145.05	
	162XP1BRBODY	Included	172.65	
	<i>Includes ProSafe™ Test Cap in place of flow control spindle and cap nut; Includes Reverse Seat for Back-to-Back Installation</i>			
	162RVP1BRBODY	Not Included	145.05	
	162XRVP1BRBODY	Included	172.65	

Temptrol Rapid Install™ Tub/Shower Valves

DESCRIPTION	MODEL	EASYSERVICE™ STOPS	PRICE
 <ul style="list-style-type: none"> Temptrol Rapid Install Pressure-Balancing Tub/Shower Valve Body Adjustable stop screw to limit handle turn 1/2" Universal (1/2" NPT and direct sweat) inlets/outlet PEX cold expansion inlet fittings Nylon Rapid Install bracket with 4 straps included Solid brass, bronze, and stainless steel valve body construction 	<i>Standard</i>		
	262P2BRBODY	Not Included	222.55
	262XP2BRBODY	Included	250.05
	<i>Includes Reverse Seat for Back-to-Back Installation</i>		
	262RVP2BRBODY	Not Included	222.55
	262XRVP2BRBODY	Included	250.05
	<i>Includes ProSafe™ Test Cap in place of flow control spindle and cap nut</i>		
	162P2BRBODY	Not Included	145.05
	162XP2BRBODY	Included	172.65
	<i>Includes ProSafe™ Test Cap in place of flow control spindle and cap nut; Includes Reverse Seat for Back-to-Back Installation</i>		
	162RVP2BRBODY	Not Included	145.05
	162XRVP2BRBODY	Included	172.65
 <ul style="list-style-type: none"> Temptrol Rapid Install Pressure-Balancing Tub/Shower Valve Body Adjustable stop screw to limit handle turn 1/2" Universal (1/2" NPT and direct sweat) inlets/outlet ProPress® stub out inlet fittings Nylon Rapid Install bracket with 4 straps included Solid brass, bronze, and stainless steel valve body construction 	<i>Standard</i>		
	262P3BRBODY	Not Included	258.25
	262XP3BRBODY	Included	285.80
	<i>Includes Reverse Seat for Back-to-Back Installation</i>		
	262RVP3BRBODY	Not Included	258.25
	262XRVP3BRBODY	Included	285.80
	<i>Includes ProSafe™ Test Cap in place of flow control spindle and cap nut</i>		
	162P3BRBODY	Not Included	180.75
	162XP3BRBODY	Included	208.35
	<i>Includes ProSafe™ Test Cap in place of flow control spindle and cap nut; Includes Reverse Seat for Back-to-Back Installation</i>		
	162RVP3BRBODY	Not Included	180.75
	162XRVP3BRBODY	Included	208.35



Temptrol® Shower Valves

DESCRIPTION	MODEL	EASYSERVICE™ STOPS	PRICE
 <ul style="list-style-type: none"> Temptrol Pressure-Balancing Shower Valve Body Adjustable stop screw to limit handle turn 1/2" Universal (1/2" NPT and direct sweat) inlets/outlet Built-in service stops Solid brass, bronze, and stainless steel construction 	Standard		
	261XBODY	Included	182.40
	<i>Includes Reverse Seat for Back-to-Back Installation</i>		
	261XRVBODY	Included	182.40
	<i>Includes ProSafe™ Test Cap in place of flow control spindle and cap nut</i>		
	161XBODY	Included	105.00
<i>Includes ProSafe™ Test Cap in place of flow control spindle and cap nut; Includes Reverse Seat for Back-to-Back Installation</i>			
	161XRVBODY	Included	105.00
			
 <ul style="list-style-type: none"> Temptrol Pressure-Balancing Shower Valve Body Adjustable stop screw to limit handle turn 1/2" Universal (1/2" NPT and direct sweat) inlets/outlet Built-in service stops CPVC inlet fittings Solid brass, bronze, and stainless steel construction 	Standard		
	261XCPBODY	Included	202.25
	<i>Includes Reverse Seat for Back-to-Back Installation</i>		
	261XRVCPCBODY	Included	202.25
	<i>Includes ProSafe™ Test Cap in place of flow control spindle and cap nut</i>		
	161XCPBODY	Included	124.85
<i>Includes ProSafe™ Test Cap in place of flow control spindle and cap nut; Includes Reverse Seat for Back-to-Back Installation</i>			
	161XRVCPCBODY	Included	124.85
			
 <ul style="list-style-type: none"> Temptrol Pressure-Balancing Shower Valve Body Adjustable stop screw to limit handle turn 1/2" Universal (1/2" NPT and direct sweat) inlets/outlet Built-in service stops PEX crimp inlet fittings Solid brass, bronze, and stainless steel construction 	Standard		
	261XP1BODY	Included	202.25
	<i>Includes Reverse Seat for Back-to-Back Installation</i>		
	261XRVP1BODY	Included	202.25
	<i>Includes ProSafe™ Test Cap in place of flow control spindle and cap nut</i>		
	161XP1BODY	Included	124.85
<i>Includes ProSafe™ Test Cap in place of flow control spindle and cap nut; Includes Reverse Seat for Back-to-Back Installation</i>			
	161XRVP1BODY	Included	124.85
			
 <ul style="list-style-type: none"> Temptrol Pressure-Balancing Shower Valve Body Adjustable stop screw to limit handle turn 1/2" Universal (1/2" NPT and direct sweat) inlets/outlet Built-in service stops PEX cold expansion inlet fittings Solid brass, bronze, and stainless steel construction 	Standard		
	261XP2BODY	Included	202.25
	<i>Includes Reverse Seat for Back-to-Back Installation</i>		
	261XRVP2BODY	Included	202.25
	<i>Includes ProSafe™ Test Cap in place of flow control spindle and cap nut</i>		
	161XP2BODY	Included	124.85
<i>Includes ProSafe™ Test Cap in place of flow control spindle and cap nut; Includes Reverse Seat for Back-to-Back Installation</i>			
	161XRVP2BODY	Included	124.85
			







Temptrol® Shower Valves





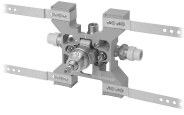

DESCRIPTION	MODEL	EASYSERVICE™ STOPS	PRICE
<ul style="list-style-type: none"> • Temptrol Pressure-Balancing Shower Valve Body • Adjustable stop screw to limit handle turn • 1/2" Universal (1/2" NPT and direct sweat) inlets/outlet • Built-in service stops • ProPress® stub out inlet fittings • Solid brass, bronze, and stainless steel construction 	<i>Standard</i>		
	261XP3BODY	Included	238.10
	<i>Includes Reverse Seat for Back-to-Back Installation</i>		
	261XRVP3BODY	Included	238.10
	<i>Includes ProSafe™ Test Cap in place of flow control spindle and cap nut</i>		
	161XP3BODY	Included	160.65
<i>Includes ProSafe™ Test Cap in place of flow control spindle and cap nut; Includes Reverse Seat for Back-to-Back Installation</i>			
	161XRVP3BODY	Included	160.65



Temptrol Rapid Install™ Shower Valves

DESCRIPTION	MODEL	EASYSERVICE™ STOPS	PRICE
 <ul style="list-style-type: none"> Temptrol Rapid Install Pressure-Balancing Shower Valve Body Adjustable stop screw to limit handle turn 1/2" Universal (1/2" NPT and direct sweat) inlets/outlet Built-in service stops Nylon Rapid Install bracket with 4 straps included Solid brass, bronze, and stainless steel valve body construction 	<i>Standard</i>		
	261XBRBODY	Included	230.10
	<i>Includes Reverse Seat for Back-to-Back Installation</i>		
	261XRVBRBODY	Included	230.10
	<i>Includes ProSafe™ Test Cap in place of flow control spindle and cap nut</i>		
	161XBRBODY	Included	152.70
<i>Includes ProSafe™ Test Cap in place of flow control spindle and cap nut; Includes Reverse Seat for Back-to-Back Installation</i>			
	161XRVBRBODY	Included	152.70
			
 <ul style="list-style-type: none"> Temptrol Rapid Install Pressure-Balancing Shower Valve Body Adjustable stop screw to limit handle turn 1/2" Universal (1/2" NPT and direct sweat) inlets/outlet Built-in service stops CPVC inlet fittings Nylon Rapid Install bracket with 4 straps included Solid brass, bronze, and stainless steel valve body construction 	<i>Standard</i>		
	261XCPBRBODY	Included	250.05
	<i>Includes Reverse Seat for Back-to-Back Installation</i>		
	261XRVCPRBODY	Included	250.05
	<i>Includes ProSafe™ Test Cap in place of flow control spindle and cap nut</i>		
	161XCPBRBODY	Included	172.65
<i>Includes ProSafe™ Test Cap in place of flow control spindle and cap nut; Includes Reverse Seat for Back-to-Back Installation</i>			
	161XRVCPRBODY	Included	172.65
			
 <ul style="list-style-type: none"> Temptrol Rapid Install Pressure-Balancing Shower Valve Body Adjustable stop screw to limit handle turn 1/2" Universal (1/2" NPT and direct sweat) inlets/outlet Built-in service stops PEX crimp inlet fittings Nylon Rapid Install bracket with 4 straps included Solid brass, bronze, and stainless steel valve body construction 	<i>Standard</i>		
	261XP1BRBODY	Included	250.05
	<i>Includes Reverse Seat for Back-to-Back Installation</i>		
	261XRVP1BRBODY	Included	250.05
	<i>Includes ProSafe™ Test Cap in place of flow control spindle and cap nut</i>		
	161XP1BRBODY	Included	172.65
<i>Includes ProSafe™ Test Cap in place of flow control spindle and cap nut; Includes Reverse Seat for Back-to-Back Installation</i>			
	161XRVP1BRBODY	Included	172.65
			

Temptrol Rapid Install™ Shower Valves

DESCRIPTION	MODEL	EASYSERVICE™ STOPS	PRICE
 <ul style="list-style-type: none"> Temptrol Rapid Install Pressure-Balancing Shower Valve Body Adjustable stop screw to limit handle turn 1/2" Universal (1/2" NPT and direct sweat) inlets/outlet Built-in service stops PEX cold expansion inlet fittings Nylon Rapid Install bracket with 4 straps included Solid brass, bronze, and stainless steel valve body construction 	<i>Standard</i>		
	261XP2BRBODY	Included	250.05
	<i>Includes Reverse Seat for Back-to-Back Installation</i>		
	261XRVP2BRBODY	Included	250.05
	<i>Includes ProSafe™ Test Cap in place of flow control spindle and cap nut</i>		
	161XP2BRBODY	Included	172.65
<i>Includes ProSafe™ Test Cap in place of flow control spindle and cap nut; Includes Reverse Seat for Back-to-Back Installation</i>			
	161XRVP2BRBODY	Included	172.65
			
 <ul style="list-style-type: none"> Temptrol Rapid Install Pressure-Balancing Shower Valve Body Adjustable stop screw to limit handle turn 1/2" Universal (1/2" NPT and direct sweat) inlets/outlet Built-in service stops ProPress® stub out inlet fittings Nylon Rapid Install bracket with 4 straps included Solid brass, bronze, and stainless steel valve body construction 	<i>Standard</i>		
	261XP3BRBODY	Included	285.80
	<i>Includes Reverse Seat for Back-to-Back Installation</i>		
	261XRVP3BRBODY	Included	285.80
	<i>Includes ProSafe™ Test Cap in place of flow control spindle and cap nut</i>		
	161XP3BRBODY	Included	208.35
<i>Includes ProSafe™ Test Cap in place of flow control spindle and cap nut; Includes Reverse Seat for Back-to-Back Installation</i>			
	161XRVP3BRBODY	Included	208.35
			

Temptrol® Tub/Shower Valves with VersaFlex™ Integral Diverter

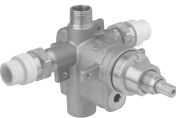
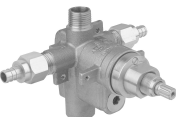
DESCRIPTION	MODEL	EASYSERVICE™ STOPS	PRICE
 <ul style="list-style-type: none"> Temptrol Pressure-Balancing Tub/Shower Valve Body with VersaFlex Integral Diverter Adjustable stop screw to limit handle turn Male 1/2" NPT or direct sweat inlets and shower port Female 1/2" NPT tub port Stringer mounts in casting Solid brass, bronze, and stainless steel construction 	<i>Standard</i>		
	S262BODY	Not Included	168.60
	S262XBODY	Included	196.20
	<i>Includes Reverse Seat for Back-to-Back Installation</i>		
	S262RVBODY	Not Included	168.60
	S262XRVBODY	Included	196.20
	<i>Includes ProSafe™ Test Cap in place of flow control spindle and cap nut</i>		
	S162BODY	Not Included	91.15
	S162XBODY	Included	118.60
	<i>Includes ProSafe™ Test Cap in place of flow control spindle and cap nut; Includes Reverse Seat for Back-to-Back Installation</i>		
	S162RVBODY	Not Included	91.15
	S162XRVBODY	Included	118.60
 <ul style="list-style-type: none"> Temptrol Pressure-Balancing Tub/Shower Valve Body with VersaFlex Integral Diverter Adjustable stop screw to limit handle turn Male 1/2" NPT or direct sweat inlets and shower port Female 1/2" NPT tub port Stringer mounts in casting CPVC inlet fittings Solid brass, bronze, and stainless steel construction 	<i>Standard</i>		
	S262CPBODY	Not Included	188.55
	S262XCPBODY	Included	216.05
	<i>Includes Reverse Seat for Back-to-Back Installation</i>		
	S262RVCPBODY	Not Included	188.55
	S262XRVCPCBODY	Included	216.05
	<i>Includes ProSafe™ Test Cap in place of flow control spindle and cap nut</i>		
	S162CPBODY	Not Included	111.10
	S162XCPBODY	Included	138.65
	<i>Includes ProSafe™ Test Cap in place of flow control spindle and cap nut; Includes Reverse Seat for Back-to-Back Installation</i>		
	S162RVCPBODY	Not Included	111.10
	S162XRVCPCBODY	Included	138.65
 <ul style="list-style-type: none"> Temptrol Pressure-Balancing Tub/Shower Valve Body with VersaFlex Integral Diverter Adjustable stop screw to limit handle turn Male 1/2" NPT or direct sweat inlets and shower port Female 1/2" NPT tub port Stringer mounts in casting PEX crimp inlet fittings Solid brass, bronze, and stainless steel construction 	<i>Standard</i>		
	S262P1BODY	Not Included	188.55
	S262XP1BODY	Included	216.05
	<i>Includes Reverse Seat for Back-to-Back Installation</i>		
	S262RVP1BODY	Not Included	188.55
	S262XRVP1BODY	Included	216.05
	<i>Includes ProSafe™ Test Cap in place of flow control spindle and cap nut</i>		
	S162P1BODY	Not Included	111.10
	S162XP1BODY	Included	138.65
	<i>Includes ProSafe™ Test Cap in place of flow control spindle and cap nut; Includes Reverse Seat for Back-to-Back Installation</i>		
	S162RVP1BODY	Not Included	111.10
	S162XRVP1BODY	Included	138.65

Temptrol® Tub/Shower Valves with VersaFlex™ Integral Diverter

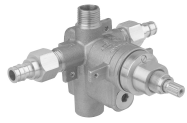



DESCRIPTION	MODEL	EASYSERVICE™ STOPS	PRICE
<ul style="list-style-type: none"> Temptrol Pressure-Balancing Tub/Shower Valve Body with VersaFlex Integral Diverter Adjustable stop screw to limit handle turn Male 1/2" NPT or direct sweat inlets and shower port Female 1/2" NPT tub port Stringer mounts in casting PEX cold expansion inlet fittings Solid brass, bronze, and stainless steel construction 	<i>Standard</i>		
	S262P2BODY	Not Included	188.55
	S262XP2BODY	Included	216.05
	<i>Includes Reverse Seat for Back-to-Back Installation</i>		
	S262RVP2BODY	Not Included	188.55
	S262XRVP2BODY	Included	216.05
	<i>Includes ProSafe™ Test Cap in place of flow control spindle and cap nut</i>		
	S162P2BODY	Not Included	111.10
	S162XP2BODY	Included	138.65
	<i>Includes ProSafe™ Test Cap in place of flow control spindle and cap nut; Includes Reverse Seat for Back-to-Back Installation</i>		
	S162RVP2BODY	Not Included	111.10
	S162XRVP2BODY	Included	138.65



<ul style="list-style-type: none"> Temptrol Pressure-Balancing Tub/Shower Valve Body with VersaFlex Integral Diverter Adjustable stop screw to limit handle turn Male 1/2" NPT or direct sweat inlets and shower port Female 1/2" NPT tub port Stringer mounts in casting ProPress® stub out inlet fittings Solid brass, bronze, and stainless steel construction 	<i>Standard</i>		
	S262P3BODY	Not Included	224.40
	S262XP3BODY	Included	251.85
	<i>Includes Reverse Seat for Back-to-Back Installation</i>		
	S262RVP3BODY	Not Included	224.40
	S262XRVP3BODY	Included	251.85
	<i>Includes ProSafe™ Test Cap in place of flow control spindle and cap nut</i>		
	S162P3BODY	Not Included	146.85
	S162XP3BODY	Included	174.35
	<i>Includes ProSafe™ Test Cap in place of flow control spindle and cap nut; Includes Reverse Seat for Back-to-Back Installation</i>		
	S162RVP3BODY	Not Included	146.85
	S162XRVP3BODY	Included	174.35



Temptrol Rapid Install™ Tub/Shower Valves with VersaFlex™ Integral Diverter

DESCRIPTION	MODEL	EASYSERVICE™ STOPS	PRICE
 <ul style="list-style-type: none"> Temptrol Rapid Install Pressure-Balancing Tub/Shower Valve Body with VersaFlex Integral Diverter Adjustable stop screw to limit handle turn Male 1/2" NPT or direct sweat inlets and shower port Female 1/2" NPT tub port Stringer mounts in casting Nylon Rapid Install bracket with 4 straps included Solid brass, bronze, and stainless steel valve body construction 	<i>Standard</i>		
	S262BRBODY	Not Included	216.30
	S262XBRBODY	Included	243.90
	<i>Includes Reverse Seat for Back-to-Back Installation</i>		
	S262RVBRBODY	Not Included	216.30
	S262XRVRBODY	Included	243.90
	<i>Includes ProSafe™ Test Cap in place of flow control spindle and cap nut</i>		
	S162BRBODY	Not Included	138.90
	S162XBRBODY	Included	166.45
	<i>Includes ProSafe™ Test Cap in place of flow control spindle and cap nut; Includes Reverse Seat for Back-to-Back Installation</i>		
	S162RVBRBODY	Not Included	138.90
	S162XRVRBODY	Included	166.45
 <ul style="list-style-type: none"> Temptrol Rapid Install Pressure-Balancing Tub/Shower Valve Body with VersaFlex Integral Diverter Adjustable stop screw to limit handle turn Male 1/2" NPT or direct sweat inlets and shower port Female 1/2" NPT tub port Stringer mounts in casting CPVC inlet fittings Nylon Rapid Install bracket with 4 straps included Solid brass, bronze, and stainless steel valve body construction 	<i>Standard</i>		
	S262CPBRBODY	Not Included	236.25
	S262XCPBRBODY	Included	263.80
	<i>Includes Reverse Seat for Back-to-Back Installation</i>		
	S262RVCPBRBODY	Not Included	236.25
	S262XRVCPRBODY	Included	263.80
	<i>Includes ProSafe™ Test Cap in place of flow control spindle and cap nut</i>		
	S162CPBRBODY	Not Included	158.80
	S162XCPBRBODY	Included	186.30
	<i>Includes ProSafe™ Test Cap in place of flow control spindle and cap nut; Includes Reverse Seat for Back-to-Back Installation</i>		
	S162RVCPBRBODY	Not Included	158.80
	S162XRVCPRBODY	Included	186.30
 <ul style="list-style-type: none"> Temptrol Rapid Install Pressure-Balancing Tub/Shower Valve Body with VersaFlex Integral Diverter Adjustable stop screw to limit handle turn Male 1/2" NPT or direct sweat inlets and shower port Female 1/2" NPT tub port Stringer mounts in casting PEX crimp inlet fittings Nylon Rapid Install bracket with 4 straps included Solid brass, bronze, and stainless steel valve body construction 	<i>Standard</i>		
	S262P1BRBODY	Not Included	236.25
	S262XP1BRBODY	Included	263.80
	<i>Includes Reverse Seat for Back-to-Back Installation</i>		
	S262RVP1BRBODY	Not Included	236.25
	S262XRVP1BRBODY	Included	263.80
	<i>Includes ProSafe™ Test Cap in place of flow control spindle and cap nut</i>		
	S162P1BRBODY	Not Included	158.80
	S162XP1BRBODY	Included	186.30
	<i>Includes ProSafe™ Test Cap in place of flow control spindle and cap nut; Includes Reverse Seat for Back-to-Back Installation</i>		
	S162RVP1BRBODY	Not Included	156.15
	S162XRVP1BRBODY	Included	186.30

Temptrol Rapid Install™ Tub/Shower Valves with VersaFlex™ Integral Diverter



DESCRIPTION	MODEL	EASYSERVICE™ STOPS	PRICE
<ul style="list-style-type: none"> Temptrol Rapid Install Pressure-Balancing Tub/Shower Valve Body with VersaFlex Integral Diverter Adjustable stop screw to limit handle turn Male 1/2" NPT or direct sweat inlets and shower port Female 1/2" NPT tub port Stringer mounts in casting PEX cold expansion inlet fittings Nylon Rapid Install bracket with 4 straps included Solid brass, bronze, and stainless steel valve body construction 	<i>Standard</i>		
	S262P2BRBODY	Not Included	236.25
	S262XP2BRBODY	Included	263.80
	<i>Includes Reverse Seat for Back-to-Back Installation</i>		
	S262RVP2BRBODY	Not Included	236.25
	S262XRVP2BRBODY	Included	263.80
	<i>Includes ProSafe™ Test Cap in place of flow control spindle and cap nut</i>		
	S162P2BRBODY	Not Included	158.80
	S162XP2BRBODY	Included	186.30
	<i>Includes ProSafe™ Test Cap in place of flow control spindle and cap nut; Includes Reverse Seat for Back-to-Back Installation</i>		
	S162RVP2BRBODY	Not Included	158.80
	S162XRVP2BRBODY	Included	186.30



<ul style="list-style-type: none"> Temptrol Rapid Install Pressure-Balancing Tub/Shower Valve Body with VersaFlex Integral Diverter Adjustable stop screw to limit handle turn Male 1/2" NPT or direct sweat inlets and shower port Female 1/2" NPT tub port Stringer mounts in casting ProPress® stub out inlet fittings Nylon Rapid Install bracket with 4 straps included Solid brass, bronze, and stainless steel valve body construction 	<i>Standard</i>		
	S262P3BRBODY	Not Included	272.00
	S262XP3BRBODY	Included	299.55
	<i>Includes Reverse Seat for Back-to-Back Installation</i>		
	S262RVP3BRBODY	Not Included	272.00
	S262XRVP3BRBODY	Included	299.55
	<i>Includes ProSafe™ Test Cap in place of flow control spindle and cap nut</i>		
	S162P3BRBODY	Not Included	194.60
	S162XP3BRBODY	Included	222.05
	<i>Includes ProSafe™ Test Cap in place of flow control spindle and cap nut; Includes Reverse Seat for Back-to-Back Installation</i>		
	S162RVP3BRBODY	Not Included	194.60
	S162XRVP3BRBODY	Included	222.05

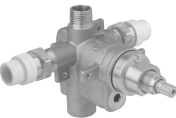
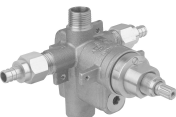

Temptrol® Shower Valves with Integral Volume Control

	DESCRIPTION	MODEL	EASYSERVICE™ STOPS	PRICE
 <ul style="list-style-type: none"> Temptrol Pressure-Balancing Shower Valve Body with VersaFlex Integral Volume Control Adjustable stop screw to limit handle turn Male 1/2" NPT or direct sweat inputs and shower port Female 1/2" NPT tub port Stringer mounts in casting Solid brass, bronze, and stainless steel construction 		<i>Standard</i>		
		S261BODY	Not Included	168.60
		S261XBODY	Included	196.20
		<i>Includes Reverse Seat for Back-to-Back Installation</i>		
		S261RVBODY	Not Included	168.60
		S261XRVBODY	Included	196.20
		<i>Includes ProSafe™ Test Cap in place of flow control spindle and cap nut</i>		
		S161BODY	Not Included	91.15
		S161XBODY	Included	118.60
		<i>Includes Tes Cap in place of flow control spindle and cap nut; Includes Reverse Seat for Back-to-Back Installation</i>		
		S161RVBODY	Not Included	91.15
		S161XRVBODY	Included	118.60
 <ul style="list-style-type: none"> Temptrol Pressure-Balancing Shower Valve Body with VersaFlex Integral Volume Control Adjustable stop screw to limit handle turn Male 1/2" NPT or direct sweat inputs and shower port Female 1/2" NPT tub port Stringer mounts in casting CPVC inlet fittings Solid brass, bronze, and stainless steel construction 		<i>Standard</i>		
		S261CPBODY	Not Included	188.55
		S261XCPBODY	Included	216.05
		<i>Includes Reverse Seat for Back-to-Back Installation</i>		
		S261RVCPBODY	Not Included	188.55
		S261XRVCPCBODY	Included	216.05
		<i>Includes ProSafe™ Test Cap in place of flow control spindle and cap nut</i>		
		S161CPBODY	Not Included	111.10
		S161XCPBODY	Included	138.65
		<i>Includes ProSafe™ Test Cap in place of flow control spindle and cap nut; Includes Reverse Seat for Back-to-Back Installation</i>		
		S161RVCPBODY	Not Included	111.10
		S161XRVCPCBODY	Included	138.65
 <ul style="list-style-type: none"> Temptrol Pressure-Balancing Shower Valve Body with VersaFlex Integral Volume Control Adjustable stop screw to limit handle turn Male 1/2" NPT or direct sweat inputs and shower port Female 1/2" NPT tub port Stringer mounts in casting PEX crimp inlet fittings Solid brass, bronze, and stainless steel construction 		<i>Standard</i>		
		S261P1BODY	Not Included	188.55
		S261XP1BODY	Included	216.05
		<i>Includes Reverse Seat for Back-to-Back Installation</i>		
		S261RVP1BODY	Not Included	188.55
		S261XRVP1BODY	Included	216.05
		<i>Includes ProSafe™ Test Cap in place of flow control spindle and cap nut</i>		
		S161P1BODY	Not Included	111.10
		S161XP1BODY	Included	138.65
		<i>Includes ProSafe™ Test Cap in place of flow control spindle and cap nut; Includes Reverse Seat for Back-to-Back Installation</i>		
		S161RVP1BODY	Not Included	111.10
		S161XRVP1BODY	Included	138.65

Temptrol® Shower Valves with Integral Volume Control

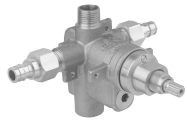



DESCRIPTION	MODEL	EASYSERVICE™ STOPS	PRICE
<ul style="list-style-type: none"> Temptrol Pressure-Balancing Shower Valve Body with VersaFlex Integral Volume Control Adjustable stop screw to limit handle turn Male 1/2" NPT or direct sweat inputs and shower port Female 1/2" NPT tub port Stringer mounts in casting PEX cold expansion inlet fittings Solid brass, bronze, and stainless steel construction 	<i>Standard</i>		
	S261P2BODY	Not Included	188.55
	S261XP2BODY	Included	216.05
	<i>Includes Reverse Seat for Back-to-Back Installation</i>		
	S261RVP2BODY	Not Included	188.55
	S261XRVP2BODY	Included	216.05
	<i>Includes ProSafe™ Test Cap in place of flow control spindle and cap nut</i>		
	S161P2BODY	Not Included	111.10
	S161XP2BODY	Included	138.65
	<i>Includes ProSafe™ Test Cap in place of flow control spindle and cap nut; Includes Reverse Seat for Back-to-Back Installation</i>		
	S161RVP2BODY	Not Included	111.10
	S161XRVP2BODY	Included	138.65



<ul style="list-style-type: none"> Temptrol Pressure-Balancing Shower Valve Body with VersaFlex Integral Volume Control Adjustable stop screw to limit handle turn Male 1/2" NPT or direct sweat inputs and shower port Female 1/2" NPT tub port Stringer mounts in casting ProPress® stub out inlet fittings Solid brass, bronze, and stainless steel construction 	<i>Standard</i>		
	S261P3BODY	Not Included	224.40
	S261XP3BODY	Included	251.85
	<i>Includes Reverse Seat for Back-to-Back Installation</i>		
	S261RVP3BODY	Not Included	224.40
	S261XRVP3BODY	Included	251.85
	<i>Includes ProSafe™ Test Cap in place of flow control spindle and cap nut</i>		
	S161P3BODY	Not Included	146.85
	S161XP3BODY	Included	174.35
	<i>Includes ProSafe™ Test Cap in place of flow control spindle and cap nut; Includes Reverse Seat for Back-to-Back Installation</i>		
	S161RVP3BODY	Not Included	146.85
	S161XRVP3BODY	Included	174.35



Temptrol Rapid Install™ Shower Valves with Integral Diverter

DESCRIPTION	MODEL	EASYSERVICE™ STOPS	PRICE
 <ul style="list-style-type: none"> Temptrol Rapid Install Pressure-Balancing Shower Valve Body with VersaFlex Integral Volume Control Adjustable stop screw to limit handle turn Male 1/2" NPT or direct sweat inputs and shower port Female 1/2" NPT tub port Stringer mounts in casting Nylon Rapid Install bracket with 4 straps included Solid brass, bronze, and stainless steel valve body construction 	<i>Standard</i>		
	S261BRBODY	Not Included	216.30
	S261XBRBODY	Included	243.90
	<i>Includes Reverse Seat for Back-to-Back Installation</i>		
	S261RVBRBODY	Not Included	216.30
	S261XRVRBODY	Included	243.90
	<i>Includes ProSafe™ Test Cap in place of flow control spindle and cap nut</i>		
	S161BRBODY	Not Included	138.90
	S161XBRBODY	Included	166.45
	<i>Includes ProSafe™ Test Cap in place of flow control spindle and cap nut; Includes Reverse Seat for Back-to-Back Installation</i>		
	S161RVBRBODY	Not Included	138.90
	S161XRVRBODY	Included	166.45
 <ul style="list-style-type: none"> Temptrol Rapid Install Pressure-Balancing Shower Valve Body with VersaFlex Integral Volume Control Adjustable stop screw to limit handle turn Male 1/2" NPT or direct sweat inputs and shower port Female 1/2" NPT tub port Stringer mounts in casting CPVC inlet fittings Nylon Rapid Install bracket with 4 straps included Solid brass, bronze, and stainless steel valve body construction 	<i>Standard</i>		
	S261CPBRBODY	Not Included	236.25
	S261XCPBRBODY	Included	263.80
	<i>Includes Reverse Seat for Back-to-Back Installation</i>		
	S261RVCPBRBODY	Not Included	236.25
	S261XRVCPRBODY	Included	263.80
	<i>Includes ProSafe™ Test Cap in place of flow control spindle and cap nut</i>		
	S161CPBRBODY	Not Included	158.80
	S161XCPBRBODY	Included	186.30
	<i>Includes ProSafe™ Test Cap in place of flow control spindle and cap nut; Includes Reverse Seat for Back-to-Back Installation</i>		
	S161RVCPBRBODY	Not Included	158.80
	S161XRVCPRBODY	Included	186.30
 <ul style="list-style-type: none"> Temptrol Rapid Install Pressure-Balancing Shower Valve Body with VersaFlex Integral Volume Control Adjustable stop screw to limit handle turn Male 1/2" NPT or direct sweat inputs and shower port Female 1/2" NPT tub port Stringer mounts in casting PEX crimp inlet fittings Nylon Rapid Install bracket with 4 straps included Solid brass, bronze, and stainless steel valve body construction 	<i>Standard</i>		
	S261P1BRBODY	Not Included	236.25
	S261XP1BRBODY	Included	263.80
	<i>Includes Reverse Seat for Back-to-Back Installation</i>		
	S261RVP1BRBODY	Not Included	236.25
	S261XRVP1BRBODY	Included	263.80
	<i>Includes ProSafe™ Test Cap in place of flow control spindle and cap nut</i>		
	S161P1BRBODY	Not Included	158.80
	S161XP1BRBODY	Included	186.30
	<i>Includes ProSafe™ Test Cap in place of flow control spindle and cap nut; Includes Reverse Seat for Back-to-Back Installation</i>		
	S161RVP1BRBODY	Not Included	158.80
	S161XRVP1BRBODY	Included	186.30

Temptrol Rapid Install™ Shower Valves with Integral Diverter

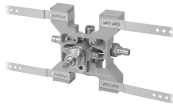
DESCRIPTION	MODEL	EASYSERVICE™ STOPS	PRICE
 <ul style="list-style-type: none"> Temptrol Rapid Install Pressure-Balancing Shower Valve Body with VersaFlex Integral Volume Control Adjustable stop screw to limit handle turn Male 1/2" NPT or direct sweat inputs and shower port Female 1/2" NPT tub port Stringer mounts in casting PEX cold expansion inlet fittings Nylon Rapid Install bracket with 4 straps included Solid brass, bronze, and stainless steel valve body construction 	<i>Standard</i>		
	S261P2BRBODY	Not Included	236.25
	S261XP2BRBODY	Included	263.80
	<i>Includes Reverse Seat for Back-to-Back Installation</i>		
	S261RVP2BRBODY	Not Included	236.25
	S261XRVP2BRBODY	Included	263.80
	<i>Includes ProSafe™ Test Cap in place of flow control spindle and cap nut</i>		
	S161P2BRBODY	Not Included	158.80
	S161XP2BRBODY	Included	186.30
	<i>Includes ProSafe™ Test Cap in place of flow control spindle and cap nut; Includes Reverse Seat for Back-to-Back Installation</i>		
	S161RVP2BRBODY	Not Included	158.80
	S161XRVP2BRBODY	Included	186.30



 <ul style="list-style-type: none"> Temptrol Rapid Install Pressure-Balancing Shower Valve Body with VersaFlex Integral Volume Control Adjustable stop screw to limit handle turn Male 1/2" NPT or direct sweat inputs and shower port Female 1/2" NPT tub port Stringer mounts in casting ProPress® stub out inlet fittings Nylon Rapid Install bracket with 4 straps included Solid brass, bronze, and stainless steel valve body construction 	<i>Standard</i>		
	S261P3BRBODY	Not Included	272.00
	S261XP3BRBODY	Included	299.55
	<i>Includes Reverse Seat for Back-to-Back Installation</i>		
	S261RVP3BRBODY	Not Included	272.00
	S261XRVP3BRBODY	Included	299.55
	<i>Includes ProSafe™ Test Cap in place of flow control spindle and cap nut</i>		
	S161P3BRBODY	Not Included	194.60
	S161XP3BRBODY	Included	222.05
	<i>Includes ProSafe™ Test Cap in place of flow control spindle and cap nut; Includes Reverse Seat for Back-to-Back Installation</i>		
	S161RVP3BRBODY	Not Included	194.60
	S161XRVP3BRBODY	Included	222.05





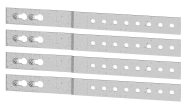

Modifications for Temptrol Shower and Tub/Shower Valves

SUFFIX	DESCRIPTION	PRICE
CHKS	Integral check stops - for use in installations where a positive shut-off device is used downstream of mixing valve	80.40

Temptrol Rapid Install™ Bracket

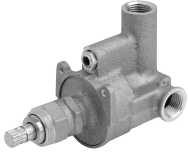
	DESCRIPTION	MODEL	PRICE
	<ul style="list-style-type: none">• Rapid Install Bracket• Heat-resistant nylon• For use with 26 and 16 Series Temptrol valves• Includes bracket and 4 straps• Reduces valve installation time by up to 67%	RTS-076	47.75
	<ul style="list-style-type: none">• Set of 4 replacement straps• Metal construction• For use with Rapid Install bracket	RTS-077	16.45

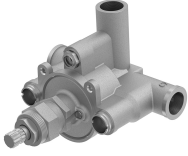



VisuTemp® Shower and Tub/Shower Valves

	DESCRIPTION	MODEL	SERVICE STOPS	PRICE
	<ul style="list-style-type: none"> • VisuTemp Pressure-Balancing Mixing Valve with Integral Thermometer • Adjustable stop screw to limit handle turn • Female IPS 	4-500VT-BODY	Not Included	439.00
				
	<ul style="list-style-type: none"> • VisuTemp Pressure-Balancing Mixing Valve with Integral Thermometer • Adjustable stop screw to limit handle turn • Female IPS • Built-in service stops 	4-500VT-X-BODY	Included	551.70
				

Modifications for VisuTemp Shower and Tub/Shower Valves

SUFFIX	DESCRIPTION	PRICE
X-3/4"	3/4" valve to increase flow approximately 20%	170.50
X-CHKS	Integral check stops - for use in installations where a positive shut-off device is used downstream of mixing valve	124.80









SafetyMix® Shower and Tub/Shower Valves

	DESCRIPTION	MODEL	SERVICE STOPS	PRICE
	<ul style="list-style-type: none"> • SafetyMix Heavy-Duty Pressure-Balancing Shower Valve • Adjustable stop screw to limit handle turn • Female IPS with sweat inlet/outlet connections 	4-500-BODY	Not Included	386.90
				
	<ul style="list-style-type: none"> • SafetyMix Heavy-Duty Pressure-Balancing Shower Valve • Adjustable stop screw to limit handle turn • Female IPS with sweat inlet/outlet connections • Built-in service stops 	4-500-X-BODY	Included	499.60
				

Modifications for SafetyMix Shower and Tub/Shower Valves

SUFFIX	DESCRIPTION	PRICE
X-CHKS	Integral check stops - for use in installations where a positive shut-off device is used downstream of mixing valve	150.80
X-REV	Reverse coring, hot on right, cold on left, for back to back installations with integral stops only	92.35

Symmons Shower and Tub/Shower Diverter Valves

	DESCRIPTION	MODEL	SERVICE STOPS	PRICE
	<ul style="list-style-type: none"> • Dual-Outlet Diverter Valve • Shared functionality between two outputs with defined detents • 2 distinct positions and 2 shared positions • Male IPS and sweat inlet/outlet connections • Common plane 	<i>For use with S-46 Series Temptrol® valves</i>		
		2DIV-BODY	NA	197.55
		<i>For use with 26 and 16 Series Temptrol® valves</i>		
		2DIVBODYSRT	NA	197.55
				
	<ul style="list-style-type: none"> • Dual-Outlet Diverter Valve • 2 distinct positions, no shared functionality • Defined detents • Male IPS and sweat inlet/outlet connections • Common plane 	<i>For use with S-46 Series Temptrol® valves</i>		
		2DIV-BODY-NS	NA	197.55
		<i>For use with 26 and 16 Series Temptrol® valves</i>		
		2DIVBODYNSRT	NA	197.55
				
	<ul style="list-style-type: none"> • Triple-Outlet Diverter Valve • Shared functionality in two positions with defined detents • 3 distinct positions and 3 shared positions • Male IPS and sweat inlet/outlet connections • Common plane 	<i>For use with S-46 Series Temptrol® valves</i>		
		3DIV-BODY	NA	246.80
		<i>For use with 26 and 16 Series Temptrol® valves</i>		
		3DIVBODYSRT	NA	246.80
				
	<ul style="list-style-type: none"> • Triple-Outlet Diverter Valve • 3 distinct positions, no shared functionality • Defined detents • Male IPS and sweat inlet/outlet connections • Common plane 	<i>For use with S-46 Series Temptrol® valves</i>		
		3DIV-BODY-NS	NA	246.80
		<i>For use with 26 and 16 Series Temptrol® valves</i>		
		3DIVBODYNSRT	NA	246.80
				

Temptrol® Commercial Tub/Shower







Temptrol Commercial tub/shower trims are constructed of high quality heavy duty metal components. Partnered with the dependability of the Symmons Temptrol valve, Commercial Temptrol can endure the day to day wear and tear found in applications such as education, healthcare and correctional facilities.

Available in:





Polished
Chrome

Temptrol® Commercial Shower and Tub/Shower

	DESCRIPTION	MODEL	FINISH	PRICE
	<ul style="list-style-type: none"> Temptrol Shower Trim Metal lever handle 2-1/4" single-function showerhead 2.0 gpm (7.6 L/min) flow rate Tub spout not included 	<i>Trim Only: 26 Series Temptrol® valve required (see page 139)</i>		
		C-96-1-TRM	Chrome	339.50
		<i>Trim Only with flow control spindle and cap nut: 16 Series Temptrol® valve required (see page 139)</i>		
	<ul style="list-style-type: none"> Temptrol Tub and Shower Trim Metal lever handle 5-1/2" diverter tub spout 2-1/4" single-function showerhead 2.0 gpm (7.6 L/min) flow rate 	<i>Trim Only: 26 Series Temptrol® valve required (see page 139)</i>		
		C-96-2-TRM	Chrome	380.05
		<i>Trim Only with flow control spindle and cap nut: 16 Series Temptrol® valve required (see page 139)</i>		
	<ul style="list-style-type: none"> Temptrol Hand Shower Trim Metal lever handle 30" slide bar for hand shower 60" flexible metal hose 3" single-function hand shower wand 2.0 gpm (7.6 L/min) flow rate Tub spout and showerhead not included 	<i>Trim Only: 26 Series Temptrol® valve required (see page 139)</i>		
		C-96-300-B30-V-TRM	Chrome	867.40
		<i>Trim Only with flow control spindle and cap nut: 16 Series Temptrol® valve required (see page 139)</i>		
	<ul style="list-style-type: none"> Temptrol Tub and Hand Shower Trim Metal lever handle 30" slide bar for hand shower 5-1/2" diverter tub spout 60" flexible metal hose 3" single-function hand shower wand 2.0 gpm (7.6 L/min) flow rate Showerhead not included 	<i>Trim Only: 26 Series Temptrol® valve required (see page 139)</i>		
		C-96-400-B30-V-TRM	Chrome	886.85
		<i>Trim Only with flow control spindle and cap nut: 16 Series Temptrol® valve required (see page 139)</i>		
	<ul style="list-style-type: none"> Temptrol Shower and Hand Shower Trim Metal lever handle 30" slide bar for hand shower Separate dual outlet diverter trim 60" flexible metal hose 3" single-function hand shower wand 2-1/4" single-function showerhead 2.0 gpm (7.6 L/min) flow rate Tub spout not included 	<i>Trim Only: 26 Series Temptrol® and 2DIV Series valves required (see pages 139 and 158)</i>		
		C-96-500-B30-V-TRM	Chrome	1202.80
		<i>Trim Only with flow control spindle and cap nut: 16 Series Temptrol® and 2DIV Series valves required (see pages 139 and 158)</i>		
		C96500B30VTRMTC	Chrome	1280.30

Temptrol® Commercial Shower and Tub/Shower

DESCRIPTION	MODEL	FINISH	PRICE
 <ul style="list-style-type: none"> • Temptrol Shower System Trim • Metal lever handle • 30" slide bar for hand shower • Separate triple outlet diverter trim • 5-1/4" non-diverter tub spout • 60" flexible metal hose • 3" single-function hand shower wand • 2-1/4" single-function showerhead • 2.0 gpm (7.6 L/min) flow rate 	<i>Trim Only: 26 Series Temptrol® and 3DIV Series valves required (see pages 139 and 158)</i>		
	C-96-600-B30-V-TRM	Chrome	1222.05
 <ul style="list-style-type: none"> • Temptrol Shower Valve Trim • Metal lever handle • Tub spout and showerhead not included 	<i>Trim Only: 26 Series Temptrol® valve required (see page 139)</i>		
	C-86-2-TRM	Chrome	218.40
	<i>Trim Only with flow control spindle and cap nut: 16 Series Temptrol® valve required (see page 139)</i>		
	C862TRMTC	Chrome	295.90



Modifications for all Temptrol Commercial Valves and Systems

SUFFIX	DESCRIPTION	PRICE
Delete Suffix B30	2 wall hooks in place of 30" bar	-101.85
L1	Less showerhead	-52.05
L2	Less hand shower	-23.80
L3	Less showerhead and hand shower	-75.80
L4	Less showerhead, arm and flange	-65.15
L5	Less hand shower system	-229.55
L6	Less tub spout (for non diverter tub spout, deduct this line)	-13.80
L6.	Less tub spout (for diverter tub spout, deduct this line)	-30.95
L7	Less handle	-37.70

SafetyMix® Tub/Shower

SafetyMix®

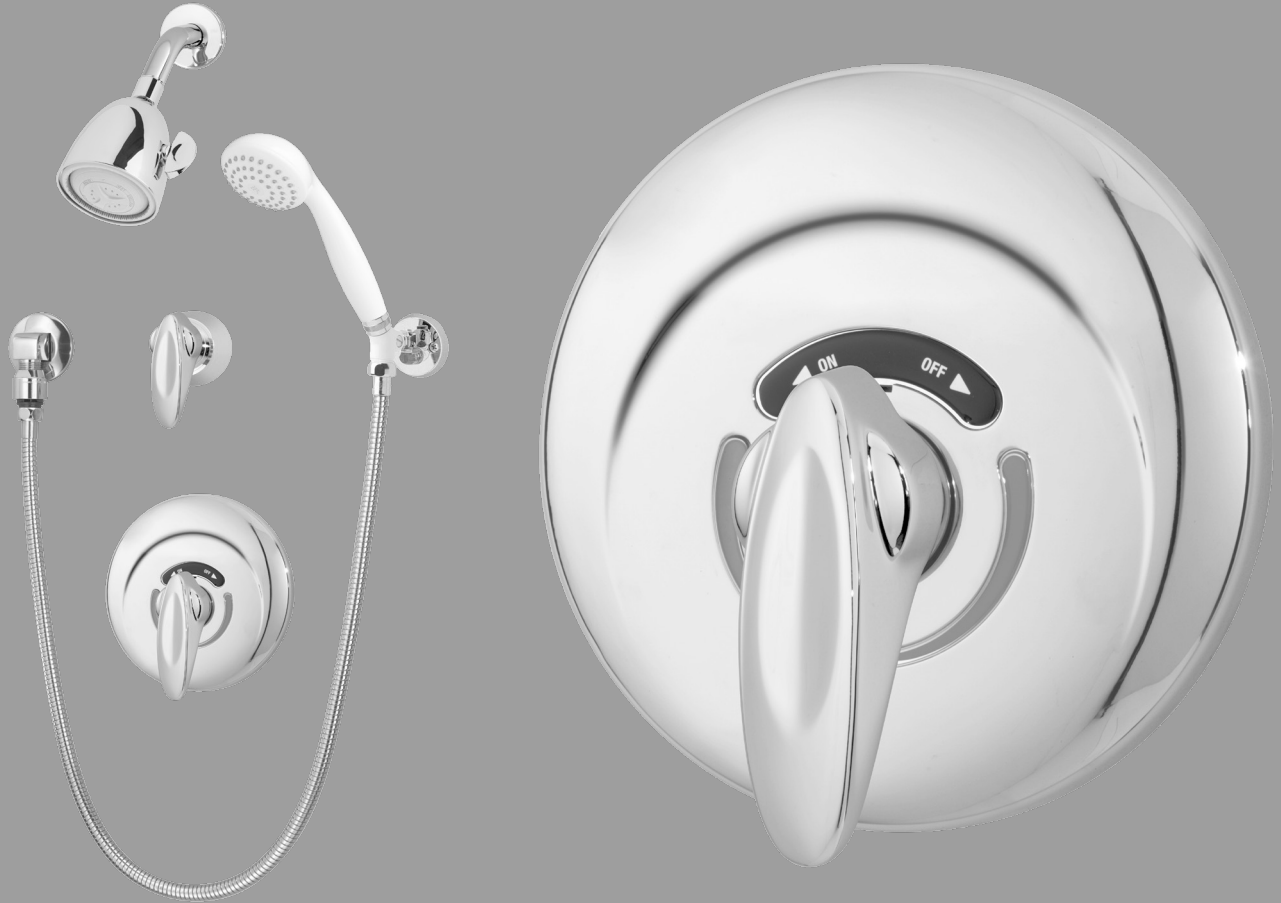

The original Symmons pressure balancing valve, SafetyMix is designed to last the life of the building. Quality, durability and safety all come standard with every SafetyMix tub/shower valve and trim. SafetyMix tub/shower systems are ideal for high use commercial and institutional applications where safety and quality cannot be compromised.





Available in:





Polished
Chrome

Tub/Shower Systems

SafetyMix® Shower and Tub/Shower

	DESCRIPTION	MODEL	FINISH	PRICE
	<ul style="list-style-type: none"> SafetyMix Shower SafetyMix Pressure Balancing valve Metal lever handle Adjustable stop screw to limit handle turn 3-1/4" showerhead with 2 modes Red and blue indicators on escutcheon 2.0 gpm (7.6 L/min) flow rate Tub spout not included 	<i>Valve & Trim: 4-500-BODY included (see page 157)</i> 1-100	Chrome	1162.55
		<i>Trim Only: 4-500-BODY or 4-500-X-BODY required (see page 157)</i> 1-100-TRM	Chrome	770.95
	<ul style="list-style-type: none"> SafetyMix Tub and Shower SafetyMix Pressure Balancing valve Metal lever handle Adjustable stop screw to limit handle turn Separate dual outlet push-button diverter 5-1/4" non-diverter tub spout 3-1/4" showerhead with 2 modes Red and blue indicators on escutcheon 2.0 gpm (7.6 L/min) flow rate 	<i>Valve & Trim: 4-500-BODY included (see page 157)</i> 1-210	Chrome	1508.85
		<i>Trim Only: 4-500-BODY or 4-500-X-BODY required (see page 157) and 4-451-BODY</i> 1-210-TRM	Chrome	1123.65
	<ul style="list-style-type: none"> SafetyMix Tub and Shower with Integral Stops SafetyMix Pressure Balancing valve Metal lever handle Adjustable stop screw to limit handle turn 5-1/2" diverter tub spout 3-1/4" showerhead with 2 modes Red and blue indicators on escutcheon 2.0 gpm (7.6 L/min) flow rate 	<i>Valve & Trim: 4-500-X-BODY included (see page 157)</i> 1-215-X	Chrome	1482.05
		<i>Trim Only: 4-500-BODY or 4-500-X-BODY required (see page 157)</i> 1-215-TRM	Chrome	976.15
	<ul style="list-style-type: none"> SafetyMix Hand Shower SafetyMix Pressure Balancing valve Metal lever handle Adjustable stop screw to limit handle turn 30" slide bar for hand shower 60" flexible metal hose 3" single-function hand shower wand Red and blue indicators on escutcheon 2.0 gpm (7.6 L/min) flow rate Tub spout and showerhead not included 	<i>Valve & Trim: 4-500-BODY included (see page 157)</i> 1-25-FSB	Chrome	1401.90
		<i>Trim Only: 4-500-BODY or 4-500-X-BODY required (see page 157)</i> 1-25-FSB-TRM	Chrome	1014.75

SafetyMix® Shower and Tub/Shower

DESCRIPTION	MODEL	FINISH	PRICE
 <ul style="list-style-type: none"> • SafetyMix Tub and Hand Shower Valve and Trim • SafetyMix Pressure Balancing valve • Metal lever handle • Adjustable stop screw to limit handle turn • 30" slide bar for hand shower • Separate dual outlet diverter • 5-1/4" non-diverter tub spout • 60" flexible metal hose • 3" single-function hand shower wand • Red and blue indicators on escutcheon • 2.0 gpm (7.6 L/min) flow rate • Showerhead not included 	<i>Valve & Trim: 4-500-BODY and 2DIV-BODY included (see pages 157 and 158)</i>		
	1-50-FSB	Chrome	1728.95
 <ul style="list-style-type: none"> • SafetyMix Shower and Hand Shower • SafetyMix Pressure Balancing valve • Metal lever handle • Adjustable stop screw to limit handle turn • Cradle for hand shower • Separate dual outlet diverter • 60" flexible metal hose • 3" single-function hand shower wand • 3-1/4" showerhead with 2 modes • Red and blue indicators on escutcheon • 2.0 gpm (7.6 L/min) flow rate • Tub spout not included 	<i>Valve & Trim: 4-500-BODY and 2DIV-BODY included (see page 157 and 158)</i>		
	1-117-FS	Chrome	1827.45
	<i>Trim Only: 4-500-BODY or 4-500-X-BODY and 2DIV-BODY required (see page 157 and 158)</i>		
	1-117-FS-TRM	Chrome	1237.15
 <ul style="list-style-type: none"> • SafetyMix Shower System Valve and Trim • SafetyMix Pressure Balancing valve • Metal lever handle • Adjustable stop screw to limit handle turn • Cradle for hand shower • Separate triple outlet diverter • 5-1/4" non-diverter tub spout • 60" flexible metal hose • 3" single-function hand shower wand • 3-1/4" showerhead with 2 modes • Red and blue indicators on escutcheon • 2.0 gpm (7.6 L/min) flow rate 	<i>Valve & Trim: 4-500-BODY and 3DIV-BODY included (see page 157 and 158)</i>		
	1-217-FS	Chrome	1938.75

SafetyMix® Shower and Tub/Shower



DESCRIPTION

- SafetyMix Valve and Trim
- SafetyMix Pressure Balancing valve
- Metal lever handle
- Adjustable stop screw to limit handle turn
- Red and blue indicators on escutcheon
- Diverter tub spout and showerhead not included



MODEL

Valve & Trim: 4-500-BODY included (see page 157)

4-500

FINISH

Chrome

PRICE

831.00



Trim Only: 4-500-BODY or 4-500-X-BODY required (see page 157)

4-500-TRM







Chrome

433.35

Modifications for all SafetyMix Shower and Tub/Shower Systems

SUFFIX	DESCRIPTION	PRICE
1.5	 1.5 gpm (5.7 L/min) flow restrictor	N/C
L1	Less showerhead	-65.35
L2	Less hand shower	-23.00
L3	Less showerhead and hand shower	-88.80
L4	Less showerhead, arm and flange	-99.60
L5	Less hand shower system (FSB)	-256.65
L5.	Less hand shower system (FS)	-180.15
L6	Less tub spout (for non diverter tub spout, deduct this line)	-13.30
L6.	Less tub spout (for diverter tub spout, deduct this line)	-29.85
NS	 Non-shared diverter valve for 1-117-FS, 1-217-FS and 1-50-FSB series	N/C
X	Integral service stops - allows water shut off at valve for service. Recommended for use on all multiple commercial installations	92.35
X-CHKS	Integral check stops - for use in installations where a positive shut-off device is used downstream of mixing valve	150.80

SafetyMix® Exposed Shower Systems

	DESCRIPTION	MODEL	FINISH	PRICE
	<ul style="list-style-type: none"> • SafetyMix Heavy Duty Exposed Shower System • Exposed SafetyMix pressure-balancing valve • Metal lever handle • 20" head riser • 32" supply risers • Single-function showerhead • 2.0 gpm (7.6 L/min) flow rate 	1-400	Chrome	2367.55
				
	<ul style="list-style-type: none"> • SafetyMix Heavy Duty Exposed Shower System • Exposed SafetyMix pressure-balancing valve • Metal lever handle • 20" head riser • #40 street ells with escutcheons • Single-function showerhead • 2.0 gpm (7.6 L/min) flow rate 	1-410	Chrome	2016.30
				
	<ul style="list-style-type: none"> • SafetyMix Heavy Duty Exposed Shower System • Exposed SafetyMix pressure-balancing valve • Metal lever handle • 20" head riser • #40 street ells with escutcheons • Heavy duty wall flange • Single-function showerhead • 2.0 gpm (7.6 L/min) flow rate 	1-510	Chrome	2326.35
				

Modifications for all SafetyMix Exposed Shower Systems

SUFFIX	DESCRIPTION	PRICE
A	Anchor plate for valve and head (1-510 only)	109.85
E	External volume control on showerhead (1-400 and 1-410)	60.50
X	Integral service stops - allows water shutoff at valve for service. Recommended for use on all multiple commercial installations	55.95

SafetyMix® Exposed Shower Valve



DESCRIPTION	MODEL	FINISH	PRICE
<ul style="list-style-type: none"> • SafetyMix Exposed Shower Valve • Exposed SafetyMix pressure-balancing valve • Metal lever handle • Adjustable stop screw to limit handle turn • Tub spout and showerhead not included 	4-521	Chrome	1261.50



Modifications for SafetyMix® Exposed Shower Valve

SUFFIX	DESCRIPTION	PRICE
CX	Integral check stops	91.40
W	Heavy duty wall flange	83.30
WA	Heavy duty wall flange with anchor plate	132.00
X	Integral service stops	36.45

VisuTemp®

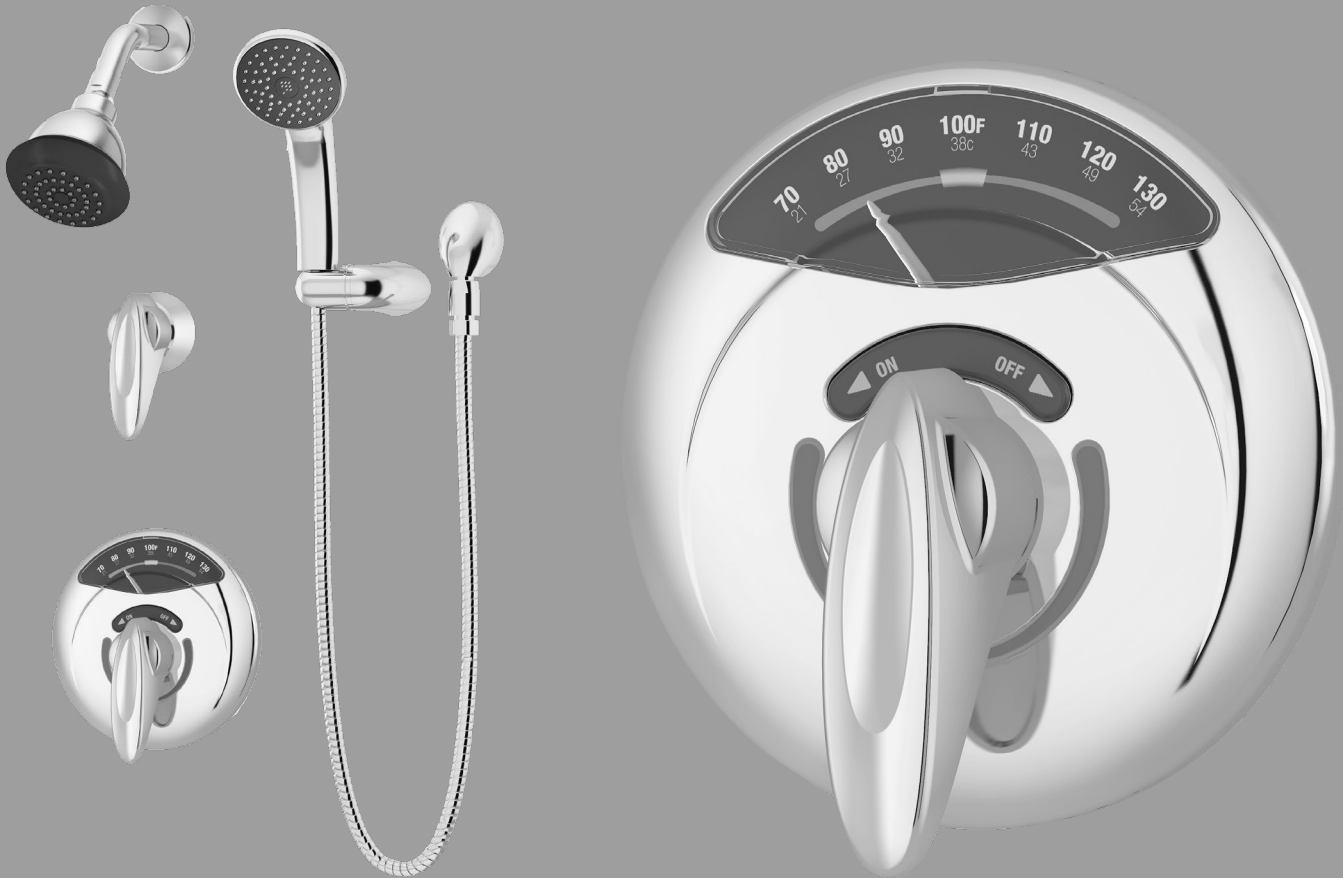

VisuTemp®

VisuTemp ClearVue™ is an ideal choice for specialized care applications. The easy to read display and built-in thermometer allows you to precisely set output temperature using a single handle. SafetyMix® pressure-balancing valve behind the wall shuts down water flow in the event of failure in hot or cold water.



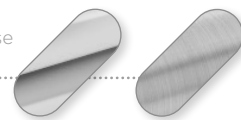





Available in these finishes:



Polished Chrome Satin Nickel
Radiance® PVD (STN)

Tub/Shower Systems

VisuTemp® Shower and Tub/Shower

	DESCRIPTION	MODEL	FINISH	PRICE	
	<ul style="list-style-type: none"> • VisuTemp Shower • VisuTemp pressure-balancing valve • Metal lever handle • Adjustable stop screw to limit handle turn • 3-1/2" single-function showerhead • Red and blue indicators with thermometer display on escutcheon • 2.0 gpm (7.6 L/min) flow rate • Tub spout not included 	<i>Valve & Trim: 4-500VT-BODY included (see page 156)</i>			
		1-1000VT	Chrome	1294.90	
		1-1000VT-STN	Satin Nickel	1607.30	
		<i>Trim Only: 4-500VT-BODY or 4-500VT-X-BODY required (see page 156)</i>			
		1-1000VT-TRM	Chrome	850.00	
		1-1000VT-STN-TRM	Satin Nickel	1168.20	
					
	<ul style="list-style-type: none"> • VisuTemp Shower • VisuTemp pressure-balancing valve • Metal lever handle • Adjustable stop screw to limit handle turn • 3-1/4" showerhead with 2 modes • Red and blue indicators with thermometer display on escutcheon • 2.0 gpm (7.6 L/min) flow rate • Tub spout not included 	<i>Valve & Trim: 4-500VT-BODY included (see page 156)</i>			
		1-100VT	Chrome	1082.90	
		<i>Trim Only: 4-500VT-BODY or 4-500VT-X-BODY required (see page 156)</i>			
		1-100VT-TRM	Chrome	634.25	
					
		<ul style="list-style-type: none"> • VisuTemp Tub and Shower • VisuTemp pressure-balancing valve • Metal lever handle • Adjustable stop screw to limit handle turn • Separate dual outlet diverter • 5-1/4" non-diverter tub spout • 3-1/2" single-function showerhead • Red and blue indicators with thermometer display on escutcheon • 2.0 gpm (7.6 L/min) flow rate 	<i>Valve & Trim: 4-500VT-BODY and 2DIV-BODY included (see pages 156 and 158)</i>		
		1-2100VT	Chrome	1588.25	
		1-2100VT-STN	Satin Nickel	2064.75	
		<i>Trim Only: 4-500VT-BODY or 4-500VT-X-BODY and 2DIV-BODY required (see pages 156 and 158)</i>			
		1-2100VT-TRM	Chrome	1148.80	
		1-2100VT-STN-TRM	Satin Nickel	1601.95	
					
	<ul style="list-style-type: none"> • VisuTemp Tub and Shower Valve and Trim • VisuTemp pressure-balancing valve • Metal lever handle • Adjustable stop screw to limit handle turn • Separate dual outlet push-button diverter • 5-1/4" non-diverter tub spout • 3-1/4" showerhead with 2 modes • Red and blue indicators with thermometer display on escutcheon • 2.0 gpm (7.6 L/min) flow rate 	<i>Valve & Trim: 4-500VT-BODY included (see page 156)</i>			
		1-210VT	Chrome	1384.10	
					

VisuTemp® Shower and Tub/Shower

VisuTemp®



DESCRIPTION	MODEL	FINISH	PRICE
<ul style="list-style-type: none"> • VisuTemp Hand Shower • VisuTemp pressure-balancing valve • Metal lever handle • Adjustable stop screw to limit handle turn • Cradle for hand shower • 60" flexible metal hose • 3-3/4" single-function hand shower wand • Red and blue indicators with thermometer display on escutcheon • 2.0 gpm (7.6 L/min) flow rate • Tub spout and showerhead not included 	<i>Valve & Trim: 4-500VT-BODY included (see page 156)</i>		
	1-250VT-H401-V	Chrome	1285.25
	<i>Trim Only: 4-500VT-BODY or 4-500VT-X-BODY required (see page 156)</i>		
	1-250VT-H401-V-TRM	Chrome	840.15







<ul style="list-style-type: none"> • VisuTemp Hand Shower • VisuTemp pressure-balancing valve • Metal lever handle • Adjustable stop screw to limit handle turn • Cradle for hand shower • 60" flexible metal hose • 3" white single-function hand shower wand • 2.0 gpm (7.6 L/min) flow rate • Tub spout and showerhead not included 	<i>Valve & Trim: 4-500VT-BODY included (see page 156)</i>		
	1-25VT-FS	Chrome	1063.20
	<i>Trim Only: 4-500VT-BODY or 4-500VT-X-BODY required (see page 156)</i>		
	1-25VT-FS-TRM	Chrome	614.10





<ul style="list-style-type: none"> • VisuTemp Shower and Hand Shower • VisuTemp pressure-balancing valve • Metal lever handle • Adjustable stop screw to limit handle turn • Cradle for hand shower • Separate dual outlet diverter • 60" flexible metal hose • 3-3/4" single-function hand shower wand • 4" single-function showerhead • Red and blue indicators with thermometer display on escutcheon • 2.0 gpm (7.6 L/min) flow rate • Tub spout not included 	<i>Valve & Trim: 4-500VT-BODY and 2DIV-BODY included (see pages 156 and 158)</i>		
	1-1170VT-H401-V	Chrome	1894.35
	<i>Trim Only: 4-500VT-BODY or 4-500VT-X-BODY and 2DIV-BODY required (see pages 156 and 158)</i>		
	1-1170VT-H401-V-TRM	Chrome	1249.85



VisuTemp® Shower and Tub/Shower

DESCRIPTION	MODEL	FINISH	PRICE
<ul style="list-style-type: none"> • VisuTemp Shower and Hand Shower • VisuTemp pressure-balancing valve • Metal lever handle • Adjustable stop screw to limit handle turn • Cradle for hand shower • Separate dual outlet diverter • 60" flexible metal hose • 3" white single-function hand shower wand • 3-1/4" showerhead with 2 modes • Red and blue indicators with thermometer display on escutcheon • 2.0 gpm (7.6 L/min) flow rate • Tub spout not included 	<i>Valve & Trim: 4-500VT-BODY and 2DIV-BODY included (see pages 156 and 158)</i>		
	1-117VT-FS	Chrome	1652.80
<ul style="list-style-type: none"> • VisuTemp Tub and Hand Shower • VisuTemp pressure-balancing valve • Metal lever handle • Adjustable stop screw to limit handle turn • Cradle for hand shower • Separate dual outlet diverter • 5-1/4" non-diverter tub spout • 60" flexible metal hose • 3-3/4" single-function hand shower wand • Red and blue indicators with thermometer display on escutcheon • 2.0 gpm (7.6 L/min) flow rate • Showerhead not included 	<i>Valve & Trim: 4-500VT-BODY and 2DIV-BODY included (see page 156 and 158)</i>		
	1-500VT-H401-V	Chrome	1589.20
<ul style="list-style-type: none"> • VisuTemp Tub and Hand Shower • VisuTemp pressure-balancing valve • Metal lever handle • Adjustable stop screw to limit handle turn • Cradle for hand shower • Separate dual outlet diverter • 5-1/4" non-diverter tub spout • 60" flexible metal hose • 3" white single-function hand shower wand • Red and blue indicators with thermometer display on escutcheon • 2.0 gpm (7.6 L/min) flow rate • Showerhead not included 	<i>Trim Only: 4-500VT-BODY or 4-500VT-X-BODY and 2DIV-BODY required (see pages 156 and 158)</i>		
	1-500VT-H401-V-TRM	Chrome	939.00
<ul style="list-style-type: none"> • VisuTemp Tub and Hand Shower • VisuTemp pressure-balancing valve • Metal lever handle • Adjustable stop screw to limit handle turn • Cradle for hand shower • Separate dual outlet diverter • 5-1/4" non-diverter tub spout • 60" flexible metal hose • 3" white single-function hand shower wand • Red and blue indicators with thermometer display on escutcheon • 2.0 gpm (7.6 L/min) flow rate • Showerhead not included 	<i>Valve & Trim: 4-500VT-BODY and 2DIV-BODY included (see pages 156 and 158)</i>		
	1-50VT-FS	Chrome	1383.85
<ul style="list-style-type: none"> • VisuTemp Tub and Hand Shower • VisuTemp pressure-balancing valve • Metal lever handle • Adjustable stop screw to limit handle turn • Cradle for hand shower • Separate dual outlet diverter • 5-1/4" non-diverter tub spout • 60" flexible metal hose • 3" white single-function hand shower wand • Red and blue indicators with thermometer display on escutcheon • 2.0 gpm (7.6 L/min) flow rate • Showerhead not included 	<i>Trim Only: 4-500VT-BODY or 4-500VT-X-BODY and 2DIV-BODY required (see page 156 and 158)</i>		
	1-50VT-FS-TRM	Chrome	729.90

VisuTemp® Shower and Tub/Shower

DESCRIPTION	MODEL	FINISH	PRICE
<ul style="list-style-type: none"> • VisuTemp Shower System • VisuTemp pressure-balancing valve • Metal lever handle • Adjustable stop screw to limit handle turn • Cradle for hand shower • Separate triple outlet diverter • 5-1/4" non-diverter tub spout • 60" flexible metal hose • 3-3/4" single-function hand shower wand • 4" single-function showerhead • Red and blue indicators with thermometer display on escutcheon • 2.0 gpm (7.6 L/min) flow rate 	<i>Valve & Trim: 4-500VT-BODY and 3DIV-BODY included (see pages 156 and 158)</i>		
	1-3170VT-H401-V	Chrome	1906.05
<ul style="list-style-type: none"> • VisuTemp Shower System • VisuTemp pressure-balancing valve • Metal lever handle • Adjustable stop screw to limit handle turn • Cradle for hand shower • Separate triple outlet diverter • 5-1/4" non-diverter tub spout • 60" flexible metal hose • 3" white single-function hand shower wand • 3-1/4" showerhead with 2 modes • Red and blue indicators with thermometer display on escutcheon • 2.0 gpm (7.6 L/min) flow rate 	<i>Valve & Trim: 4-500VT-BODY and 3DIV-BODY included (see pages 156 and 158)</i>		
	1-317VT-FS	Chrome	1748.25
<ul style="list-style-type: none"> • VisuTemp Valve and Trim • VisuTemp pressure-balancing valve • Metal lever handle • Adjustable stop screw to limit handle turn • Red and blue indicators with thermometer display on escutcheon • Showerhead not included 	<i>Valve & Trim: 4-500VT-BODY included (see page 156)</i>		
	4-5000VT	Chrome	796.75
	4-5000VT-STN	Satin Nickel	1369.20
	<i>Trim Only: 4-500VT-BODY or 4-500VT-X-BODY required (see page 156)</i>		
4-5000VT-TRM	Chrome	342.80	
4-5000VT-STN-TRM	Satin Nickel	925.80	



Modifications for all VisuTemp Shower and Tub/Shower Systems

SUFFIX	DESCRIPTION	CHROME	STN
1.5	 1.5 gpm (5.7 L/min) flow restrictor	N/C	N/A
X	Integral service stops - allows water shutoff at valve for service. Recommended for use on all multiple or commercial installations	92.35	92.35
X-3/4"	3/4" valve to increase flow approximately 20%	170.50	170.50
X-CHKS	Integral check stops - for use in installations where a positive shut-off device is used downstream of mixing valve	124.80	124.80

LigRes® Shower Trim



LigRes®

The LigRes shower and diverter trim was developed to meet behavioral health professional needs for minimizing ligature points and enhance patient safety. The LigRes shower and diverter trims utilize the Temptrol® valve to provide consistent and reliable performance for behavioral health shower applications.

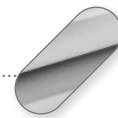

Available in:



Polished
Chrome

Shower and Diverter Valve Trim

LigRes® Ligature-Resistant Shower and Diverter Valve Trim







	DESCRIPTION	MODEL	FINISH	PRICE
	<ul style="list-style-type: none"> LigRes Shower Valve Trim Fits any Temptrol shower valve Ligature-resistant handle and escutcheon Tub spout and showerhead not included 	<i>Trim Only: 26 Series Temptrol® valve required (see page 139)</i> 5700-TRM	Chrome	748.15
		<ul style="list-style-type: none"> LigRes Shower Valve Trim Kit Fits any Temptrol shower valve Ligature-resistant handle and escutcheon TA-10 flow control spindle included TA-4 hot/cold valve seats included Tub spout and showerhead not included 	5700-REB-TRM	Chrome
	<ul style="list-style-type: none"> LigRes Diverter Valve Trim Ligature-resistant handle and escutcheon 	<i>Trim Only: 2DIV Series valve required (see page 158)</i> 57-2DIV-TRM	Chrome	625.10

HydaPipe® Shower







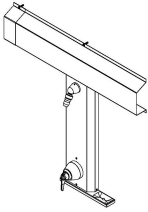

The reliability of Symmons pressure-balancing valves combined with the durability of 18 gauge stainless steel, make Symmons HydaPipe the trusted choice for educational, institutional and industrial installations. Order standard HydaPipe configurations from our catalog or custom build your unit to meet the needs of any construction project.

HydaPipe® 900 Series Shower

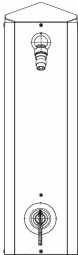
	DESCRIPTION	MODEL	FINISH	PRICE
	<ul style="list-style-type: none"> HydaPipe Surface-Mounted Shower System Temptrol pressure-balancing valve Adjustable stop screw to limit handle turn Built-in screwdriver supply stops Left or right mounted soap dish included Single-function showerhead 2.0 gpm (7.6 L/min) flow rate 	H901S	Chrome	1699.35
				
	<ul style="list-style-type: none"> HydaPipe Surface-Mounted Shower System Temptrol pressure-balancing valve Adjustable stop screw to limit handle turn Built-in screwdriver supply stops ADA 36" slide/grab bar for hand shower 60" flexible metal hose 3-3/8" ADA single-function hand shower wand with non-positive shutoff Dual outlet built-in diverter Left or right mounted soap dish included Single-function showerhead 2.0 gpm (7.6 L/min) flow rate 	H902S	Chrome	3275.05
				
	<ul style="list-style-type: none"> HydaPipe Surface-Mounted Shower System with Supply Covers Temptrol pressure-balancing valve Adjustable stop screw to limit handle turn Built-in screwdriver supply stops Custom length extension cover cut to order Left or right mounted soap dish included Single-function showerhead 2.0 gpm (7.6 L/min) flow rate 	H903S	Chrome	POA
				









HydaPipe® 900 Series Shower

	DESCRIPTION	MODEL	FINISH	PRICE
	<ul style="list-style-type: none"> HydaPipe Surface-Mounted Shower System with Horizontal Supply Covers Temptrol pressure-balancing valve Adjustable stop screw to limit handle turn Built-in screwdriver supply stops Custom length horizontal extension cover cut to order Left or right mounted soap dish included Single-function showerhead 2.0 gpm (7.6 L/min) flow rate 	H905S	Chrome	POA
				
	<ul style="list-style-type: none"> HydaPipe Surface-Mounted Corner Shower System Temptrol pressure-balancing valve Adjustable stop screw to limit handle turn Built-in screwdriver supply stops Single-function showerhead 2.0 gpm (7.6 L/min) flow rate 	H907	Chrome	2070.40
				
	<ul style="list-style-type: none"> HydaPipe Flat Wall Shower System Temptrol pressure-balancing valve Adjustable stop screw to limit handle turn Built-in screwdriver supply stops Built-in soap dish Single-function showerhead 2.0 gpm (7.6 L/min) flow rate 	H911RS	Chrome	2768.00
				

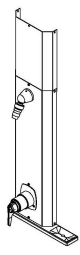
Modifications for HydaPipe 900 Series Exposed Shower and Tub/Shower Systems

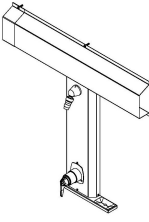
SUFFIX	DESCRIPTION	PRICE
21	HydaPipe shower unit with single control on-off valve	63.15
22	Single supply, manual shutoff, lever handle	128.85
56	HydaPipe shower unit with combination SafetyMix and ShowerOff valve	930.90
60	HydaPipe shower unit with ShowerOff valve	87.75
L1	Less showerhead	-64.25
L2	Less hand shower	-46.60
L3	Less showerhead and hand shower	-110.85
L5	Less hand shower system	-207.55
L6	Less tub spout	-29.50
L7	Less handle	-38.70
CWM	Wall-mounted cake soap dish	163.95
Delete Suffix S	Less soap dish	-42.75
WD	Winter drain	N/C

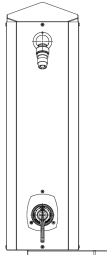
HydaPipe® 800 Series Shower

	DESCRIPTION	MODEL	FINISH	PRICE
	<ul style="list-style-type: none"> HydaPipe Surface-Mounted Shower System SafetyMix pressure-balancing valve Adjustable stop screw to limit handle turn Built-in screwdriver supply stops Left or right mounted soap dish included Single-function showerhead 2.0 gpm (7.6 L/min) flow rate 	H801S	Chrome	2171.65
				
	<ul style="list-style-type: none"> HydaPipe Surface-Mounted Shower System with Supply Covers SafetyMix pressure-balancing valve Adjustable stop screw to limit handle turn Built-in screwdriver supply stops Custom length extension cover cut to order Left or right mounted soap dish included Single-function showerhead 2.0 gpm (7.6 L/min) flow rate 	H803S	Chrome	POA
				
	<ul style="list-style-type: none"> HydaPipe Surface-Mounted Shower System with Horizontal Supply Covers SafetyMix pressure-balancing valve Adjustable stop screw to limit handle turn Built-in screwdriver supply stops Custom length horizontal extension cover cut to order Left or right mounted soap dish included Single-function showerhead 2.0 gpm (7.6 L/min) flow rate 	H805S	Chrome	POA
				
	<ul style="list-style-type: none"> HydaPipe Surface-Mounted Corner Shower System SafetyMix pressure-balancing valve Adjustable stop screw to limit handle turn Built-in screwdriver supply stops Soap dish included Single-function showerhead 2.0 gpm (7.6 L/min) flow rate 	H807S	Chrome	2659.95
				

Modifications for all HydaPipe 800 Series Systems

SUFFIX	DESCRIPTION	PRICE
21	HydaPipe shower unit with single control on-off valve	87.75
56	HydaPipe shower unit with combination SafetyMix and ShowerOff valve	930.90
60	HydaPipe shower unit with ShowerOff valve	87.75
REV	Reverse coring, hot on right, cold on left, for back-to-back installations	N/C
RS	Recessed soap dish in place of standard soap dish	345.20
L1	Less showerhead	-64.25
L2	Less hand shower	-46.60
L3	Less showerhead and hand shower	-110.85
L5	Less hand shower system	-207.55
L7	Less handle	-38.70
Delete Suffix S	Less soap dish	-46.60
WD	Winter drain	N/C

ShowerOff® Metering Shower

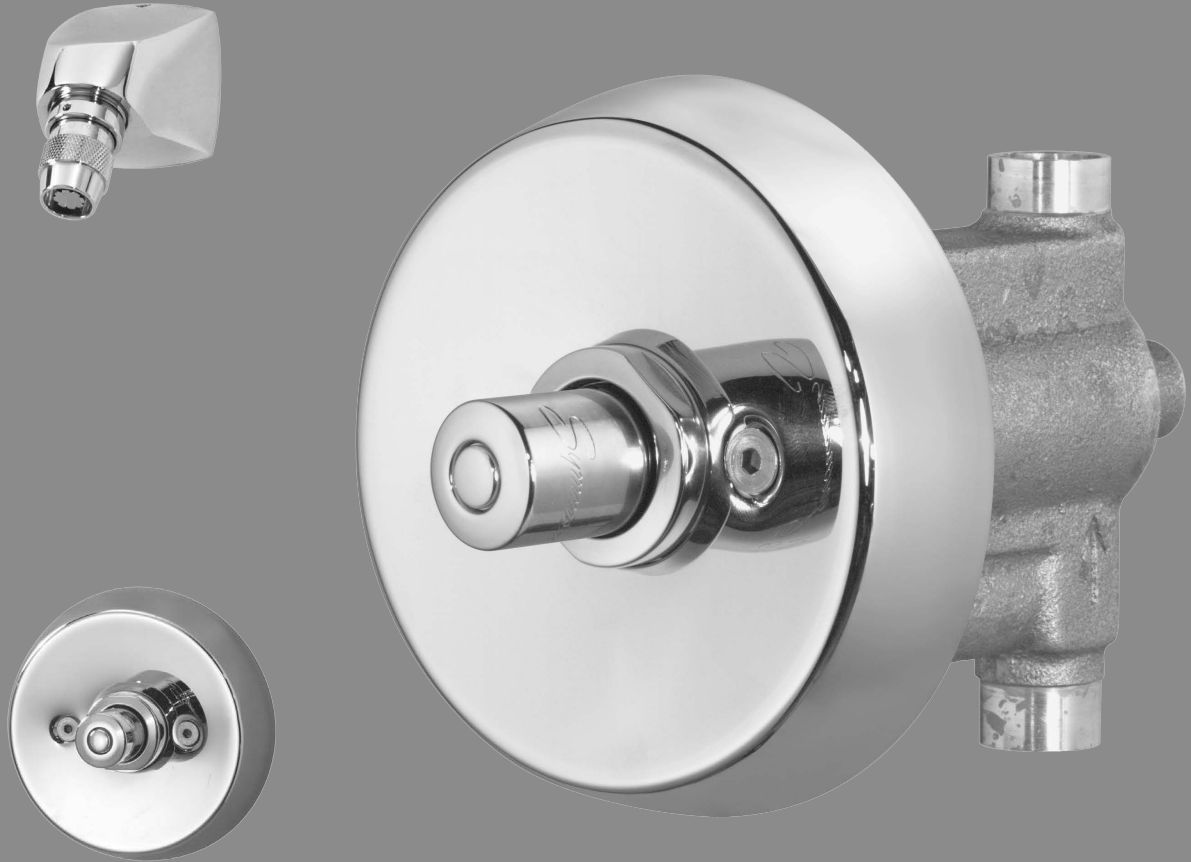





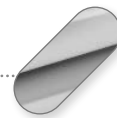







ShowerOff is a durable, piston-actuated metering shower valve that provides a full shower flow for approximately 45 seconds to minimize water consumption and reduce energy costs. This solution is ideal for public showers, correctional facilities or applications where positive control of shower water usage is wanted.

Available in:













Polished
Chrome

ShowerOff® Metering Shower Systems

	DESCRIPTION	MODEL	FINISH	PRICE
	<ul style="list-style-type: none"> • ShowerOff Metering Shower System • 4-427 valve • Integral service stop • Adjustable run time • 4-295-B single-function institutional showerhead 	3-310	Chrome	1150.40
	<ul style="list-style-type: none"> • Vandal resistant • 2.0 gpm (7.6 L/min) flow rate 			
				
	<ul style="list-style-type: none"> • ShowerOff Metering Shower System • 4-427R valve • Integral service stop • Adjustable run time • Rear mounting escutcheon • 4-295-B single-function institutional showerhead 	3-310-R	Chrome	1196.70
	<ul style="list-style-type: none"> • Vandal resistant • 2.0 gpm (7.6 L/min) flow rate 			
				
	<ul style="list-style-type: none"> • ShowerOff Metering Shower System • 4-428 valve • Integral service stop • Adjustable run time • 4-295 single-function institutional showerhead 	3-320	Chrome	1114.65
	<ul style="list-style-type: none"> • Vandal resistant • 2.0 gpm (7.6 L/min) flow rate 			
				
	<ul style="list-style-type: none"> • ShowerOff Metering Shower System • 4-428-R valve • Integral service stop • Adjustable run time • Rear mounting escutcheon • 4-295 single-function institutional showerhead 	3-320-R	Chrome	1196.70
	<ul style="list-style-type: none"> • Vandal resistant • 2.0 gpm (7.6 L/min) flow rate 			
				

ShowerOff® Metering Shower Systems

	DESCRIPTION	MODEL	FINISH	PRICE
	<ul style="list-style-type: none"> • ShowerOff Metering Shower System • 4-420 valve • Integral service stop • Adjustable run time • 4-295 single-function institutional showerhead • Vandal resistant • 2.0 gpm (7.6 L/min) flow rate 	3-325	Chrome	1018.95
				
	<ul style="list-style-type: none"> • ShowerOff Metering Shower Valve and Trim • Integral service stop • Adjustable run time • Vandal resistant • 1/2" sweat connections 	<i>Valve & Trim: 4-420-BODY included</i> 4-420	Chrome	704.80
		<i>Trim Only: 4-420-BODY required</i> 4-420-TRM	Chrome	184.60
				
	<ul style="list-style-type: none"> • ShowerOff Metering Shower Valve and Trim • Integral service stop • Adjustable run time • Vandal resistant • 1/2" rear IPS connections 	<i>Valve & Trim: 4-427-BODY included</i> 4-427	Chrome	832.75
		<i>Trim Only: 4-427-BODY required</i> 4-427-TRM	Chrome	203.25
				
	<ul style="list-style-type: none"> • ShowerOff Metering Shower Valve and Trim • Integral service stop • Adjustable run time • Rear mounting escutcheon • Vandal resistant • 1/2" rear IPS connections 	<i>Valve & Trim: 4-427-BODY included</i> 4-427R	Chrome	978.50
		<i>Trim Only: 4-427-BODY required</i> 4-427R-TRM	Chrome	351.70
				
	<ul style="list-style-type: none"> • ShowerOff Metering Shower Valve and Trim • Integral service stop for steel wall installations • Adjustable run time • Vandal resistant • 1/2" IPS connections 	<i>Valve & Trim: 4-428-BODY included</i> 4-428	Chrome	1029.70
		<i>Trim Only: 4-428-BODY required</i> 4-428-TRM	Chrome	403.85
				

ShowerOff® Metering Shower Systems



DESCRIPTION	MODEL	FINISH	PRICE
<ul style="list-style-type: none"> • ShowerOff Metering Shower Valve and Trim • Integral service stop • Adjustable run time • Rear mounting escutcheon • Vandal resistant • 1/2" IPS connections 	<i>Valve & Trim: 4-428-BODY included</i>		
	4-428-R	Chrome	1059.25
	<i>Trim Only: 4-428-BODY required</i>		
	4-428-R-TRM	Chrome	433.95



ShowerOff® Exposed Metering Shower System

	DESCRIPTION	MODEL	FINISH	PRICE
	<ul style="list-style-type: none"> • ShowerOff Exposed Metering Shower System • 4-425 valve • Integral service stop • Adjustable run time • 20" head riser • 1/2" wall union • 4-285 single-function showerhead • Vandal resistant • 2.0 gpm (7.6 L/min) flow rate 	3-330	Chrome	1753.80



	<ul style="list-style-type: none"> • ShowerOff Exposed Metering Shower Valve and Trim • Integral service stop • Adjustable run time • Wall flange • Vandal resistant • 1/2" IPS connections 	4-425	Chrome	1110.20
---	---	-------	--------	---------



Modifications for ShowerOff Metering Shower Systems

SUFFIX	DESCRIPTION	PRICE
1.5	 1.5 gpm (5.7 L/min) flow restrictor	N/C
A	Anchor plates for showerhead for use with ceramic tile	109.80
B	Back plates and bolts for showerhead	237.65

Heavy Duty Faucets









Symmons offers a complete line of Heavy Duty faucets for use in your next educational, healthcare or public use applications. Metal exterior components coupled with Symmons reliability behind the wall and under the deck; Heavy Duty products withstand rigors of any high traffic areas.

Available in these finishes:









Various finishes by product







Heavy Duty Faucets

	DESCRIPTION	MODEL	FINISH	PRICE
	<ul style="list-style-type: none"> • Symmetrix Single Handle Centerset Lavatory Faucet 	S202PP	Chrome	244.55
	<ul style="list-style-type: none"> • 3-hole installation with 4" center • Red and blue handle indicators • 3/8" braided hose connections • Ceramic cartridges • Metal construction • Metal push-pop drain assembly included • 1.0 gpm (3.8 L/min) flow rate 	S202STNPP	Satin Nickel	387.80
				
	<ul style="list-style-type: none"> • Symmetrix Single Handle Centerset Lavatory Faucet 	S202G	Chrome	244.55
	<ul style="list-style-type: none"> • 3-hole installation with 4" center • Red and blue handle indicators • 3/8" braided hose connections • Ceramic cartridges • Metal construction • Metal grid drain assembly included • 1.0 gpm (3.8 L/min) flow rate 	S202STNG	Satin Nickel	317.90
				
	<ul style="list-style-type: none"> • Symmetrix Two Handle Centerset Lavatory Faucet 	S2402PP	Chrome	317.15
	<ul style="list-style-type: none"> • 3-hole installation with 4" center • Red and blue handle indicators • 1/2" IPS connections • Ceramic cartridges • Metal construction • Metal push-pop drain assembly included • 1.0 gpm (3.8 L/min) flow rate 			
	<ul style="list-style-type: none"> • Symmetrix Two Handle Centerset Lavatory Faucet 	S2402LAMPP	Chrome	344.50
	<ul style="list-style-type: none"> • 3-hole installation with 4" center • Red and blue handle indicators • 1/2" IPS connections • Ceramic cartridges • Metal construction • Metal push-pop drain assembly included • 1.0 gpm (3.8 L/min) flow rate 			
				







Heavy Duty Faucets

	DESCRIPTION	MODEL	FINISH	PRICE
	<ul style="list-style-type: none"> • Symmetrix Two Handle Centerset Lavatory Faucet • 3-hole installation with 4" center • Red and blue handle indicators • 1/2" IPS connections • Ceramic cartridges • Metal construction • Metal grid drain included • 1.0 gpm (3.8 L/min) flow rate 	S2402LAMG	Chrome	344.50
				
	<ul style="list-style-type: none"> • Symmetrix Two Handle Centerset Lavatory Faucet • 3-hole installation with 4" center • Red and blue handle indicators • 1/2" IPS connections • Ceramic cartridges • Metal construction • Metal push-pop drain assembly included • 1.0 gpm (3.8 L/min) flow rate 	S2402LWGPP	Chrome	344.50
				
	<ul style="list-style-type: none"> • Symmetrix Two Handle Centerset Lavatory Faucet • 3-hole installation with 4" center • Red and blue handle indicators • 1/2" IPS connections • Ceramic cartridges • Metal construction • Metal grid drain included • 1.0 gpm (3.8 L/min) flow rate 	S2402LWGG	Chrome	344.50
	<ul style="list-style-type: none"> • Symmetrix Two Handle Centerset Lavatory Faucet • 3-hole installation with 4" center • Red and blue handle indicators • 1/2" IPS connections • Ceramic cartridges • Metal construction • Metal push-pop drain assembly included • 1.0 gpm (3.8 L/min) flow rate 	S2502PP	Chrome	294.30
				

Heavy Duty Faucets

	DESCRIPTION	MODEL	FINISH	PRICE
	<ul style="list-style-type: none"> • Symmetrix Two Handle Centerset Lavatory Faucet • 3-hole installation with 4" center • Red and blue handle indicators • 1/2" IPS connections • Ceramic cartridges • Metal construction • Metal grid drain included • 1.0 gpm (3.8 L/min) flow rate 	S2502G	Chrome	294.30
				
	<ul style="list-style-type: none"> • Symmetrix Two Handle Centerset Lavatory Faucet • 3-hole installation with 4" center • Red and blue handle indicators • 1/2" IPS connections • Ceramic cartridges • Metal construction • Metal grid drain included • 1.0 gpm (3.8 L/min) flow rate 	S2502G	Chrome	294.30
	<ul style="list-style-type: none"> • Symmetrix Two Handle Centerset Lavatory Faucet • 3-hole installation with 4" center • Red and blue handle indicators • 1/2" IPS connections • Ceramic cartridges • Metal construction • Metal push-pop drain assembly included • 1.0 gpm (3.8 L/min) flow rate 	S2502PPLWG	Chrome	294.30
				
	<ul style="list-style-type: none"> • Symmetrix Two Handle Centerset Lavatory Faucet • 3-hole installation with 4" center • Red and blue handle indicators • 1/2" IPS connections • Ceramic cartridges • Metal construction • Metal grid drain included • 1.0 gpm (3.8 L/min) flow rate 	S2502GLWG	Chrome	294.30
				

Heavy Duty Faucets

	DESCRIPTION	MODEL	FINISH	PRICE
	<ul style="list-style-type: none"> • Symmetrix Two Handle Laundry Faucet • 3-hole installation with 4" center • Red and blue handle indicators • 7-5/8" x 7" inch swivel spout • 1/2" IPS connections • Hose thread connection on spout • Ceramic cartridges • Metal construction • 1.5 gpm (5.7 L/min) flow rate 	S-249	Chrome	190.80
				
	<ul style="list-style-type: none"> • Symmetrix Two Handle Service Sink Faucet • Wall mount • Ceramic cartridges • 1/2" IPS inlet connections • Vandal resistant • Mop bucket hook on spout 	S-2490	Rough Chrome	258.60
				
	<ul style="list-style-type: none"> • Symmetrix Two Handle Service Sink Faucet • Wall mount • Integral check valves • Ceramic cartridges • 1/2" IPS inlet connections • Vandal resistant • Mop bucket hook on spout 	S-2490-CHKS	Rough Chrome	283.05
				

Modifications for Lavatory and Bar Sink Faucets

SUFFIX	DESCRIPTION	PRICE
05	 0.5 gpm (1.9 L/min) vandal resistant flow restrictor	N/A
DP4	4" deck plate for single hole mount faucets	45.80

ActivSense® Collection

ActivSense®



Sensor-activated lavatory faucets can be expensive, ineffective, and difficult to install. That's why we created our line of ActivSense® faucets and soap dispensers. Their ultra-responsive sensors put an end to the frustrating hand-waving. Installation is a snap with multiple power and deck plate options.

Available in these finishes

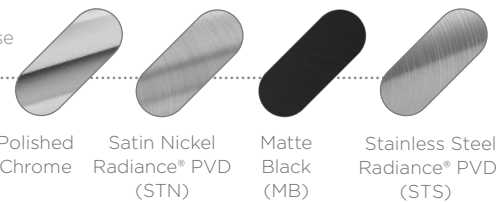

Polished
Chrome

Satin Nickel
Radiance® PVD
(STN)

Matte
Black
(MB)

Stainless Steel
Radiance® PVD
(STS)

Sensor Faucets & Soap Dispensers

ActivSense® Battery Powered Sensor Faucets

	DESCRIPTION	MODEL	FINISH	PRICE	
	• ActivSense Origins Sensor Faucet	S6960B	Chrome	718.90	
	• Single supply for cold or tempered water	S6960BSTS	Stainless Steel	934.45	
	• Includes optional 4" deck plate				
	• Battery operated, 6 AA batteries included				
	• Press fit, waterproof electrical connectors				
	• Programmable security time with optional remote control RC6960 (not included)				
	• Hygiene flush function activated with optional remote control RC6960 (not included)				
	• 0.5 gpm (1.89 L/min) standard				
					
		• ActivSense Dia Sensor Faucet	S6350B	Chrome	1054.35
• Single supply for cold or tempered water		S6350BSTN	Satin Nickel	1370.65	
• Battery operated, 6 AA batteries included		S6350BMB	Matte Black	1476.00	
• Press fit, waterproof electrical connectors					
• Programmable security time with optional remote control RC6960 (not included)					
• Hygiene flush function activated with optional remote control RC6960 (not included)					
• 0.5 gpm (1.89 L/min) standard					
• Includes 0.35 gpm (1.35 L/min) and 1.0 gpm (3.79 L/min) aerators in the box					
					
		• ActivSense Duro Sensor Faucet	S6360B	Chrome	1054.35
	• Single supply for cold or tempered water	S6360BSTN	Satin Nickel	1370.65	
	• Battery operated, 6 AA batteries included	S6360BMB	Matte Black	1476.00	
	• Press fit, waterproof electrical connectors				
	• Programmable security time with optional remote control RC6960 (not included)				
	• Hygiene flush function activated with optional remote control RC6960 (not included)				
	• 0.5 gpm (1.89 L/min) standard				
	• Includes 0.35 gpm (1.35 L/min) and 1.0 gpm (3.79 L/min) aerators in the box				
					

ActivSense® Battery Powered Sensor Faucets

ActivSense®



DESCRIPTION	MODEL	FINISH	PRICE
• ActivSense Sereno Sensor Faucet	S6430B	Chrome	1054.35
• Single supply for cold or tempered water	S6430BSTS	Stainless Steel	1370.65
• Includes optional 4" deck plate			
• Battery operated, 6 AA batteries included			
• Press fit, waterproof electrical connectors			
• Programmable security time with optional remote control RC6960 (not included)			
• Hygiene flush function activated with optional remote control RC6960 (not included)			
• 0.5 gpm (1.89 L/min) flow rate			



ActivSense® AC Powered Sensor Faucets

	DESCRIPTION	MODEL	FINISH	PRICE		
	<ul style="list-style-type: none"> • ActivSense Origins Sensor Faucet • Single supply for cold or tempered water • Includes optional 4" deck plate • Plug-in power supply 9V • Press fit, waterproof electrical connectors • Programmable security time with optional remote control RC6960 (not included) • Hygiene flush function activated with optional remote control RC6960 (not included) • 0.5 gpm (1.89 L/min) standard 	<ul style="list-style-type: none"> S6960E S6969ESTS 	<ul style="list-style-type: none"> Chrome Stainless Steel 	<ul style="list-style-type: none"> 766.20 996.05 		
						
		<ul style="list-style-type: none"> • ActivSense Dia Sensor Faucet • Single supply for cold or tempered water • Plug-in power supply 9V • Press fit, waterproof electrical connectors • Programmable security time with optional remote control RC6960 (not included) • Hygiene flush function activated with optional remote control RC6960 (not included) • 0.5 gpm (1.89 L/min) standard • Includes 0.35 gpm (1.35 L/min) and 1.0 gpm (3.79 L/min) aerators in the box 	<ul style="list-style-type: none"> S6350E S6350ESTN S6350EMB 	<ul style="list-style-type: none"> Chrome Satin Nickel Matte Black 	<ul style="list-style-type: none"> 1101.60 1417.90 1523.30 	
						
			<ul style="list-style-type: none"> • ActivSense Duro Sensor Faucet • Single supply for cold or tempered water • Plug-in power supply 9V • Press fit, waterproof electrical connectors • Programmable security time with optional remote control RC6960 (not included) • Hygiene flush function activated with optional remote control RC6960 (not included) • 0.5 gpm (1.89 L/min) standard • Includes 0.35 gpm (1.35 L/min) and 1.0 gpm (3.79 L/min) aerators in the box 	<ul style="list-style-type: none"> S6360E S6360ESTN S6360EMB 	<ul style="list-style-type: none"> Chrome Satin Nickel Matte Black 	<ul style="list-style-type: none"> 1101.60 1417.90 1476.00
						

ActivSense® AC Powered Sensor Faucets







ActivSense®



DESCRIPTION	MODEL	FINISH	PRICE
<ul style="list-style-type: none"> • ActivSense Sereno Sensor Faucet 	S6430E	Chrome	1101.60
<ul style="list-style-type: none"> • Single supply for cold or tempered water 	S6430ESTS	Stainless Steel	1417.90
<ul style="list-style-type: none"> • Includes optional 4" deck plate • Plug-in power supply 9V • Press fit, waterproof electrical connectors • Programmable security time with optional remote control RC6960 (not included) • Hygiene flush function activated with optional remote control RC6960 (not included) • 0.5 gpm (1.89 L/min) flow rate 			



ActivSense® Battery Powered Soap Dispensers

	DESCRIPTION	MODEL	FINISH	PRICE	
	• ActivSense Origins Soap Dispenser	SD6960BL	Chrome	803.50	
	• Liquid soap	SD6960BLSTS	Stainless Steel	1044.60	
	• Battery operated, 6D batteries included				
	• Press fit, waterproof electrical connectors				
	• Peristaltic pump for drip-free close				
	• Programmable sensor range with optional remote control RC6960SDL (not included)				
	• Programmable soap amount with optional remote control RC6960SDL (not included)				
	• Viscosity range 100-3800 Cps				
					
		• ActivSense Dia Soap Dispenser	SD6350BL	Chrome	838.65
• Liquid soap		SD6350BLSTN	Satin Nickel	1090.20	
• Battery operated, 6D batteries included		SD6350BLMB	Matte Black	1174.10	
• Press fit, waterproof electrical connectors					
• Peristaltic pump for drip-free close					
• Programmable sensor range with optional remote control RC6960SDL (not included)					
• Programmable soap amount with optional remote control RC6960SDL (not included)					
• Viscosity range 100-3800 Cps					
					
		• ActivSense Duro Soap Dispenser	SD6360BL	Chrome	886.55
	• Liquid soap	SD6360BLSTN	Satin Nickel	1152.50	
	• Battery operated, 6D batteries included	SD6360BLMB	Matte Black	1241.30	
	• Press fit, waterproof electrical connectors				
	• Peristaltic pump for drip-free close				
	• Programmable sensor range with optional remote control RC6960SDL (not included)				
	• Programmable soap amount with optional remote control RC6960SDL (not included)				
	• Viscosity range 100-3800 Cps				
					



ActivSense® Battery Powered Soap Dispensers











DESCRIPTION	MODEL	FINISH	PRICE
<ul style="list-style-type: none"> • ActivSense Sereno Soap Dispenser 	SD6430BL	Chrome	838.65
<ul style="list-style-type: none"> • Liquid soap 	SD6430BLSTS	Stainless Steel	1090.30
<ul style="list-style-type: none"> • Battery operated, 6D batteries included • Press fit, waterproof electrical connectors • Peristaltic pump for drip-free close • Programmable sensor range with optional remote control RC6960SDL (not included) • Programmable soap amount with optional remote control RC6960SDL (not included) • Viscosity range 100-3800 Cps 			



ActivSense® AC Powered Soap Dispenser

	DESCRIPTION	MODEL	FINISH	PRICE
	• ActivSense Origins Soap Dispenser	SD6960EL	Chrome	849.25
	• Liquid soap	SD6960ELSTS	Stainless Steel	1103.95
	• Plug-in power supply 12V			
	• Press fit, waterproof electrical connectors			
	• Peristaltic pump for drip-free close			
	• Programmable sensor range with optional remote control RC6960SDL (not included)			
	• Programmable soap amount with optional remote control RC6960SDL (not included)			
	• Viscosity range 100-3800 Cps			
		 		

	• ActivSense Dia Soap Dispenser	SD6350EL	Chrome	884.35
	• Liquid soap	SD6350ELSTN	Satin Nickel	1135.90
	• Plug-in power supply 12V	SD6350ELMB	Matte Black	1221.40
	• Press fit, waterproof electrical connectors			
	• Peristaltic pump for drip-free close			
	• Programmable sensor range with optional remote control RC6960SDL (not included)			
	• Programmable soap amount with optional remote control RC6960SDL (not included)			
	• Viscosity range 100-3800 Cps			
		  		

	• ActivSense Duro Soap Dispenser	SD6360EL	Chrome	933.85
	• Liquid soap	SD6360ELSTN	Satin Nickel	1199.75
	• Plug-in power supply 12V	SD6360ELMB	Matte Black	1288.55
	• Press fit, waterproof electrical connectors			
	• Peristaltic pump for drip-free close			
	• Programmable sensor range with optional remote control RC6960SDL (not included)			
	• Programmable soap amount with optional remote control RC6960SDL (not included)			
	• Viscosity range 100-3800 Cps			
		  		

ActivSense® AC Powered Soap Dispenser

ActivSense®



DESCRIPTION	MODEL	FINISH	PRICE
• ActivSense Sereno Soap Dispenser	SD6430EL	Chrome	881.85
• Liquid soap	SD6430ELSTS	Stainless Steel	1130.80
• Plug-in power supply 12V			
• Press fit, waterproof electrical connectors			
• Peristaltic pump for drip-free close			
• Programmable sensor range with optional remote control RC6960SDL (not included)			
• Programmable soap amount with optional remote control RC6960SDL (not included)			
• Viscosity range 100-3800 Cps			



ActivSense® Accessories

	DESCRIPTION	MODEL	FINISH	PRICE
	<ul style="list-style-type: none"> • ActivSense Faucet Remote • Controls all ActivSense sensor faucets • Adjusts sensor detection range • Adjusts security time • Temporary off function allows for cleaning and servicing • Self-Adjustment mode automatically sets ideal sensor range for each location • Reset returns faucet to factory settings • 24-hour hygiene flush 	RC6960	N/A	168.95
	<ul style="list-style-type: none"> • ActivSense Soap Dispenser Remote • Controls all ActivSense liquid soap dispensers • Adjusts soap dispensing quantity • Temporary off function allows for cleaning and servicing • Fill button primes dispenser for use • Adjustment button (Adj.) returns soap dispenser to factory settings 	RC6960SDL	N/A	95.65
	<ul style="list-style-type: none"> • 12V Plug-In Adaptor • Convert faucet or soap dispenser to AC power • Connects to same waterproof connector as battery box • Powers one device only 	SD010	N/A	37.75
	<ul style="list-style-type: none"> • Junction Box with Transformer • Power up to 10 faucets or 10 soap dispensers • 120V: 10ea 12V outputs • 4.5 foot cable • Hardwired 15 Amp circuit 	SF278	N/A	350.55

SCOT®/Metering Faucets

SCOT®



Heavy duty, cast brass body and stainless steel parts are standard with all Symmons SCOT/Metering Faucets. The self-cleaning brass cartridge provides a reliable flow with user-adjustable water temperature or tempered water options available to improve water efficiency and energy costs. Ideal for healthcare, institutional and public use applications.







Available in this finish:



Polished Chrome

SCOT/Metering Faucets

SCOT®/Metering Faucets (with Temperature Selection)

	DESCRIPTION	MODEL	FINISH	PRICE
	<ul style="list-style-type: none"> • Brass Metering Faucet with Lever Handle • 4" centerset mount • 3/8" copper hot and cold supply lines • Temperature limit stop • Adjustable flow time • Metal grid drain assembly included • Vandal resistant 0.5 gpm (1.9 L/min) aerator limits water flow to a maximum of 0.25 gpc (0.95 L/cyl) 	SLC-6000-G	Chrome	796.80
				
	<ul style="list-style-type: none"> • Brass Metering Faucet with Lever Handle • 4" centerset mount • 3/8" copper hot and cold supply lines • Temperature limit stop • Adjustable flow time • Drain assembly not included • Vandal resistant 0.5 gpm (1.9 L/min) aerator limits water flow to a maximum of 0.25 gpc (0.95 L/cyl) 	SLC-6000	Chrome	784.50
				
	<ul style="list-style-type: none"> • Brass Metering Faucet with Lever Handle • 8" centerset mount • 3/8" copper hot and cold supply lines • Temperature limit stop • Adjustable flow time • Drain assembly not included • Vandal resistant 0.5 gpm (1.9 L/min) aerator limits water flow to a maximum of 0.25 gpc (0.95 L/cyl) 	SLC-6000-DP	Chrome	924.35
				

Modifications for all SCOT Metering Faucets (SLC-6000 Series)

SUFFIX	DESCRIPTION	PRICE
0.35	 0.35 gpm (1.3 L/min) vandal resistant flow restrictor	N/C
DP	Adaptor plate to convert to 8" centerset	130.05
G	Grid drain	17.45
ML	MaxLine® thermostatic mixing valve for temperature selection	100.00
OFG	Offset grid strainer in place of standard grid strainer (SLC-6000-G only)	48.65
QC	Quick close cartridge	N/C
STE	Supply tube extensions, 8" with compression couplings	25.45

Metering Faucets (without Temperature Selection)

	DESCRIPTION	MODEL	FINISH	PRICE
	<ul style="list-style-type: none"> • Brass Metering Faucet • Single-hole mount • 1/2" IPS male supply connections for cold or tempered water • Adjustable flow time • Drain assembly not included • Vandal resistant 0.5 gpm (1.9 L/min) aerator limits water flow to a maximum of 0.25 gpc (0.95 L/cyl) 	SLS-7000	Chrome	327.00
	   			
	<ul style="list-style-type: none"> • Brass Metering Faucet • Single-hole mount • 1/2" IPS male supply connections for cold or tempered water • Adjustable flow time • Metal grid drain assembly included • Vandal resistant 0.5 gpm (1.9 L/min) aerator limits water flow to a maximum of 0.25 gpc (0.95 L/cyl) 	SLS-7000-G	Chrome	339.35
	   			
	<ul style="list-style-type: none"> • Brass Metering Faucet • 4" mount • 1/2" IPS male supply connections for cold or tempered water • Adjustable flow time • Drain assembly not included • Vandal resistant 0.5 gpm (1.9 L/min) aerator limits water flow to a maximum of 0.25 gpc (0.95 L/cyl) 	SLS-7000-DP4	Chrome	396.90
	   			
	<ul style="list-style-type: none"> • Brass Metering Faucet • 4" mount • 1/2" IPS male supply connections for cold or tempered water • Adjustable flow time • Metal grid drain assembly included • Vandal resistant 0.5 gpm (1.9 L/min) aerator limits water flow to a maximum of 0.25 gpc (0.95 L/cyl) 	SLS-7000-DP4-G	Chrome	409.20
	  			

Modifications for all Metering Faucets (SLS-7000 Series)

SUFFIX	DESCRIPTION	PRICE
0.35	 0.35 gpm (1.3 L/min) vandal resistant flow restrictor	N/C
C	Cold marking on cap in place of standard cap	N/C
DP	Adaptor plate to convert to 8" centerset	110.60
DP4	Adaptor plate to convert to 4" centerset	66.95
G	Grid drain	17.45
H	Hot marking on cap in place of standard cap	N/C
ML	MaxLine® thermostatic mixing valve for temperature selection	103.00
OFG	Offset grid strainer in place of standard grid strainer (SLS-7000-G, SLS-7000-DP4-G, SLS-7000-MV-G only)	47.80
QC	Quick close cartridge	N/C

MaxLine®



MaxLine®



Symmons recognizes that safety and reliability are important factors when selecting a Thermostatic Mixing Valve.

MaxLine's durable design and trusted engineering provides our customers with industry leading scald protection and quality that is synonymous with the Symmons brand.

Thermostatic Water Temperature Limiting Devices

Flow Rates and Sizing













FLOW RATE - gpm (L/min)								
Valve Model	Size Connection	Min Flow Rate	PRESSURE DIFFERENTIAL - psi (kPA)					
			5 psi (34 kPA)	10 psi (69 kPA)	20 psi (138 kPA)	25 psi (172 kPA)	30 psi (207 kPA)	45 psi (310 kPA)
8210CK	3/8" compression (10mm)	0.25 gpm (0.95L/min)	1 gpm (3.8 L/min)	2 gpm (7.6 L/min)	3 gpm (11.4 L/min)	3.5 gpm (13.2 L/min)	4 gpm (15.1 L/min)	5 gpm (18.9 L/min)
7-225-CK-MS	1/2" male NPT 1/2" female sweat (13mm)	0.5 gpm (1.9 L/min)	4.5 gpm (17 L/min)	7 gpm (26.5 L/min)	9.5 gpm (36 L/min)	10.5 gpm (39.8 L/min)	12 gpm (45.4 L/min)	14 gpm (53 L/min)
7-225-CK-F	1/2" female NPT (13mm)	0.5 gpm (1.9 L/min)	4.5 gpm (17 L/min)	7 gpm (26.5 L/min)	9.5 gpm (36 L/min)	10.5 gpm (39.8 L/min)	12 gpm (45.4 L/min)	14 gpm (53 L/min)
7-225-CK-PEX	1/2" PEX (13mm)	0.5 gpm (1.9 L/min)	3.5 gpm (13.2 L/min)	5.5 gpm (20.8 L/min)	8 gpm (30.3 L/min)	8.5 gpm (32.2 L/min)	9.5 gpm (36 L/min)	12 gpm (45.4 L/min)
7-230-CK-M	3/4" male NPT (19mm)	0.5 gpm (1.9 L/min)	5 gpm (19 L/min)	7 gpm (26.5 L/min)	10 gpm (37.9 L/min)	11 gpm (41.6 L/min)	12 gpm (45.4 L/min)	14 gpm (53 L/min)
7-230-CK-FS	3/4" female sweat (19mm)	0.5 gpm (1.9 L/min)	5 gpm (19 L/min)	7 gpm (26.5 L/min)	10 gpm (37.9 L/min)	11 gpm (41.6 L/min)	12 gpm (45.4 L/min)	14 gpm (53 L/min)

Proper Sizing







Thermostatic water controllers should be sized according to the flow capacity required from the valve, NOT the pipe size supplied to the valve. The pressure differential shown above represents the actual pressure drop across the valve to produce a given flow rate. The frictional loss associated with the valve is incorporated into the flow rate figures. For assistance and technical support in sizing and selection of the proper MaxLine Thermostatic Water Temperature Limiting Device, consult your local representative or Symmons Customer Service Department at 1-800-SYMMONS.

MaxLine® Thermostatic Water Temperature Limiting Valves



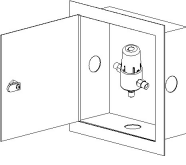
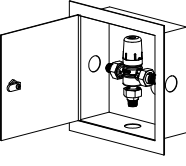

MaxLine®

	DESCRIPTION	MODEL	FINISH	PRICE
	<ul style="list-style-type: none"> • MaxLine Thermostatic Mixing Valve • 3/8" compression connection • ASSE 1070/1017, CSA B125.3 certified • Brass construction • Vandal resistant temperature adjustment cap • Temp. control range 70F - 130F • Min. flow rate 0.25 gpm 	8210CK	Chrome	141.40
	 			
	<ul style="list-style-type: none"> • MaxLine Thermostatic Mixing Valve • 1/2" male sweat connection • ASSE 1017/1070, CSA B125.3 certified • Lead-free brass construction • Thermal cartridge • Vandal resistant • Temp. control range 60-140 F • Min. flow rate 0.5 gpm 	7-225-CK-MS	Chrome	269.15
	 			
	<ul style="list-style-type: none"> • MaxLine Thermostatic Mixing Valve • 1/2" female NPT connection • ASSE 1017/1070, CSA B125.3 certified • Lead-free brass construction • Thermal cartridge • Vandal resistant • Temp. control range 60-140 F • Min. flow rate 0.5 gpm 	7-225-CK-F	Chrome	269.15
	 			
	<ul style="list-style-type: none"> • MaxLine Thermostatic Mixing Valve • 1/2" PEX connection • ASSE 1017/1070, CSA B125.3 certified • Lead-free brass construction • Thermal cartridge • Vandal resistant • Temp. control range 60-140 F • Min. flow rate 0.5 gpm 	7-225-CK-PEX	Chrome	269.15
	 			

MaxLine® Thermostatic Water Temperature Limiting Valves

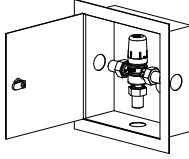
	DESCRIPTION	MODEL	FINISH	PRICE
	<ul style="list-style-type: none"> • MaxLine Thermostatic Mixing Valve • 3/4" male NPT connection • ASSE 1017/1070, CSA B125.3 certified • Lead-free brass construction • Thermal cartridge • Vandal resistant • Temp. control range 60-140 F • Min. flow rate 0.5 gpm 	7-230-CK-M	Chrome	333.05
				
	<ul style="list-style-type: none"> • MaxLine Thermostatic Mixing Valve • 3/4" female sweat connection • ASSE 1017/1070, CSA B125.3 certified • Lead-free brass construction • Thermal cartridge • Vandal resistant • Temp. control range 60-140 F • Min. flow rate 0.5 gpm 	7-230-CK-FS	Chrome	333.05
				
	<ul style="list-style-type: none"> • MaxLine Thermostatic Mixing Valve with Cabinet • 3/8" compression connection • ASSE 1070/1017, CSA B125.3 certified • Brass construction • Vandal resistant temperature adjustment cap • Full recessed steel cabinet with white enamel finish • Temp. control range 70F - 130F • Min. flow rate 0.25 gpm 	8210BCK	Chrome	895.20
	<ul style="list-style-type: none"> • MaxLine Thermostatic Mixing Valve with Cabinet • 1/2" copper sweat connection • ASSE 1017/1070, CSA B125.3 certified • Lead-free brass construction • Thermal cartridge • Vandal resistant temperature adjustment handle • Fully recessed steel cabinet with white enamel finish • Temp. control range 60-140 F • Min. flow rate 0.5 gpm 	7-225B-CK-MS	Chrome	974.85
				

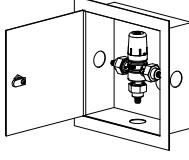
MaxLine® Thermostatic Water Temperature Limiting Valves

	DESCRIPTION	MODEL	FINISH	PRICE	
		<ul style="list-style-type: none"> • MaxLine Thermostatic Mixing Valve with Cabinet • 1/2" female NPT connection • ASSE 1017/1070, CSA B125.3 certified • Lead-free brass construction • Thermal cartridge • Vandal resistant temperature adjustment handle • Fully recessed steel cabinet with white enamel finish • Temp. control range 60-140 F • Min. flow rate 0.5 gpm 	7-225B-CK-F	Chrome	974.85
			<ul style="list-style-type: none"> • MaxLine Thermostatic Mixing Valve with Cabinet • 1/2" PEX connection • ASSE 1017/1070, CSA B125.3 certified • Lead-free brass construction • Thermal cartridge • Vandal resistant temperature adjustment handle • Fully recessed steel cabinet with white enamel finish • Temp. control range 60-140 F • Min. flow rate 0.5 gpm 	7-225B-CK-PEX	Chrome
		<ul style="list-style-type: none"> • MaxLine Thermostatic Mixing Valve with Cabinet • 3/4" male NPT connection • ASSE 1017/1070, CSA B125.3 certified • Lead-free brass construction • Thermal cartridge • Vandal resistant temperature adjustment handle • Fully recessed steel cabinet with white enamel finish • Temp. control range 60-140 F • Min. flow rate 0.5 gpm 	7-230B-CK-M	Chrome	1038.30
					

MaxLine® Thermostatic Water Temperature Limiting Valves

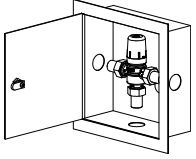
	DESCRIPTION	MODEL	FINISH	PRICE
	<ul style="list-style-type: none"> • MaxLine Thermostatic Mixing Valve with Cabinet • 3/4" female sweat connection • ASSE 1017/1070, CSA B125.3 certified • Lead-free brass construction • Thermal cartridge • Vandal resistant temperature adjustment handle • Fully recessed steel cabinet with white enamel finish • Temp. control range 60-140 F • Min. flow rate 0.5 gpm 	7-230B-CK-FS	Chrome	1038.30



Modifications for all MaxLine Thermostatic Water Temperature Limiting Valves

SUFFIX	DESCRIPTION	PRICE
D	3/8" compression tee fitting to allow water bypass for hot and cold supply faucet (8210CK only)	15.80
NI	Rough nickel finish	32.85
T	Stainless steel cabinet in place of standard white cabinet	206.75
X	Separate stops (7-225-CK-MS only)	32.40

TempControl®

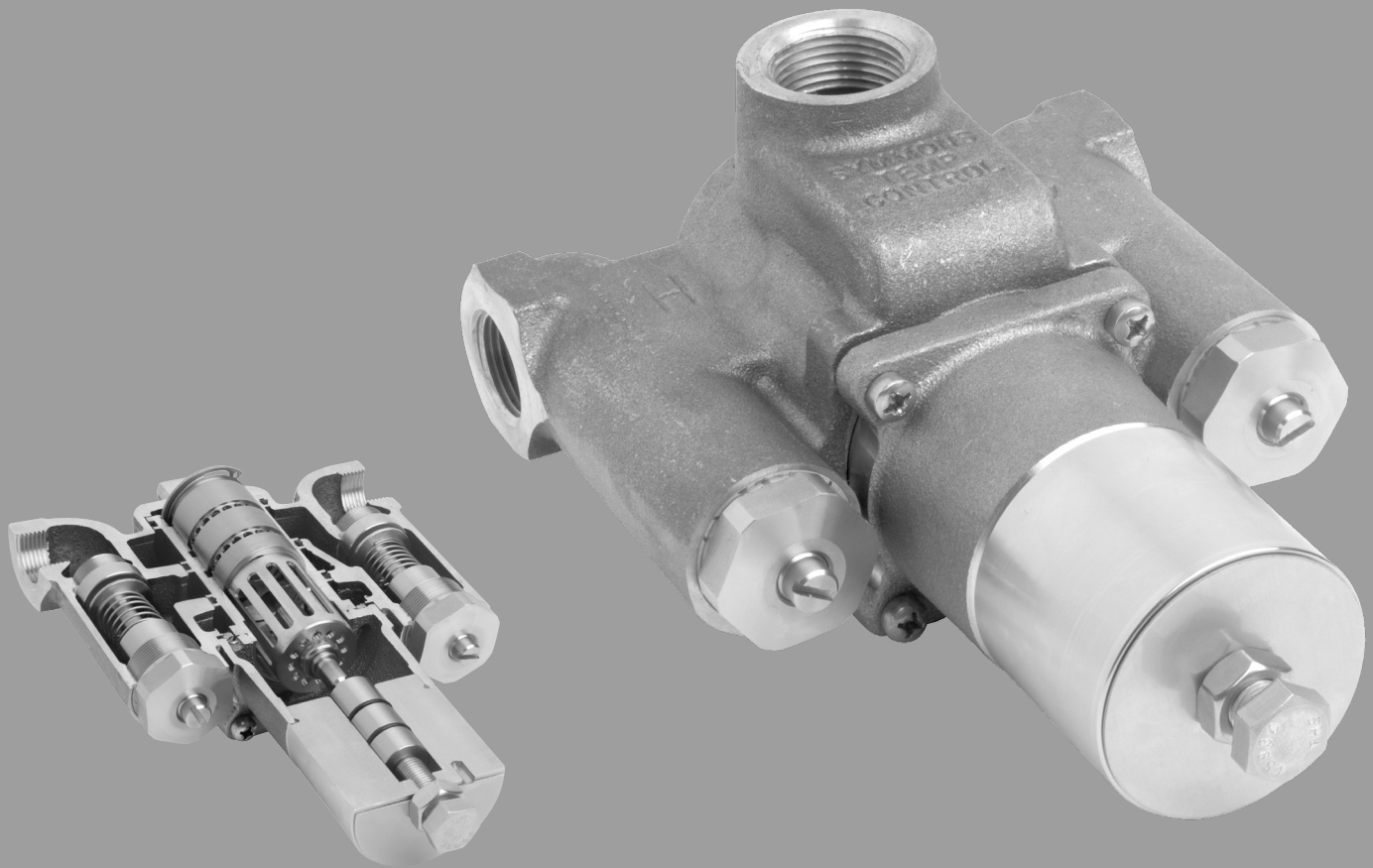

The brass, bronze and stainless steel components of the 7 Series TempControl Lead Free* valves allow for precise temperature control. The tamper-resistant hex bolt combined with the optional cabinets help prevent unwanted temperature adjustments. Several “factory assembled and tested” options available.

*According to US Senate bill S.3874, the term “lead free” is defined as follows: “not more than a weighted average of 0.25 percent lead when used with respect to the wetted surfaces of pipes, pipefittings, plumbing fittings, and fixtures”.

Thermostatic Water Controllers

Flow Rates and Sizing

FLOW RATE - gpm (L/min)								
Valve Model	Min Flow Rate*	Min Flow Rate (per ASSE 1017)	PRESSURE DIFFERENTIAL - psi (kPA)					
			5 psi (34 kPA)	10 psi (69 kPA)	20 psi (138 kPA)	25 psi (172 kPA)	30 psi (207 kPA)	45 psi (310 kPA)
7-102	0.5 gpm (1.9 L/min)	0.5 gpm (1.9 L/min)	1 gpm (3.8 L/min)	3 gpm (11.4 L/min)	6 gpm (22.7 L/min)	7 gpm (26.5 L/min)	8 gpm (30.3 L/min)	11 gpm (41.6 L/min)
7-200	0.5 gpm (1.9 L/min)	5 gpm (18.9 L/min)	7 gpm (26.5 L/min)	12 gpm (45.4 L/min)	18 gpm (64.4 L/min)	21 gpm (75.7 L/min)	23 gpm (83.3 L/min)	27 gpm (102.2 L/min)
7-400	0.5 gpm (1.9 L/min)	9 gpm (34.1 L/min)	18 gpm (64.4 L/min)	27 gpm (102.2 L/min)	37 gpm (140.1 L/min)	41 gpm (155.2 L/min)	44 gpm (166.6 L/min)	53 gpm (200.6 L/min)
7-500	0.5 gpm (1.9 L/min)	13 gpm (49.2 L/min)	22 gpm (83.3 L/min)	38 gpm (143.8 L/min)	50 gpm (189.3 L/min)	55 gpm (208.2 L/min)	59 gpm (223.3 L/min)	70 gpm (265 L/min)
7-700	0.5 gpm (1.9 L/min)	13 gpm (49.2 L/min)	25 gpm (94.6 L/min)	43 gpm (162.8 L/min)	57 gpm (215.8 L/min)	62 gpm (234.7 L/min)	66 gpm (249.8 L/min)	77 gpm (291.5 L/min)
7-900	0.5 gpm (1.9 L/min)	13 gpm (49.2 L/min)	30 gpm (113.6 L/min)	55 gpm (208.2 L/min)	76 gpm (287.7 L/min)	84 gpm (318 L/min)	89 gpm (336.9 L/min)	104 gpm (393.7 L/min)
7-1000	0.5 gpm (1.9 L/min)	13 gpm (49.2 L/min)	38 gpm (143.8 L/min)	67 gpm (253.6 L/min)	100 gpm (378.5 L/min)	111 gpm (420.2 L/min)	120 gpm (454.2 L/min)	140 gpm (529.9 L/min)

*Minimum flow rate when valve is installed at or near the hot water source with recirculated tempered water and continuously operating circulating pump.

Note: The U.S. Department of Labor, Occupational Safety and Health Administration (OSHA) Technical Manual, Section II, Chapter 7, Legionnaire's Disease, recommends that due to concerns about the potential for growth of Legionella bacteria in stagnant pipe runs, "Domestic hot water recirculation pumps should run continuously. They should be excluded from energy conservation measures."

Proper Sizing

Thermostatic water controllers should be sized according to the flow capacity required from the valve, NOT the pipe size supplied to the valve. The pressure differential shown above represents the actual pressure drop across the valve to produce a given flow rate. The frictional loss associated with the valve is incorporated into the flow rate figures. For assistance and technical support in sizing and selection of the proper TempControl Thermostatic Water Controller, consult your local representative or Symmons Customer Service Department at 1-800-SYMMONS.

TEMPCONTROL Valves, Piping Assemblies and Cabinet Assemblies



ALL TEMPCONTROL VALVES QUALIFY FOR BUY AMERICAN

Tempcontrol valve sizes are as follows:

BASIC MODEL	IPS INLETS	IPS OUTLET
7-102	1/2"	1/2"
7-200	3/4"	3/4"
7-400	3/4"	1"
7-500	1"	1 1/4"
7-700	1 1/4"	1 1/2"
7-900	1 1/2"	1 1/2"
7-1000	1 1/2"	2"

Explanation of modification suffixes:

Suffix P	Polish chrome highlight finish
Suffix W	Wall mounting bracket
Suffix V	Vacuum breaker
Suffix M	Surface mounted cabinet
Suffix S	Semi recessed cabinet
Suffix T	Stainless steel cabinet
Suffix TOP	Top supplies
Suffix NI	Rough nickel finish
Suffix STN	Satin spray finish
Suffix STN/POL	Satin spray with polished chrome highlight finish
Suffix ASB	Factory assembled and tested

For modifications other than those listed, contact factory for pricing. When purchasing a TempControl Valve, it is recommended to purchase a spare cartridge for non-interrupted service. Standard cabinet is fully recessed steel with white finish. Standard valve and piping finish is rough bronze, brass or copper. Factory assembled and tested units are available in rough bronze, satin spray and satin spray with polished highlight finish with type L copper tubing.

Valve Only

MODIFICATIONS — Add to list price where applicable.

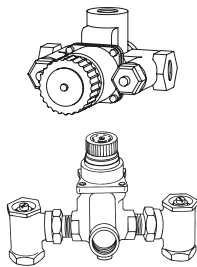

MODEL NO.	LIST PRICE	SUFFIX P	SUFFIX NI	SUFFIX W
7-102	1,478.85	254.55	INCLUDED	INCLUDED
7-200	1,546.75	221.95	81.85	125.65
7-400	1,963.25	221.95	81.85	126.65
7-500	2,605.30	281.60	120.90	125.65
7-700	2,646.85	281.60	120.90	125.65
7-900	3,164.15	319.75	152.25	177.45
7-1000	3,783.65	319.76	152.25	177.45

"A" Series, Valve and Piping Assembly

MODIFICATIONS — Add to list price where applicable.

*Unavailable in additional finishes with ASB suffix.

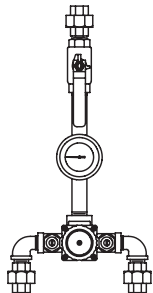

MODEL NO.	LIST PRICE	ASB	SUFFIX P*	SUFFIX NI*	SUFFIX W	SUFFIX V
7-102A	2,349.45	396.00	284.45	INCLUDED	INCLUDED	149.25
7-200A	2,479.20	396.00	338.65	228.60	125.65	155.50
7-400A	2,863.25	441.40	392.10	298.45	125.65	325.20
7-500A	3,534.80	441.40	500.05	358.10	125.65	365.95
7-700A	3,764.20	441.40	528.10	373.75	125.65	439.90
7-900A	4,314.05	441.40	609.50	471.30	177.45	439.90
7-1000A	4,904.10	457.20	677.20	497.85	177.45	752.50

"B" Series, Valve and Piping in Cabinet

MODIFICATIONS — Add to list price where applicable.

*When Suffix V or Suffix TOP are used in conjunction with Suffix P, add 30% to price of Suffix V or Suffix TOP.

*Suffix TOP cannot be used in conjunction with Suffix V.

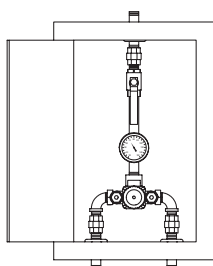

MODEL NO.	LIST PRICE	SUFFIX P	SUFFIX M,S	SUFFIX NI	SUFFIX T	*SUFFIX TOP	*SUFFIX V
7-102B	3,276.25	284.50	N/C	INCLUDED	677.20	154.65	149.25
7-200B	3,389.55	338.65	N/C	220.00	790.60	154.65	155.50
7-400B	4,144.10	392.90	N/C	298.45	790.60	154.65	171.90
7-500B	4,479.30	487.65	N/C	358.10	1,028.85	208.80	365.95
7-700B	4,707.00	528.15	N/C	358.10	1,028.85	281.60	439.90
7-900B	5,277.75	609.50	N/C	471.30	1,205.00	449.70	439.90
7-1000B	5,962.20	677.35	N/C	677.15	1,205.00	449.70	752.40

“B” Series, Valve and Piping in Cabinet (Factory assembled and tested)

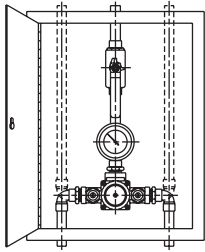

MODIFICATIONS — Add to list price and weight where applicable.

*Suffix TOP cannot be used in conjunction with Suffix V.

MODEL NO.	LIST PRICE	SUFFIX M,S	SUFFIX STN/POL	SUFFIX STN	SUFFIX T	*SUFFIX TOP	*SUFFIX V
7-200B-ASB	3,753.40	N/C	540.35	213.65	790.60	154.65	155.50
7-400B-ASB	4,138.70	N/C	835.60	213.65	790.60	154.65	171.90
7-500B-ASB	4,894.45	N/C	887.50	284.25	1,037.85	154.65	366.00
7-700B-ASB	5,122.45	N/C	887.50	284.25	1,037.85	208.80	439.90
7-900B-ASB	5,704.70	N/C	1,066.50	373.75	1,205.00	312.60	439.90
7-1000B-ASB	6,308.00	N/C	1,188.95	373.75	1,205.00	449.70	752.50

“BW” Series, Valve and Piping in Cabinet with Cold Water By-Pass

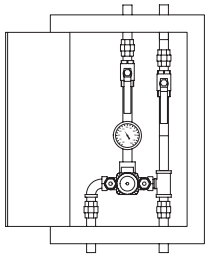

MODIFICATIONS — Add to list price and weight where applicable.

MODEL NO.	LIST PRICE	SUFFIX P	SUFFIX M	SUFFIX S	SUFFIX T	SUFFIX NI
7-200BW	4,690.45	736.50	N/C	N/C	739.20	326.95
7-400BW	5,179.20	762.45	N/C	N/C	739.20	471.30
7-500BW	6,056.20	974.95	N/C	N/C	923.30	522.95
7-700BW	6,331.25	1,021.10	N/C	N/C	923.30	572.75
7-900BW	6,839.65	1,321.55	N/C	N/C	1,232.20	656.60
7-1000BW	7,893.85	1,381.00	N/C	N/C	1,232.20	703.70

“BW” Series, Valve and Piping in Cabinet with Cold Water By-Pass (Factory assembled and tested)

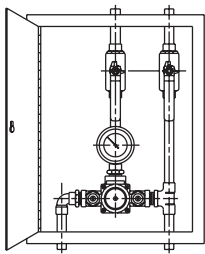

MODIFICATIONS — Add to list price and weight where applicable.

MODEL NO.	LIST PRICE	SUFFIX STN/POL	SUFFIX STN	SUFFIX M,S	SUFFIX T
7-200BW-ASB	5,194.50	692.65	213.65	N/C	785.35
7-400BW-ASB	5,838.25	835.60	213.65	N/C	785.35
7-500BW-ASB	6,515.75	887.50	284.25	N/C	1,110.45
7-700BW-ASB	7,079.15	887.50	284.25	N/C	1,110.45
7-900BW-ASB	7,194.25	1,258.00	373.75	N/C	1,315.80
7-1000BW-ASB	8,609.20	1,258.00	373.75	N/C	1,315.80

HI-LOW Systems, Valve and Piping Assembly (Factory assembled and tested)

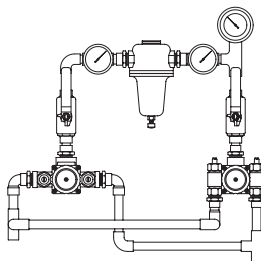

MODIFICATIONS — Add to list price and weight where applicable.

MODEL NO.	LIST PRICE	SUFFIX STN/POL	SUFFIX STN
7-200-102-PRV	6,130.25	1,094.25	320.40
7-400-102-PRV	6,873.50	1,099.50	320.40
7-500-102-PRV	7,520.50	1,261.40	373.75
7-700-102-PRV	7,842.25	1,284.75	373.75
7-900-102-PRV	7,866.05	1,324.10	427.20
7-1000-102-PRV	9,835.05	1,341.45	427.20
7-900-200-PRV	8,035.50	1,368.10	427.20
7-1000-200-PRV	10,236.70	1,467.00	427.20

HI-LOW “B” Series Systems, Valve and Piping in Cabinet (Factory assembled and tested)

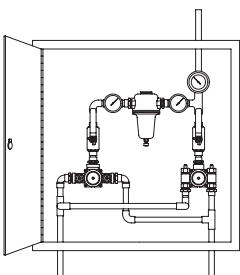

MODIFICATIONS — Add to list price and weight where applicable.

MODEL NO.	LIST PRICE	SUFFIX STN/POL	SUFFIX STN	SUFFIX M,S	SUFFIX T	SUFFIX V
7-200B-102-PRV	9,172.65	1,094.25	320.40	N/C	942.40	155.50
7-400B-102-PRV	9,948.70	1,099.50	320.40	N/C	942.40	171.90
7-500B-102-PRV	10,407.05	1,261.40	373.75	N/C	1,332.55	366.00
7-700B-102-PRV	10,501.45	1,284.85	373.75	N/C	1,332.55	439.90
7-900B-102-PRV	10,535.75	1,324.15	427.20	N/C	1,578.90	439.90
7-1000B-102-PRV	12,889.95	1,341.45	427.20	N/C	1,578.90	439.90
7-900B-200-PRV	10,991.95	1,368.10	427.20	N/C	1,578.90	752.50
7-1000B-200-PRV	13,054.70	1,467.00	427.20	N/C	1,578.90	752.50

TEMPCONTROL Unit

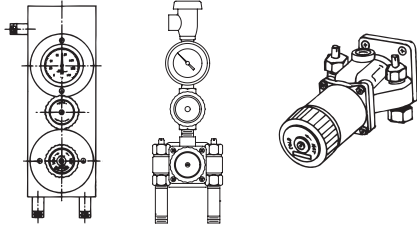

MODIFICATIONS — Add to list price and weight where applicable.

MODEL NO.	LIST PRICE
7-100	2,802.60
7-101	2,310.60
7-101P	2,704.70
7-102	1,478.85
7-102P	1,733.35

TEMPCONTROL Cartridges Only

When purchasing a TempControl valve it is recommended to purchase a spare cartridge for non-interrupted service. When ordering cartridge, designate on order all numbers on original cartridge.

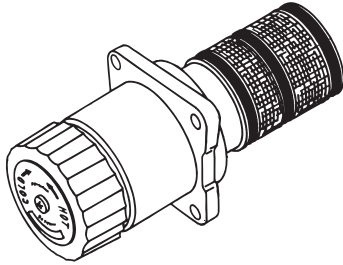

MODEL NO.	LIST PRICE
7-102NW	1,356.95
7-102P-NW	1,656.40
7-200NW	1,298.55
7-400NW	1,470.35
7-500NW	1,476.25
7-700NW	1,477.40
7-900NW	2,000.05
7-1000NW	2,000.05

TEMPCONTROL Accessories

Bimetal dial thermometer, 3" face, range 20°-240°F, horizontal 4" bulb. Complete with fittings for mounting in TempControl outlet line.

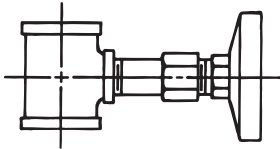

MODEL NO.	LIST PRICE
T-425-200	451.70
T-425-400	501.15
T-425-500	546.85
T-425-700	572.35
T-425-900	572.35
T-425-1000	643.35

Bimetal dial thermometer only.

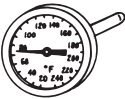



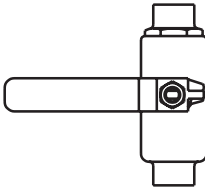

MODEL NO.	LIST PRICE
T-425-4 (4" bulb)	304.85

Volume control shut-off valves.

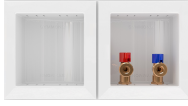

MODEL NO.	LIST PRICE
BV-200	262.05
BV-400	341.05
BV-500	464.30
BV-700/900	589.20
BV-1000	883.35

LaundryMate® Washing Machine Valves

	DESCRIPTION	MODEL	FINISH	PRICE
	<ul style="list-style-type: none"> • Washing Machine Valve • ON/OFF settings • Brass valve body • 1/2" sweat union ell connections 	W-400	Brass	102.05
				
	<ul style="list-style-type: none"> • LaundryMate Box • Hot and cold washing machine valves • Separate, color-coded handles for hot and cold shutoff • Dual-box installation system • Interlocking tab design for easy alignment • Box accommodates top or bottom supply 	LM600	N/A	83.70
	<ul style="list-style-type: none"> • LaundryMate Box • Hot and cold washing machine valves • Water hammer arrestors • Separate, color-coded handles for hot and cold shutoff • Dual-box installation system • Interlocking tab design for easy alignment • Box accommodates top or bottom supply 	LM600A	N/A	139.80
	<ul style="list-style-type: none"> • LaundryMate Box • Hot and cold washing machine valves • Separate, color-coded handles for hot and cold shutoff • Dual-box installation system • Interlocking tab design for easy alignment • Box accommodates top or bottom supply • Funnel included for condensate line 	LM600F	N/A	98.60

LaundryMate® Washing Machine Valves

DESCRIPTION	MODEL	FINISH	PRICE
<ul style="list-style-type: none"> • LaundryMate Box • Hot and cold washing machine valves • Water hammer arrestors • Separate, color-coded handles for hot and cold shutoff • Dual-box installation system • Interlocking tab design for easy alignment • Box accommodates top or bottom supply • Funnel included for condensate line 	LM600FA	N/A	154.75

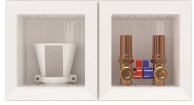

<ul style="list-style-type: none"> • IceMate Box • Cold valve with shutoff handle • Mounting box included • Side tab design allows for mounting on either side of stud bay • Box accommodates top or bottom supply 	IM600	N/A	60.55
---	-------	-----	-------



<ul style="list-style-type: none"> • IceMate Box • Cold valve with shutoff handle • Water hammer arrestor • Mounting box included • Side tab design allows for mounting on either side of stud bay • Box accommodates top or bottom supply 	IM600A	N/A	81.95
--	--------	-----	-------



Modifications for all LaundryMate Washing Machine Valves

SUFFIX	DESCRIPTION	PRICE
IPSC	Combination 1/2" MIPS or 1/2" sweat connections (W-400 and W-500 only)	N/C
IPSF	1/2" FIPS connections (W-400 and W-500 only)	15.35
P1	PEX Crimp Fitting (for LaundryMate LM600F and LM600FA only)	20.80
P2	PEX Cold Expansion Fitting (for LaundryMate LM600F and LM600FA only)	20.80
P1.	PEX Crimp Fitting (for IceMate)	10.45
P2.	PEX Cold Expansion Fitting (for IceMate)	10.45

Lavatory Faucets



From rugged heavy duty commercial grade to the widespread premium style faucets utilized in the finest hotels around the globe; Symmons lavatory faucets come in multiple configurations and styles to meet the needs of your next bathroom project or remodel.

Available in these finishes:











Various finishes by product

Lavatory Faucets

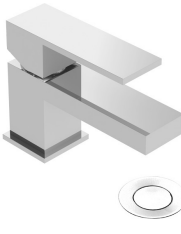
Lavatory Faucets (Single Handle)

	DESCRIPTION	MODEL	FINISH	PRICE
	<ul style="list-style-type: none"> • Birch Single Handle Lavatory Faucet • Single-hole installation • 3/8" braided hose connections • Ceramic cartridges • Metal construction • Metal push-pop drain assembly included • 1.0 gpm (3.8 L/min) flow rate 	<ul style="list-style-type: none"> SLS5912PP SLS5912STNPP 	<ul style="list-style-type: none"> Chrome Satin Nickel 	<ul style="list-style-type: none"> 330.40 429.55
	WS P ♿ LF			
	<ul style="list-style-type: none"> • Braston Single Handle Lavatory Faucet • Single-hole installation • 3/8" braided hose connections • Ceramic cartridges • Metal construction • Metal push-pop drain assembly included • 1.0 gpm (3.8 L/min) flow rate • Matte Black finish is Special Order 	<ul style="list-style-type: none"> SLS5812PP SLS5812STNPP SLS5812MBPP SLS5812BBZPP 	<ul style="list-style-type: none"> Chrome Satin Nickel Matte Black Brushed Bronze 	<ul style="list-style-type: none"> 432.40 562.05 605.35 605.35
	WS P ♿ LF			
	<ul style="list-style-type: none"> • Dia Single Handle Lavatory Faucet • Single-hole installation • 7-1/8" height • 3/8" braided hose connections • Ceramic cartridges • Metal construction • Metal push-pop drain assembly included • 1.0 gpm (3.8 L/min) flow rate 	<ul style="list-style-type: none"> SLS3512PP SLS3512STNPP SLS3512MBPP SLS3512BBZPP 	<ul style="list-style-type: none"> Chrome Satin Nickel Matte Black Brushed Bronze 	<ul style="list-style-type: none"> 380.20 489.70 551.40 551.40
	WS P ♿ LF			
	<ul style="list-style-type: none"> • Dia Single Handle Lavatory Faucet • Single-hole installation • 5" height • 3/8" braided hose connections • Ceramic cartridges • Metal construction • Metal push-pop drain assembly included • 1.0 gpm (3.8 L/min) flow rate 	<ul style="list-style-type: none"> SLS3522PP SLS3522STNPP SLS3522MBPP SLS3522BBZPP 	<ul style="list-style-type: none"> Chrome Satin Nickel Matte Black Brushed Bronze 	<ul style="list-style-type: none"> 380.20 489.70 551.40 551.40
	WS P ♿ LF			





Lavatory Faucets (Single Handle)

	DESCRIPTION	MODEL	FINISH	PRICE
	• Duro Single Handle Lavatory Faucet	SLS3612PP	Chrome	438.35
	• Single-hole installation	SLS3612STNPP	Satin Nickel	569.75
	• 6-7/8" height	SLS3612MBPP	Matte Black	635.60
	• 3/8" braided hose connections	SLS3612BBZPP	Brushed Bronze	635.60
	• Ceramic cartridges • Metal construction • Metal push-pop drain assembly included • 1.0 gpm (3.8 L/min) flow rate			
				
	• Duro Single Handle Lavatory Faucet	SLS3622PP	Chrome	438.35
	• Single-hole installation	SLS3622STNPP	Satin Nickel	569.75
	• 4-1/2" height	SLS3622MBPP	Matte Black	635.60
	• 3/8" braided hose connections	SLS3622BBZPP	Brushed Bronze	635.60
	• Ceramic cartridges • Metal construction • Metal push-pop drain assembly included • 1.0 gpm (3.8 L/min) flow rate			
				
	• Elm Single Handle Lavatory Faucet	SLS5512PP	Chrome	421.50
	• Single-hole installation	SLS5512STNPP	Satin Nickel	550.75
	• 3/8" braided hose connections	SLS5512MBPP	Matte Black	590.05
	• Ceramic cartridges	SLS5512BBZPP	Brushed Bronze	590.05
	• Metal construction • Metal push-pop drain assembly included • 1.0 gpm (3.8 L/min) flow rate			
				
	• Identity Single Handle Lavatory Faucet	SLS6712PP	Chrome	291.95
	• Single-hole installation	SLS6712STNPP	Satin Nickel	408.65
	• 3/8" braided hose connections	SLS6712MBPP	Matte Black	408.75
	• Ceramic cartridges	SLS6712BBZPP	Brushed Bronze	408.70
	• Metal construction • Metal push-pop drain assembly included • 1.0 gpm (3.8 L/min) flow rate			
				



Lavatory Faucets (Single Handle)

	DESCRIPTION	MODEL	FINISH	PRICE
	• Oak Single Handle Lavatory Faucet	SLS5612PP	Chrome	432.40
	• Single-hole installation	SLS5612STNPP	Satin Nickel	562.05
	• 3/8" braided hose connections	SLS5612MBPP	Matte Black	605.35
	• Ceramic cartridges	SLS5612BBZPP	Brushed Bronze	605.35
	• Metal construction			
	• Metal push-pop drain assembly included			
	• 1.0 gpm (3.8 L/min) flow rate			
	WS P  LF			
	• Origins Single Handle Centerset Lavatory Faucet	S9612PP	Chrome	124.30
		S9612STNPP	Satin Nickel	174.05
	• 3-hole installation with 4" center			
	• 3/8" braided hose connections			
	• Ceramic cartridges			
	• Metal construction			
	• Metal push-pop drain assembly included			
	• 1.0 gpm (3.8 L/min) flow rate			
	WS  LF			
	• Single Handle Lavatory Faucet	SLS0488PP	Chrome	492.20
	• Single-hole installation	SLS0488STNPP	Satin Nickel	639.85
	• Ceramic cartridge			
	• Braided hose connections			
	• Metal push-pop drain assembly included			
	• 1.0 gpm (3.8 L/min) standard			
	WS P  LF			
	• Symmetrix Single Handle Centerset Lavatory Faucet	S202PP	Chrome	244.55
		S202STNPP	Satin Nickel	387.80
	• 3-hole installation with 4" center			
	• Red and blue handle indicators			
	• 3/8" braided hose connections			
	• Ceramic cartridges			
	• Metal construction			
	• Metal push-pop drain assembly included			
	• 1.0 gpm (3.8 L/min) flow rate			
	WS   LF			











Lavatory Faucets (Single Handle)

	DESCRIPTION	MODEL	FINISH	PRICE
	• Symmetrix Single Handle Centerset Lavatory Faucet	S202G	Chrome	244.55
	• 3-hole installation with 4" center • Red and blue handle indicators • 3/8" braided hose connections • Ceramic cartridges • Metal construction • Metal grid drain assembly included • 1.0 gpm (3.8 L/min) flow rate	S202STNG	Satin Nickel	-
				
	• Solarity Single Handle Lavatory Faucet	SLS3312PP	Chrome	330.40
	• Single-hole installation	SLS3312STNPP	Satin Nickel	429.45
	• 3/8" braided hose connections • Ceramic cartridges • Metal construction • Metal push-pop drain assembly included • 1.0 gpm (3.8 L/min) flow rate	SLS3312MBPP	Matte Black	462.55
	• Verity Single Handle Lavatory Faucet	SLS4912PP	Chrome	330.40
	• Single-hole installation	SLS4912STNPP	Satin Nickel	429.55
	• 6-3/16" height • 3/8" braided hose connections • Ceramic cartridges • Metal construction • Metal push-pop drain assembly included • 1.0 gpm (3.8 L/min) flow rate	SLS4912MBPP	Matte Black	462.55
				





Modifications for Single Handle Lavatory Faucets

SUFFIX	DESCRIPTION	PRICE
035	 0.35 gpm (1.3 L/min) vandal resistant flow restrictor (available only for S20 series)	N/A
05	 0.5 gpm (1.9 L/min) vandal resistant flow restrictor	N/A
OFG	Offset grid strainer (S202 only)	57.70
W	6" lever handle (S20 series in chrome only)	24.10



Lavatory Faucets (Two Handle Centerset)

	DESCRIPTION	MODEL	FINISH	PRICE
	<ul style="list-style-type: none"> Allura Centerset Lavatory Faucet 3-hole installation with 4" center 1/2" IPS connections Ceramic cartridges Solid brass construction Metal push-pop drain assembly included 1.0 gpm (3.8 L/min) flow rate 	SLC4712PP	Chrome	295.40
		SLC4712STNPP	Satin Nickel	416.25
	<p>WS P  LF</p>			
	<ul style="list-style-type: none"> Birch Centerset Lavatory Faucet 3-hole installation with 4" center 1/2" IPS connections Ceramic cartridges Solid brass construction Metal push-pop drain assembly included 1.0 gpm (3.8 L/min) flow rate 	SLC5912PP	Chrome	286.55
		SLC5912STNPP	Satin Nickel	372.55
	<p>WS P  LF</p>			
	<ul style="list-style-type: none"> Dia Centerset Lavatory Faucet 3-hole installation with 4" center 1/2" IPS connections Ceramic cartridges Solid brass construction Metal push-pop drain assembly included 1.0 gpm (3.8 L/min) flow rate 	SLC3512PP	Chrome	353.30
		SLC3512STNPP	Satin Nickel	464.30
	<p>WS P  LF</p>			
	<ul style="list-style-type: none"> Duro Centerset Lavatory Faucet 3-hole installation with 4" center 1/2" IPS connections Ceramic cartridges Solid brass construction Metal push-pop drain assembly included 1.0 gpm (3.8 L/min) flow rate 	SLC3612PP	Chrome	433.80
		SLC3612STNPP	Satin Nickel	565.20
	<p>WS P  LF</p>			
	<ul style="list-style-type: none"> Elm Centerset Lavatory Faucet 3-hole installation with 4" center 1/2" IPS connections Ceramic cartridges Solid brass construction Metal push-pop drain assembly included 1.0 gpm (3.8 L/min) flow rate 	SLC5512PP	Chrome	307.25
		SLC5512STNPP	Satin Nickel	402.50
		SLC5512MBPP	Matte Black	430.20
		SLC5512BBZPP	Brushed Bronze	430.20
	<p>WS P  LF</p>			

Lavatory Faucets (Two Handle Centerset)

	DESCRIPTION	MODEL	FINISH	PRICE
	• Identity Centerset Lavatory Faucet	SLC6712PP	Chrome	252.15
	• 3-hole installation with 4" center	SLC6712STNPP	Satin Nickel	353.05
	• 1/2" IPS connections			
	• Ceramic cartridges			
	• Solid brass construction			
	• Metal push-pop drain assembly included			
	• 1.0 gpm (3.8 L/min) flow rate			
				
	• Origins Centerset Lavatory Faucet	SLC9612PP	Chrome	139.25
	• 3-hole installation with 4" center	SLC9612STNPP	Satin Nickel	195.00
	• 3/8" braided hose connections			
	• Ceramic cartridges			
	• Metal construction			
	• Metal push-pop drain assembly included			
	• 1.0 gpm (3.8 L/min) flow rate			
				

Lavatory Faucets (Two Handle Centerset)

	DESCRIPTION	MODEL	FINISH	PRICE
	<ul style="list-style-type: none"> • Symmetrix Two Handle Centerset Lavatory Faucet • 3-hole installation with 4" center • Red and blue handle indicators • 1/2" IPS connections • Ceramic cartridges • Metal construction • Metal push-pop drain assembly included • 1.0 gpm (3.8 L/min) flow rate 	S2402PP	Chrome	317.15
	<ul style="list-style-type: none"> • Symmetrix Two Handle Centerset Lavatory Faucet • 3-hole installation with 4" center • Red and blue handle indicators • 1/2" IPS connections • Ceramic cartridges • Metal construction • Metal push-pop drain assembly included • 1.0 gpm (3.8 L/min) flow rate 	S2402LAMPP	Chrome	344.50
	<ul style="list-style-type: none"> • Symmetrix Two Handle Centerset Lavatory Faucet • 3-hole installation with 4" center • Red and blue handle indicators • 1/2" IPS connections • Ceramic cartridges • Metal construction • Metal push-pop drain assembly included • 1.0 gpm (3.8 L/min) flow rate 	S2402LWGP	Chrome	344.50
	<ul style="list-style-type: none"> • Symmetrix Two Handle Centerset Lavatory Faucet • 3-hole installation with 4" center • Red and blue handle indicators • 1/2" IPS connections • Ceramic cartridges • Metal construction • Metal push-pop drain assembly included • 1.0 gpm (3.8 L/min) flow rate 	S2502PP	Chrome	294.30
	<ul style="list-style-type: none"> • Symmetrix Two Handle Centerset Lavatory Faucet • 3-hole installation with 4" center • Red and blue handle indicators • 1/2" IPS connections • Ceramic cartridges • Metal construction • Metal push-pop drain assembly included • 1.0 gpm (3.8 L/min) flow rate 	S2502PP	Chrome	294.30
	<ul style="list-style-type: none"> • Symmetrix Two Handle Centerset Lavatory Faucet • 3-hole installation with 4" center • Red and blue handle indicators • 1/2" IPS connections • Ceramic cartridges • Metal construction • Metal push-pop drain assembly included • 1.0 gpm (3.8 L/min) flow rate 			



Lavatory Faucets (Two Handle Centerset)



DESCRIPTION	MODEL	FINISH	PRICE
<ul style="list-style-type: none"> • Symmetrix Two Handle Centerset Lavatory Faucet • 3-hole installation with 4" center • Red and blue handle indicators • 1/2" IPS connections • Ceramic cartridges • Metal construction • Metal push-pop drain assembly included • 1.0 gpm (3.8 L/min) flow rate 	S2502PPLWG	Chrome	294.30

Modifications for Symmons Symmetrix S-240 Series Lavatory Faucets

SUFFIX	DESCRIPTION	PRICE
05	CC 0.5 gpm (1.9 L/min) vandal resistant flow restrictor	N/A
G	Grid drain in lieu of pop-up (S-240-2, SLC-9612 only)	N/C







Lavatory Faucets (Two Handle Widespread)

	DESCRIPTION	MODEL	FINISH	PRICE
	• Allura Widespread Lavatory Faucet	SLW4712PP	Chrome	741.20
	• 3-hole installation with 8-16" center	SLW4712STNPP	Satin Nickel	897.60
	• Threadless valve-to-spout connections			
	• 3/8" braided hose connections			
	• Ceramic cartridges			
	• Metal push-pop drain assembly included			
	• 1.0 gpm (3.8 L/min) flow rate			
	WS P  LF			
	• Birch Widespread Lavatory Faucet	SLW5912PP	Chrome	415.80
	• 3-hole installation with 8-16" center	SLW5912STNPP	Satin Nickel	540.50
	• Threadless valve-to-spout connections			
	• 3/8" braided hose connections			
	• Ceramic cartridges			
	• Metal push-pop drain assembly included			
	• 1.0 gpm (3.8 L/min) flow rate			
	WS P  LF			
	• Braston Widespread Lavatory Faucet	SLW5812PP	Chrome	657.35
	• 3-hole installation with 8-16" center	SLW5812STNPP	Satin Nickel	854.55
	• Threadless valve-to-spout connections	SLW5812MBPP	Matte Black	920.25
	• 3/8" braided hose connections	SLW5812BBZPP	Brushed Bronze	920.25
	• Ceramic cartridges			
	• Metal construction			
	• Metal push-pop drain assembly included			
	• 1.0 gpm (3.8 L/min) flow rate			
	WS P  LF			
	• Dia Widespread Lavatory Faucet	SLW3512PP	Chrome	561.85
	• 3-hole installation with 8-16" center	SLW3512STNPP	Satin Nickel	730.25
	• 7-1/4" spout height	SLW3512MBPP	Matte Black	790.85
	• Threadless valve-to-spout connections	SLW3512BBZPP	Brushed Bronze	790.85
	• 3/8" braided hose connections			
	• Ceramic cartridges			
	• Metal push-pop drain assembly included			
	• 1.0 gpm (3.8 L/min) flow rate			
	WS P  LF			









Lavatory Faucets (Two Handle Widespread)

	DESCRIPTION	MODEL	FINISH	PRICE
	• Dia Widespread Lavatory Faucet	SLW3522PP	Chrome	561.85
	• 3-hole installation with 8-16" center	SLW3522STNPP	Satin Nickel	730.25
	• 5-3/4" spout height	SLW3522MBPP	Matte Black	786.60
	• Threadless valve-to-spout connections	SLW3522BBZPP	Brushed Bronze	786.60
	• 3/8" braided hose connections			
	• Ceramic cartridges			
	• Metal push-pop drain assembly included			
	• 1.0 gpm (3.8 L/min) flow rate			
				
	• Duro Widespread Lavatory Faucet	SLW3612PP	Chrome	702.75
	• 3-hole installation with 8-16" center	SLW3612STNPP	Satin Nickel	913.50
	• 6-11/16" spout height	SLW3612MBPP	Matte Black	989.30
	• Threadless valve-to-spout connections	SLW3612BBZPP	Brushed Bronze	989.30
	• 3/8" braided hose connections			
	• Ceramic cartridges			
	• Metal push-pop drain assembly included			
	• 1.0 gpm (3.8 L/min) flow rate			
				
	• Duro Widespread Lavatory Faucet	SLW3622PP	Chrome	702.75
	• 3-hole installation with 8-16" center	SLW3622STNPP	Satin Nickel	913.50
	• 4-1/16" spout height			
	• Threadless valve-to-spout connections			
	• 3/8" braided hose connections			
	• Ceramic cartridges			
	• Metal push-pop drain assembly included			
	• 1.0 gpm (3.8 L/min) flow rate			
				
	• Elm Widespread Lavatory Faucet	SLW5512PP	Chrome	529.65
	• 3-hole installation with 8-16" center	SLW5512STNPP	Satin Nickel	694.80
	• Threadless valve-to-spout connections	SLW5512MBPP	Matte Black	741.55
	• 3/8" braided hose connections	SLW5512BBZPP	Brushed Bronze	741.55
	• Ceramic cartridges			
	• Metal push-pop drain assembly included			
	• 1.0 gpm (3.8 L/min) flow rate			
				

Lavatory Faucets (Two Handle Widespread)

	DESCRIPTION	MODEL	FINISH	PRICE
	• Identity Widespread Lavatory Faucet	SLW6712PP	Chrome	365.85
	• 3-hole installation with 8-16" center	SLW6712STNPP	Satin Nickel	512.25
	• Threadless valve-to-spout connections	SLW6712MBPP	Matte Black	512.25
	• 3/8" braided hose connections	SLW6712BBZPP	Brushed Bronze	512.20
	• Ceramic cartridges			
	• Metal push-pop drain assembly included			
	• 1.0 gpm (3.8 L/min) flow rate			
				
	• Oak Widespread Lavatory Faucet	SLW5612PP	Chrome	657.35
	• 3-hole installation with 8-16" center	SLW5612STNPP	Satin Nickel	854.60
	• Threadless valve-to-spout connections	SLW5612MBPP	Matte Black	920.40
	• 3/8" braided hose connections	SLW5612BBZPP	Brushed Bronze	920.40
	• Ceramic cartridges			
	• Metal construction			
	• Metal push-pop drain assembly included			
	• 1.0 gpm (3.8 L/min) flow rate			
				
	• Solarity Widespread Lavatory Faucet	SLW3312PP	Chrome	415.80
	• 3-hole installation with 8-16" center	SLW3312STNPP	Satin Nickel	540.50
	• Threadless valve-to-spout connections	SLW3312MBPP	Matte Black	582.10
	• 3/8" braided hose connections			
	• Ceramic cartridges			
	• Metal push-pop drain assembly included			
	• 1.0 gpm (3.8 L/min) flow rate			
				
	• Verity Widespread Lavatory Faucet	SLW4912PP	Chrome	415.80
	• 3-hole installation with 8-16" center	SLW4912STNPP	Satin Nickel	540.50
	• 5-7/16" spout height	SLW4912MBPP	Matte Black	581.90
	• Threadless valve-to-spout connections			
	• 3/8" braided hose connections			
	• Ceramic cartridges			
	• Metal push-pop drain assembly included			
	• 1.0 gpm (3.8 L/min) flow rate			





Lavatory Faucets (Two Handle Widespread)

	DESCRIPTION	MODEL	FINISH	PRICE
	<ul style="list-style-type: none"> • Origins Widespread Lavatory Faucet • 3-hole installation with 8-16" center • Threadless valve-to-spout connections • 3/8" braided hose connections • Ceramic cartridges • Metal push-pop drain assembly included • 1.0 gpm (3.8 L/min) flow rate 	S2442LAMPP S2442STNLAMPP	Chrome Satin Nickel	491.45 692.00
				
	<ul style="list-style-type: none"> • Origins Widespread Lavatory Faucet • 3-hole installation with 8-16" center • Threadless valve-to-spout connections • 3/8" braided hose connections • Ceramic cartridges • Metal push-pop drain assembly included • 1.0 gpm (3.8 L/min) flow rate 	S2442LWGPP S2442STNLWGPP	Chrome Satin Nickel	491.45 692.00
				
	<ul style="list-style-type: none"> • Origins Widespread Lavatory Faucet • 3-hole installation with 8-16" center • Threadless valve-to-spout connections • 3/8" braided hose connections • Ceramic cartridges • Drain assembly not included • 1.0 gpm (3.8 L/min) flow rate 	S2440LAM S2440STNLAM	Chrome Satin Nickel	454.05 543.35
				
	<ul style="list-style-type: none"> • Origins Widespread Lavatory Faucet • 3-hole installation with 8-16" center • Threadless valve-to-spout connections • 3/8" braided hose connections • Ceramic cartridges • Drain assembly not included • 1.0 gpm (3.8 L/min) flow rate 	S2440LWG S2440STNLWG	Chrome Satin Nickel	454.05 543.35
				
	<ul style="list-style-type: none"> • Origins Widespread Lavatory Faucet • 3-hole installation with 8-16" center • 11-11/16" rigid/swivel spout • Drain assembly not included • 1.0 gpm (3.8 L/min) flow rate 	S254LWG	Chrome	527.75

Modifications for Origins Widespread Lavatory Faucets

SUFFIX	DESCRIPTION	PRICE
G	Grid drain in place of pop-up drain (S-244-2 only)	N/C

Lavatory Faucets (Wall-Mounted)

	DESCRIPTION	MODEL	FINISH	PRICE
	• Two Handle Wall-Mounted Lavatory Faucet	SWM4310	Chrome	1248.00
	• 1.0 gpm (3.8 L/min) flow rate	SWM4310STN	Satin Nickel	1601.30
				
	• Single Handle Wall-Mounted Lavatory Faucet	SWM0153270005	Chrome	516.00
	• Ceramic cartridge • 0.5 gpm (1.9 L/min) standard			
				

Modifications for Wall Mount Lavatory Faucets

SUFFIX	DESCRIPTION	CHROME	STN	BBZ	MB
05	 0.5 gpm (1.9 L/min) flow restrictor	N/A	N/A	N/A	N/A

Tub Faucets



DESCRIPTION	MODEL	FINISH	PRICE
	<i>If tempering valve is required, use MaxLine® 7-230 Series (page 208)</i>		
• Braston Freestanding Tub Filler	FSTF5872	Chrome	2269.10
• Floor-mounted tub filler with single-handle temperature control	FSTF5872STN	Satin Nickel	2949.85
• 4" HydroMersion hand shower wand with 7 modes	FSTF5872MB	Matte Black	3176.70
	FSTF5872BBZ	Brushed Bronze	3176.70
• EverFlow rubber spray nozzles			
• 60" flexible metal hose			
• Metal lever handle			
• 2.0 gpm (7.6 L/min) flow rate hand shower			
• 5.3 gpm (20.1 L/min) at 45 psi tub filler			
• Matte Black finish is Special Order			



	<i>If tempering valve is required, use MaxLine® 7-230 Series (page 208)</i>		
• Dia Freestanding Tub Filler	FSTF357220	Chrome	1996.75
• Floor-mounted tub filler with single-handle temperature control	FSTF357220STN	Satin Nickel	2595.85
• Single-function hand shower wand	FSTF357220MB	Matte Black	2795.50
• 60" flexible metal hose	FSTF357220BBZ	Brushed Bronze	2795.50
• Metal lever handle			
• 2.0 gpm (7.6 L/min) flow rate hand shower			
• 5.3 gpm (20.1 L/min) at 45 psi tub filler			



	<i>If tempering valve is required, use MaxLine® 7-230 Series (page 208)</i>		
• Duro Freestanding Tub Filler	FSTF367220	Chrome	2196.45
• Floor-mounted tub filler with single-handle temperature control	FSTF367220STN	Satin Nickel	2854.70
• Single-function hand shower wand	FSTF367220MB	Matte Black	3075.10
• 60" flexible metal hose	FSTF367220BBZ	Brushed Bronze	3075.10
• Metal lever handle			
• 2.0 gpm (7.6 L/min) flow rate hand shower			
• 5.3 gpm (20.1 L/min) at 45 psi tub filler			



• Elm Two Handle Roman Tub Faucet	SRT-5570	Chrome	773.00
• Ceramic cartridges	SRT-5570-STN	Satin Nickel	1006.30
• 1/2" rigid copper connections			
• Cast brass spout			
• Hand spray not included			



Tub Faucets



DESCRIPTION	MODEL	FINISH	PRICE
	<i>If tempering valve is required, use MaxLine® 7-230 Series (page 208)</i>		
• Oak Freestanding Tub Filler	FSTF5672	Chrome	2269.10
• Floor-mounted tub filler with single-handle temperature control	FSTF5672STN	Satin Nickel	2949.85
• 4" HydroMersion hand shower wand with Total spray and push-button Pause mode	FSTF5672MB	Matte Black	3176.70
• EverFlow rubber spray nozzles	FSTF5672BBZ	Brushed Bronze	3176.70
• 60" flexible metal hose			
• Metal lever handle			
• 2.0 gpm (7.6 L/min) flow rate hand shower			
• 5.3 gpm (20.1 L/min) at 45 psi tub filler			



Modifications for Tub Fillers

SUFFIX	DESCRIPTION	CHROME	STN	BBZ	MB
15	 1.5 gpm (5.7 L/min) flow restrictor	N/A	N/A	N/A	N/A

Kitchen Faucets













Symmons Kitchen Faucets bring together superior functionality and durability with a variety of style options. From traditional to contemporary, our faucets complement any décor and coordinate with our bathroom products for a cohesive look throughout your property.

Available in these finishes:



Various finishes by product

Kitchen Faucets with Pull-Out Spray

	DESCRIPTION	MODEL	FINISH	PRICE
	• Dia Pull-Down Spring Kitchen Faucet	SPR3510PD	Chrome	826.70
	• Pull-down spray wand	SPR3510PDSTS	Stainless Steel	1128.05
	• Single-hole mount	SPR3510PDMB	Matte Black	1157.40
	• Ceramic cartridge			
	• Braided hose connections			
	• 1.5 gpm (5.7 L/min) standard			
				
	• Dia Pull-Down Kitchen Faucet	SK3510PD	Chrome	532.90
	• Single-hole mount	SK3510STSPD	Stainless Steel	666.20
	• Pull-down wand with two-mode spray-to-stream control	SK3510MBPD	Matte Black	772.75
	• Braided hose connections	SK3510BBZPD	Brushed Bronze	772.75
	• 1.5 gpm (5.7 L/min) flow rate			
				
	• Identity Single Handle Kitchen Faucet	SK6710PD	Chrome	432.80
	• Single-hole mount	SK6710PDSTS	Stainless Steel	562.65
	• Ceramic cartridge			
	• Braided hose connections			
	• Pull-down wand with 2-mode spray-to-stream control			
	• Push-button spray selection			
	• 360° swivel spout			
	• 1.5 gpm (5.7 L/min) standard			
				
	• Single Handle Pull-Down Kitchen Faucet	SK2302PD	Chrome	532.90
	• Single-hole mount	SK2302STSPD	Stainless Steel	666.20
	• Ceramic cartridge	SK2302MBPD	Matte Black	772.75
	• Braided hose connections	SK2302BBZPD	Brushed Bronze	772.75
	• 2-function pull-down spout			
	• Rotating spray selection			
	• 360° swivel spout			
	• 1.5 gpm (5.7 L/min) standard			
				
	• Duro Pull-Out Kitchen Faucet	SK3610PO	Chrome	604.90
	• Single-hole mount	SK3610STSPO	Stainless Steel	846.80
	• Ceramic cartridge	SK3610MBPO	Matte Black	846.80
	• Braided hose connections	SK3610BBZPO	Brushed Bronze	846.80
	• Pull-out spray spout			
	• 1.5 gpm (5.7 L/min) standard			
				







Kitchen Faucets with Pull-Out Spray









DESCRIPTION	MODEL	FINISH	PRICE
• Unity Single Handle Kitchen Faucet	SK6600PO	Chrome	306.95
• 8" mount	SK6600STSP0	Stainless Steel	429.85
• Ceramic cartridge			
• Stainless steel braided hoses with 3/8" compression connections			
• Pull-out spray spout			
• Spray to stream touch control			
• 90° swivel spout			
• 1.5 gpm (5.7 L/min) standard			









Kitchen Faucets (Single Handle)



	DESCRIPTION	MODEL	FINISH	PRICE
	<ul style="list-style-type: none"> • Dia Single Handle Kitchen Faucet • Single-hole mount configuration • 8-3/8" swivel spout • Braided hose connections • 1.5 gpm (5.7 L/min) flow rate 	SK2660	Chrome	543.35
				
	<ul style="list-style-type: none"> • Origins Single Handle Kitchen Faucet • 8-5/8" swivel spout • Separate hand spray mounted within deck plate • Braided hose connections • 8" deck plate included • 1.5 gpm (5.7 L/min) flow rate 	SK233	Chrome	377.65
				
	• Origins Single Handle Kitchen Faucet	SK232	Chrome	328.25
	• 8-5/8" swivel spout	SK232STN	Satin Nickel	450.75
	<ul style="list-style-type: none"> • Separate hand spray • Braided hose connections • 8" deck plate included • 1.5 gpm (5.7 L/min) flow rate 			
				
	<ul style="list-style-type: none"> • Origins Single Handle Kitchen Faucet • 8-5/8" swivel spout • Ceramic cartridge • Braided hose supply lines • 360° swivel spout head • 8" deck plate included • 1.5 gpm (5.7 L/min) flow rate 	SK231	Chrome	323.05
				
	• Origins Single Handle Kitchen Faucet	SK23	Chrome	269.05
	• 8-5/8" swivel spout	SK23STN	Satin Nickel	342.05
	<ul style="list-style-type: none"> • Braided hose connections • 8" deck plate included • 1.5 gpm (5.7 L/min) flow rate 			
				

Kitchen Faucets (Two Handle)



	DESCRIPTION	MODEL	FINISH	PRICE
	<ul style="list-style-type: none"> • Origins Kitchen Faucet • 8-5/8" swivel spout • Braided hose connections • 8" deck plate included • 1.5 gpm (5.7 L/min) flow rate 	SK248	Chrome	283.75
				
	<ul style="list-style-type: none"> • Origins Kitchen Faucet • 8-5/8" swivel spout • Braided hose connections • 8" deck plate included • 1.5 gpm (5.7 L/min) flow rate 	SK248LAM	Chrome	311.05
				
	<ul style="list-style-type: none"> • Origins Kitchen Faucet • 8-5/8" swivel spout • Braided hose connections • 8" deck plate included • 1.5 gpm (5.7 L/min) flow rate 	SK248LWG	Chrome	311.05
				

Bar Sink Faucets



	DESCRIPTION	MODEL	FINISH	PRICE
	• Dia Single Handle Bar Faucet	SPB3510	Chrome	429.70
	• Single-hole mount	SPB3510STN	Satin Nickel	558.55
	• Ceramic cartridge	SPB3510MB	Matte Black	601.55
	• Braided hose connections	SPB3510BBZ	Brushed Bronze	601.55
	• Standard swivel spout with option of rigid			
	• 1.5 gpm (5.7 L/min) standard			
				
	• Symmetrix Two Handle Bar Sink Faucet	SPB245LWG	Chrome	358.45
	• 3-hole installation with 4" center	SPB245STNLWG	Satin Nickel	411.50
	• Red and blue handle indicators			
	• 3-1/2x 9-1/8" rigid/swivel spout			
	• 1/2" IPS connections			
	• Ceramic cartridges			
	• Metal construction			
	• 1.5 gpm (5.7 L/min) flow rate			
				
	• Symmetrix Two Handle Bar Sink Faucet	SPB2455LWG	Chrome	389.65
	• 3-hole installation with 4" center	SPB2455STNLWG	Satin Nickel	484.50
	• Red and blue handle indicators			
	• 5-1/2x 12-3/8" rigid/swivel spout			
	• 1/2" IPS connections			
	• Ceramic cartridges			
	• Metal construction			
	• 1.5 gpm (5.7 L/min) flow rate			
				

Modifications for all Bar Sink Faucets		
SUFFIX	DESCRIPTION	PRICE
05	 (1.9 L/min) flow restrictor (S-245 series only)	N/A
10	 1.0 gpm (3.8 L/min) flow restrictor (S-245 series only)	N/A

Service Sink Faucets

	DESCRIPTION	MODEL	FINISH	PRICE
	<ul style="list-style-type: none"> • Symmetrix Two Handle Service Sink Faucet • Wall mount • Ceramic cartridges • 1/2" IPS inlet connections • Vandal resistant • Mop bucket hook on spout 	S-2490	Rough Chrome	258.60
	<ul style="list-style-type: none"> • Symmetrix Two Handle Service Sink Faucet • Wall mount • Integral check valves • Ceramic cartridges • 1/2" IPS inlet connections • Vandal resistant • Mop bucket hook on spout 	S-2490-CHKS	Rough Chrome	283.05
	<ul style="list-style-type: none"> • Symmetrix Two Handle Laundry Faucet • 3-hole installation with 4" center • Red and blue handle indicators • 7-5/8" x 7" inch swivel spout • 1/2" IPS connections • Hose thread connection on spout • Ceramic cartridges • Metal construction • 1.5 gpm (5.7 L/min) flow rate 	S-249	Chrome	190.80

Modifications for Service Sink Faucets

SUFFIX	DESCRIPTION	PRICE
0.5	 0.5 gpm (1.9 L/min) flow restrictor	N/C
1.0	 1.0 gpm (3.8 L/min) flow restrictor	N/C

Accessories

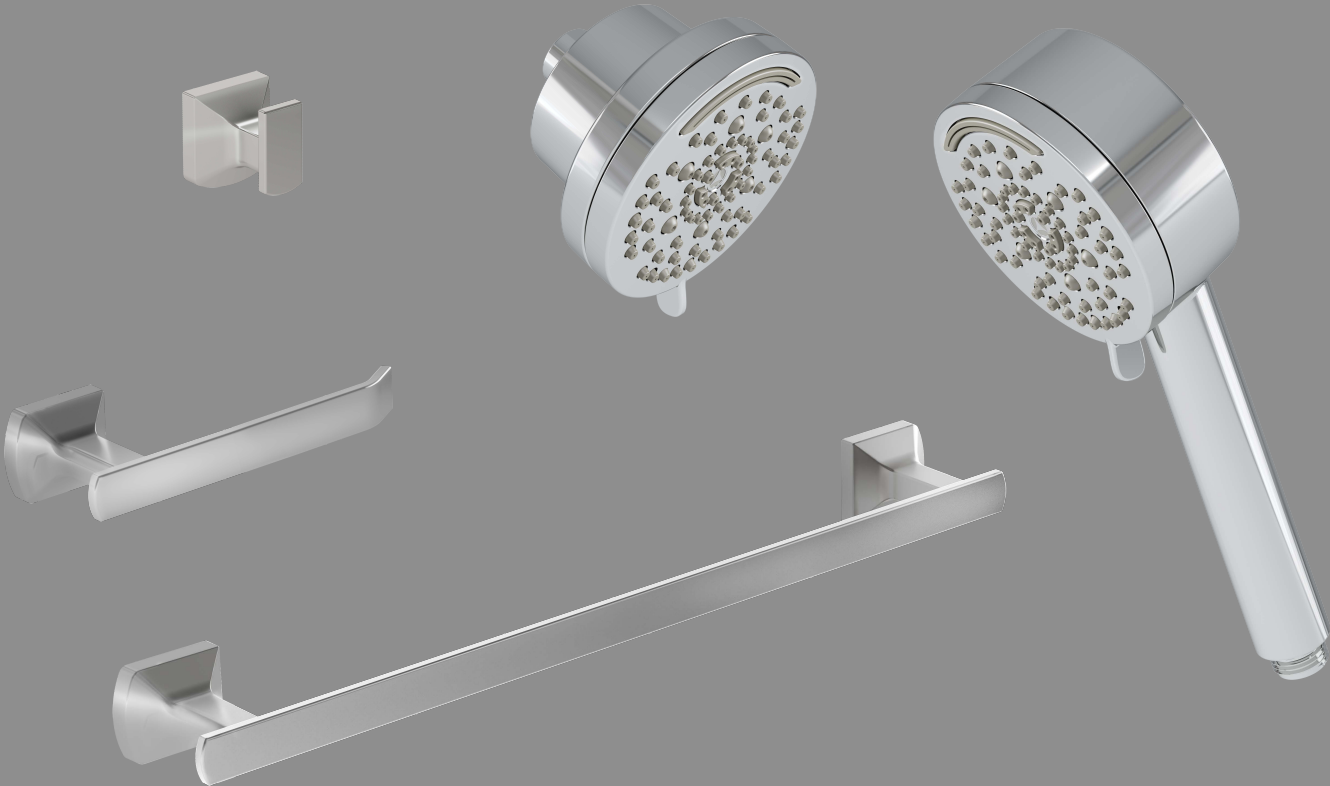





Symmons offers a full selection of accessories including showerheads, hand showers, diverters, towel bars and more. Symmons accessories are available for a wide variety of residential, commercial and institutional applications.

Available in these finishes:







Various finishes by product

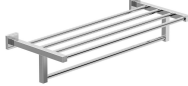

Bath Accessories Towel Bars

	DESCRIPTION	MODEL	FINISH	PRICE
	<ul style="list-style-type: none"> • 18" or 24" Towel Bar • Coordinates with Allura and Braston collections • Durable mounting system • Metal construction 	<i>18" Length</i>		
		583TB18	Chrome	100.45
		583TB18STN	Satin Nickel	130.55
		583TB18MB	Matte Black	140.60
		583TB18BBZ	Brushed Bronze	140.60
		<i>24" Length</i>		
		583TB24	Chrome	110.20
		583TB24STN	Satin Nickel	143.15
		583TB24MB	Matte Black	154.15
		583TB24BBZ	Brushed Bronze	154.15
	<ul style="list-style-type: none"> • 18" or 24" Towel Bar • Coordinates with Dia and Identity collections • Metal construction • Durable mounting system 	<i>18" Length</i>		
		353TB-18	Chrome	87.65
		353TB-18-STN	Satin Nickel	113.70
		353TB-18-MB	Matte Black	123.30
		353TB-18-BBZ	Brushed Bronze	123.30
		<i>24" Length</i>		
		353TB-24	Chrome	96.10
		353TB-24-STN	Satin Nickel	125.00
		353TB-24-MB	Matte Black	135.25
		353TB-24-BBZ	Brushed Bronze	135.25
	<ul style="list-style-type: none"> • 18" or 24" Double Towel Bar • Coordinates with Dia and Identity collections • Metal construction • Durable mounting system 	<i>18" Length</i>		
		353DTB-18	Chrome	154.80
		353DTB-18-STN	Satin Nickel	201.15
		<i>24" Length</i>		
		353DTB-24	Chrome	164.30
		353DTB-24-STN	Satin Nickel	213.45
	<ul style="list-style-type: none"> • 18" or 24" Towel Bar with Assist Bar • Coordinates with Dia and Identity collections • Stainless-steel construction • Durable mounting system • ADA compliant 	<i>18" Length</i>		
		353GBTB-18	Chrome	181.00
		353GBTB-18-STN	Satin Nickel	253.60
		<i>24" Length</i>		
		353GBTB-24	Chrome	201.15
		353GBTB-24-STN	Satin Nickel	281.60
	<ul style="list-style-type: none"> • 22" Towel Shelf with Bar • Coordinates with Dia and Identity collections • Metal construction • Durable mounting system 	353TS-22	Chrome	315.70
		353TS-22-STN	Satin Nickel	410.45
		<i>24" Length</i>		
		353TS-24	Chrome	315.70







Bath Accessories Towel Bars

	DESCRIPTION	MODEL	FINISH	PRICE
	<ul style="list-style-type: none"> • 18" or 24" Towel Bar • Coordinates with the Duro collection • Durable mounting system • Metal construction 	<i>18" Length</i>		
		363TB-18	Chrome	121.45
		363TB-18-STN	Satin Nickel	157.90
		363TB-18-MB	Matte Black	171.00
		363TB-18-BBZ	Brushed Bronze	171.00
		<i>24" Length</i>		
		363TB-24	Chrome	140.60
		363TB-24-STN	Satin Nickel	182.80
		363TB-24-MB	Matte Black	197.85
		363TB-24-BBZ	Brushed Bronze	197.85
P				
	<ul style="list-style-type: none"> • 18" or 24" Double Towel Bar • Coordinates with the Duro collection • Durable mounting system • Metal construction 	<i>18" Length</i>		
		363DTB-18	Chrome	160.95
		363DTB-18-STN	Satin Nickel	209.15
		<i>24" Length</i>		
		363DTB-24	Chrome	188.45
		363DTB-24-STN	Satin Nickel	245.00
P				
	<ul style="list-style-type: none"> • 18" or 24" Towel Bar with Assist Bar • Coordinates with the Duro collection • Durable mounting system • Metal construction • Screwless flanges • ADA compliant 	<i>18" Length</i>		
		363GBTB-18	Chrome	181.00
		363GBTB-18-STN	Satin Nickel	253.60
		<i>24" Length</i>		
		363GBTB-24	Chrome	201.15
		363GBTB-24-STN	Satin Nickel	281.60
P				
	<ul style="list-style-type: none"> • 22" towel shelf with bar • Coordinates with the Duro collection • Durable mounting system • Metal construction 	363TS-22	Chrome	409.05
		363TS-22-STN	Satin Nickel	531.85
		P		
	<ul style="list-style-type: none"> • 18" or 24" Towel Bar • Coordinates with Birch and Elm collections • Durable mounting system • Metal construction 	<i>18" Length</i>		
		553TB-18	Chrome	86.70
		553TB-18-STN	Satin Nickel	125.55
		553TB18MB	Matte Black	121.40
		553TB18BBZ	Brushed Bronze	121.40
		<i>24" Length</i>		
		553TB-24	Chrome	95.20
		553TB-24-STN	Satin Nickel	137.90
		553TB24MB	Matte Black	133.20
		553TB24BBZ	Brushed Bronze	133.20
P				

Bath Accessories Towel Bars

	DESCRIPTION	MODEL	FINISH	PRICE
	<ul style="list-style-type: none"> • 18" or 24" Towel Bar • Coordinates with the Identity collection • Durable mounting system • Metal construction 	<i>18" Length</i>		
		673TB-18	Chrome	44.70
		673TB-STN-18	Satin Nickel	62.45
		<i>24" Length</i>		
		673TB-24	Chrome	52.55
		673TB-STN-24	Satin Nickel	73.50
	<ul style="list-style-type: none"> • 18" or 24" Towel Bar • Coordinates with Oak collection • Durable mounting system • Metal construction 	<i>18" Length</i>		
		563TB18	Chrome	100.45
		563TB18STN	Satin Nickel	130.55
		563TB18MB	Matte Black	140.60
		563TB18BBZ	Brushed Bronze	140.60
		<i>24" Length</i>		
		563TB24	Chrome	110.20
		563TB24STN	Satin Nickel	143.15
		563TB24MB	Matte Black	154.15
		563TB24BBZ	Brushed Bronze	154.15
	<ul style="list-style-type: none"> • 18" or 24" Towel Bar • Coordinates with the Verity collection • Durable mounting system • Metal construction 	<i>18" Length</i>		
		493TB18	Chrome	107.30
		493TB18STN	Satin Nickel	139.40
		493TB18MB	Matte Black	150.20
		<i>24" Length</i>		
		493TB24	Chrome	122.55
		493TB24STN	Satin Nickel	159.35
		493TB24MB	Matte Black	171.60

Bath Accessories Towel Rings

	DESCRIPTION	MODEL	FINISH	PRICE
	• Towel Ring	583TR	Chrome	63.95
	• Coordinates with Allura and Braston collections	583TRSTN	Satin Nickel	83.25
	• Durable mounting system	583TRMB	Matte Black	89.55
	• Metal construction	583TRBBZ	Brushed Bronze	89.55
	P			
	• Towel Ring	353TR	Chrome	55.75
	• Coordinates with Dia and Identity collections	353TR-STN	Satin Nickel	72.40
	• Durable mounting system	353TR-MB	Matte Black	83.80
	• Metal construction	353TR-BBZ	Brushed Bronze	83.80
	P			
	• Towel Holder	363TR	Chrome	122.25
	• Coordinates with the Duro collection	363TR-STN	Satin Nickel	158.90
	• Durable mounting system	363TR-MB	Matte Black	172.20
	• Metal construction	363TR-BBZ	Brushed Bronze	172.20
	P			
	• Towel Ring	553TR	Chrome	57.95
	• Coordinates with Birch and Elm collections	553TR-STN	Satin Nickel	84.05
	• Durable mounting system	553TRMB	Matte Black	81.20
	• Metal construction	553TRBBZ	Brushed Bronze	81.20
	P			
	• Towel Ring	673TR	Chrome	44.70
	• Coordinates with the Identity collection	673TR-STN	Satin Nickel	62.45
	P			
	• Towel Ring	563TR	Chrome	63.95
	• Coordinates with Oak collection	563TRSTN	Satin Nickel	83.25
	• Durable mounting system	563TRMB	Matte Black	89.55
	• Metal construction	563TRBBZ	Brushed Bronze	89.55
	P			



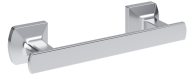



Bath Accessories Towel Rings



DESCRIPTION	MODEL	FINISH	PRICE
• Towel Holder	493TR	Chrome	50.55
• Coordinates with the Verity collection	493TRSTN	Satin Nickel	65.70
• Durable mounting system	493TRMB	Matte Black	70.85
• Metal construction			



Bath Accessories Toilet Paper Holders

	DESCRIPTION	MODEL	FINISH	PRICE
	• Toilet Paper Holder	583TP	Chrome	61.65
	• Coordinates with Allura and Braston collections	583TPSTN	Satin Nickel	80.20
		583TPMB	Matte Black	86.35
	• Durable mounting system	583TPBBZ	Brushed Bronze	86.35
	• Metal construction			
	P			
	• Toilet Paper Holder	353TP	Chrome	53.65
	• Coordinates with Dia and Identity collections	353TP-STN	Satin Nickel	69.80
		353TP-MB	Matte Black	79.95
	• Durable mounting system	353TP-BBZ	Brushed Bronze	79.95
	• Metal construction			
	P			
	• Toilet Paper Holder with Cover	353TPC	Chrome	84.55
	• Coordinates with Dia and Identity collections	353TPC-STN	Satin Nickel	109.80
	• Durable mounting system			
	• Metal construction			
	P			
	• Toilet Paper Holder	0323-3TP	Chrome	199.25
	• Coordinates with Dia and Identity collections			
	• Durable mounting system			
	• Metal construction			
	• Mounts vertical or horizontal			
	P			
	• Toilet Paper Holder with Assist Bar	353GBTP	Chrome	182.90
	• Coordinates with Dia and Identity collections	353GBTP-STN	Satin Nickel	255.95
	• Durable mounting system			
	• Stainless-steel construction			
	• ADA compliant			
	P 			
	• Toilet Paper Holder	363TP	Chrome	69.25
	• Coordinates with the Duro collection	363TP-STN	Satin Nickel	89.95
	• Durable mounting system	363TP-MB	Matte Black	97.50
	• Metal construction	363TP-BBZ	Brushed Bronze	97.50
	P			

Bath Accessories Toilet Paper Holders





	DESCRIPTION	MODEL	FINISH	PRICE
	<ul style="list-style-type: none"> • Toilet Paper Holder • Coordinates with the Duro collection • Durable mounting system • Metal construction 	0113-TP	Chrome	106.05
	P			
	<ul style="list-style-type: none"> • Toilet Paper Holder with Assist Bar • Coordinates with the Duro collection • Durable mounting system • Metal construction • Screwless flanges • ADA compliant 	363GBTP	Chrome	182.90
	P 	363GBTP-STN	Satin Nickel	255.95
	<ul style="list-style-type: none"> • Toilet Paper Holder • Coordinates with Birch and Elm collections • Durable mounting system • Metal construction 	553TP	Chrome	95.20
		553TP-STN	Satin Nickel	137.90
		553TPMB	Matte Black	133.20
		553TPBBZ	Brushed Bronze	133.20
P				
	<ul style="list-style-type: none"> • Toilet Paper Holder • Coordinates with the Identity collection • Durable mounting system • Metal construction 	673TP	Chrome	49.45
		673TP-STN	Satin Nickel	69.25
P				
	<ul style="list-style-type: none"> • Toilet Paper Holder • Coordinates with Oak collection • Durable mounting system • Metal construction 	563TP	Chrome	61.65
		563TPSTN	Satin Nickel	80.20
		563TPMB	Matte Black	86.35
		563TPBBZ	Brushed Bronze	86.35
P				
	<ul style="list-style-type: none"> • Toilet Paper Holder • Coordinates with the Verity collection • Durable mounting system • Metal construction 	493TP	Chrome	56.10
		493TPSTN	Matte Black	73.00
		493TPMB	Brushed Bronze	78.60
P				

Bath Accessories Toilet Paper Holders



DESCRIPTION	MODEL	FINISH	PRICE
• Toilet Paper Holder	229-TP	Chrome	66.70
• Metal construction	229-TP-MB	Matte Black	100.45
• Durable mounting system			

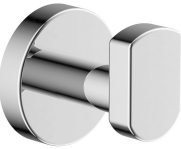

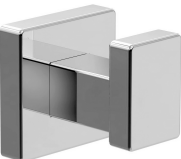
Bath Accessories Robe Hooks



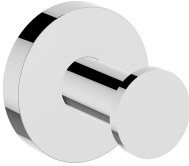



	DESCRIPTION	MODEL	FINISH	PRICE
	• Robe Hook	583RH	Chrome	32.50
	• Coordinates with Allura and Braston collections	583RHSTN	Satin Nickel	42.25
		583RHMB	Matte Black	45.50
	• Durable mounting system • Metal construction	583RHBBZ	Brushed Bronze	45.50
P				
	• Double Robe Hook	583DRH	Chrome	84.25
	• Coordinates with Allura and Braston collections	583DRHSTN	Satin Nickel	109.60
		583DRHMB	Matte Black	118.00
	• Durable mounting system • Metal construction • Matte Black finish is Special Order	583DRHBBZ	Brushed Bronze	118.00
P				
	• Robe Hook	0142-353GMRH	Chrome	128.05
	• Coordinates with Dia and Identity collections			
	• Metal construction • Glass mount installation only			
P				
	• Robe Hook	353RH	Chrome	28.20
	• Coordinates with Dia and Identity collections	353RH-STN	Satin Nickel	36.65
		353RH-MB	Matte Black	40.80
	• Durable mounting system • Metal construction	353RH-BBZ	Brushed Bronze	40.80
P				
	• Double Robe Hook	353DRH	Chrome	30.95
	• Coordinates with Dia and Identity collections	353DRH-STN	Satin Nickel	40.20
		353DRH-MB	Matte Black	43.60
	• Durable mounting system • Metal construction	353DRH-BBZ	Brushed Bronze	43.60
P				
	• Robe Hook	363RH	Chrome	36.65
	• Coordinates with the Duro collection	363RH-STN	Satin Nickel	47.65
	• Durable mounting system	363RH-MB	Matte Black	51.60
	• Metal construction	363RH-BBZ	Brushed Bronze	51.60
P				

Bath Accessories Robe Hooks

	DESCRIPTION	MODEL	FINISH	PRICE
	• Double Robe Hook	553RH	Chrome	46.40
	• Coordinates with Birch and Elm collections	553RH-STN	Satin Nickel	67.05
		553RHMB	Matte Black	64.95
	• Durable mounting system	553RHBBZ	Brushed Bronze	64.95
	• Metal construction			
	P			
	• Robe Hook	673RH	Chrome	24.85
	• Coordinates with the Identity collection	673RH-STN	Satin Nickel	34.70
	• Durable mounting system			
	• Metal construction			
	P			
	• Robe Hook	563RH	Chrome	32.50
	• Coordinates with the Oak collection	563RHSTN	Satin Nickel	42.25
	• Durable mounting system	563RHMB	Matte Black	45.50
	• Metal construction	563RHBBZ	Brushed Bronze	45.50
	P			
	• Robe Hook	493RH	Chrome	28.25
	• Coordinates with the Verity collection	493RHSTN	Satin Nickel	36.75
	• Durable mounting system	493RHMB	Matte Black	39.45
	• Metal construction			
	P			

Bath Accessories Miscellaneous

Accessories

	DESCRIPTION	MODEL	FINISH	PRICE
	• Soap Dish	353SD	Chrome	90.60
	• Metal construction	353SD-STN	Satin Nickel	117.80
	• Curved Shower Rod	353SR-5	5' Chrome	121.00
	• Contemporary/Modern style	353SR-5-STN	5' Satin Nickel	178.10
	• Metal construction	353SR-6	6' Chrome	139.30
		353SR-6-STN	6' Satin Nickel	207.75
	• 14" Glass Shelf	1003-GSH-14	Chrome	130.95
	• Metal and tempered glass construction			
	• Corner Soap Basket	1003-SB	Chrome	115.65
	• Metal construction			
	• Corner Soap Basket	363-SD2	Chrome	176.25
	• Durable mounting system • Metal construction			
	• Soap Dish	0368-3SD	Chrome	165.25
	• Attaches to hand shower unit • Metal construction • For use with 0368-2HSB-LHS only			

Bath Accessories Miscellaneous

DESCRIPTION	MODEL	FINISH	PRICE
<ul style="list-style-type: none">• Hair Dryer Holder• Metal construction	0368-3HDH	Chrome	189.60



Showerheads (Ball Joint Type)



DESCRIPTION	MODEL	FINISH	PRICE
	<i>2.0 gpm (7.6 L/min) standard</i>		
• Single-Function Showerhead	482SH	Chrome	74.05
• Standard on the Identity collection	482SHSTN	Satin Nickel	96.30
• 4" diameter	482SHMB	Matte Black	103.60
• HydroMersion technology for increased force	482SHBBZ	Brushed Bronze	103.60
	<i>1.5 gpm (5.7 L/min) WaterSense®, CALGreen</i>		
• Total spray for complete coverage	482SH15	Chrome	74.05
• EverFlow rubber spray nozzles	482SHSTN15	Satin Nickel	96.30
• Solid brass ball joint	482SHMB15	Matte Black	103.60
• Contemporary/Modern style	482SHBBZ15	Brushed Bronze	103.60



	<i>2.0 gpm (7.6 L/min) standard</i>		
• Multifunction Showerhead	482SH7	Chrome	109.05
• Standard on the Dia collection	482SH7STN	Satin Nickel	141.80
• 4" diameter	482SH7MB	Matte Black	153.70
• 7 modes	482SH7BBZ	Brushed Bronze	153.70
• HydroMersion technology for increased force			
	<i>1.5 gpm (5.7 L/min) WaterSense®, CALGreen</i>		
• EverFlow rubber spray nozzles	482SH715	Chrome	109.05
• Easy-shift thumb lever	482SH7STN15	Satin Nickel	141.80
• Solid brass ball joint	482SH7MB15	Matte Black	153.70
• Contemporary/Modern style	482SH7BBZ15	Brushed Bronze	153.70



	<i>2.0 gpm (7.6 L/min) standard</i>		
• Single-Function Showerhead	682SH	Chrome	157.25
• 6" diameter	682SHSTN	Satin Nickel	204.35
• HydroMersion technology for increased force	682SHMB	Matte Black	220.10
• Total spray for complete coverage	682SHBBZ	Brushed Bronze	220.10
	<i>1.5 gpm (5.7 L/min) WaterSense®, CALGreen</i>		
• EverFlow rubber spray nozzles	682SH15	Chrome	157.25
• Solid brass ball joint	682SHSTN15	Satin Nickel	204.35
• Contemporary/Modern style	682SHMB15	Matte Black	220.10
	682SHBBZ15	Brushed Bronze	220.10



	<i>2.0 gpm (7.6 L/min) standard</i>		
• Multifunction Showerhead	682SH7	Chrome	234.65
• 6" diameter	682SH7STN	Satin Nickel	305.10
• 7 modes	682SH7MB	Matte Black	328.50
• HydroMersion technology for increased force	682SH7BBZ	Brushed Bronze	328.50
	<i>1.5 gpm (5.7 L/min) WaterSense®, CALGreen</i>		
• EverFlow rubber spray nozzles	682SH715	Chrome	234.65
• Solid brass ball joint	682SH7STN15	Satin Nickel	305.10
• Contemporary/Modern style	682SH7MB15	Matte Black	328.50
	682SH7BBZ15	Brushed Bronze	328.50



Showerheads (Ball Joint Type)



- DESCRIPTION**
- Single-Function Showerhead
 - Standard on the Duro collection
 - 5" square
 - HydroMersion technology for increased force
 - EverFlow rubber spray nozzles
 - Total spray for complete coverage
 - Solid brass ball joint
 - Contemporary/Modern style

MODEL	FINISH	PRICE
<i>2.0 gpm (7.6 L/min) standard</i>		
482SHSQ	Chrome	98.35
482SHSQSTN	Satin Nickel	127.45
482SHSQMB	Matte Black	138.30
482SHSQBBZ	Brushed Bronze	138.30
<i>1.5 gpm (5.7 L/min) WaterSense®, CALGreen</i>		
482SHSQ15	Chrome	98.35
482SHSQSTN15	Satin Nickel	127.45
482SHSQMB15	Matte Black	138.30
482SHSQBBZ15	Brushed Bronze	138.30



- DESCRIPTION**
- Single-Function Showerhead
 - 8" square
 - HydroMersion technology for increased force
 - EverFlow rubber spray nozzles
 - Total spray for complete coverage
 - Solid brass ball joint
 - Contemporary/Modern style

MODEL	FINISH	PRICE
<i>2.0 gpm (7.6 L/min) standard</i>		
682SHSQ	Chrome	209.25
682SHSQSTN	Satin Nickel	272.00
682SHSQMB	Matte Black	292.95
682SHSQBBZ	Brushed Bronze	292.95
<i>1.5 gpm (5.7 L/min) WaterSense®, CALGreen</i>		
682SHSQ15	Chrome	209.25
682SHSQSTN15	Satin Nickel	272.00
682SHSQMB15	Matte Black	292.95
682SHSQBBZ15	Brushed Bronze	292.95



- DESCRIPTION**
- Single-Function Showerhead
 - Standard on the Verity collection
 - 7" square
 - HydroMersion technology for increased force
 - EverFlow rubber spray nozzles
 - Total spray for complete coverage
 - Solid brass ball joint
 - Contemporary/Modern style

MODEL	FINISH	PRICE
<i>2.0 gpm (7.6 L/min) standard</i>		
491SH	Chrome	74.05
491SHSTN	Satin Nickel	96.30
491SHMB	Matte Black	103.60
<i>1.5 gpm (5.7 L/min) WaterSense®, CALGreen</i>		
491SH15	Chrome	74.05
491SHSTN15	Satin Nickel	96.30
491SHMB15	Matte Black	103.60



- DESCRIPTION**
- Single-Function Showerhead
 - 4" diameter
 - HydroMersion technology for increased force
 - Total spray for complete coverage
 - EverFlow rubber spray nozzles
 - Solid brass ball joint
 - Traditional style

MODEL	FINISH	PRICE
<i>2.0 gpm (7.6 L/min) standard</i>		
582SH	Chrome	74.05
582SHSTN	Satin Nickel	96.30
582SHMB	Matte Black	103.60
582SHBBZ	Brushed Bronze	103.60
<i>1.5 gpm (5.7 L/min) WaterSense®, CALGreen</i>		
582SH15	Chrome	74.05
582SHSTN15	Satin Nickel	96.30
582SHMB15	Matte Black	103.60
582SHBBZ15	Brushed Bronze	103.60



Showerheads (Ball Joint Type)



DESCRIPTION	MODEL	FINISH	PRICE
<ul style="list-style-type: none"> • Multifunction Showerhead • Standard on the Braston collection • 4" diameter • 7 modes • HydroMersion technology for increased force • EverFlow rubber spray nozzles • Easy-shift thumb lever • Solid brass ball joint • Traditional style 	<i>2.0 gpm (7.6 L/min) standard</i>		
	582SH7	Chrome	109.05
	582SH7STN	Satin Nickel	141.75
	582SH7MB	Matte Black	153.70
	582SH7BBZ	Brushed Bronze	153.70
	<i>1.5 gpm (5.7 L/min) WaterSense®, CALGreen</i>		
	582SH715	Chrome	109.05
	582SH7STN15	Satin Nickel	141.75
	582SH7MB15	Matte Black	153.70
	582SH7BBZ15	Brushed Bronze	153.70

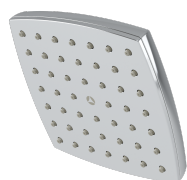

<ul style="list-style-type: none"> • Single-Function Showerhead • Standard on the Oak collection • 5" square • HydroMersion technology for increased force • EverFlow rubber spray nozzles • Total spray for complete coverage • Solid brass ball joint • Transitional style 	<i>2.0 gpm (7.6 L/min) standard</i>		
	562SH	Chrome	109.05
	562SHSTN	Satin Nickel	141.75
	562SHMB	Matte Black	152.65
	562SHBBZ	Brushed Bronze	152.65
	<i>1.5 gpm (5.7 L/min) WaterSense®, CALGreen</i>		
	562SH15	Chrome	109.05
	562SHSTN15	Satin Nickel	141.75
	562SHMB15	Matte Black	152.65
	562SHBBZ15	Brushed Bronze	152.65









<ul style="list-style-type: none"> • Single-Function Showerhead • Standard on the Birch collection • 4" diameter • HydroMersion technology for increased force • Total spray for complete coverage • EverFlow rubber spray nozzles • Solid brass ball joint • Transitional style 	<i>2.0 gpm (7.6 L/min) standard</i>		
	592SH	Chrome	74.05
	592SHSTN	Satin Nickel	96.30
	<i>1.5 gpm (5.7 L/min) WaterSense®, CALGreen</i>		
	592SH15	Chrome	74.05
	592SHSTN15	Satin Nickel	96.30





<ul style="list-style-type: none"> • Multifunction Showerhead • Standard on the Elm collection • 4" diameter • 7 modes • HydroMersion technology for increased force • EverFlow rubber spray nozzles • Easy-shift thumb lever • Solid brass ball joint • Transitional style 	<i>2.0 gpm (7.6 L/min) standard</i>		
	592SH7	Chrome	109.05
	592SH7STN	Satin Nickel	141.80
	592SH7MB	Matte Black	153.70
	592SH7BBZ	Brushed Bronze	153.70
	<i>1.5 gpm (5.7 L/min) WaterSense®, CALGreen</i>		
	592SH715	Chrome	109.05
	592SH7STN15	Satin Nickel	141.80
	592SH7MB15	Matte Black	153.70
	592SH7BBZ15	Brushed Bronze	153.70



Showerheads (Ball Joint Type)











	DESCRIPTION	MODEL	FINISH	PRICE
 <ul style="list-style-type: none"> • Single-Function Showerhead • 5-3/4" diameter • Easy to clean rubber nozzles 	<p>WS P</p>	<i>2.0 gpm (7.6 L/min) standard</i>		
		532SH	Chrome	224.60
		532SH-STN	Satin Nickel	314.25
		532SHMB	Matte Black	314.25
		<i>1.5 gpm (5.7 L/min) WaterSense®, CALGreen</i>		
		532SH-1.5	Chrome	224.60
		532SH-STN-1.5	Satin Nickel	314.25
532SHMB15	Matte Black	314.25		
 <ul style="list-style-type: none"> • Single-Function Showerhead • 7-1/2" diameter • Easy to clean rubber nozzles • Recommend A18 shower arm for 1.5 gpm 	<p>WS P</p>	<i>2.0 gpm (7.6 L/min) standard</i>		
		432SH	Chrome	297.20
		432SH-STN	Satin Nickel	415.90
		432SHMB	Matte Black	416.10
		<i>1.5 gpm (5.7 L/min) CALGreen</i>		
		432SH-1.5	Chrome	297.20
		432SH-STN-1.5	Satin Nickel	415.90
432SH-MB-1.5	Matte Black	416.10		
 <ul style="list-style-type: none"> • Multifunction Showerhead • 4-3/4" diameter • 5 modes • Easy to clean rubber spray nozzles • 2.0 gpm (7.6 L/min) flow rate 	<p>WS P</p>	10262SH520	Chrome	67.55
		10262SH5STN20	Satin Nickel	87.80
		10262SH5MB20	Matte Black	94.55
 <ul style="list-style-type: none"> • Single-Function Rain Showerhead • 12" diameter • 2.0 gpm (7.6 L/min) flow rate 	<p>P</p>	402SH1	Chrome	588.70
		402SH1-STN	Satin Nickel	824.05
 <ul style="list-style-type: none"> • Single-Function Showerhead • Female ball joint connection • 2-3/4" diameter • Easy to clean rubber nozzles • 2.0 gpm (7.6 L/min) flow rate 	<p>CG WS</p>	<i>2.0 gpm (7.6 L/min) standard</i>		
		4-141	Chrome	63.25
		4-141-STN	Satin Nickel	106.50
		<i>1.5 gpm (5.7 L/min) WaterSense®, CALGreen</i>		
		4-141-1.5	Chrome	63.25
		4-141-STN-1.5	Satin Nickel	101.20
 <ul style="list-style-type: none"> • Multifunction Showerhead • Standard on the Allura collection • 3-3/4" diameter • 3 modes • Easy to clean rubber nozzles 	<p>CG WS</p>	4-143	Chrome	147.50
		4-143-STN	Satin Nickel	226.25

Showerheads (Ball Joint Type)

	DESCRIPTION	MODEL	FINISH	PRICE
	• Single-Function Showerhead	4-241	Chrome	198.65
	• 3-1/2" diameter	4-241-STN	Satin Nickel	278.15
	• Easy to clean rubber nozzles			
	• 2.0 gpm (7.6 L/min) flow rate			
	• Single-Function Showerhead	4-137	Chrome	113.00
	• 2-1/4" diameter			
	• 2.0 gpm (7.6 L/min) flow rate			
	• 2-Function Showerhead	4-221	Chrome	250.10
	• External volume control	4-221-STN	Satin Nickel	350.30
	• 3-1/4" diameter			
	• 2.0 gpm (7.6 L/min) flow rate			
	• 2-Function Showerhead	4-231	Chrome	162.15
	• 3-1/4" diameter	4-231-STN	Satin Nickel	243.15
	• 2.0 gpm (7.6 L/min) flow rate			
	P			

Modifications for Showerheads (Ball Joint Type)					
SUFFIX	DESCRIPTION	CHROME	STN	BBZ	MB
15	CG 1.5 gpm (5.7 L/min) flow restrictor	N/A	N/A	N/A	N/A

Showerheads (Institutional Type)

	DESCRIPTION	MODEL	FINISH	PRICE
	<ul style="list-style-type: none"> • Single-Function Showerhead • 1/2" sweat connection • 2.0 gpm (7.6 L/min) flow rate 	<i>2.0 gpm (7.6 L/min) standard</i>		
		4-150	Chrome	300.75
		<i>1.5 gpm (5.7 L/min) CALGreen</i>		
		4-150-1.5	Chrome	300.75
	CG WS 			
	<ul style="list-style-type: none"> • Single-Function Showerhead • 15-degree spray angle • 1/2" sweat connection • 2.0 gpm (7.6 L/min) flow rate 	<i>2.0 gpm (7.6 L/min) standard</i>		
		4-150-15	Chrome	300.75
		<i>1.5 gpm (5.7 L/min) CALGreen</i>		
		4-150-15-1.5	Chrome	300.75
	CG WS 			
	<ul style="list-style-type: none"> • Single-Function Showerhead • 1/2" sweat connection • 2.0 gpm (7.6 L/min) flow rate 	<i>2.0 gpm (7.6 L/min) standard</i>		
		4-151	Chrome	589.15
	WS 			
	<ul style="list-style-type: none"> • Single-Function Showerhead • Vandal resistant • 2.0 gpm (7.6 L/min) flow rate 	<i>2.0 gpm (7.6 L/min) standard</i>		
		4-282F	Chrome	160.65
		<i>1.5 gpm (5.7 L/min) CALGreen</i>		
		4-282F-1.5	Chrome	160.65
	CG			
	<ul style="list-style-type: none"> • Single-Function Showerhead • Vandal resistant • 2.0 gpm (7.6 L/min) flow rate 	<i>2.0 gpm (7.6 L/min) standard</i>		
		4-285F	Chrome	128.85
		<i>1.5 gpm (5.7 L/min) CALGreen</i>		
		4-285F-1.5	Chrome	128.85
	CG			
	<ul style="list-style-type: none"> • Single-Function Showerhead • 1/2" sweat connection • 2.0 gpm (7.6 L/min) flow rate 	<i>2.0 gpm (7.6 L/min) standard</i>		
		4-295	Chrome	376.60
		<i>1.5 gpm (5.7 L/min) WaterSense®, CALGreen</i>		
		4-295-1.5	Chrome	376.60
	CG 			

Showerheads (Institutional Type)



DESCRIPTION	MODEL	FINISH	PRICE
<ul style="list-style-type: none"> • Single-Function Showerhead • 15-degree spray angle • 1/2" sweat connection • 2.0 gpm (7.6 L/min) flow rate 	<i>2.0 gpm (7.6 L/min) standard</i>		
	4-295-15	Chrome	376.60
	<i>1.5 gpm (5.7 L/min) WaterSense®, CALGreen</i>		
	4-295-15-1.5	Chrome	376.60









<ul style="list-style-type: none"> • Single-Function Showerhead with Short Head Bracket • 1/2" female thread connection • 2.0 gpm (7.6 L/min) flow rate 	<i>2.0 gpm (7.6 L/min) standard</i>		
	4-385	Chrome	251.65
	<i>1.5 gpm (5.7 L/min) CALGreen</i>		
	4-385-1.5	Chrome	251.65









Modifications for Showerheads (Institutional Type)

SUFFIX	DESCRIPTION	PRICE
1.5	1.5 gpm (5.7 L/min) flow restrictor (not available for 4-385, 4-282, 4-270, 4-285, 4-151)	N/C
A	Anchor plate for use with ceramic tile	29.55
B	Back plate and bolts for extra thick wall	53.55

Shower Arms and Head Brackets

	DESCRIPTION	MODEL	FINISH	PRICE
	• Shower arm and flange	562SA	Chrome	101.55
	• Standard on the Oak collection	562SASTN	Satin Nickel	132.05
	• 8" length	562SAMB	Matte Black	142.25
		562SABBZ	Brushed Bronze	142.25
P				
	• Shower Arm and Flange	582SA	Chrome	101.55
	• Standard on the Braston collection	582SASTN	Satin Nickel	132.05
	• 8-1/4" length	582SAMB	Matte Black	142.25
	• Matte Black finish is Special Order	582SABBZ	Brushed Bronze	142.25
P				
	• Shower arm with heavy flange	300	Chrome	83.00
	• 8" length	300-STN	Satin Nickel	107.50
		300-MB	Matte Black	104.45
		300-BBZ	Brushed Bronze	104.45
P				
	• Long shower arm and flange	300M	Chrome	53.95
	• Stamped flange	300M-STN	Satin Nickel	63.20
	• 8" length			
P				
	• Short shower arm and flange	300S	Chrome	26.85
	• Stamped flange	300S-STN	Satin Nickel	40.30
	• 6" length	300S-MB	Matte Black	41.25
		300S-BBZ	Brushed Bronze	41.25
P				
	• Shower Arm and Flange	300SQ	Chrome	92.35
	• Standard on Duro and Verity collections	300SQ-STN	Satin Nickel	120.05
	• Metal square flange	300SQ-MB	Matte Black	129.85
	• 8" length	300SQ-BBZ	Brushed Bronze	129.85
P				

Shower Arms and Head Brackets

	DESCRIPTION	MODEL	FINISH	PRICE
	<ul style="list-style-type: none"> • Head bracket • 4 1/4" length 	301	Chrome	105.05
	<ul style="list-style-type: none"> • Shower arm • 6" length 	304 304-STN	Chrome Satin Nickel	95.40 131.90
	<ul style="list-style-type: none"> • Extended head bracket • Concealed back inlet • 5" length 	4-440	Chrome	425.00
	<ul style="list-style-type: none"> • Extended head bracket • Exposed bottom inlet • 5" length 	4-445	Chrome	425.00
	<ul style="list-style-type: none"> • Shower arm • 7 3/8" length 	522SA 522SA-STN	Chrome Satin Nickel	85.60 123.40
	<ul style="list-style-type: none"> • Wall mounted shower arm and flange • 18" length 	A18 A18-STN A18MB	Chrome Satin Nickel Matte Black	136.90 178.10 197.15

P

P

P

Shower Arms and Head Brackets

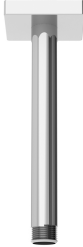
	DESCRIPTION	MODEL	FINISH	PRICE
	<ul style="list-style-type: none"> • Overhead shower arm and flange • 8" length 	CA-8	Chrome	95.80
		CA-8-STN	Satin Nickel	134.00
		CA-8-BBZ	Brushed Bronze	134.15
	P			
	<ul style="list-style-type: none"> • Overhead shower arm and flange • Square escutcheon • 8" length 	CA-8-SQ	Chrome	110.05
		CA-8-SQ-STN	Satin Nickel	154.20
	P			

Hand Showers



DESCRIPTION	MODEL	FINISH	PRICE
	<i>2.0 gpm (7.6 L/Min) standard</i>		
• Single-Function Hand Shower Wand	482W	Chrome	85.75
• Standard on the Identity collection	482WSTN	Satin Nickel	111.45
• 4" diameter	482WMB	Matte Black	120.05
• HydroMersion technology for increased force	482WBBZ	Brushed Bronze	120.05
	<i>1.5 gpm (5.7 L/min) WaterSense®, CALGreen</i>		
• Total spray for complete coverage	482W	Chrome	85.75
• Pause mode for non-positive shutoff	482WSTN15	Satin Nickel	111.45
• EverFlow rubber spray nozzles	482WMB15	Matte Black	120.05
• Easy-shift thumb lever	482WBBZ15	Brushed Bronze	120.05
• Contemporary/Modern style			



• Single-Function Hand Shower System	HR501	Chrome	440.10
• Standard on the Identity collection	HR501STN	Satin Nickel	572.15
• 4" HydroMersion hand shower wand with Total spray Pause mode	HR501MB	Matte Black	616.15
	HR501BBZ	Brushed Bronze	616.15
• EverFlow rubber spray nozzles			
• Wall cradle and elbow			
• 60" flexible metal hose			
• Contemporary/Modern style			
• 2.0 gpm (7.6 L/min) flow rate			



• Single-Function Hand Shower Slide Bar System	HR521	Chrome	530.05
	HR521STN	Satin Nickel	689.10
• Coordinates with the Identity collection	HR521MB	Matte Black	742.05
• 4" HydroMersion hand shower wand with Total spray and Pause mode	HR521BBZ	Brushed Bronze	742.05
• EverFlow rubber spray nozzles			
• 30" hand shower slide bar			
• 60" flexible metal hose			
• Contemporary/Modern style			
• 2.0 gpm (7.6 L/min) flow rate			



	<i>2.0 gpm (7.6 L/Min) standard</i>		
• Multifunction Hand Shower Wand	482W7	Chrome	112.90
• Standard on the Dia collection	482W7STN	Satin Nickel	146.80
• 4" diameter	482W7MB	Matte Black	158.05
• 7 modes	482W7BBZ	Brushed Bronze	158.05
• HydroMersion technology for increased force			
	<i>1.5 gpm (5.7 L/min) WaterSense®, CALGreen</i>		
• EverFlow rubber spray nozzles	482W715	Chrome	112.90
• Easy-shift thumb lever	482W7STN15	Satin Nickel	146.80
• Pause mode for non-positive shutoff	482W7MB15	Matte Black	158.05
• Contemporary/Modern style	482W7BBZ15	Brushed Bronze	158.05



Hand Showers



DESCRIPTION	MODEL	FINISH	PRICE
• Multifunction Hand Shower System	HR507	Chrome	467.25
• Coordinates with the Dia collection	HR507STN	Satin Nickel	607.45
• 4" HydroMersion hand shower wand with 7 modes	HR507MB HR507BBZ	Matte Black Brushed Bronze	654.20 654.20
• EverFlow rubber spray nozzles			
• Wall cradle and elbow			
• 60" flexible metal hose			
• Contemporary/Modern style			
• 2.0 gpm (7.6 L/min) flow rate			

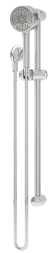

• Multifunction Hand Shower Slide Bar System	HR527 HR527STN	Chrome Satin Nickel	557.20 724.35
• Coordinates with the Dia collection	HR527MB	Matte Black	780.05
• 4" HydroMersion hand shower wand with 7 modes	HR527BBZ	Brushed Bronze	780.05
• EverFlow rubber spray nozzles			
• 30" hand shower slide bar			
• 60" flexible metal hose			
• Contemporary/Modern style			
• 2.0 gpm (7.6 L/min) flow rate			



DESCRIPTION	MODEL	FINISH	PRICE
• Single-Function Hand Shower Wand	<i>2.0 gpm (7.6 L/Min) standard</i>		
• Standard on the Duro and Verity collections	482WSQ	Chrome	145.50
	482WSQSTN	Satin Nickel	189.20
• 2-1/2" x 4-1/2" spray head	482WSQMB	Matte Black	203.80
• HydroMersion technology for increased force	482WSQBBZ	Brushed Bronze	203.80
	<i>1.5 gpm (5.7 L/min) WaterSense®, CALGreen</i>		
• EverFlow rubber spray nozzles	482WSQ15	Chrome	145.50
• Total spray for complete coverage	482WSQSTN15	Satin Nickel	189.20
• Push-button Pause mode for non-positive shutoff	482WSQMB15 482WSQBBZ15	Matte Black Brushed Bronze	203.80 203.80
• Contemporary/Modern style			



Hand Showers



DESCRIPTION	MODEL	FINISH	PRICE
• Single-Function Hand Shower System	HS501	Chrome	499.90
• Coordinates with Duro and Verity collections	HS501STN HS501MB	Satin Nickel Matte Black	649.90 699.90
• 2 1/2" x 4" HydroMersion hand shower wand with Total spray and push-button Pause mode	HS501BBZ	Brushed Bronze	699.90



• Single-Function Hand Shower Slide Bar System	HS521 HS521STN	Chrome Satin Nickel	502.85 653.70
• Coordinates with Duro and Verity collections	HS521MB HS521BBZ	Matte Black Brushed Bronze	703.95 703.95
• 2-1/2" x 4-1/2" HydroMersion hand shower wand with Total spray and push-button Pause mode			
• EverFlow rubber spray nozzles			
• 30" hand shower slide bar			
• 60" flexible metal hose			
• Contemporary/Modern style			
• 2.0 gpm (7.6 L/min) flow rate			



DESCRIPTION	MODEL	FINISH	PRICE
• Multifunction Hand Shower Wand	<i>2.0 gpm (7.6 L/Min) standard</i>		
• Standard on the Braston collection	582W7	Chrome	112.90
• 4" diameter	582W7STN	Satin Nickel	146.80
• 7 modes	582W7MB	Matte Black	158.05
• HydroMersion technology for increased force	582W7BBZ	Brushed Bronze	158.05
	<i>1.5 gpm (5.7 L/min) WaterSense®, CALGreen</i>		
• EverFlow rubber spray nozzles	582W715	Chrome	112.90
• Easy-shift thumb lever	582W7STN15	Satin Nickel	146.80
• Pause mode for non-positive shutoff	582W7MB15	Matte Black	158.05
• Traditional style	582W7BBZ15	Brushed Bronze	158.05



Hand Showers



DESCRIPTION	MODEL	FINISH	PRICE
• Multifunction Hand Shower System	HR707	Chrome	440.10
• Coordinates with Allura and Braston collections	HR707STN	Satin Nickel	572.15
	HR707MB	Matte Black	616.15
• 4" HydroMersion hand shower wand with 7 modes	HR707BBZ	Brushed Bronze	616.15
• EverFlow rubber spray nozzles			
• Integrated wall cradle and elbow			
• 60" flexible metal hose			
• Traditional style			
• 2.0 gpm (7.6 L/min) flow rate			



• Multifunction Hand Shower Slide Bar System	HR727	Chrome	530.10
	HR727STN	Satin Nickel	689.10
• Coordinates with Allura and Braston collections	HR727MB	Matte Black	742.05
	HR727BBZ	Brushed Bronze	742.05
• 4" HydroMersion hand shower wand with 7 modes			
• EverFlow rubber spray nozzles			
• 30" hand shower slide bar			
• 60" flexible metal hose			
• Traditional style			
• 2.0 gpm (7.6 L/min) flow rate			



• Single-Function Hand Shower Wand	<i>2.0 gpm (7.6 L/Min) standard</i>		
• Standard on the Oak collection	562W	Chrome	145.50
• 4" square	562WSTN	Satin Nickel	189.20
• HydroMersion technology for increased force	562WMB	Matte Black	203.80
	562WBBZ	Brushed Bronze	203.80
• EverFlow rubber spray nozzles	<i>1.5 gpm (5.7 L/min) WaterSense®, CALGreen</i>		
• Total spray for complete coverage	562W15	Chrome	145.50
• Push-button Pause mode for non-positive shutoff	562WSTN15	Satin Nickel	189.20
	562WMB15	Matte Black	203.80
• Transitional style	562WBBZ15	Brushed Bronze	203.80



Hand Showers



DESCRIPTION	MODEL	FINISH	PRICE
• Single-Function Hand Shower System	HS601	Chrome	499.90
• Coordinates with the Oak collection	HS601STN	Satin Nickel	649.90
• 4" HydroMersion hand shower wand with Total spray and push-button Pause mode	HS601MB	Matte Black	699.90
	HS601BBZ	Brushed Bronze	699.90
• EverFlow rubber spray nozzles			
• Integrated wall cradle and elbow			
• 60" flexible metal hose			
• Transitional style			
• 2.0 gpm (7.6 L/min) flow rate			



• Single-Function Hand Shower Slide Bar System	HS621	Chrome	589.90
	HS621STN	Satin Nickel	766.80
• Standard on the Oak collection	HS621MB	Matte Black	825.80
• 4" HydroMersion hand shower wand with Total spray and push-button Pause mode	HS621BBZ	Brushed Bronze	825.80
• EverFlow rubber spray nozzles			
• 30" hand shower slide bar			
• 60" flexible metal hose			
• Transitional style			
• 2.0 gpm (7.6 L/min) flow rate			



• Single-Function Hand Shower Wand	<i>2.0 gpm (7.6 L/Min) standard</i>		
• Standard on the Birch collection	592W	Chrome	85.75
• 4" diameter	592WSTN	Satin Nickel	111.45
• HydroMersion technology for increased force	<i>1.5 gpm (5.7 L/min) WaterSense®, CALGreen</i>		
• Total spray for complete coverage	592W15	Chrome	85.75
• Pause mode for non-positive shutoff	592WSTN15	Satin Nickel	111.45
• Easy-shift thumb lever			
• EverFlow rubber spray nozzles			
• Transitional style			



• Single-Function Hand Shower System	HR601	Chrome	440.10
• Coordinates with the Birch collection	HR601STN	Satin Nickel	572.15
• 4" HydroMersion hand shower wand with Total spray and Pause mode			
• EverFlow rubber spray nozzles			
• Wall cradle and elbow			
• 60" flexible metal hose			
• Transitional style			
• 2.0 gpm (7.6 L/min) flow rate			



Hand Showers

DESCRIPTION	MODEL	FINISH	PRICE
<ul style="list-style-type: none"> • Single-Function Hand Shower Slide Bar System 	HR621	Chrome	530.10
	HR621STN	Satin Nickel	689.10
<ul style="list-style-type: none"> • Coordinates with the Birch collection • 4" HydroMersion hand shower wand with Total spray and Pause mode • EverFlow rubber spray nozzles • 30" hand shower slide bar • 60" flexible metal hose • Transitional style • 2.0 gpm (7.6 L/min) flow rate 			



DESCRIPTION	MODEL	FINISH	PRICE
<ul style="list-style-type: none"> • Multifunction Hand Shower Wand 	<i>2.0 gpm (7.6 L/Min) standard</i>		
	592W7	Chrome	112.90
<ul style="list-style-type: none"> • Standard on the Elm collection 	592W7STN	Satin Nickel	146.80
	592W7MB	Matte Black	158.05
<ul style="list-style-type: none"> • 7 modes 	592W7BBZ	Brushed Bronze	158.05
	<i>1.5 gpm (5.7 L/min) WaterSense®, CALGreen</i>		
<ul style="list-style-type: none"> • HydroMersion technology for increased force • EverFlow rubber spray nozzles • Easy-shift thumb lever • Pause mode for non-positive shutoff • Transitional style 	592W715	Chrome	112.90
	592W7STN15	Satin Nickel	146.80
	592W7MB15	Matte Black	158.05
	592W7BBZ15	Brushed Bronze	158.05



<ul style="list-style-type: none"> • Multifunction Hand Shower System • Standard on the Elm collection • 4" HydroMersion hand shower wand with 7 modes • EverFlow rubber spray nozzles • Wall cradle and elbow • 60" flexible metal hose • Transitional style • 2.0 gpm (7.6 L/min) flow rate 	HR607	Chrome	467.25
	HR607STN	Satin Nickel	607.45
	HR607MB	Matte Black	654.20
	HR607BBZ	Brushed Bronze	654.20



<ul style="list-style-type: none"> • Multifunction Hand Shower Slide Bar System • Coordinates with the Elm collection • 4" HydroMersion hand shower wand with 7 modes • EverFlow rubber spray nozzles • 30" hand shower slide bar • 60" flexible metal hose • Transitional style • 2.0 gpm (7.6 L/min) flow rate 	HR627	Chrome	557.20
	HR627STN	Satin Nickel	724.35
	HR627MB	Matte Black	780.05
	HR627BBZ	Brushed Bronze	780.05



Hand Showers

	DESCRIPTION	MODEL	FINISH	PRICE
	• Single-Function Hand Shower Wand	432W	Chrome	193.35
	• 1" diameter	432W-STN	Satin Nickel	270.75
	• 2.0 gpm (7.6 L/min) flow rate	432WMB	Matte Black	270.75
		432WBBZ	Brushed Bronze	270.75
	P			
	• Single-Function Hand Shower System	HR101	Chrome	411.75
	• 1" single-function hand shower wand	HR101STN	Satin Nickel	535.30
	• Integrated wall cradle and elbow	HR101MB	Matte Black	576.50
	• 60" flexible metal hose	HR101BBZ	Brushed Bronze	576.50
	• Contemporary/Modern style			
	• 2.0 gpm (7.6 L/min) flow rate			
	P			
	• Multifunction Handheld Showerhead	HSA507	Chrome	346.90
	• 4" HydroMersion hand shower wand with 7 modes	HSA507STN	Satin Nickel	450.95
	• EverFlow rubber spray nozzles	HSA507MB	Matte Black	485.65
		HSA507BBZ	Brushed Bronze	485.65
	• Shower arm, flange and wand cradle adaptor included			
	• 60" flexible metal hose			
	• Contemporary/Modern style			
	• 2.0 gpm (7.6 L/min) flow rate			
	• Multifunction Hand Shower Wand	10262W5	Chrome	81.25
	• 4-3/4" diameter	10262W5STN	Satin Nickel	120.05
	• 5 modes	10262W5MB	Matte Black	129.30
	• 2.0 gpm (7.6 L/min) flow rate			
	• ADA Hand Shower Wand	ADACHS	Chrome	108.60
	• 3-3/8" diameter	ADACHS-STN	Satin Nickel	152.05
	• Non-positive shutoff button	ADACHS-MB	Matte Black	157.60
	• 2.0 gpm (7.6 L/min) flow rate	ADACHS-BBZ	Brushed Bronze	157.60
		ADACHS-WHT	White	79.00
				

Hand Showers

	DESCRIPTION	MODEL	FINISH	PRICE
	<ul style="list-style-type: none"> • Single-Function Hand Shower Wand • 2-3/4" diameter • 2.0 gpm (7.6 L/min) flow rate 	EF-100	Chrome	119.60
		EF-100-STN	Satin Nickel	237.60
		EF-100-MB	Matte Black	237.60
		EF-100-BBZ	Brushed Bronze	237.60
	WS P			
	<ul style="list-style-type: none"> • Single-Function Hand Shower Wand • 3-3/4" diameter • 2.0 gpm (7.6 L/min) flow rate 	EF-118	Chrome	211.05
		EF-118-STN	Satin Nickel	257.10
	WS P			
	<ul style="list-style-type: none"> • Single-Function Hand Shower System • 3" white hand shower wand • Wall cradle and elbow • 60" flexible metal hose • 2.0 gpm (7.6 L/min) flow rate 	FS	Chrome	382.85
	<ul style="list-style-type: none"> • Single-Function Hand Shower Slide Bar System • 3" white hand shower wand • 30" slide bar with cradle for hand shower mounting • 60" flexible metal hose • 2.0 gpm (7.6 L/min) flow rate 	FSB	Chrome	545.00
		FSB-STN	Satin Nickel	967.70
	<ul style="list-style-type: none"> • Single-Function Hand Shower Slide Bar System • 3" white hand shower wand • Easy to clean rubber nozzles • Wall connection and flange • 30" slide bar with cradle for hand shower mounting • 60" flexible metal hose • 2.0 gpm (7.6 L/min) flow rate 	T-300B-30-V	Chrome	527.20
		T-300B-30-V-STN	Satin Nickel	808.15

Hand Showers



DESCRIPTION	MODEL	FINISH	PRICE
<ul style="list-style-type: none"> • 1-1/2" Diameter Grab Bar/Slide Bar • ADA slide mechanism • 60" flexible metal hose • ADA Chrome or Satin Nickel hand shower wand with non-positive shutoff • Supply elbow included • Wall connection and flange • 2.0 gpm (7.6 L/min) flow rate 	<i>24" Length</i>		
	T724	Chrome	518.15
	T724-STN	Satin Nickel	637.65
	<i>36" Length</i>		
	T736	Chrome	549.05
	T736-STN	Satin Nickel	674.80
<i>48" Length</i>			
	T748	Chrome	606.10
	T748-STN	Satin Nickel	737.20



<ul style="list-style-type: none"> • 1-1/2" Diameter Grab Bar/Slide Bar • ADA slide mechanism • 60" flexible metal hose • ADA white hand shower wand with non-positive shutoff • Supply elbow included • Wall connection and flange • 2.0 gpm (7.6 L/min) flow rate 	T24-WT	24" White	491.90
	T36-WT	36" White	522.85
	T48-WT	48" White	574.90

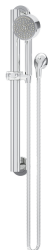







<ul style="list-style-type: none"> • 24" or 36" Slide/Grab Bar • Contemporary/Modern style • 4" HydroMersion hand shower wand with 7 modes • EverFlow rubber spray nozzles • 60" flexible metal hose • 1-1/2" diameter slide bar • Pause mode for non-positive shutoff • ADA slide mechanism • Wall elbow included • 2.0 gpm (7.6 L/min) flow rate 	<i>24" Length</i>		
	H35924	Chrome	586.05
	H35924STN	Satin Nickel	770.25
	H35924MB	Matte Black	820.45
	<i>36" Length</i>		
	H35936	Chrome	598.05
	H35936STN	Satin Nickel	787.05
	H35936MB	Matte Black	834.55





<ul style="list-style-type: none"> • 24" or 36" Slide/Grab Bar • 2-1/2" x 4-1/2" HydroMersion hand shower wand with Total spray and push-button Pause mode • EverFlow rubber spray nozzles • 60" flexible metal hose • 1-1/2" diameter slide bar • ADA slide mechanism • Wall elbow included • Contemporary/Modern style • 2.0 gpm (7.6 L/min) flow rate 	<i>24" Length</i>		
	H36924	Chrome	586.05
	H36924STN	Satin Nickel	770.25
	H36924MB	Matte Black	820.55
	<i>36" Length</i>		
	H36936	Chrome	598.05
	H36936STN	Satin Nickel	787.05
	H36936MB	Matte Black	837.20





Hand Showers

	DESCRIPTION	MODEL	FINISH	PRICE
	<ul style="list-style-type: none"> • Multifunction Hand Shower Wand • Standard on the Allura collection • 3-3/4" diameter • 3 modes • 2.0 gpm (7.6 L/min) flow rate 	EF-101 EF-101-STN	Chrome Satin Nickel	104.65 146.75
	WS P			
	<ul style="list-style-type: none"> • Multifunction Hand Shower Wand • 3-3/4" diameter • 3 modes • 2.0 gpm (7.6 L/min) flow rate 	EF-119	Chrome	254.25
	WS P			
	<ul style="list-style-type: none"> • Multifunction Hand Shower System • Standard on the Allura collection • 3-3/4" hand shower wand with 3 modes • Cradle for hand shower wand mounting • 60" flexible metal hose • 2.0 gpm (7.6 L/min) flow rate 	H303-V H303-V-STN	Chrome Satin Nickel	400.80 673.70
	P			
	<ul style="list-style-type: none"> • Multifunction Hand Shower Slide Bar System • Coordinates with the Allura collection • 3-5/8" hand shower wand with 3 modes • 30" slide bar with cradle for hand shower mounting • 60" flexible metal hose • 2.0 gpm (7.6 L/min) flow rate 	H323-V H323-V-STN	Chrome Satin Nickel	470.80 800.40
	P			
	<ul style="list-style-type: none"> • Hand Shower Unit • Hand shower wand not included • Wall elbow • 30" slide bar with cradle for hand shower mounting 	0368-2HSB-LHS	Chrome	262.45
				
	<ul style="list-style-type: none"> • Slide Mechanism for B30 series 30" Adjusting Bar 	FP-SM3	Chrome	75.05

Hand Showers







	DESCRIPTION	MODEL	FINISH	PRICE
	• Exposed Shower Riser	35EX	Chrome	718.55
	• Round flanges	35EX-STN	Satin Nickel	1006.05
	• Metal lever handle	35EX-MB	Matte Black	1006.05
	• Diverter included for toggling between distinct showerhead and hand shower positions			
	• Includes column/slide bar and hand shower bracket			
	• 60" flexible metal hose			
	• Hand shower and showerhead not included			
				

	• Exposed Shower Riser	36EX	Chrome	718.55
	• Square flanges	36EX-STN	Satin Nickel	1006.05
	• Metal lever handle			
	• Diverter included for toggling between distinct showerhead and hand shower positions			
	• Includes column/slide bar and hand shower bracket			
	• 60" flexible metal hose			
	• Hand shower and showerhead not included			
				





Modifications for Hand Showers

SUFFIX	DESCRIPTION	CHROME	STN	BBZ	MB
15	 1.5 gpm (5.7 L/min) flow restrictor	N/A	N/A	N/A	N/A





Tub Spouts with Diverter

	DESCRIPTION	MODEL	FINISH	PRICE
	• Braston Diverter Tub Spout	582DTS	Chrome	73.95
	• 7-1/16" length	582DTSSTN	Satin Nickel	96.00
	• Pull-up diverter	582DTSMB	Matte Black	103.40
	• Metal construction	582DTSBBZ	Brushed Bronze	103.40
	• Slip-on installation			
	• Matte Black finish is Special Order			
P				
	• Duro Diverter Tub Spout	361DTS	Chrome	251.95
	• 6-1/2" length	361DTS-STN	Satin Nickel	327.55
	• Pull-up diverter	361DTS-MB	Matte Black	354.65
	• Metal construction	361DTS-BBZ	Brushed Bronze	354.65
	• Thread-on installation			
P				
	• Duro Diverter Tub Spout	361DTS-SS	Chrome	251.95
	• 6-1/2" length	361DTS-SS-STN	Satin Nickel	327.55
	• Pull-up diverter	361DTS-MB	Matte Black	354.65
	• Metal construction	361DTS-BBZ	Brushed Bronze	354.65
	• Slip-on installation			
P				
	• Elm Diverter Tub Spout	552TSD	Chrome	115.60
	• 5-7/8" length	552TSD-STN	Satin Nickel	155.85
	• Pull-up diverter	552TSDMB	Matte Black	161.85
	• Metal construction	552TSDBBZ	Brushed Bronze	161.85
	• Thread-on installation			
P				
	• Oak Diverter Tub Spout	562DTS	Chrome	73.95
	• 7-11/16" length	562DTSSTN	Satin Nickel	96.00
	• Pull-up diverter	562DTSMB	Matte Black	103.40
	• Metal construction	562DTSBBZ	Brushed Bronze	103.40
	• Slip-on installation			
P				
	• Verity Diverter Tub Spout	493DTS	Chrome	116.65
	• 5-1/2" length	493DTSSTN	Satin Nickel	151.75
	• Pull-up diverter	493DTSMB	Matte Black	163.40
	• Metal construction			
	• Slip-on installation			
P				

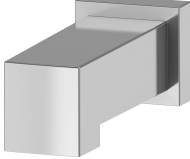
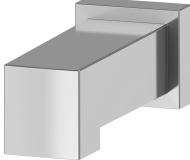

Tub Spouts with Diverter

	DESCRIPTION	MODEL	FINISH	PRICE
	<ul style="list-style-type: none"> • Diverter tub spout • 5-1/2" length • 1/2" inlet • Pull-up diverter • Metal construction • Slip-on installation 	053	Chrome	87.75
		053-STN	Satin Nickel	142.25
	P			
	<ul style="list-style-type: none"> • Diverter tub spout • 5-1/2" length • Pull-up diverter • Metal construction • Thread-on installation 	054	Chrome	73.50
		054-STN	Satin Nickel	106.15
		054MB	Matte Black	114.35
		054BBZ	Brushed Bronze	114.35
	P			
	<ul style="list-style-type: none"> • Diverter tub spout • 7" length • Pull-up diverter • Metal construction • Thread-on installation 	352TS	Chrome	59.25
		352TS-STN	Satin Nickel	79.00
		352TS-MB	Matte Black	83.60
		352TS-BBZ	Brushed Bronze	83.60
	P			
	<ul style="list-style-type: none"> • Diverter tub spout • 7" length • Pull-up diverter • Metal construction • Slip-on installation 	057	Chrome	80.25
		057-STN	Satin Nickel	136.55
		057MB	Matte Black	112.35
		057BBZ	Brushed Bronze	112.35
	P			

Tub Spouts without Diverter

	DESCRIPTION	MODEL	FINISH	PRICE
	• Braston Tub Spout	582TS	Chrome	73.95
	• 7-1/16" length	582TSSTN	Satin Nickel	96.00
	• Metal construction	582TSMB	Matte Black	103.40
	• Slip-on installation	582TSBBZ	Brushed Bronze	103.40
	• Matte Black finish is Special Order			
	P			
	• Duro Non-Diverter Tub Spout	361TS	Chrome	232.40
	• 6" length	361TS-STN	Satin Nickel	302.15
	• Metal construction	361TS-MB	Matte Black	327.25
	• Thread-on installation	361TS-BBZ	Brushed Bronze	327.25
	P			
	• Duro Non-Diverter Tub Spout	361TS-SS	Chrome	232.40
	• 6" length	361TS-SS-STN	Satin Nickel	302.15
	• Metal construction			
	P			
	• Elm Non-Diverter Tub Spout	552TS	Chrome	111.55
	• 5-7/8" length	552TS-STN	Satin Nickel	150.30
	• Metal construction	552TSMB	Matte Black	156.10
	• Thread-on installation	552TSBBZ	Brushed Bronze	156.10
	P			
	• Oak Tub Spout	562TS	Chrome	73.95
	• 7-11/16" length	562TSSTN	Satin Nickel	96.00
	• Metal construction	562TSMB	Matte Black	103.40
	• Slip-on installation	562TSBBZ	Brushed Bronze	103.40
	P			
	• Verity Tub Spout	493TS	Chrome	76.05
	• 5-1/2" length	493TSSTN	Satin Nickel	98.85
	• Metal construction	493TSMB	Matte Black	106.50
	P			

Tub Spouts without Diverter

	DESCRIPTION	MODEL	FINISH	PRICE
	• Non-diverter tub spout	060	Chrome	32.70
	• 5-1/4" length	060-STN	Satin Nickel	49.60
	• Metal construction	060MB	Matte Black	52.55
	• Thread-on installation	060BBZ	Brushed Bronze	52.50
	P			
	• Non-diverter tub spout	061	Chrome	57.40
	• 5-1/4" length	061-STN	Satin Nickel	93.95
	• Metal construction			
	• Slip-on installation			
	P			
	• Non-diverter tub spout	067	Chrome	66.40
	• 7" length	067-STN	Satin Nickel	92.70
	• Metal construction	067-MB	Matte Black	96.20
	• Thread-on installation	067-BBZ	Brushed Bronze	96.20
	P			

Diverter and Volume Control Valves















	DESCRIPTION	MODEL	FINISH	PRICE
	<ul style="list-style-type: none"> Allura Diverter Valve Trim 5" diameter Screwless escutcheon Dual or triple outlet 	<i>Trim Only: Diverter valve body required (see page 158)</i>		
		47-2DIV-TRM	Chrome	299.00
		47-2DIV-STN-TRM	Satin Nickel	410.75
P 				
	<ul style="list-style-type: none"> Birch Diverter Valve Trim 5" diameter Metal handle Screwless escutcheon Dual or triple outlet 	<i>Trim Only: Diverter valve body required (see page 158)</i>		
		59DIVTRM	Chrome	232.15
		59DIVSTNTRM	Satin Nickel	301.80
P 				
	<ul style="list-style-type: none"> Braston Diverter Valve Trim 5" diameter Metal handle Screwless escutcheon Dual or triple outlet Matte Black finish is Special Order 	<i>Trim Only: Diverter valve body required (see page 158)</i>		
		58DIVTRM	Chrome	349.25
		58DIVSTNTRM	Satin Nickel	454.05
		58DIVMBTRM	Matte Black	489.00
		58DIVBBZTRM	Brushed Bronze	489.00
P 				
	<ul style="list-style-type: none"> Dia Diverter Valve Trim 5" diameter Metal lever handle Screwless escutcheon Dual or triple outlet 	<i>Trim Only: Diverter valve body required (see page 158)</i>		
		35-2DIV-CYL-TRM	Chrome	283.90
		35-2DIV-CYL-STN-TRM	Satin Nickel	415.15
		35-2DIV-CYL-MB-TRM	Matte Black	497.35
		35-2DIV-CYL-BBZ-TRM	Brushed Bronze	497.35
P 				
	<ul style="list-style-type: none"> Duro Diverter Valve Trim 5" square Metal handle Screwless escutcheon Dual or triple outlet 	<i>Trim Only: Diverter valve body required (see page 158)</i>		
		36-2DIV-TRM	Chrome	283.90
		36-2DIV-STN-TRM	Satin Nickel	415.15
		36-2DIV-MB-TRM	Matte Black	497.35
		36-2DIV-BBZ-TRM	Brushed Bronze	497.35
P 				
	<ul style="list-style-type: none"> Elm Diverter Valve Trim 5" diameter Screwless escutcheon Dual or triple outlet Matte Black and Brushed Bronze finishes are Special Order 	<i>Trim Only: Diverter valve body required (see page 158)</i>		
		55-2DIV-TRM	Chrome	263.85
		55-2DIV-STN-TRM	Satin Nickel	385.15
		55DIVMBTRM	Matte Black	369.40
		55DIVBBZTRM	Brushed Bronze	369.40
P 				

Diverters and Volume Control Valves

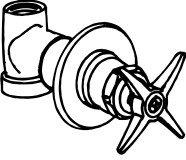
	DESCRIPTION	MODEL	FINISH	PRICE
	• Identity Diverter Valve Trim	<i>Trim Only: Diverter valve body required (see page 158)</i>		
	• 5" diameter	67-DIV-TRM	Chrome	204.30
	• Metal handle	67-DIV-TRM-STN	Satin Nickel	285.45
	• Screwed escutcheon	67DIVTRMMB	Matte Black	286.05
	• Dual or triple outlet	67DIVTRMBBZ	Brushed Bronze	286.05
				
	• Oak Diverter Valve Trim	<i>Trim Only: Diverter valve body required (see page 158)</i>		
	• 5" square	56DIVTRM	Chrome	349.25
	• Metal handle	56DIVSTNTRM	Satin Nickel	454.05
	• Screwless escutcheon	56DIVMBTRM	Matte Black	489.00
	• Dual or triple outlet	56DIVBBZTRM	Brushed Bronze	489.00
• Brushed Bronze finish is Special Order				
				
	• Origins Diverter Trim	<i>Trim Only: Diverter valve body required (see page 158)</i>		
	• 4-1/4" diameter	96-2DIV-PLR	Chrome	366.80
	• Screwed escutcheon	96-2DIV-PLR-STN	Satin Nickel	430.80
	• Dual or triple outlet	<i>Trim Only: Diverter valve body required (see page 158)</i>		
		96-DIV-PLR-TRM	Chrome	162.65
	96-DIV-PLR-TRM-STN	Satin Nickel	227.95	
				
	• Solarity Diverter Valve Trim	<i>Trim Only: Diverter valve body required (see page 158)</i>		
	• 5" diameter	33DIVTRM	Chrome	232.15
	• Metal lever handle	33DIVSTNTRM	Satin Nickel	301.80
	• Dual or triple outlet	33DIVMBTRM	Matte Black	325.05
				
	• Verity Diverter Valve Trim	<i>Trim Only: Diverter valve body required (see page 158)</i>		
	• 5" square	49DIVTRM	Chrome	232.15
	• Metal handle	49DIVSTNTRM	Satin Nickel	301.80
	• Dual or triple outlet	49DIVMBTRM	Matte Black	325.05
				
	• VisuTemp Diverter Valve Trim	<i>Trim Only: Diverter valve body required (see page 158)</i>		
		2DIVVT	Chrome	341.40
		2DIVVT-STN	Satin Nickel	461.10
		<i>Trim Only: Diverter valve body required (see page 158)</i>		
		2DIVVT-TRM	Chrome	136.85
	2DIVVT-STN-TRM	Satin Nickel	258.85	
				

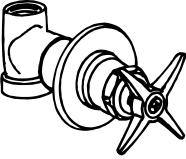

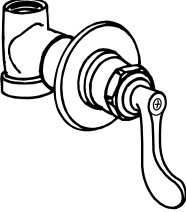



Diverter

 and Volume Control Valves



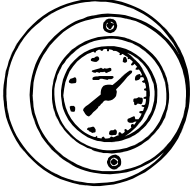

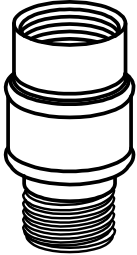



	DESCRIPTION	MODEL	FINISH	PRICE
	<ul style="list-style-type: none"> Dual Outlet Diverter 	<i>Valve & Trim: 2DIV-BODY included (see page 158)</i>		
		2DIV	Chrome	335.40
		<i>Trim Only: 2DIV-BODY required (see page 158)</i>		
		2DIV-TRM	Chrome	57.80
	 			
	<ul style="list-style-type: none"> Triple Outlet Diverter 	<i>Valve & Trim: 3DIV-BODY included (see page 158)</i>		
		3DIV	Chrome	397.70
	 			
	<ul style="list-style-type: none"> Push-Button Dual Outlet Diverter with Volume Control 	4-451	Chrome	283.30
				
	<ul style="list-style-type: none"> Concealed Volume Control Valve 1/2" inlet 	020	Chrome	315.30
				
	<ul style="list-style-type: none"> Concealed Volume Control Valve Positive shutoff 	021	Chrome	315.30
				
	<ul style="list-style-type: none"> Concealed Volume Control Valve Positive shutoff Single blade lever handle 	022	Chrome	420.90
				

Accessories (Miscellaneous)





Accessories

	DESCRIPTION	MODEL	FINISH	PRICE
	• Toe Tester	071	Chrome	194.10
	• 2-1/4" length	071-STN	Satin Nickel	266.65
	• Wall Elbow and Flange	40	Chrome	139.85
		40A-STN	Satin Nickel	138.75
	• Origins Conversion Cover Plate	CC	Chrome	93.00
		CC-STN	Satin Nickel	319.85
 	• Dial Thermometer	G	Chrome	616.95
	• Quick Disconnect Unit	QD	Chrome	160.90
	• For use with hand shower units	QD-STN	Satin Nickel	225.20
 	• Elevated Vacuum Breaker	VB	Chrome	441.80

Grab Bars and Assist Accessories

DESCRIPTION	MODEL	FINISH	PRICE	
 <ul style="list-style-type: none"> • Two-Wall Grab Bar • Metal construction • ADA compliant 	SC-121	Chrome	821.50	
				
  	<i>12" Length</i>			
	<ul style="list-style-type: none"> • ADA grab bar • Metal construction • Horizontal • Grab bar only • Stainless steel finish 	SGB-12	Chrome	95.80
		SGB-12-STN	Satin Nickel	114.85
	<i>18" Length</i>			
		SGB-18	Chrome	103.65
		SGB-18-STN	Satin Nickel	124.55
	<i>24" Length</i>			
		SGB-24	Chrome	151.95
		SGB-24-STN	Satin Nickel	212.90
	<i>36" Length</i>			
		SGB-36	Chrome	183.15
		SGB-36-STN	Satin Nickel	234.95
	<i>42" Length</i>			
		SGB-42	Chrome	199.60
		SGB-42-STN	Satin Nickel	279.55
	<i>48" Length</i>			
		SGB-48	Chrome	234.95
		SGB-48-STN	Satin Nickel	329.00
  	<i>12" Length</i>			
	<ul style="list-style-type: none"> • ADA grab bar • Metal construction • Horizontal • Grab bar only • Textured finish 	SGB-12T	Chrome	105.45
		SGB-12T-STN	Satin Nickel	126.45
	<i>18" Length</i>			
		SGB-18T	Chrome	114.10
		SGB-18T-STN	Satin Nickel	136.80
	<i>24" Length</i>			
		SGB-24T	Chrome	184.40
		SGB-24T-STN	Satin Nickel	212.90
	<i>36" Length</i>			
		SGB-36T	Chrome	222.00
		SGB-36T-STN	Satin Nickel	282.15
	<i>42" Length</i>			
		SGB-42T	Chrome	223.15
		SGB-42T-STN	Satin Nickel	307.60
	<i>48" Length</i>			
		SGB-48T	Chrome	249.85
		SGB-48T-STN	Satin Nickel	361.95
				

Grab Bars and Assist Accessories



	DESCRIPTION	MODEL	FINISH	PRICE
	<ul style="list-style-type: none"> • 24" or 36" Grab Bar • Coordinates with Allura and Braston collections • Metal construction • ADA compliant • Matte Black finish is Special Order 	<i>24" Length</i>		
		583GB24	Chrome	249.15
		583GB24STN	Satin Nickel	323.90
		583GB24MB	Matte Black	348.80
		583GB24BBZ	Brushed Bronze	348.80
		<i>36" Length</i>		
		583GB36	Chrome	261.55
		583GB36STN	Satin Nickel	340.00
		583GB36MB	Matte Black	366.15
		583GB36BBZ	Brushed Bronze	366.15
	<ul style="list-style-type: none"> • 18" or 24" Towel Bar with Assist Bar • Coordinates with Dia and Identity collections • Stainless-steel construction • Durable mounting system • ADA compliant 	<i>18" Length</i>		
		353GBTB-18	Chrome	181.00
		353GBTB-18-STN	Satin Nickel	253.60
		<i>24" Length</i>		
		353GBTB-24	Chrome	201.15
		353GBTB-24-STN	Satin Nickel	281.60
	<ul style="list-style-type: none"> • Toilet Paper Holder with Assist Bar • Coordinates with Dia and Identity collections • Durable mounting system • Stainless-steel construction • ADA compliant 	353GBTP	Chrome	182.90
		353GBTP-STN	Satin Nickel	255.95
				
				

Grab Bars and Assist Accessories

DESCRIPTION	MODEL	FINISH	PRICE
<ul style="list-style-type: none"> • Grab Bar • Coordinates with Dia and Identity collections • Durable mounting system • Stainless-steel construction • Screwless flanges • ADA compliant 	<i>12" Length</i>		
	353GB-12	Chrome	185.50
	353GB-12-STN	Satin Nickel	259.60
	353GB12MB	Matte Black	259.60
	353GB12BBZ	Brushed Bronze	259.60
	<i>18" Length</i>		
	353GB-18	Chrome	199.45
	353GB-18-STN	Satin Nickel	279.25
	353GB18MB	Matte Black	279.25
	353GB18BBZ	Brushed Bronze	265.95
	<i>24" Length</i>		
	353GB-24	Chrome	249.15
	353GB-24-STN	Satin Nickel	335.00
	353GB24MB	Matte Black	335.00
	353GB24BBZ	Brushed Bronze	335.00
	<i>36" Length</i>		
353GB-36	Chrome	261.55	
353GB-36-STN	Satin Nickel	351.70	
353GB36MB	Matte Black	351.70	
353GB36BBZ	Brushed Bronze	351.70	
<i>42" Length</i>			
353GB-42	Chrome	263.65	
353GB-42-STN	Satin Nickel	369.20	
353GB42MB	Matte Black	369.20	
353GB42BBZ	Brushed Bronze	369.20	
<ul style="list-style-type: none"> • 18" or 24" Towel Bar with Assist Bar • Coordinates with the Duro collection • Durable mounting system • Metal construction • Screwless flanges • ADA compliant 	<i>18" Length</i>		
	363GBTB-18	Chrome	181.00
	363GBTB-18-STN	Satin Nickel	253.60
	<i>24" Length</i>		
	363GBTB-24	Chrome	201.15
	363GBTB-24-STN	Satin Nickel	281.60
<ul style="list-style-type: none"> • Toilet Paper Holder with Assist Bar • Coordinates with the Duro collection • Durable mounting system • Metal construction • Screwless flanges • ADA compliant 	363GBTP	Chrome	182.90
	363GBTP-STN	Satin Nickel	255.95
<ul style="list-style-type: none"> • Toilet Paper Holder with Assist Bar • Coordinates with the Duro collection • Durable mounting system • Metal construction • Screwless flanges • ADA compliant 	P 		



Grab Bars and Assist Accessories

DESCRIPTION	MODEL	FINISH	PRICE
 <ul style="list-style-type: none"> • Grab Bar • Coordinates with the Duro collection • Metal construction • Durable mounting system • Screwless flanges • ADA compliant 	<i>12" Length</i>		
	363GB-12	Chrome	193.65
	363GB-12-STN	Satin Nickel	271.20
	<i>18" Length</i>		
	363GB-18	Chrome	215.20
	363GB-18-STN	Satin Nickel	301.25
	<i>24" Length</i>		
	363GB-24	Chrome	239.20
	363GB-24-STN	Satin Nickel	335.00
	<i>36" Length</i>		
	363GB-36	Chrome	251.20
	363GB-36-STN	Satin Nickel	351.70
	<i>42" Length</i>		
	363GB-42	Chrome	263.65
	363GB-42-STN	Satin Nickel	369.20
 <ul style="list-style-type: none"> • 24" or 36" Grab Bar • Coordinates with Oak collection • Metal construction • Screwless flanges • ADA compliant • Brushed Bronze finish is Special Order 	<i>24" Length</i>		
	563GB24	Chrome	249.15
	563GB24STN	Satin Nickel	323.90
	563GB24MB	Matte Black	348.80
	563GB24BBZ	Brushed Bronze	348.80
	<i>36" Length</i>		
	563GB36	Chrome	261.55
	563GB36STN	Satin Nickel	340.00
	563GB36MB	Matte Black	366.15
	563GB36BBZ	Brushed Bronze	366.15



Symmons Genuine Repair Parts should be used to repair or service your Symmons product. Use of replacement parts other than Symmons will void any warranty.

ActivSense Sensor Faucers and Soap Dispensers		
NO.	PART NAME	LIST
SF251	Sensor Kit (Single)	273.45
SF253	Solenoid Valve (Single)	100.65
SF255	Solenoid Housing Kit (Single)	41.75
SF258	Battery Box (batteries not included)	87.45
SF277	3 Meter Output Cable (Male)	25.50
SD010	Soap Dispenser 12V Transformer (power supply)	19.80
SD017	Extension Cable, 4.5 Feet	23.85
SD019	Power Splitter	27.40
SD021	12V Power Supply 2.5 Amp	91.80

ALLURA Pressure Balancing Valve for valve parts see Temptrol		
NO.	PART NAME	LIST
DF-28-LAM	Decorative handle kit (w/chrome insert)	87.80
DF-28-LCF	Decorative handle kit (w/clear faceted insert)	87.80
DF-28-LPO	Decorative handle kit (w/white porcelain insert)	87.80
RTS-026	Shower handle kit	54.15
RTS-032	Allura tub/shower handle kit	37.65
T-19/20	Plastic dome cover and metal lock nut	24.65
T-32	Handle screw and lock washer	3.95
T-33	Plug button	3.95
T-127	Chrome cross handle	87.80
T-130A	S-valve tub/shower dial kit	14.15
T-130B	S-valve shower only dial kit	14.15
T-132	Hot/Cold dial (Model C)	9.95
T-133C	Non-S valve escutcheon kit	52.10
T-139	Diverter/volume control handle	21.20
T3-28	Escutcheon screws (2)	3.95
T3-31S	Solid handle kit	83.55

ALLURA 4" Centerset Lavatory Faucets Prior to April 2012		
NO.	PART NAME	LIST
FLR-110-1.0	1.0 gpm aerator	16.75
FLR-110-1.5	1.5 gpm aerator	16.35
LN-15	2.2 gpm aerator	16.35
LN-02774	Hot cartridge	27.40
LN-02775	Cold cartridge	27.40

ALLURA 4" Centerset Lavatory Faucets May 2012 to Date		
NO.	PART NAME	LIST
FLR-110-1.0	1.0 gpm aerator	16.75
FLR-110-1.5	1.5 gpm aerator	16.35
LN-15	2.2 gpm aerator	16.35
LN-01452	Hot cartridge	27.40
LN-01453	Cold cartridge	27.40
LN-01454	Handle repair kit	58.85
P-100N	Plastic stopper	8.35
RL-072	Repair kit	32.75
RL-118	Lift rod	18.05
RL-120	1.5 gpm aerator	15.10
RL-154LR	Pop up drain, less rod	37.70
RL-235	Lift rod for SLC-4712	18.05

ALLURA Widespread Lavatory Faucets Prior to 2023		
NO.	PART NAME	LIST
FLR-110-1.0	1.0 gpm aerator	16.75
FLR-110-1.5	1.5 gpm aerator	16.35
KN-113	Cold lavatory replacement cartridge	21.75
KN-114	Hot lavatory replacement cartridge	21.75
LN-15	2.2 gpm aerator	16.35
RL-072	Repair kit	32.75
RL-123	Mounting hardware	20.65

BIRCH COLLECTION Lavatory Faucets and Shower Systems		
NO.	PART NAME	LIST
FLR13610	1.0 gpm (3.8 L/min) faucet aerator	13.70
FLR13605	0.5 gpm (1.9 L/min) faucet aerator	13.70
KN-113	Cold lavatory faucet replacement cartridge	16.95
KN-114	Hot lavatory faucet replacement cartridge	16.95
RL-067	Single handle faucet mounting hardware	16.60
RL-081	4" single handle lavatory faucet deck plate	34.20
RL324	Push-pop drain, brass	37.80
RL325	Single handle faucet 25mm cartridge	62.10
RL326	Widespread faucet spout rough	25.50
RL327	Widespread faucet valve flanges	pr. 12.20
RL328	Widespread faucet push-in tee connector	16.00
RL344	Widespread faucet hot valve body	79.50
RL345	Widespread faucet cold valve body	79.50
RL346	Widespread faucet mounting hardware	20.65

RL356	Birch single handle faucet handle kit	46.35
RL360	Birch widespread faucet spout trim kit	55.40
RL361	Birch widespread faucet handle trim kit	pr. 33.95
RTS168	Birch escutcheon kit	110.90
RTS169	Birch VersaFlex escutcheon kit	110.90
RTS170	Birch shower handle	57.95
RTS171	Birch diverter escutcheon kit	110.10
RTS172	Birch diverter lever handle	28.20
RTS173	Birch wall elbow	118.00
T-19/20	Plastic dome cover and metal lock nut	24.65

**BRASTON COLLECTION
Lavatory Faucets and Shower Systems**

NO.	PART NAME	LIST
FLR13605	0.5 gpm (1.9 L/min) faucet aerator	13.70
FLR13610	1.0 gpm (5.7 L/min) faucet aerator	13.70
KN-113	Cold lavatory faucet replacement cartridge	16.95
KN-114	Hot lavatory faucet replacement cartridge	16.95
RL-067	Single handle faucet mounting hardware	16.60
RL-081	4" single handle lavatory faucet deck plate	34.20
RL324	Push-pop drain, brass	37.80
RL325	Single handle faucet 25mm cartridge	62.10
RL326	Widespread faucet spout rough	25.50
RL327	Widespread faucet valve flanges	pr. 11.75
RL328	Widespread faucet push-in tee connector	16.00
RL344	Widespread faucet hot valve body	76.45
RL345	Widespread faucet cold valve body	76.45
RL346	Widespread faucet mounting hardware	20.65
RL357	Braston single handle faucet handle kit	66.40
RL363	Braston widespread faucet spout trim kit	56.20
RL364	Braston widespread faucet handle trim kit	pr. 67.90
RTS161	Braston escutcheon kit	128.15
RTS162	Braston VersaFlex escutcheon kit	128.15
RTS163	Braston shower handle	119.00
RTS164	Braston diverter escutcheon kit	241.55
RTS165	Braston diverter lever	28.20
T-19/20	Plastic dome cover and metal lock nut	24.65

**DIA
Lavatory Faucets and Showers Prior to 2023**

NO.	PART NAME	LIST
FLR-102-0.5	0.5 gpm aerator and key	7.50
P-100N	Plastic stopper	8.35
RL-032	8" deck plate for SPB-3510	111.10
RL-057	Widespread lavatory mounting hardware	20.65
RL-058	Widespread lavatory handle kit	65.75
RL-068	Single post pop up drain assembly	37.70
RL-071	Single post lavatory 0.5 gpm aerator	15.10
RL-154LR	Pop up drain, less rod	37.70
RL-180C	Centerset lavatory cartridge, cold	64.60
RL-180H	Centerset lavatory cartridge, hot	64.60

RL-191	Centerset lift rod	18.05
RL-196	Centerset lavatory 1.0 gpm aerator	15.10
RL-198	Escutcheon kit (2)	32.75
RL-238	Mounting hardware kit for SLS-3510	20.65
RL-250	Cross handle kit	65.75
RL-279	Limit stop cartridge	64.60
RTS-009	Model C brass escutcheon kit (includes mounting hardware and dome cover)	127.85
RTS-010	Model C plastic escutcheon kit (includes mounting hardware and dome cover)	127.85
RTS-011	Model A/B brass escutcheon kit (includes mounting hardware and dome cover)	127.85
RTS-012	Model A/B plastic escutcheon kit (includes mounting hardware and dome cover)	127.85
RTS-013	Brass diverter/volume control handle	25.75
RTS-014	Plastic diverter/volume control handle	6.20
RTS-090	Shower handle, 3520 series	56.85
RTS-091	Shower handle, 3530 series	56.85
T-242A	Tub/shower handle kit	118.90

**DIA COLLECTION
Lavatory Faucets 2023 to Date**

NO.	PART NAME	LIST
FLR13610	1.0 gpm (3.8 L/min) faucet aerator	15.70
FLR13605	0.5 gpm (1.9 L/min) faucet aerator	15.70
KN-113	Cold lavatory replacement cartridge	21.75
KN-114	Hot lavatory replacement cartridge	21.75
RL324	Push-pop drain, brass	39.30
RL326	Widespread faucet spout rough	25.50
RL327	Widespread faucet valve flanges	pr. 12.20
RL328	Widespread faucet push-in tee connector	16.65
RL329	Dia widespread faucet handle trim kit	pr. 52.70
RL330	Dia widespread faucet cross handle trim kit	pr. 52.70
RL335	Dia widespread faucet spout trim kit (SLW3512)	44.95
RL336	Dia widespread faucet spout trim kit (SLW3522)	44.95
RL344	Widespread faucet hot valve body	79.50
RL345	Widespread faucet cold valve body	79.50
RL346	Widespread faucet mounting hardware	20.65

**DIA
Kitchen Faucets Prior to 2023**

NO.	PART NAME	LIST
RK-001	Mounting hardware	20.65
RK-002	Pull-down handle kit	32.75
RK-003	Cartridge	64.60
RK-004	Spray wand	45.80
RK-005	O-ring and dual check	7.85
RK-006	Hose	12.40
RK-007	Installation tool	7.85
RK-013	Handle assembly	32.75
RK-014	Connector repair kit	15.50
RK-015-1.5	Aerator	15.10
RK-022	O-ring repair kit for SPP-3510	9.00

RK-024	Mounting hardware	20.65
RK-030	Spray wand	127.35
RK-032	Hose	46.00
RK-032-GY	Hose	46.00
RO-007	1.5 gpm pull-down aerator	15.10

DIVERTROL DIVERTERS from 1964 to Date

NO.	PART NAME	LIST
DT-2	Bonnet	38.25
DT-3	Spindle assembly	60.40
DT-4	Spacer bushing	11.20
DT-7	Escutcheon bushing	22.40
DT-8	Bonnet o-ring	3.95
DT-9	Bonnet gasket	3.95
DT-10	Packing cup	3.95
DT-11	O-ring washer	3.95
DT-12	Spring	4.50
DT-13	Volume dial & screw	6.00
DT-15	Knob	20.10
DT-20	Replacement unit complete	166.35
LD-15A	Escutcheon with set screw	54.80

DURO Lavatory Faucets and Showers Prior to 2023

NO.	PART NAME	LIST
LN-01416	Single post lavatory handle	67.05
LN-01417	Single post lavatory control cartridge	29.30
P-100N	Plastic stopper	8.35
RL-002	Widespread lavatory handle kit (with screws) (2)	65.75
RL-003	Widespread lavatory hot cartridge	64.60
RL-004	Widespread lavatory cold cartridge	64.60
RL-006	Widespread lavatory lift rod assembly	18.05
RL-011	Mounting kit and hoses	46.00
RL-014	Lift rod, stopper, ball rod	18.05
RL-015	Lift rod	18.05
RL-019	0.5 gpm aerator	15.10
RL-148	Widespread mounting kit	20.65
RL-149	Widespread handle kit	32.75
RL-150	Lift rod	18.05
RL-179	Centerset handle	65.75
RL-180C	Centerset lavatory cartridge, cold	64.60
RL-180H	Centerset lavatory cartridge, hot	64.60
RTS-001	Model C escutcheon kit (includes mounting hardware and dome cover)	127.85
RTS-003	Model A/B escutcheon kit (includes mounting hardware and dome cover)	127.85
RTS-004	Diverter/Volume control handle	29.20
RTS-037	Dome cover repair kit	24.00
RTS-040	Diverter escutcheon kit	127.85
RTS-092	Shower handle, 3620 Series	56.85
RTS-093	Shower handle, 3630 Series	56.85

DURO COLLECTION Lavatory Faucets 2023 to Date

NO.	PART NAME	LIST
FLR13605	0.5 gpm (1.9 L/min) faucet aerator	15.70
FLR13610	1.0 gpm (3.8 L/min) faucet aerator	15.70
KN-113	Cold lavatory faucet replacement cartridge	21.75
KN-114	Hot lavatory faucet replacement cartridge	21.75
RL324	Push-pop drain, brass	39.30
RL326	Widespread faucet spout rough	25.50
RL328	Widespread faucet push-in tee connector	16.65
RL344	Widespread faucet hot valve body	79.50
RL345	Widespread faucet cold valve body	79.50
RL346	Widespread faucet mounting hardware	20.65
RL365	Duro widespread faucet spout trim kit (SLW3612)	44.95
RL366	Duro widespread faucet spout trim kit (SLW3622)	44.95
RL367	Duro widespread faucet handle trim kit	68.55
RL368	Widespread faucet valve flanges	pr. 12.75

ELM Lavatory Faucets Prior to 2023

NO.	PART NAME	LIST
KN-113	Cold lavatory replacement cartridge	21.75
KN-114	Hot lavatory replacement cartridge	21.75
RL-031	Widespread lavatory handle kit	32.75
RL-041	Single post lavatory handle kit	32.75
RL-042	Single post lavatory control cartridge	64.60
RTS-005	Escutcheon repair kit (includes mounting hardware and dome cover)	127.85
RTS-006	Tub/shower handle kit	36.40
RTS-007	Escutcheon repair kit (includes mounting hardware and dome cover)	127.85
RTS-008	Diverter/volume control handle	37.75
RTS-038	Diverter escutcheon kit	127.85

ELM COLLECTION Lavatory Faucets 2023 to Date

NO.	PART NAME	LIST
FLR13605	0.5 gpm (1.9 L/min) faucet aerator	15.70
FLR13610	1.0 gpm (3.8 L/min) faucet aerator	15.70
KN-113	Cold lavatory faucet replacement cartridge	21.75
KN-114	Hot lavatory faucet replacement cartridge	21.75
RL324	Push-pop drain, brass	39.30
RL326	Widespread faucet spout rough	25.50
RL327	Widespread faucet valve flanges	12.20
RL328	Widespread faucet push-in tee connector	16.65
RL332'	Elm widespread faucet handle trim kit	pr. 26.35
RL338	Elm widespread faucet spout trim kit	46.30
RL344	Widespread faucet hot valve body	79.50
RL345	Widespread faucet cold valve body	79.50
RL346	Widespread faucet mounting hardware	20.65

EXPOSED SHOWER RISER

NO.	PART NAME	LIST
RTS-041	Shower riser diverter handle	58.10
RTS-042	Riser diverter cartridge	66.20
RTS-043	Shower riser slide assembly	174.15

FS and FSB Hand Spray Units

NO.	PART NAME	LIST
430SS	Flange only	8.90
FP-1	Open flow hand spray	163.70
FP-1E	Swivel	19.20
FP-1-TEMPROL	Temptrol open flow hand spray	54.35
FP-2	Wall bracket with screws	27.15
FP-24A	Bar end and screws	24.00
FP-30B	Bar only (30")	88.00
FP-40	Wall connection with flange	53.45
FP-48B	Bar only (48")	151.10
FP-SM3	Slide mechanism for 30" adjusting bar B30	75.05
QD	Quick disconnect unit for hand shower units	160.90
SP-4	5' hose and vacuum breaker	47.70
SP-4-6	Hose (6')	73.20
ST-12RV	Vinyl hose (5')	68.40

HANOVER

NO.	PART NAME	LIST
DF-9B	Escutcheon screws	13.90
DF-28-LAM	Decorative handle kit (w/chrome insert)	87.80
LN-112	Lever handle collar (2 required)	ea. 11.95
LN-114-LAM-KIT	Handle kit	62.85
T-19/20-PL	Dome cover	59.25
T-30C	Diverter/volume handle (tub/shower)	24.15
T-169	7.5 brass escutcheon with screw	75.75
T-169A	Escutcheon ("S" Series)	94.80

**HYDAPIPE 800 Series
Pressure Balancing Valve from 1964 to Date
for valve parts see Safetymix**

NO.	PART NAME	LIST
HP-4	Top cap	64.20
HP-5	Soap dish	97.75
HP-6	Dial	25.75
HP-7	Screws (8 required per unit)	ea. 2.75
HP-10	Body cover	29.75
HP-10A	O-ring	2.90
HP-14	Screw	4.50
HP-14B	Anchor (blue) for Hydapipe	2.75
HP-27	Ceiling flange	81.80
HP-29	Inside joining bracket	81.80
HY-50	Holt head screwdriver	31.55
SC-13C	Dial	23.85
SC-15A	Set screw	3.95

**HYDAPIPE 900 Series
Pressure Balancing Valve from 1997 to Date
for valve parts see Temptrol**

NO.	PART NAME	LIST
HP-7	Screws (8 required per unit)	ea. 2.75
HP-14B	Anchor (blue) for Hydapipe	2.75
HPN-5	Top cap	64.20
HPN-7	Dial	24.30
HPN-10	Dome cover	29.75
HPN-29	Inside joining bracket	164.70
HPN-39	Ceiling flange	81.80
HY-50	Holt head screwdriver	31.55
LM-26SW	Service stop complete	40.25

**H300 Series Hand Spray Units
Prior to May 2013**

NO.	PART NAME	LIST
EF-100	1 mode hand shower wand	119.60
EF-101	3 mode hand shower wand	104.65
EF-104	5' hose and vacuum breaker	110.25
EF-105	Elbow	120.80
EF-106	Wall mounting bracket	32.00
EF-109	Vacuum breaker	58.35
SC-127	5 mode hand shower wand	186.15

**H300 Series Hand Spray Units
May 2013 to Date**

NO.	PART NAME	LIST
EF-100	1 mode hand shower wand	119.60
EF-101	3 mode hand shower wand	104.65
EF-104	5' hose and vacuum breaker	110.25
EF-105	Elbow	120.80
EF-106	Wall mounting bracket	32.00
EF-109	Vacuum breaker	58.35
RA-009	Complete slide assembly	70.75
RA-010	30" bar only	39.60
RA-011	48" bar only	84.90
RA-012	Slide assembly	68.50
RA-013	Mount ends and screws (2)	6.10
RA-016	Slide assembly	141.65

**H400 Series Hand Spray Units
Prior to May 2013**

NO.	PART NAME	LIST
EF-104	5' hose and vacuum breaker	110.25
EF-105	Elbow	120.80
EF-106	Wall mounting bracket	32.00
EF-109	Vacuum breaker	58.35
EF-118	1 mode hand shower wand	211.05
EF-119	3 mode hand shower wand	254.25

H400 Series Hand Spray Units May 2013 to Date		
NO.	PART NAME	LIST
EF-104	5' hose and vacuum breaker	110.25
EF-105	Elbow	120.80
EF-106	Wall mounting bracket	32.00
EF-109	Vacuum breaker	58.35
EF-118	1 mode hand shower wand	211.05
EF-119	3 mode hand shower wand	254.25
RA-009	Complete slide assembly	70.75
RA-010	30" bar only	39.60
RA-011	48" bar only	84.90
RA-012	Slide assembly	68.50
RA-013	Mount ends and screws (2)	6.10

IDENTITY Kitchen Faucets Prior to 2023		
NO.	PART NAME	LIST
RK-050	Handle and screw	32.75
RK-051-1.5	Spray wand	26.35
RK-052	Hose	46.00
RK-053	Mounting hardware	20.65
RK-058	Deck plate	52.85

IDENTITY Lavatory Faucets Prior to 2023		
NO.	PART NAME	LIST
RL-287	Handle with screw set	32.75

IDENTITY COLLECTION Lavatory Faucets 2023 to Date		
NO.	PART NAME	LIST
FLR13605	0.5 gpm (1.9 L/min) faucet aerator	13.70
FLR13610	1.0 gpm (3.8 L/min) faucet aerator	13.70
LN-01449	Kit, handle, with hardware	60.25
KN-113	Cold lavatory faucet replacement cartridge	21.75
KN-114	Hot lavatory faucet replacement cartridge	21.75
RL324	Push-pop drain, brass	39.30
RL326	Widespread faucet spout rough	25.50
RL327	Widespread faucet valve flanges	12.20
RL328	Widespread faucet push-in tee connector	16.65
RL335	Identity widespread faucet handle trim kit	43.65
RL340	Identity widespread faucet spout trim kit	43.05
RL344	Widespread faucet hot valve body	63.70
RL345	Widespread faucet cold valve body	79.50
RL346	Widespread faucet mounting hardware	20.65

LEVERTROL from 1965 to 1976 September 1990 to Date		
NO.	PART NAME	LIST
LD-15A	Escutcheon with set screw	54.80

LLD-20	Replacement unit complete	154.75
RC-14X	Handle	89.65

LEVERTROL 4-458 and 4-459 from 1976 to September 1990		
NO.	PART NAME	LIST
LD-3	Bonnet	31.30
LD-7R	Spindle assembly	77.95
LD-8	Escutcheon nipple	22.95
LD-11	Bonnet o-ring	4.50
LD-12	Bonnet washer	3.95
LD-13	Spring & washer	10.20
LD-15A	Escutcheon with set screw	54.80
RC-14X	Handle	89.65

LEVERTROL 4-460 from 1976 to Date		
NO.	PART NAME	LIST
LD-6A	Bonnet	40.85
LD-7RR	Spindle assembly	84.00
LD-15A	Escutcheon with set screw	54.80
NS-27	Cap large o-ring	3.95

METERING FAUCET SCOT S-60 Series from 1984 to March 2000		
NO.	PART NAME	LIST
K-15P	Handle insert	3.95
LL-1A	Control cartridge	184.55
LL-1B	Control cartridge for quick closing	184.55
LL-27	Handle set screw	3.95
LL-28	Cycle time washers (7)	3.10
LL-35	Thrust washer	3.95
LL-48	Upper housing o-rings (3)	3.95
LL-60B	Aerator, vandal proof	40.10
LL-71B	In-line checks/screen assembly (2)	82.35

METERING FAUCET SCOT S-60 Series April 2000 to Date		
NO.	PART NAME	LIST
LL-1A	Control cartridge	184.55
LL-1B	Control cartridge for quick closing	184.55
LL-3N	Upper housing	24.65
LL-27	Handle set screw	3.95
LL-28	Cycle time washers (7)	3.10
LL-35	Thrust washer	3.95
LL-48	Upper housing o-rings (3)	3.95
LL-71B	In-line checks/screen assembly (2)	82.35
LN-100	0.5 gpm laminar flow vandal resistant aerator kit	17.60
LN-101	Aerator (vandal resistant)	23.40
LT-71B	In-line check/screen assembly	41.40
RL-266	Control spindle kit	107.95
RL-267	Piston spring and cylinder kit	107.95
RL-272	O-ring kit	7.85

**METERING FAUCET
S-70 Series
from 1996 to August 2002**

NO.	PART NAME	LIST
LL-28	Cycle time washers (7)	3.10
LL-60B	Aerator, vandal proof	40.10
LL-60K	Spray outlet wrench	3.95
SPF-26	Hex nut	7.60
SPF-28	Deck plate (S-72 & S-74)	37.75
TT-47N	O-ring	4.50

**METERING FAUCET
S-70 Series
from September 2002 to Date**

NO.	PART NAME	LIST
LL-1A	Control cartridge	184.55
LL-1B	Control cartridge for quick closing	184.55
LL-3N	Upper housing	24.65
LL-27	Handle set screw	3.95
LL-28	Cycle time washers (7)	3.10
LL-48	Upper housing o-rings (3)	3.95
LL-60K	Spray outlet wrench	3.95
LL-101	In-line screen	9.20
LN-100	0.5 gpm laminar flow vandal resistant aerator kit	17.60
LN-101	Aerator (vandal resistant)	23.40
MV-10	Washer (S-73 & S-74)	3.95
MV-107	Repair kit for 4-10 check (2)	10.20
SPF-26	Hex nut	7.60
SPF-28	Deck plate (S-72 & S-74)	37.75
SPF-KIT	Mounting kit (2)	6.65

**METERING FAUCET
SLS-7000 Series**

NO.	PART NAME	LIST
RL-293	Handle kit	65.75
RL-294	4" deck plate	71.40
RL-295	8" deck plate	111.10

**OAK COLLECTION
Lavatory Faucets and Shower Systems**

NO.	PART NAME	LIST
FLR13605	0.5 gpm (1.9 L/min) faucet aerator	13.70
FLR13610	1.0 gpm (5.7 L/min) faucet aerator	13.70
KN-113	Cold lavatory faucet replacement cartridge	16.95
KN-114	Hot lavatory faucet replacement cartridge	16.95
RL-067	Single handle faucet mounting hardware	16.60
RL-082	4" single handle lavatory faucet deck plate	57.25
RL324	Push-pop drain, brass	37.80
RL325	Single handle faucet 25mm cartridge	62.10
RL326	Widespread faucet spout rough	25.50
RL327	Widespread faucet valve flanges	pr. 11.75
RL328	Widespread faucet push in tee connector	16.00

RL344	Widespread faucet hot valve body	76.45
RL345	Widespread faucet cold valve body	76.45
RL355	Oak single handle faucet handle kit	66.40
RL358	Oak widespread faucet spout trim kit	56.20
RL359	Oak widespread faucet handle trim kit	pr. 67.90
RTS152	Square wall elbow	116.15
RTS154	Oak escutcheon kit	128.15
RTS155	Oak VersaFlex escutcheon kit	128.15
RTS156	Oak shower handle	119.00
RTS157	Oak diverter escutcheon kit	241.55
RTS158	Oak diverter lever handle	28.20

**OLDE BRAINTREE BRASS
Pressure Balancing Valve
for valve parts see Temptrol**

NO.	PART NAME	LIST
DF-6	Handle flange	30.35
DF-8	Dial	7.90
DF-9	Escutcheon screws (2)	13.90
DF-10	Handle screw	6.20
DF-11	Dome	68.40
DF-21/22	Diverter/volume handle	77.85
DF-25	O-ring	3.95
DF-28-LAM	Decorative handle kit (w/chrome insert)	87.80
DF-28-LCF	Decorative handle kit (w/clear faceted insert)	87.80
DF-28-LPO	Decorative handle kit (w/white porcelain insert)	87.80
T-127	Chrome cross handle	87.80

**ORIGINS
Centerset Lavatory Faucets (SLC-9612/96103
Prior to 2022**

NO.	PART NAME	LIST
RL-222C	Hot cartridge	64.60
RL-222H	Cold cartridge	64.60
RL-223	Pop-up drain	37.70
RL-224	Pop-up stopper	32.75
RL-239-0.5	0.5 gpm aerator with housing	15.10
RL-239-1.0	1.0 gpm aerator with housing	15.10

**ORIGINS
Single Handle Lavatory Faucets (S-9612/9610)
Prior to 2023**

NO.	PART NAME	LIST
RL-223	Pop-up drain	37.70
RL-224	Pop-up stopper	32.75
RL-226	Handle kit	32.75
RL-227	Cartridge	64.60
RL-228	Mounting hardware	20.65
RL-240-0.5	0.5 gpm aerator with housing	15.10
RL-240-1.0	1.0 gpm aerator with housing	15.10

**ORIGINS
S-243 & S-244 Series Widespread Lavatory Faucets
Prior to 2023**

NO.	PART NAME	LIST
DF-30	Screw (2)	13.25
KN-113	Cold lavatory replacement cartridge	21.75
KN-114	Hot lavatory replacement cartridge	21.75
L-42	Nuts (2)	8.35
LN-100	0.5 gpm laminar flow vandal resistant aerator kit	17.60
LN-101	Aerator (vandal resistant)	23.40
LN-111	Lock ring (2 required)	ea. 4.25
LN-112	Lever handle collar (2 required)	ea. 11.95
LN-121	Phillips pan head screw (2 required)	ea. 3.95
LN-129	Gasket, escutcheon (2 required)	ea. 3.95
LN-131-KIT	Handle kit	29.65
LN-133A	Temperature indicator (red)	3.95
LN-133B	Temperature indicator (blue)	3.95
LN-134	Oval Phillips head screw (2 required)	ea. 3.95
LN-138	Washer	3.95
LN-150	O-ring	3.95
LN-152-LAM-KIT	Handle kit	62.85
LN-152-LPO-KIT	Handle kit	62.85
LN-154	Bushing (2 required)	ea. 3.95
LN-157	Flex hose (2 required)	ea. 21.15
LN-177	Cross handle for lavatory faucets (2 required)	ea. 27.05
P-26	Grid drain assembly	39.75
SPF-26	Hex nut	7.60
T-33	Plug button	3.95
T-33B	Plug button (blue)	4.25
T-33R	Plug button (red)	4.25

**ORIGINS
Tub/Shower**

NO.	PART NAME	LIST
9600-OP-ESC	Escutcheon kit	99.35
9600-P-B-ESC	Brass escutcheon kit	60.90
9600-P-ESC	Escutcheon kit	29.20
9600-PLR-B-ESC	Brass escutcheon kit	60.90
9600-PLR-ESC	Escutcheon kit	29.20
RTS-061	Tri-star handle	28.30
RTS-063	Metal lever handle	76.70
S-9600-OP-ESC	Escutcheon kit for lever handle	110.75
S-9600-P-ESC	Escutcheon kit	76.10
S-9600-PLR-ESC	Escutcheon kit	76.10
S-9600TS-OP-ESC	Escutcheon kit for lever handle	110.75
S-9600TS-P-B-ESC	Brass escutcheon kit	107.70
S-9600TS-P-ESC	Escutcheon kit	76.10
S-9600TS-PLR-B-ESC	Brass escutcheon kit	107.70
S-9600TS-PLR-ESC	Escutcheon kit	76.10
T-19/20	Plastic dome cover and metal lock nut	24.65

**ORIGINS
S-23 Series Kitchen Faucets
Prior to 2023**

NO.	PART NAME	LIST
K-41/42	Hand spray with hose and holder	100.70
K-44	Retainer ring for S-23 Series	4.65
K-46	Diverter o-ring	3.95
KN-1	Valve cap	34.60
KN-2	Compression ring	3.95
KN-3RB	Solid handle	34.20
KN-4	Cartridge	66.20
KN-19A	Spacer	3.95
KN-20	O-ring (2)	5.90
KN-30	Escutcheon	35.35
KN-33	Base plate	10.50
KN-43	Diverter with o-ring (before 12/99)	14.45
KN-118	Gasket	3.95
KN-157	Plug button	3.95
KN-169	Diverter kit (after 8/02)	22.45
L-22	Handle screw	3.95
L-36	Mounting nuts (2)	3.95
L-42	Nuts (2)	8.35
LN-15	2.2 gpm aerator	16.35
LN-34	Cartridge wrench	7.80
LN-100	0.5 gpm laminar flow vandal resistant aerator kit	17.60
LN-101	Aerator (vandal resistant)	23.40
LN-135	6" lever handle	44.25

**ORIGINS
S-248 Series Kitchen Faucets**

NO.	PART NAME	LIST
DF-30	Screw (2)	13.25
K-41/42	Hand spray with hose and holder	100.70
KN-101	Spout assembly	60.30
KN-103	Cap	11.25
KN-104	Spacer	3.95
KN-108	Escutcheon	23.70
KN-109	Base plate	5.30
KN-113	Cold lavatory replacement cartridge	21.75
KN-114	Hot lavatory replacement cartridge	21.75
KN-115	Spacer (2 required)	ea. 3.95
KN-120	O-ring	3.95
L-42	Nuts (2)	8.35
LN-15	2.2 gpm aerator	16.35
LN-101	Aerator (vandal resistant)	23.40
LN-102	Acrylic handle (2 required)	ea. 11.50
LN-102-KIT	Handle kit	17.05
LN-111	Lock ring (2 required)	ea. 4.25
LN-112	Lever handle collar (2 required)	ea. 11.95
LN-121	Phillips pan head screw (2 required)	ea. 3.95
LN-131-KIT	Handle kit	29.65
LN-133A	Temperature indicator (red)	3.95
LN-133B	Temperature indicator (blue)	3.95

LN-134	Oval Phillips head screw (2 required)	ea. 3.95
LN-140	Lever handle (2 required)	ea. 11.50
LN-140-KIT	Handle kit	17.05
LN-152-LAM-KIT	Handle kit	62.85
LN-152-LPO-KIT	Handle kit	62.85
S-240-KIT	Mounting hardware kit (2)	7.20
T-33	Plug button	3.95
T-33B	Plug button (blue)	4.25
T-33R	Plug button (red)	4.25

**SAFETYMIX
Pressure Balancing Mixing Valve
from 1960 to date**

NO.	PART NAME	LIST
C-5	Flow control spindle	151.25
C-50	Renewable seat socket wrench (for all Safetymix models)	112.35
KIT-B	Safetymix washer & gasket kit	24.60
RC-14	Solid lever handle	86.15
SC-2	Cap	97.95
SC-3	Renewable seat w/gaskets	80.75
SC-7	Packing nut	12.45
SC-13/18	Dome cover	34.50
SC-15A	Set screw	3.95
SC-17	Packing (2)	8.35
SC-26	Limit stop with o-ring	7.40

REPAIR KITS

NO.	PART NAME	LIST
FF-1A	Front insert (complete for 4-295)	139.40
FF-2B	Washer	3.95
IH-EX	4-295 adapter for male head	58.35
NIH-1F	GPM floW restrictor and retainer	24.30
NIH-5	Face plate (4-150)	10.05
RK-044	Spray wand	127.35
RO-001	.35 gpm aerator	15.10
RO-004	Wall elbow with backflow prevention	63.15
RO-008	1.0 gpm Tom Junior cache aerator	15.10
RO-010	Face and gasket	106.60
RO-011	1.5 gpm aerator	15.10
RO-011-0.5	0.5 gpm aerator	15.10
RO-019	1.5 gpm G-US aerator	15.10

**SAFETYMIX DIVERTERS
Pushbutton Type
from 1960 to 1964**

NO.	PART NAME	LIST
DT-20/5	Replacement unit complete with escutcheon	221.30

**SAFETYMIX VALVE INTEGRAL STOP W/O-RINGS
1956 to Date or
SAFETYMIX'ETTE' STOP
1964 to 1965**

NO.	PART NAME	LIST
C-32-5	Spindle assembly (5/8" dia.) (2)	46.50

C-32-11	Spindle assembly (11/16" dia.) (2)	46.50
C-32B-11	Plaster shield (11/16" dia.) (2)	8.00

**SCOT
SLC-6000 Series**

NO.	PART NAME	LIST
RL-290	Handle kit	65.75
RL-291	8" deck plate for SLC-6000	111.10

**SENSOR FAUCETS
S-6060 Series**

NO.	PART NAME	LIST
SF-246	Sensor for 6V battery, S-6060	300.75
SF-01804	Sensor, AC, S-6060, Plastic	300.75

SERENO

NO.	PART NAME	LIST
LN-341	Lift rod (lav faucet)	9.10
LN-969	Control cartridge (lav faucet)	59.25
RL-144	Handle kit (lav faucet)	32.75
T-19/20-PL	Dome cover	59.25
T-249	Escutcheon	227.65
T-251	Handle kit (tub/shower)	193.00

**SERENO
Kitchen Faucets**

NO.	PART NAME	LIST
RK-008	Mounting hardware	20.65
RK-009	Handle kit	32.75
RK-011	Hose	12.40
RK-012	Deck plate	75.20
RK-021	Hose	46.00

**SHOWEROFF "60"
Automatic Shower Limiting Valve
from 1960 to 1982**

NO.	PART NAME	LIST
NS-4	Push rod	8.00
NS-22	Escutcheon screws (2)	5.25
PS-1	Complete cartridge replacement unit; includes cap, nut, gaskets, o-ring, washer, screw	341.60
PS-2	Knob & screw	50.40
PS-7	Cap screws (2 required)	pr. 3.95

**SHOWEROFF "83"
Automatic Shower Limiting Valve
from 1983 to Date**

NO.	PART NAME	LIST
HV-1	Manual shut-off cartridge	341.60
L-39	Plug button	3.95
NS-1	Complete cartridge replacement unit	326.60
NS-2	Cap	57.60
NS-3	Knob	21.05
NS-4	Push rod	8.00
NS-5	Guide nut	12.95

NS-6	Cylinder	36.85
NS-7	Retainer	13.05
NS-8	Piston	47.70
NS-9	Retainer	12.80
NS-11	Shut-off washer	3.95
NS-13	Piston spring	4.50
NS-13R	Washer and gasket repair unit	101.20
NS-14	Guide nut washer	3.95
NS-15	Piston o-ring	3.95
NS-16	Control rod	6.35
NS-18	Integral stop unit	23.55
NS-22	Escutcheon screws (2)	5.25
NS-24	Guide nut small o-ring	3.95
NS-25	Guide nut large o-ring	3.95
NS-26	Cap small o-ring	3.95
NS-27	Cap large o-ring	3.95
NS-28	Knob set screw	3.95
NS-30	Adapter plate	15.30
NS-32	Stop retainer	5.25
PS-4A	Escutcheon for 4-427R and 4-428-R	138.15
PS-4E	Studs and nut kit (2)	3.95
PS-4H	Horseshoe bracket	40.75

SOLARITY COLLECTION Lavatory Faucets and Shower Systems

NO.	PART NAME	LIST
FLR13605	0.5 gpm (1.9 L/min) faucet aerator	15.70
FLR13610	1.0 gpm (3.8 L/min) faucet aerator	15.70
KN-113	Cold lavatory faucet replacement cartridge	21.75
KN-114	Hot lavatory faucet replacement cartridge	21.75
RL-067	Single handle faucet mounting hardware	18.35
RL324	Push-pop drain, brass	39.30
RL326	Widespread faucet spout rough	25.50
RL327	Widespread faucet valve flanges	12.20
RL328	Widespread faucet push-in tee connector	16.65
RL344	Widespread faucet hot valve body	79.50
RL354	Widespread faucet cold valve body	63.70
RL369	Solarity single handle faucet handle kit	46.35
RL370	Solarity widespread faucet spout trim kit	43.05
RL371	Solarity widespread faucet handle trim kit	43.65
RTS174	Solarity shower handle	46.35
RTS175	Solarity escutcheon kit	88.70
RTS176	Solarity VersaFlex escutcheon kit	88.70
RTS177	Solarity diverter escutcheon kit	88.05
RTS178	Solarity diverter lever handle	25.50

SYMMETRIX S-20 Series Lavatory Faucets

NO.	PART NAME	LIST
KN-2	Compression ring	3.95
KN-3RB	Solid handle	34.20
KN-4	Cartridge	66.20

KN-157	Plug button	3.95
L-22	Handle screw	3.95
L-36	Mounting nuts (2)	3.95
L-39	Plug button	3.95
L-42	Nuts (2)	8.35
LN-8	Valve cap	25.60
LN-15	2.2 gpm aerator	16.35
LN-20	Gasket	3.95
LN-34	Cartridge wrench	7.80
LN-100	0.5 gpm laminar flow vandal resistant aerator kit	17.60
LN-101	Aerator (vandal resistant)	23.40
LN-135	6" lever handle	44.25
P-26	Grid drain assembly	39.75
SPF-KIT	Mounting kit (2)	6.65
T-33	Plug button	3.95

SYMMETRIX S-26 Series Pull-Out Kitchen Faucets

NO.	PART NAME	LIST
KN-4	Cartridge	66.20
KN-135	Pull-out hose	54.20
KN-136	Hand spray	130.50
KN-157	Plug button	3.95
LN-135	6" lever handle	44.25

SYMMETRIX S-240 Series Lavatory Faucets

NO.	PART NAME	LIST
DF-30	Screw (2)	13.25
KN-113	Cold lavatory replacement cartridge	21.75
KN-114	Hot lavatory replacement cartridge	21.75
KN-116	Flange nut (2 required)	ea. 3.95
L-42	Nuts (2)	8.35
LN-15	2.2 gpm aerator	16.35
LN-20	Gasket	3.95
LN-100	0.5 gpm laminar flow vandal resistant aerator kit	17.60
LN-101	Aerator (vandal resistant)	23.40
LN-102-KIT	Handle kit	17.05
LN-111	Lock ring (2 required)	ea. 4.25
LN-112	Lever handle collar (2 required)	ea. 11.95
LN-114	Handle lever	13.20
LN-114-LAM-KIT	Handle kit	62.85
LN-115	Bushing	3.95
LN-121	Phillips pan head screw (2 required)	ea. 3.95
LN-131-KIT	Handle kit	29.65
LN-133A	Temperature indicator (red)	3.95
LN-133B	Temperature indicator (blue)	3.95
LN-134	Oval Phillips head screw (2 required)	ea. 3.95
LN-140-KIT	Handle kit	17.05
P-26	Grid drain assembly	39.75
S-240-KIT	Mounting hardware kit (2)	7.20
T-33	Plug button	3.95
T-33B	Plug button (blue)	4.25

T-33R	Plug button (red)	4.25
-------	-------------------	------

SYMMETRIX S-245 and S-249 Series Bar and Laundry Faucets

NO.	PART NAME	LIST
DF-30	Screw (2)	13.25
KN-113	Cold lavatory replacement cartridge	21.75
KN-114	Hot lavatory replacement cartridge	21.75
KN-116	Flange nut (2 required)	ea. 3.95
L-5	Aerator	7.05
L-5VP	Vandal resistant aerator	23.40
L-42	Nuts (2)	8.35
LN-20	Gasket	3.95
LN-102	Acrylic handle (2 required)	ea. 11.50
LN-102-KIT	Handle kit	17.05
LN-111	Lock ring (2 required)	ea. 4.25
LN-112	Lever handle collar (2 required)	ea. 11.95
LN-115	Bushing	3.95
LN-121	Phillips pan head screw (2 required)	ea. 3.95
LN-131-KIT	Handle kit	29.65
LN-133A	Temperature indicator (red)	3.95
LN-133B	Temperature indicator (blue)	3.95
LN-134	Oval Phillips head screw (2 required)	ea. 3.95
LN-140	Lever handle (2 required)	ea. 11.50
LN-140-KIT	Handle kit	17.05
LN-147B	Snap ring	5.65
LN-152-LAM-KIT	Handle kit	62.85
LN-152-LPO-KIT	Handle kit	62.85
S-240-KIT	Mounting hardware kit (2)	7.20
T-33	Plug button	3.95
T-33B	Plug button (blue)	4.25
T-33R	Plug button (red)	4.25

SYMMETRIX S-246 Roman Tub Faucets

NO.	PART NAME	LIST
KN-113	Cold lavatory replacement cartridge	21.75
KN-114	Hot lavatory replacement cartridge	21.75
LN-112	Lever handle collar (2 required)	ea. 11.95
LN-129	Gasket, escutcheon (2 required)	ea. 3.95
LN-134	Oval Phillips head screw (2 required)	ea. 3.95
LN-152	Handle lever	17.05
LN-152-LAM-KIT	Handle kit	62.85
LN-152-LPO-KIT	Handle kit	62.85
RT-106	Aerator	12.45
RT-107	Gasket, spout	4.15
SC-15A	Set screw	3.95
T-33	Plug button	3.95
T-33B	Plug button (blue)	4.25
T-33R	Plug button (red)	4.25

SYMMETRIX S-2610 Series Pull-Out Kitchen Faucets

NO.	PART NAME	LIST
KN-4	Cartridge	66.20
KN-191	Cradle	6.55
KN-196	Hand spray	62.85
KN-205	Hose	73.40

TEMPCONTROL Thermostatic Water Controller

NO.	PART NAME	LIST
TT-11-200	Casing gasket	11.20
TT-11-400	Casing gasket	11.20
TT-11-1000	Casing gasket	11.20
TT-15-200	Sleeve o-rings (3)	14.45
TT-15-400	Sleeve o-rings (3)	14.45
TT-15-1000	Sleeve o-rings (3)	16.30
TT-16-100	Spring with spring saddle	15.90
TT-16-200	Spring with spring saddle	15.95
TT-16-400	Spring with spring saddle	15.95
TT-16-500	Spring with spring saddle	15.95
TT-16-700	Spring with spring saddle	15.95
TT-16-900	Double spring with spring saddle	23.70
TT-16-1000	Double spring with spring saddle	23.70
TT-17N-200	Check spring retainer (2)	14.25
TT-17N-400	Check spring retainer	14.25
TT-17N-500	Check spring retainer	14.25
TT-19-400	Gland nut & packing	23.70
TT-19-500	Gland nut & packing (2)	23.70
TT-19-700	Gland nut & packing (2)	23.70
TT-19-900	Gland nut & packing (2)	23.70
TT-20-1000	Cap (2)	205.70
TT-20N-200	Cap (2) for 7 Series only	109.45
TT-20N-400	Cap for 7 Series only	138.05
TT-20N-500	Cap for 7 Series only	205.70
TT-20N-700	Cap for 7 Series only	205.70
TT-21-200	Cap gasket (2)	3.95
TT-21-400	Cap gasket (2)	3.95
TT-21-500	Cap gasket (2)	4.15
TT-21-700	Cap gasket (2)	4.15
TT-21-900	Cap gasket (2)	4.75
TT-21-1000	Cap gasket (2)	4.75
TT-22-900	Stop spindle	56.75
TT-22-1000	Stop spindle	56.75
TT-22N-200	Stop spindle (2)	28.20
TT-22N-400	Stop spindle (2)	28.20
TT-22N-500	Stop spindle (2)	28.20
TT-22N-700	Stop spindle (2)	28.20
TT-26-200	Check seat (2)	69.05
TT-26-400	Check seat (2)	69.05
TT-26-500	Check seat (2)	108.45
TT-26-700	Check seat (2)	108.45
TT-27-900	Check stop body (2)	755.55
TT-27-1000	Check stop body (2)	755.55

TT-32A	Gasket between stops (for 7-900 and 7-1000 Series) (2)	4.65
TT-47N	O-ring (2)	4.50
TT-50AN-200	Complete stop assembly (2)	237.35
TT-50AN-400	Complete stop assembly (2)	302.55
TT-50AN-500	Complete stop assembly (2)	349.50
TT-50AN-700	Complete stop assembly (2)	349.50
TT-181-200	Check spindle and spring (2)	82.90
TT-181-400	Check spindle and spring (2)	108.45
TT-181-500	Check spindle and spring (2)	108.45
TT-181-700	Check spindle and spring (2)	108.45
TT-200-900	Check spindle assembly	114.20
TT-200-1000	Check spindle assembly	114.20

TEMPCONTROL 5-102 to 7-102 Series Thermostatic Water Controller

NO.	PART NAME	LIST
CE-29	O-ring	6.00
CE-30	Gasket (2)	6.00
CSE-25	Check stop body with stop seat (2)	172.65
CSE-26	Check stop cap	88.50
CSE-31	Washer (2)	3.95
CSE-32	Check stop washer (2)	3.95
CSE-35	Check stop spindle (2)	52.30
RO-017	7 Series set screw kit	15.10
RO-028	Nut and bolt for Tempcontrol	15.10

TEMPTROL Pressure Balancing Valve from 1968 to Date

NO.	PART NAME	LIST
T-12A	Cap assembly	65.20
T-16	O-ring, packing and washer	6.00
T-17	Packing nut	12.70
T-19/20	Plastic dome cover and metal lock nut	24.65
T-21	Hold down washer w/screw (1 hole)	3.95
T-21A	Hold down washer w/screws (2 holes)	3.95
T-21C	Diverter retainer	3.95
T-24	Spindle o-ring	3.95
T-27	Escutcheon	52.10
T-27B	Escutcheon gasket	3.95
T-27CL	Diverter handle retainer clip	3.95
T-28	Escutcheon screws 1 1/2" (2)	3.95
T-28A	Escutcheon screws 3" (2)	5.90
T-28VP	Vandal resistant escutcheon screws (2)	6.15
T-29A	Dial (Model A)	10.65
T-29B	Dial (Model B)	10.65
T-29C	Dial (Model C)	10.65
T-30	Diverter/volume handle	19.30
T-31	Handle, plastic	Use RTS-061
T-32	Handle screw and lock washer	3.95
T-33	Plug button	3.95
T-34	Limit stop screw w/o-ring	7.40
T35C	Universal seat removal tool	35.80
T-101	Handle, acrylic	39.95

T-169	7.5 brass escutcheon with screw	75.75
TA-4	Hot & cold renewable seats	62.95
TA-9	Washer replacement kit	9.25
TA-10	Flow control spindle	103.80
TA-10-EXT-KIT	Spindle extension kit	55.35
TA-25A	Diverter/volume spindle (Model A valve) color grey or beige	14.10
TA-25B	Volume spindle (Model B valve) color black	14.10

TEMPTROL Stop Parts for Valves with Sweat Connection

NO.	PART NAME	LIST
T-52	Stop spindle assembly (2)	43.95
T-55	Stop spindle retainer (2)	4.95
T-55C	Stop spindle retainer wrench	34.70

TEMPTROL II Pressure Balancing Valve for valve parts see Temptrol

NO.	PART NAME	LIST
T-27	Escutcheon	52.10
T-28	Escutcheon screws 1 1/2" (2)	3.95
T-29CT2	Dial (for use with T-27)	10.65
T-32	Handle screw and lock washer	3.95
T-33	Plug button	3.95
T-65	Handle kit	31.00

TEMPTROL 2000 Pressure Balancing Valve for valve parts see Temptrol

NO.	PART NAME	LIST
RL-222C	Hot cartridge	64.60
RL-222H	Cold cartridge	64.60
RL-223	Pop-up drain	37.70
RL-224	Pop-up stopper	32.75
RL-226	Handle kit	32.75
T-19/20	Plastic dome cover and metal lock nut	24.65
T-32	Handle screw and lock washer	3.95
T-33	Plug button	3.95
T3-27	Escutcheon (Model C)	52.50
T3-27B	Escutcheon gasket	3.95
T3-28	Escutcheon screws (2)	3.95
T3-29	Dial (Model C)	14.75
T3-31L	Loop handle kit	83.55
T3-31S	Solid handle kit	83.55
T3-31-INS	Handle insert, spline	3.95
T3-33R	Plug button (round)	5.90

ULTRASENSE S-6080 Series Prior to 2011

NO.	PART NAME	LIST
SF-2CR5	6V lithium battery	45.20
SF-125	1.5 gpm aerator vandal resistant aerator kit	37.65
SF-138	Deck plate	71.40

SF-140	Gasket	15.10
SF-142	Mounting kit (2)	15.10
SF-146	Check strainer repair kit (2)	37.65
SF-148	Supply hose	46.00
SF-150A	Pilot valve repair kit	172.45
SF-151	Solenoid valve membrane	15.10
SF-152	Housing screw	15.10
SF-154	Handle	46.00
SF-155	Handle screw	15.10
SF-157	O-ring kit for S-6080	15.10
SF-158	Single mount kit	15.10
SF-159	Plug	7.55
SF-162	Mixer	49.70
SF-173	8" deck plate	111.10
SF-186	Check strainer kit (2)	68.95

ULTRASENSE S-6080 Series 2011 to Date

NO.	PART NAME	LIST
LN-100	0.5 gpm laminar flow vandal resistant aerator kit	17.60
LN-217	1.5 gpm laminar flow vandal resistant aerator kit	31.55
SF-103	Sensor battery box	22.55
SF-125	1.5 gpm aerator vandal resistant aerator kit	37.65
SF-158	Single mount kit	15.10
SF-186	Check strainer kit (2)	68.95
SF-195	AC sensor	496.30
SF-239	Sensor for S-6080-AC-12V	300.75
SF-240	Solenoid	206.85
SF-241	Battery container	22.55
SF-245	Sensor kit	275.70
SF-193	10' (3048mm) output cord	82.75
SF-223	4" deck plate kit	71.40
SF-236	Transformer, 12V, AC, plug in	150.45
SF-01530	Sensor for 6V battery	496.30
SF-01531	Sensor, AC, 12V	300.75
SF-01538	1.5 gpm aerator	37.65

UNITY Centerset Lavatory Faucets (SLC-6612/6610)

NO.	PART NAME	LIST
FLR-102-0.5	0.5 gpm aerator and key	7.50
LN-742-KIT	1.0 gpm aerator and key	15.70
RL-075	Hot cartridge	64.60
RL-076	Cold cartridge	64.60
RL-223	Pop-up drain	37.70
RL-224	Pop-up stopper	32.75

UNITY Single Handle Lavatory Faucets (S-6612/6610)

NO.	PART NAME	LIST
KN-4	Cartridge	66.20
RL-223	Pop-up drain	37.70
RL-224	Pop-up stopper	32.75

UNITY Tub/Shower

NO.	PART NAME	LIST
96-66-DIV-ESC	Escutcheon kit	95.95
T-19/20	Plastic dome cover and metal lock nut	24.65

UNITY Widespread Lavatory Faucets (SLW-6612/6610)

NO.	PART NAME	LIST
FLR-102-0.5	0.5 gpm aerator and key	7.50
LN-742-KIT	1.0 gpm aerator and key	15.70
RL-075	Hot cartridge	64.60
RL-076	Cold cartridge	64.60
RL-223	Pop-up drain	37.70
RL-224	Pop-up stopper	32.75

VERITY COLLECTION Lavatory Faucets and Shower Systems

NO.	PART NAME	LIST
FLR13710	1.0 gpm (5.7 L/min) single handle faucet aerator	13.70
FLR13605	0.5 gpm (1.9 L/min) widespread faucet aerator	13.70
FLR13610	1.0 gpm (3.8 L/min) widespread faucet aerator	13.70
KN-113	Cold lavatory faucet replacement cartridge	16.95
KN-114	Hot lavatory faucet replacement cartridge	16.95
RL-067	Single handle faucet mounting hardware	16.60
RL324	Push-pop drain, brass	37.80
RL326	Widespread faucet spout rough	25.50
RL327	Widespread faucet valve flanges	pr. 11.75
RL328	Widespread faucet push-in tee connector	16.00
RL346	Widespread faucet mounting hardware	19.85
RL349	Verity single handle faucet handle kit	46.35
RL353	Verity widespread faucet handle trim kit	pr. 33.95
RL354	Verity widespread faucet spout trim kit	55.40
RA-009	Wall elbow	56.70
RTS-004	Verity diverter lever	25.50
RTS-044	Verity escutcheon kit	88.70
RTS149	Verity shower handle	57.95
RTS150	Verity VF escutcheon kit	110.10
RTS153	Verity diverter escutcheon kit	110.10

VISU-TEMP Pressure Balancing Valve with Thermometer from 1975 to Date

NO.	PART NAME	LIST
C-5	Flow control spindle	151.25
C-50	Renewable seat socket wrench (for all Safetymix models)	112.35
RC-14	Solid lever handle	86.15
SC-2	Cap	97.95
SC-3	Renewable seat w/gaskets	80.75
SC-7	Packing nut	12.45

SC-10A	Washer screw	Use KIT-B-VT
SC-13/18	Dome cover	34.50
SC-15A	Set screw	3.95
SC-17	Packing (2)	8.35
SC-19	Cap gasket	Use KIT-B-VT
SC-26	Limit stop with o-ring	7.40
VT-9A	Retainer assembly	13.50

VISU-TEMP Pressure Balancing Valve with Thermometer

NO.	PART NAME	LIST
SC-13/18	Dome cover	34.50
VT-103	Thermometer	225.75
VT-105	Escutcheon kit	83.80
VT-112	Handle	96.20
VT-112X	Handle (for separate diverter)	96.20
WO-20A	Screws (2)	3.95

WATER DANCE Pressure Balancing Valve

NO.	PART NAME	LIST
C-13	Dome cover	45.95
DF-9	Escutcheon screws (2)	13.90
DF-10	Handle screw	6.20
DF-25	O-ring	3.95
HF-103	Spindle	226.15
HF-109	Renewable seat w/gasket	119.00
HF-113	Dome cover	24.15
KIT-HF	Washer and gasket kit	42.60
SC-2	Cap	97.95
SC-7	Packing nut	12.45
SC-10A	Hot washer screw	Use KIT-HF
SC-10/11	Hot & cold washers	Use KIT-HF
SC-17	Packing (2)	8.35
SC-19	Cap gasket	Use KIT-HF
SC-26	Limit stop with o-ring	7.40
T-32	Handle screw and lock washer	3.95
T-33	Plug button	3.95
T3-28	Escutcheon screws (2)	3.95
T3-31L	Loop handle kit	83.55
T3-31S	Solid handle kit	83.55

W-400, W-500-B, W-600, W-602 Duplex Protector Valve for Washing Machine Supplies

NO.	PART NAME	LIST
KIT-AA	Rebuilding unit for all models of washing machine valves. (Includes valve, handle and mounting gaskets)	66.45
KIT-W-400	Hardware and gasket kit	22.50
KIT-W-600	Hardware and gasket kit	22.50
KIT-W-602	Hardware and gasket kit	22.50
KIT-WM	Pistons and o-rings for valve (for valves mfgd. after 1984)	32.70
LM-1	Box for W-600	34.70
LM-2	Cover	32.55

LM-3A	Drip pan	17.05
LM-5	Handle	8.80
LM-6/7	Labels	3.95
LM-9	Drain nut for W-602	3.95
LM-12	Screws	3.95
W-2A	Sweat elbow fittings (2)	25.45
W-12	Screws (2)	4.75
W-13	Small gasket (2)	3.95
W-14	Large gasket (2)	3.95
WS-17	Cover with label for W-500-B	7.40
WS-18/19	Handle and knob	13.25

2025 SYMMONS REPAIR PARTS LIST PRICING CA

MAY 22, 2025

Symmons Genuine Repair Parts should be used to repair or service your Symmons product.
Use of replacement parts other than Symmons will void any warranty.

NO.	PART NAME	LIST
430SS	Flange only	8.90
9600-OP-ESC	Escutcheon kit	99.35
9600-P-B-ESC	Brass escutcheon kit	60.90
9600-P-ESC	Escutcheon kit	29.20
9600-PLR-B-ESC	Brass escutcheon kit	60.90
9600-PLR-ESC	Escutcheon kit	29.20
96-66-DIV-ESC	Escutcheon kit	95.95
C-13	Dome cover	45.95
C-32-11	Spindle assembly (11/16" dia.) (2)	46.50
C-32-5	Spindle assembly (5/8" dia.) (2)	46.50
C-32B-11	Plaster shield (11/16" dia.) (2)	8.00
C-5	Flow control spindle	151.25
C-50	Renewable seat socket wrench (for all Safetymix models)	112.35
CE-29	O-ring	6.00
CE-30	Gasket (2)	6.00
CSE-25	Check stop body with stop seat (2)	172.65
CSE-26	Check stop cap	88.50
CSE-31	Washer (2)	3.95
CSE-32	Check stop washer (2)	3.95
CSE-35	Check stop spindle (2)	52.30
DF-10	Handle screw	6.20
DF-11	Dome	68.40
DF-21/22	Diverter/volume handle	77.85
DF-25	O-ring	3.95
DF-28-LAM	Decorative handle kit (w/chrome insert)	87.80
DF-28-LCF	Decorative handle kit (w/clear faceted insert)	87.80
DF-28-LPO	Decorative handle kit (w/white porcelain insert)	87.80
DF-30	Screw (2)	13.25
DF-6	Handle flange	30.35
DF-8	Dial	7.90
DF-9	Escutcheon screws (2)	13.90
DF-9B	Escutcheon screws	13.90
DT-10	Packing cup	3.95
DT-11	O-ring washer	3.95
DT-12	Spring	4.50
DT-13	Volume dial & screw	6.00
DT-15	Knob	20.10
DT-2	Bonnet	38.25
DT-20	Replacement unit complete	166.35
DT-20/5	Replacement unit complete with escutcheon	221.30
DT-3	Spindle assembly	60.40
DT-4	Spacer bushing	11.20
DT-7	Escutcheon bushing	22.40

NO.	PART NAME	LIST
DT-8	Bonnet o-ring	3.95
DT-9	Bonnet gasket	3.95
EF-100	1 mode hand shower wand	119.60
EF-101	3 mode hand shower wand	104.65
EF-104	5' hose and vacuum breaker	110.25
EF-105	Elbow	120.80
EF-106	Wall mounting bracket	32.00
EF-109	Vacuum breaker	58.35
EF-118	1 mode hand shower wand	211.05
EF-119	3 mode hand shower wand	254.25
FF-1A	Front insert (complete for 4-295)	139.40
FF-2B	Washer	3.95
FLR-102-0.5	0.5 gpm aerator and key	7.50
FLR-110-1.0	1.0 gpm aerator	16.75
FLR-110-1.5	1.5 gpm aerator	16.35
FLR13605	0.5 gpm (1.9 L/min) faucet aerator	13.70
FLR13610	1.0 gpm (3.8 L/min) faucet aerator	13.70
FLR13710	1.0 gpm (5.7 L/min) single handle faucet aerator	13.70
FP-1	Open flow hand spray	163.70
FP-1E	Swivel	19.20
FP-1-TEMPTR0L	Temptrol open flow hand spray	54.35
FP-2	Wall bracket with screws	27.15
FP-24A	Bar end and screws	24.00
FP-30B	Bar only (30")	88.00
FP-40	Wall connection with flange	53.45
FP-48B	Bar only (48")	151.10
FP-SM3	Slide mechanism for 30" adjusting bar B30	75.05
HF-103	Spindle	226.15
HF-109	Renewable seat w/gasket	119.00
HF-113	Dome cover	24.15
HP-10	Body cover	29.75
HP-10A	O-ring	2.90
HP-14	Screw	4.50
HP-14B	Anchor (blue) for Hydapipe	2.75
HP-27	Ceiling flange	81.80
HP-29	Inside joining bracket	81.80
HP-4	Top cap	64.20
HP-5	Soap dish	97.75
HP-6	Dial	25.75
HP-7	Screws (8 required per unit)	ea. 2.75
HPN-10	Dome cover	29.75
HPN-29	Inside joining bracket	164.70
HPN-39	Ceiling flange	81.80
HPN-5	Top cap	64.20
HPN-7	Dial	24.30

NO.	PART NAME	LIST
HV-1	Manual shut-off cartridge	341.60
HY-50	Holt head screwdriver	31.55
IH-EX	4-295 adapter for male head	58.35
K-15P	Handle insert	3.95
K-41/42	Hand spray with hose and holder	100.70
K-44	Retainer ring for S-23 Series	4.65
K-46	Diverter o-ring	3.95
KIT-AA	Rebuilding unit for all models of washing machine valves. (Includes valve, handle and mounting gaskets)	66.45
KIT-B	Safetymix washer & gasket kit	24.60
KIT-HF	Washer and gasket kit	42.60
KIT-W-400	Hardware and gasket kit	22.50
KIT-W-600	Hardware and gasket kit	22.50
KIT-W-602	Hardware and gasket kit	22.50
KIT-WM	Pistons and o-rings for valve (for valves mfgd. after 1984)	32.70
KN-1	Valve cap	34.60
KN-101	Spout assembly	60.30
KN-103	Cap	11.25
KN-104	Spacer	3.95
KN-108	Escutcheon	23.70
KN-109	Base plate	5.30
KN-113	Cold lavatory replacement cartridge	21.75
KN-114	Hot lavatory replacement cartridge	21.75
KN-115	Spacer (2 required)	ea. 3.95
KN-116	Flange nut (2 required)	ea. 3.95
KN-118	Gasket	3.95
KN-120	O-ring	3.95
KN-135	Pull-out hose	54.20
KN-136	Hand spray	130.50
KN-157	Plug button	3.95
KN-169	Diverter kit (after 8/02)	22.45
KN-191	Cradle	6.55
KN-196	Hand spray	62.85
KN-19A	Spacer	3.95
KN-2	Compression ring	3.95
KN-20	O-ring (2)	5.90
KN-205	Hose	73.40
KN-30	Escutcheon	35.35
KN-33	Base plate	10.50
KN-3RB	Solid handle	34.20
KN-4	Cartridge	66.20
KN-43	Diverter with o-ring (before 12/99)	14.45
L-22	Handle screw	3.95
L-36	Mounting nuts (2)	3.95
L-39	Plug button	3.95
L-42	Nuts (2)	8.35
L-5	Aerator	7.05
L-5VP	Vandal resistant aerator	23.40
LD-11	Bonnet o-ring	4.50
LD-12	Bonnet washer	3.95
LD-13	Spring & washer	10.20
LD-15A	Escutcheon with set screw	54.80
LD-3	Bonnet	31.30

NO.	PART NAME	LIST
LD-6A	Bonnet	40.85
LD-7R	Spindle assembly	77.95
LD-7RR	Spindle assembly	84.00
LD-8	Escutcheon nipple	22.95
LL-101	In-line screen	9.20
LL-1A	Control cartridge	184.55
LL-1B	Control cartridge for quick closing	184.55
LL-27	Handle set screw	3.95
LL-28	Cycle time washers (7)	3.10
LL-35	Thrust washer	3.95
LL-3N	Upper housing	24.65
LL-48	Upper housing o-rings (3)	3.95
LL-60B	Aerator, vandal proof	40.10
LL-60K	Spray outlet wrench	3.95
LL-71B	In-line checks/screen assembly (2)	82.35
LLD-20	Replacement unit complete	154.75
LM-1	Box for W-600	34.70
LM-12	Screws	3.95
LM-2	Cover	32.55
LM-26SW	Service stop complete	40.25
LM-3A	Drip pan	17.05
LM-5	Handle	8.80
LM-6/7	Labels	3.95
LM-9	Drain nut for W-602	3.95
LN-01416	Single post lavatory handle	67.05
LN-01417	Single post lavatory control cartridge	29.30
LN-01449	Kit, handle, with hardware	60.25
LN-01452	Hot cartridge	27.40
LN-01453	Cold cartridge	27.40
LN-01454	Handle repair kit	58.85
LN-02774	Hot cartridge	27.40
LN-02775	Cold cartridge	27.40
LN-100	0.5 gpm laminar flow vandal resistant aerator kit	17.60
LN-101	Aerator (vandal resistant)	23.40
LN-102	Acrylic handle (2 required)	ea. 11.50
LN-102-KIT	Handle kit	17.05
LN-111	Lock ring (2 required)	ea. 4.25
LN-112	Lever handle collar (2 required)	ea. 11.95
LN-114	Handle lever	13.20
LN-114-LAM-KIT	Handle kit	62.85
LN-115	Bushing	3.95
LN-121	Phillips pan head screw (2 required)	ea. 3.95
LN-129	Gasket, escutcheon (2 required)	ea. 3.95
LN-131-KIT	Handle kit	29.65
LN-133A	Temperature indicator (red)	3.95
LN-133B	Temperature indicator (blue)	3.95
LN-134	Oval Phillips head screw (2 required)	ea. 3.95
LN-135	6" lever handle	44.25
LN-138	Washer	3.95
LN-140	Lever handle (2 required)	ea. 11.50
LN-140-KIT	Handle kit	17.05
LN-147B	Snap ring	5.65
LN-15	2.2 gpm aerator	16.35

NO.	PART NAME	LIST
LN-150	O-ring	3.95
LN-152	Handle lever	17.05
LN-152-LAM-KIT	Handle kit	62.85
LN-152-LPO-KIT	Handle kit	62.85
LN-154	Bushing (2 required)	ea. 3.95
LN-157	Flex hose (2 required)	ea. 21.15
LN-177	Cross handle for lavatory faucets (2 required)	ea. 27.05
LN-20	Gasket	3.95
LN-217	1.5 gpm laminar flow vandal resistant aerator kit	31.55
LN-34	Cartridge wrench	7.80
LN-341	Lift rod (lav faucet)	9.10
LN-742-KIT	1.0 gpm aerator and key	15.70
LN-8	Valve cap	25.60
LN-969	Control cartridge (lav faucet)	59.25
LT-71B	In-line check/screen assembly	41.40
MV-10	Washer (S-73 & S-74)	3.95
MV-107	Repair kit for 4-10 check (2)	10.20
NIH-1F	GPM floW restrictor and retainer	24.30
NIH-5	Face plate (4-150)	10.05
NS-1	Complete cartridge replacement unit	326.60
NS-11	Shut-off washer	3.95
NS-13	Piston spring	4.50
NS-13R	Washer and gasket repair unit	101.20
NS-14	Guide nut washer	3.95
NS-15	Piston o-ring	3.95
NS-16	Control rod	6.35
NS-18	Integral stop unit	23.55
NS-2	Cap	57.60
NS-22	Escutcheon screws (2)	5.25
NS-24	Guide nut small o-ring	3.95
NS-25	Guide nut large o-ring	3.95
NS-26	Cap small o-ring	3.95
NS-27	Cap large o-ring	3.95
NS-28	Knob set screw	3.95
NS-3	Knob	21.05
NS-30	Adapter plate	15.30
NS-32	Stop retainer	5.25
NS-4	Push rod	8.00
NS-5	Guide nut	12.95
NS-6	Cylinder	36.85
NS-7	Retainer	13.05
NS-8	Piston	47.70
NS-9	Retainer	12.80
P-100N	Plastic stopper	8.35
P-26	Grid drain assembly	39.75
PS-1	Complete cartridge replacement unit; includes cap, nut, gaskets, o-ring, washer, screw	341.60
PS-2	Knob & screw	50.40
PS-4A	Escutcheon for 4-427R and 4-428-R	138.15
PS-4E	Studs and nut kit (2)	3.95
PS-4H	Horseshoe bracket	40.75
PS-7	Cap screws (2 required)	pr. 3.95

NO.	PART NAME	LIST
QD	Quick disconnect unit for hand shower units	160.90
RA-009	Complete slide assembly	70.75
RA-010	30" bar only	39.60
RA-011	48" bar only	84.90
RA-012	Slide assembly	68.50
RA-013	Mount ends and screws (2)	6.10
RA-016	Slide assembly	141.65
RC-14	Solid lever handle	86.15
RC-14X	Handle	89.65
RK-001	Mounting hardware	20.65
RK-002	Pull-down handle kit	32.75
RK-003	Cartridge	64.60
RK-004	Spray wand	45.80
RK-005	O-ring and dual check	7.85
RK-006	Hose	12.40
RK-007	Installation tool	7.85
RK-008	Mounting hardware	20.65
RK-009	Handle kit	32.75
RK-011	Hose	12.40
RK-012	Deck plate	75.20
RK-013	Handle assembly	32.75
RK-014	Connector repair kit	15.50
RK-015-1.5	Aerator	15.10
RK-021	Hose	46.00
RK-022	O-ring repair kit for SPP-3510	9.00
RK-024	Mounting hardware	20.65
RK-030	Spray wand	127.35
RK-032	Hose	46.00
RK-032-GY	Hose	46.00
RK-044	Spray wand	127.35
RK-050	Handle and screw	32.75
RK-051-1.5	Spray wand	26.35
RK-052	Hose	46.00
RK-053	Mounting hardware	20.65
RK-058	Deck plate	52.85
RL-002	Widespread lavatory handle kit (with screws) (2)	65.75
RL-003	Widespread lavatory hot cartridge	64.60
RL-004	Widespread lavatory cold cartridge	64.60
RL-006	Widespread lavatory lift rod assembly	18.05
RL-011	Mounting kit and hoses	46.00
RL-014	Lift rod, stopper, ball rod	18.05
RL-015	Lift rod	18.05
RL-019	0.5 gpm aerator	15.10
RL-031	Widespread lavatory handle kit	32.75
RL-032	8" deck plate for SPB-3510	111.10
RL-041	Single post lavatory handle kit	32.75
RL-042	Single post lavatory control cartridge	64.60
RL-057	Widespread lavatory mounting hardware	20.65
RL-058	Widespread lavatory handle kit	65.75
RL-067	Single handle faucet mounting hardware	16.60
RL-068	Single post pop up drain assembly	37.70
RL-071	Single post lavatory 0.5 gpm aerator	15.10

NO.	PART NAME	LIST
RL-072	Repair kit	32.75
RL-075	Hot cartridge	64.60
RL-076	Cold cartridge	64.60
RL-081	4" single handle lavatory faucet deck plate	34.20
RL-082	4" single handle lavatory faucet deck plate	57.25
RL-118	Lift rod	18.05
RL-120	1.5 gpm aerator	15.10
RL-123	Mounting hardware	20.65
RL-144	Handle kit (lav faucet)	32.75
RL-148	Widespread mounting kit	20.65
RL-149	Widespread handle kit	32.75
RL-150	Lift rod	18.05
RL-154LR	Pop up drain, less rod	37.70
RL-179	Centerset handle	65.75
RL-180C	Centerset lavatory cartridge, cold	64.60
RL-180H	Centerset lavatory cartridge, hot	64.60
RL-191	Centerset lift rod	18.05
RL-196	Centerset lavatory 1.0 gpm aerator	15.10
RL-198	Escutcheon kit (2)	32.75
RL-222C	Hot cartridge	64.60
RL-222H	Cold cartridge	64.60
RL-223	Pop-up drain	37.70
RL-224	Pop-up stopper	32.75
RL-226	Handle kit	32.75
RL-227	Cartridge	64.60
RL-228	Mounting hardware	20.65
RL-235	Lift rod for SLC-4712	18.05
RL-238	Mounting hardware kit for SLS-3510	20.65
RL-239-0.5	0.5 gpm aerator with housing	15.10
RL-239-1.0	1.0 gpm aerator with housing	15.10
RL-240-0.5	0.5 gpm aerator with housing	15.10
RL-240-1.0	1.0 gpm aerator with housing	15.10
RL-250	Cross handle kit	65.75
RL-266	Control spindle kit	107.95
RL-267	Piston spring and cylinder kit	107.95
RL-272	O-ring kit	7.85
RL-279	Limit stop cartridge	64.60
RL-287	Handle with screw set	32.75
RL-290	Handle kit	65.75
RL-291	8" deck plate for SLC-6000	111.10
RL-293	Handle kit	65.75
RL-294	4" deck plate	71.40
RL-295	8" deck plate	111.10
RL324	Push-pop drain, brass	37.80
RL325	Single handle faucet 25mm cartridge	62.10
RL326	Widespread faucet spout rough	25.50
RL327	Widespread faucet valve flanges	pr. 12.20
RL328	Widespread faucet push-in tee connector	16.00
RL329	Dia widespread faucet handle trim kit	pr. 52.70
RL330	Dia widespread faucet cross handle trim kit	pr. 52.70
RL332	Elm widespread faucet handle trim kit	pr. 26.35

NO.	PART NAME	LIST
RL335	Dia widespread faucet spout trim kit (SLW3512)	44.95
RL336	Dia widespread faucet spout trim kit (SLW3522)	44.95
RL338	Elm widespread faucet spout trim kit	46.30
RL340	Identity widespread faucet spout trim kit	43.05
RL344	Widespread faucet hot valve body	79.50
RL345	Widespread faucet cold valve body	79.50
RL346	Widespread faucet mounting hardware	20.65
RL349	Verity single handle faucet handle kit	46.35
RL353	Verity widespread faucet handle trim kit	pr. 33.95
RL354	Widespread faucet cold valve body	63.70
RL355	Oak single handle faucet handle kit	66.40
RL356	Birch single handle faucet handle kit	46.35
RL357	Braston single handle faucet handle kit	66.40
RL358	Oak widespread faucet spout trim kit	56.20
RL359	Oak widespread faucet handle trim kit	pr. 67.90
RL360	Birch widespread faucet spout trim kit	55.40
RL361	Birch widespread faucet handle trim kit	pr. 33.95
RL363	Brastson widespread faucet spout trim kit	56.20
RL364	Braston widespread faucet handle trim kit	pr. 67.90
RL365	Duro widespread faucet spout trim kit (SLW3612)	44.95
RL366	Duro widespread faucet spout trim kit (SLW3622)	44.95
RL367	Duro widespread faucet handle trim kit	68.55
RL368	Widespread faucet valve flanges	pr. 12.75
RL369	Solarity single handle faucet handle kit	46.35
RL370	Solarity widespread faucet spout trim kit	43.05
RL371	Solarity widespread faucet handle trim kit	43.65
RO-001	.35 gpm aerator	15.10
RO-004	Wall elbow with backflow prevention	63.15
RO-007	1.5 gpm pull-down aerator	15.10
RO-008	1.0 gpm Tom Junior cache aerator	15.10
RO-010	Face and gasket	106.60
RO-011	1.5 gpm aerator	15.10
RO-011-0.5	0.5 gpm aerator	15.10
RO-017	7 Series set screw kit	15.10
RO-019	1.5 gpm G-US aerator	15.10
RO-028	Nut and bolt for Tempcontrol	15.10
RT-106	Aerator	12.45
RT-107	Gasket, spout	4.15
RTS-001	Model C escutcheon kit (includes mounting hardware and dome cover)	127.85
RTS-003	Model A/B escutcheon kit (includes mounting hardware and dome cover)	127.85
RTS-004	Diverter/Volume control handle	29.20
RTS-005	Escutcheon repair kit (includes mounting hardware and dome cover)	127.85
RTS-006	Tub/shower handle kit	36.40
RTS-007	Escutcheon repair kit (includes mounting hardware and dome cover)	127.85
RTS-008	Diverter/volume control handle	37.75
RTS-009	Model C brass escutcheon kit (includes mounting hardware and dome cover)	127.85

NO.	PART NAME	LIST
RTS-010	Model C plastic escutcheon kit (includes mounting hardware and dome cover)	127.85
RTS-011	Model A/B brass escutcheon kit (includes mounting hardware and dome cover)	127.85
RTS-012	Model A/B plastic escutcheon kit (includes mounting hardware and dome cover)	127.85
RTS-013	Brass diverter/volume control handle	25.75
RTS-014	Plastic diverter/volume control handle	6.20
RTS-026	Shower handle kit	54.15
RTS-032	Allura tub/shower handle kit	37.65
RTS-037	Dome cover repair kit	24.00
RTS-038	Diverter escutcheon kit	127.85
RTS-040	Diverter escutcheon kit	127.85
RTS-041	Shower riser diverter handle	58.10
RTS-042	Riser diverter cartridge	66.20
RTS-043	Shower riser slide assembly	174.15
RTS-044	Verity escutcheon kit	88.70
RTS-061	Tri-star handle	28.30
RTS-063	Metal lever handle	76.70
RTS-090	Shower handle, 3520 series	56.85
RTS-091	Shower handle, 3530 series	56.85
RTS-092	Shower handle, 3620 Series	56.85
RTS-093	Shower handle, 3630 Series	56.85
RTS149	Verity shower handle	57.95
RTS150	Verity VF escutcheon kit	110.10
RTS152	Square wall elbow	116.15
RTS153	Verity diverter escutcheon kit	110.10
RTS154	Oak escutcheon kit	128.15
RTS155	Oak VersaFlex escutcheon kit	128.15
RTS156	Oak shower handle	119.00
RTS157	Oak diverter escutcheon kit	241.55
RTS158	Oak diverter lever handle	28.20
RTS161	Braston escutcheon kit	128.15
RTS162	Braston VersaFlex escutcheon kit	128.15
RTS163	Braston shower handle	119.00
RTS164	Braston diverter escutcheon kit	241.55
RTS165	Braston diverter lever	28.20
RTS168	Birch escutcheon kit	110.90
RTS169	Birch VersaFlex escutcheon kit	110.90
RTS170	Birch shower handle	57.95
RTS171	Birch diverter escutcheon kit	110.10
RTS172	Birch diverter lever handle	28.20
RTS173	Birch wall elbow	118.00
RTS174	Solarity shower handle	46.35
RTS175	Solarity escutcheon kit	88.70
RTS176	Solarity VersaFlex escutcheon kit	88.70
RTS177	Solarity diverter escutcheon kit	88.05
RTS178	Solarity diverter lever handle	25.50
S-240-KIT	Mounting hardware kit (2)	7.20
S-9600-OP-ESC	Escutcheon kit for lever handle	110.75
S-9600-P-ESC	Escutcheon kit	76.10
S-9600-PLR-ESC	Escutcheon kit	76.10
S-9600TS-OP-ESC	Escutcheon kit for lever handle	110.75

NO.	PART NAME	LIST
S-9600TS-P-B-ESC	Brass escutcheon kit	107.70
S-9600TS-P-ESC	Escutcheon kit	76.10
S-9600TS-PLR-B-ESC	Brass escutcheon kit	107.70
S-9600TS-PLR-ESC	Escutcheon kit	76.10
SC-10/11	Hot & cold washers	Use KIT-HF
SC-10A	Washer screw	Use KIT-B-VT
SC-127	5 mode hand shower wand	186.15
SC-13/18	Dome cover	34.50
SC-13C	Dial	23.85
SC-15A	Set screw	3.95
SC-17	Packing (2)	8.35
SC-19	Cap gasket	Use KIT-B-VT
SC-2	Cap	97.95
SC-26	Limit stop with o-ring	7.40
SC-3	Renewable seat w/gaskets	80.75
SC-7	Packing nut	12.45
SD010	Soap Dispenser 12V Transformer (power supply)	19.80
SD017	Extension Cable, 4.5 Feet	23.85
SD019	Power Splitter	27.40
SD021	12V Power Supply 2.5 Amp	91.80
SF-01530	Sensor for 6V battery	496.30
SF-01531	Sensor, AC, 12V	300.75
SF-01538	1.5 gpm aerator	37.65
SF-01804	Sensor, AC, S-6060, Plastic	300.75
SF-103	Sensor battery box	22.55
SF-125	1.5 gpm aerator vandal resistant aerator kit	37.65
SF-138	Deck plate	71.40
SF-140	Gasket	15.10
SF-142	Mounting kit (2)	15.10
SF-146	Check strainer repair kit (2)	37.65
SF-148	Supply hose	46.00
SF-150A	Pilot valve repair kit	172.45
SF-151	Solenoid valve membrane	15.10
SF-152	Housing screw	15.10
SF-154	Handle	46.00
SF-155	Handle screw	15.10
SF-157	O-ring kit for S-6080	15.10
SF-158	Single mount kit	15.10
SF-159	Plug	7.55
SF-162	Mixer	49.70
SF-173	8" deck plate	111.10
SF-186	Check strainer kit (2)	68.95
SF-193	10' (3048mm) output cord	82.75
SF-195	AC sensor	496.30
SF-223	4" deck plate kit	71.40
SF-236	Transformer, 12V, AC, plug in	150.45
SF-239	Sensor for S-6080-AC-12V	300.75
SF-240	Solenoid	206.85
SF-241	Battery container	22.55
SF-245	Sensor kit	275.70
SF-246	Sensor for 6V battery, S-6060	300.75

NO.	PART NAME	LIST
SF251	Sensor Kit (Single)	273.45
SF253	Solenoid Valve (Single)	100.65
SF255	Solenoid Housing Kit (Single)	41.75
SF258	Battery Box (batteries not included)	87.45
SF277	3 Meter Output Cable (Male)	25.50
SF-2CR5	6V lithium battery	45.20
SP-4	5' hose and vacuum breaker	47.70
SP-4-6	Hose (6')	73.20
SPF-26	Hex nut	7.60
SPF-28	Deck plate (S-72 & S-74)	37.75
SPF-KIT	Mounting kit (2)	6.65
ST-12RV	Vinyl hose (5')	68.40
T-101	Handle, acrylic	39.95
T-127	Chrome cross handle	87.80
T-12A	Cap assembly	65.20
T-130A	S-valve tub/shower dial kit	14.15
T-130B	S-valve shower only dial kit	14.15
T-132	Hot/Cold dial (Model C)	9.95
T-133C	Non-S valve escutcheon kit	52.10
T-139	Diverter/volume control handle	21.20
T-16	O-ring, packing and washer	6.00
T-169	7.5 brass escutcheon with screw	75.75
T-169A	Escutcheon ("S" Series)	94.80
T-17	Packing nut	12.70
T-19/20	Plastic dome cover and metal lock nut	24.65
T-19/20-PL	Dome cover	59.25
T-21	Hold down washer w/screw (1 hole)	3.95
T-21A	Hold down washer w/screws (2 holes)	3.95
T-21C	Diverter retainer	3.95
T-24	Spindle o-ring	3.95
T-242A	Tub/shower handle kit	118.90
T-249	Escutcheon	227.65
T-251	Handle kit (tub/shower)	193.00
T-27	Escutcheon	52.10
T-27B	Escutcheon gasket	3.95
T-27CL	Diverter handle retainer clip	3.95
T-28	Escutcheon screws 1 1/2" (2)	3.95
T-28A	Escutcheon screws 3" (2)	5.90
T-28VP	Vandal resistant escutcheon screws (2)	6.15
T-29A	Dial (Model A)	10.65
T-29B	Dial (Model B)	10.65
T-29C	Dial (Model C)	10.65
T-29CT2	Dial (for use with T-27)	10.65
T-30	Diverter/volume handle	19.30
T-30C	Diverter/volume handle (tub/shower)	24.15
T-31	Handle, plastic	Use RTS-061
T-32	Handle screw and lock washer	3.95
T3-27	Escutcheon (Model C)	52.50
T3-27B	Escutcheon gasket	3.95
T3-28	Escutcheon screws (2)	3.95
T3-29	Dial (Model C)	14.75
T-33	Plug button	3.95
T3-31-INS	Handle insert, spline	3.95

NO.	PART NAME	LIST
T3-31L	Loop handle kit	83.55
T3-31S	Solid handle kit	83.55
T3-33R	Plug button (round)	5.90
T-33B	Plug button (blue)	4.25
T-33R	Plug button (red)	4.25
T-34	Limit stop screw w/o-ring	7.40
T35C	Universal seat removal tool	35.80
T-52	Stop spindle assembly (2)	43.95
T-55	Stop spindle retainer (2)	4.95
T-55C	Stop spindle retainer wrench	34.70
T-65	Handle kit	31.00
TA-10	Flow control spindle	103.80
TA-10-EXT-KIT	Spindle extension kit	55.35
TA-25A	Diverter/volume spindle (Model A valve) color grey or beige	14.10
TA-25B	Volume spindle (Model B valve) color black	14.10
TA-4	Hot & cold renewable seats	62.95
TA-9	Washer replacement kit	9.25
TT-11-1000	Casing gasket	11.20
TT-11-200	Casing gasket	11.20
TT-11-400	Casing gasket	11.20
TT-15-1000	Sleeve o-rings (3)	16.30
TT-15-200	Sleeve o-rings (3)	14.45
TT-15-400	Sleeve o-rings (3)	14.45
TT-16-100	Spring with spring saddle	15.90
TT-16-1000	Double spring with spring saddle	23.70
TT-16-200	Spring with spring saddle	15.95
TT-16-400	Spring with spring saddle	15.95
TT-16-500	Spring with spring saddle	15.95
TT-16-700	Spring with spring saddle	15.95
TT-16-900	Double spring with spring saddle	23.70
TT-17N-200	Check spring retainer (2)	14.25
TT-17N-400	Check spring retainer	14.25
TT-17N-500	Check spring retainer	14.25
TT-181-200	Check spindle and spring (2)	82.90
TT-181-400	Check spindle and spring (2)	108.45
TT-181-500	Check spindle and spring (2)	108.45
TT-181-700	Check spindle and spring (2)	108.45
TT-19-400	Gland nut & packing	23.70
TT-19-500	Gland nut & packing (2)	23.70
TT-19-700	Gland nut & packing (2)	23.70
TT-19-900	Gland nut & packing (2)	23.70
TT-200-1000	Check spindle assembly	114.20
TT-200-900	Check spindle assembly	114.20
TT-20-1000	Cap (2)	205.70
TT-20N-200	Cap (2) for 7 Series only	109.45
TT-20N-400	Cap for 7 Series only	138.05
TT-20N-500	Cap for 7 Series only	205.70
TT-20N-700	Cap for 7 Series only	205.70
TT-21-1000	Cap gasket (2)	4.75
TT-21-200	Cap gasket (2)	3.95
TT-21-400	Cap gasket (2)	3.95
TT-21-500	Cap gasket (2)	4.15

NO.	PART NAME	LIST
TT-21-700	Cap gasket (2)	4.15
TT-21-900	Cap gasket (2)	4.75
TT-22-1000	Stop spindle	56.75
TT-22-900	Stop spindle	56.75
TT-22N-200	Stop spindle (2)	28.20
TT-22N-400	Stop spindle (2)	28.20
TT-22N-500	Stop spindle (2)	28.20
TT-22N-700	Stop spindle (2)	28.20
TT-26-200	Check seat (2)	69.05
TT-26-400	Check seat (2)	69.05
TT-26-500	Check seat (2)	108.45
TT-26-700	Check seat (2)	108.45
TT-27-1000	Check stop body (2)	755.55
TT-27-900	Check stop body (2)	755.55
TT-32A	Gasket between stops (for 7-900 and 7-1000 Series) (2)	4.65
TT-47N	O-ring	4.50
TT-50AN-200	Complete stop assembly (2)	237.35
TT-50AN-400	Complete stop assembly (2)	302.55
TT-50AN-500	Complete stop assembly (2)	349.50
TT-50AN-700	Complete stop assembly (2)	349.50
VT-103	Thermometer	225.75
VT-105	Escutcheon kit	83.80
VT-112	Handle	96.20
VT-112X	Handle (for seperate diverter)	96.20
VT-9A	Retainer assembly	13.50
W-12	Screws (2)	4.75
W-13	Small gasket (2)	3.95
W-14	Large gasket (2)	3.95
W-2A	Sweat elbow fittings (2)	25.45
WO-20A	Screws (2)	3.95
WS-17	Cover with label for W-500-B	7.40
WS-18/19	Handle and knob	13.25