

EVERLEIGH INDUSTRIAL BAKERS RACK

ASSEMBLY INSTRUCTIONS

FIRSTIME & CO.[®]
— AMERICAN DESIGNED —

STEP 1

Attach end caps (M) to the legs of the side frames (A + B).

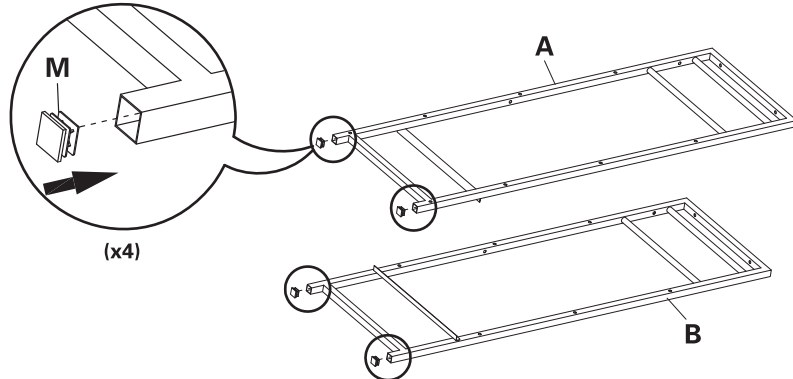

STEP 2

Attach metal rods (F) and shelves (C + D) to the side frames (A + B). Tighten screws 75%.

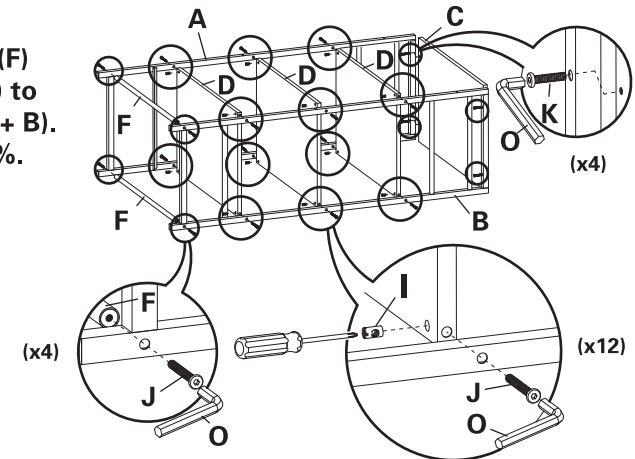

STEP 3

Attach X rods (E) to the back of the bakers rack. Tighten all screws 100%.

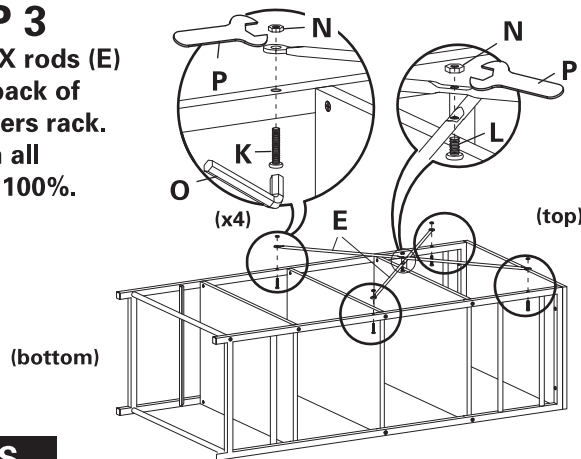

STEP 4

Stand rack upright.

Hang hooks (H) onto the side rods as desired.



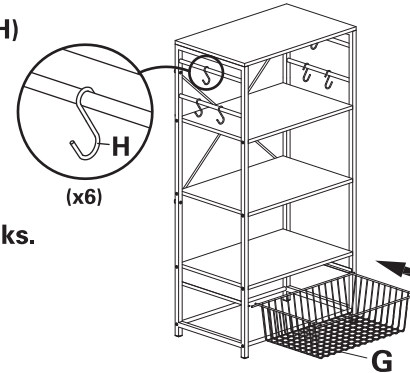



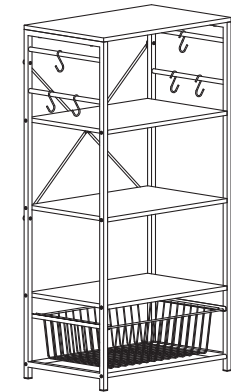





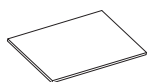
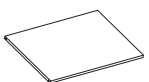



Slide wire basket (G) along the tracks.



FULLY ASSEMBLED



PARTS



A  1 PC	B  1 PC	C  1 PC	D  3 PC	E  2 PC	F  2 PC	G  1 PC	H  6 PC	
I  12 PC	J  2" long 16 PC	K  1 1/8" long 8 PC	L  1/2" long 1 PC	M  4 PC	N  5 PC	O  1 PC	P  1 PC	 PHILIPS HEAD SCREWDRIVER (NOT INCLUDED)

NOTE: PHILIPS HEAD SCREW DRIVER REQUIRED FOR ASSEMBLY (NOT INCLUDED)
DO NOT TIGHTEN SCREWS 100% UNTIL FULLY ASSEMBLED.

EVERLEIGH INDUSTRIAL BAKERS RACK

ANTI-TIP RESTRAINT INSTRUCTIONS

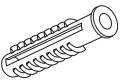
FIRSTIME & CO.[®]
— AMERICAN DESIGNED —

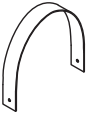
PARTS	
Q	 2 PC
R	 2 PC
S	 2 PC
T	 2 PC
REQUIRED TOOLS (NOT INCLUDED): <ul style="list-style-type: none"> • PHILIPS HEAD SCREWDRIVER • HAMMER 	<p>STEP 1 Wrap restraint strap (T) around back poles as shown.</p> <p>STEP 2 Place bakers rack into position. Install drywall anchors (Q) (if not mounting into a stud), being sure that both are aligned horizontally.</p> <p>STEP 3 Attach both straps (T) to drywall anchors (Q) (or wall stud).</p> <p>⚠ WARNING: Serious or fatal crushing injuries can occur from furniture tip-over.</p> <p>To help prevent tip-over:</p> <ul style="list-style-type: none"> • Affix product to the wall with included anti-tip kit. • Place heaviest items in the lowest drawers or shelves. • Never allow children to climb or hang on drawers or shelves..

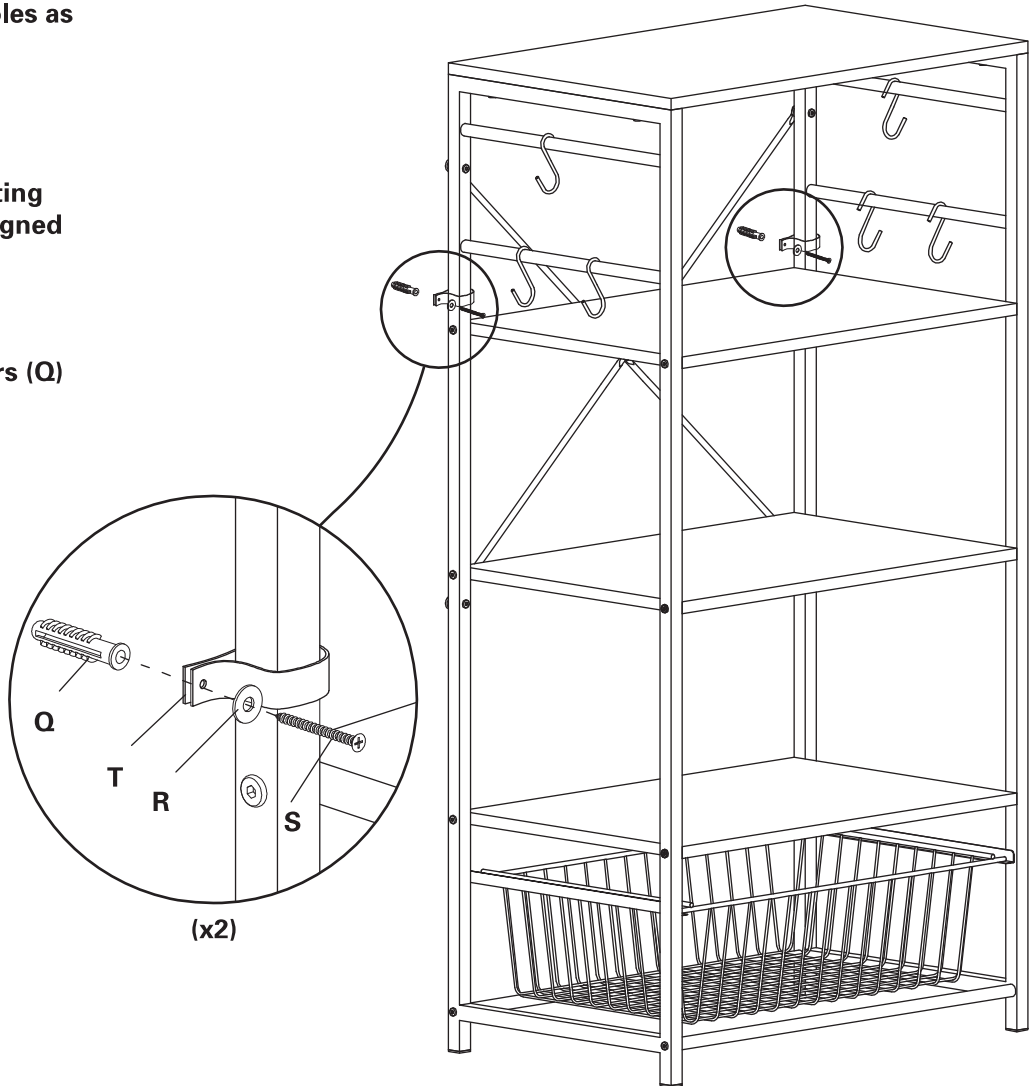

(x2)

⚠ WARNING: USE OF A TIP-KIT WILL ONLY REDUCE, NOT ELIMINATE, TIP-OVER.