

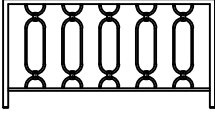

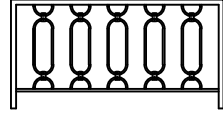





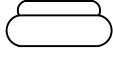

ASSEMBLY INSTRUCTION

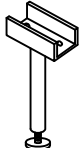
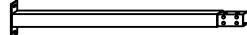
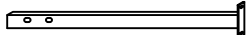
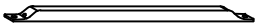
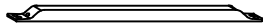
METAL FULL/QUEEN BED

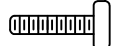
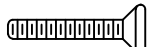
A Headboard  1PC	B Footboard  1PC	C Leg Extensions  2PCS	D Foot Casts  2PCS
E Plugs  2PCS	F Support Legs  4PCS	G Side Rails - Front  2PCS	H Side Rails - Rear  2PCS
I Metal Slats  2PCS	J Center Metal Slat  1PC	K Flat Allen Head Screw 1/4"*1"  4PCS	L Flat Allen Head Screw 1/4"*3/4"  22PCS
M Screw 1/4"*2"  4PCS	N Spring Washers 1/4"  8PCS	O Metal Washers 1/4"  8PCS	P Hex Nut 1/4"  4PCS
Q Allen Key 4mm  1PC	R Wrench 4mm  1PC		

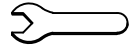
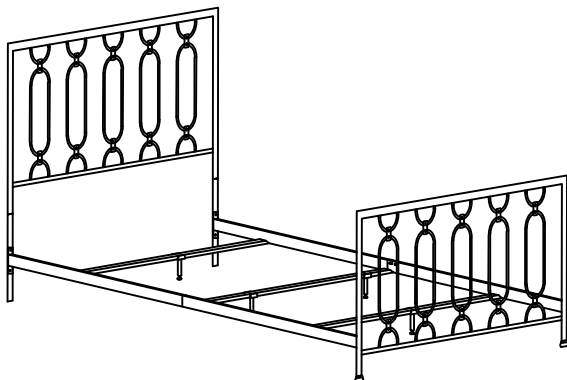

This page lists all the contents included in the box. Please take the time to identify the hardware as well as the individual components to this product. As you unpack and prepare for assembly, place the contents on a carpeted or padded area to protect them from damage.

- 1** Attach Leg Extensions (C) to Headboard (A), use Flat Allen Head Screw (L) and Allen Key (Q), then screw tightly.

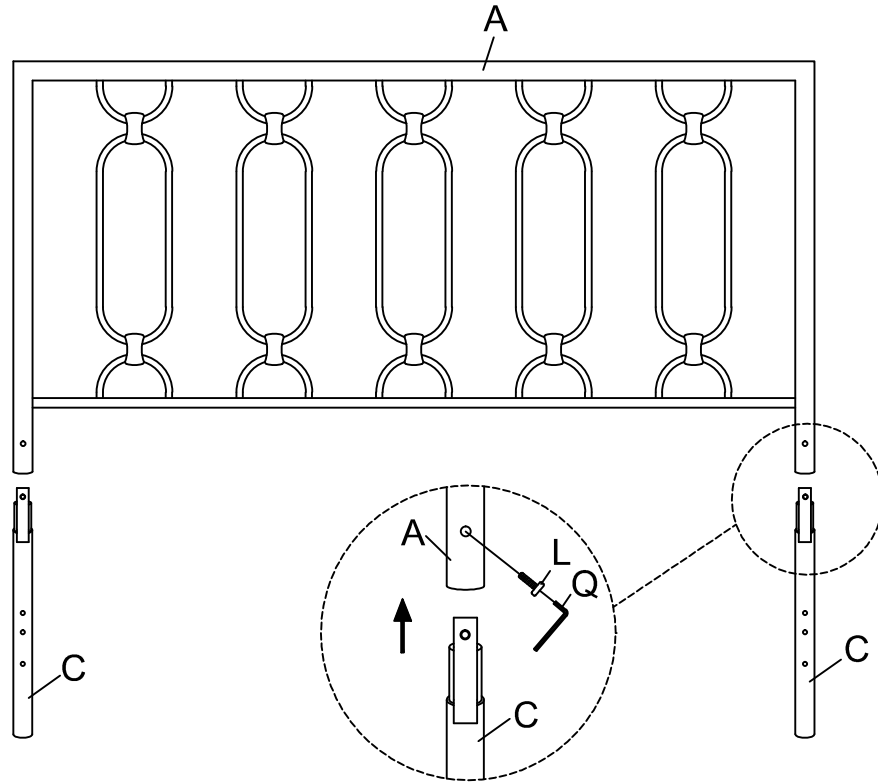

- 2** Put the Foot Casts (D) on the Footboard (B) legs. Then put the Plugs (E) into Foot Casts (D). Screw Side Rails - Front (G) to Side Rails - Rear (H) with Flat Allen Head Screw (L), use Allen Key (Q) to tighten. Then screw Side Rails - Front (G) to Leg Extensions (C), use Screw (M), Metal Washers (O), Spring Washers (N) and Hex Nut (P) with Allen Key (Q) and Wrench (R). Screw Side Rails - Rear (H) to Footboard (B), use Flat Allen Head Screw (K), Spring Washers (N) and Metal Washers (O) with Allen Key (Q).

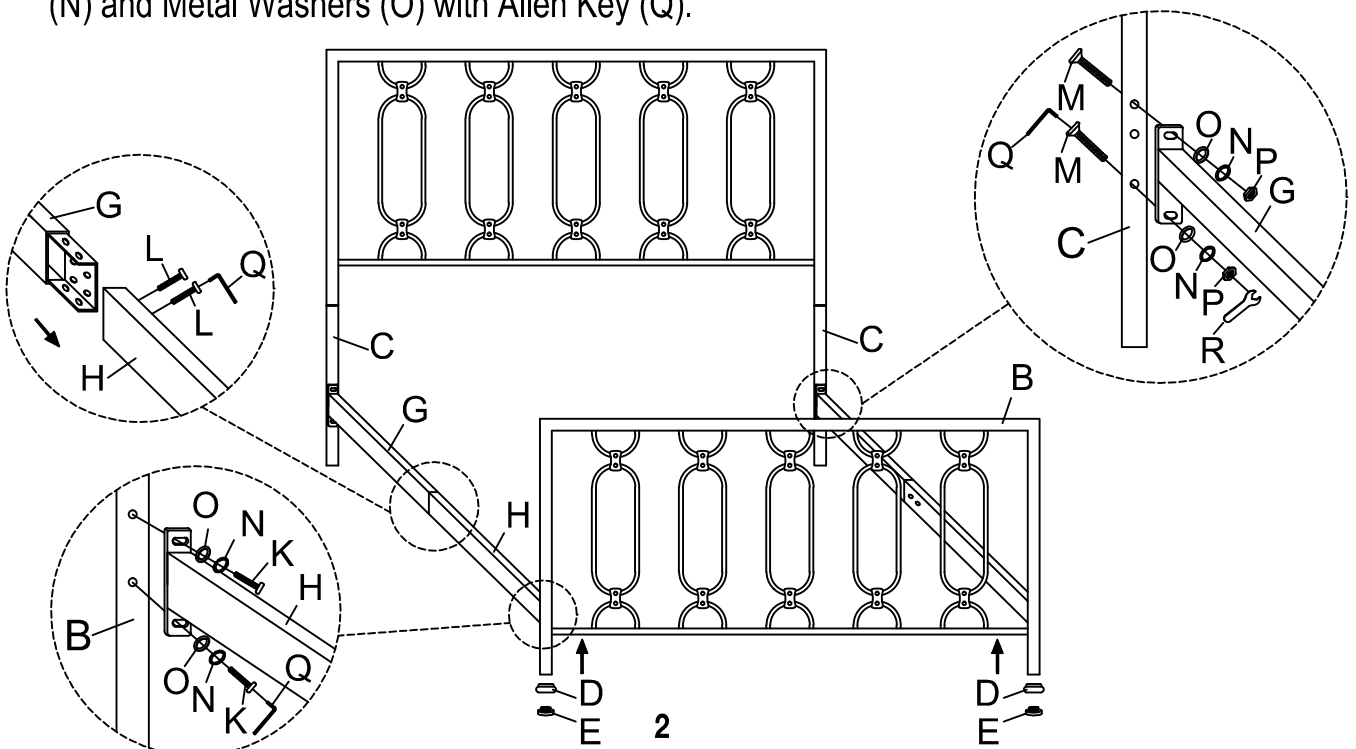

3 Insert Support Legs (F) to Metal Slats (I) and Center Metal Slat (J) with Flat Allen Head Screw (L), use Allen Key (Q) to tighten.

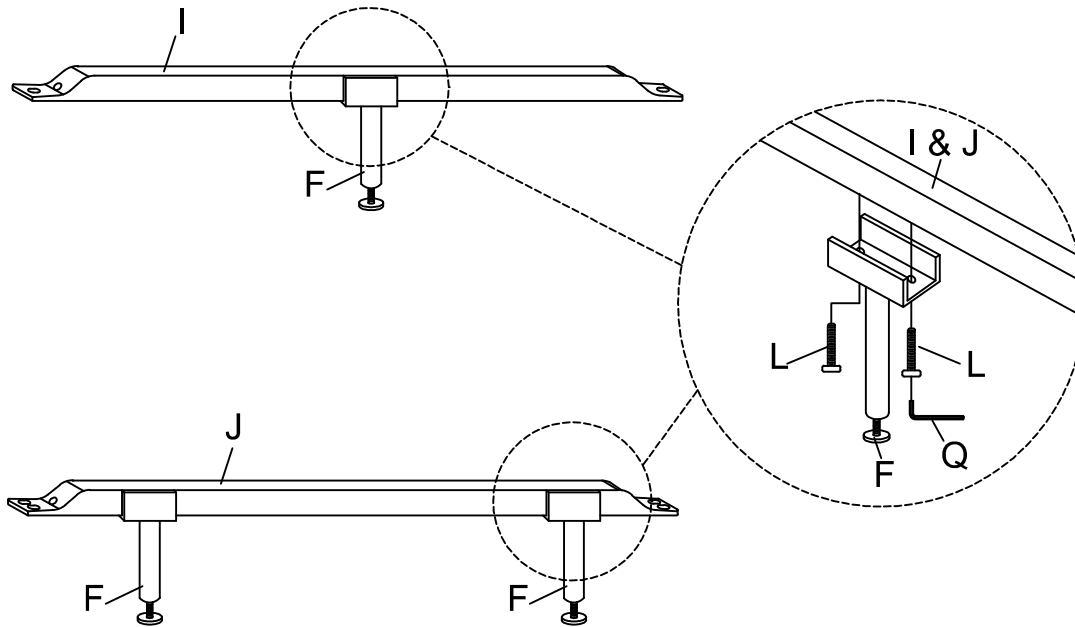

4 Connect Metal Slats (I) and Center Metal Slat (J) to Side Rails - Front (G) and Side Rails - Rear (H), use Flat Allen Head Screw (L) with Allen Key (Q).

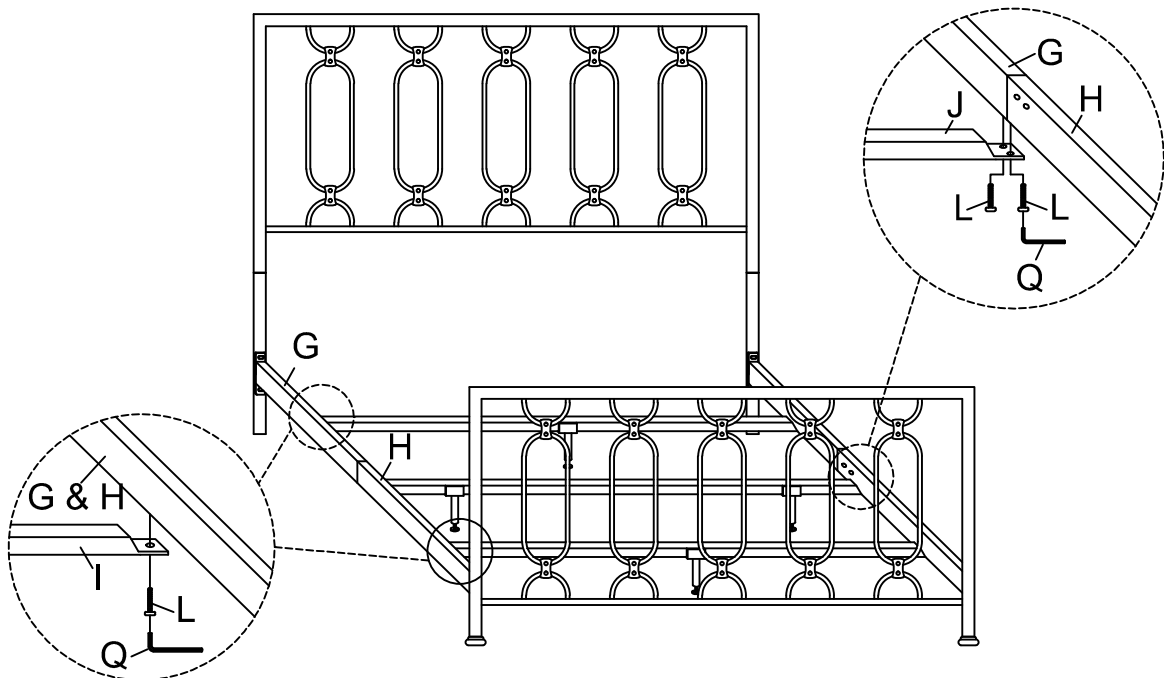

Cleaning & Care

Treat surface with care. Surface is resistant to scratches but is not scratch resistant. Clean surfaces with a dry or damp soft cloth. Do not use abrasive cleaners. Hardware may loosen over time. Periodically check that all connections are tight.