



**Text:** 1-812-652-2525  
(US and Canada only, carrier fees may apply)



**Online:** [www.maxicosi.com](http://www.maxicosi.com)  
**Email:** [support@djgusa.com](mailto:support@djgusa.com)



**Call:** 1-800-544-1108  
(Toll Free, US and Canada only)

## Replacement Parts List

(on select models)

- Seat Pad Set
- Buckle
- Base
- Instructions
- Lower Anchor Belt

For parts availability and questions,  
call, text, email, or chat.

If requested color is not available,  
similar color will be substituted.

Applicable tax and shipping and  
handling will also be added.

©2026 Dorel Juvenile Group, Inc. (800) 544-1108 [www.maxicosi.com](http://www.maxicosi.com). Styles, colors, and labeling may vary. Les styles, les couleurs et l'étiquetage peuvent varier. Made in CHINA. Fabriqué en CHINE. Hecho en CHINA. Distributed by (distribué par) Dorel Juvenile Group, Inc., 2525 State St., Columbus, IN 47201-7494. Dorel Juvenile Canada, 2233 Argentia Road, Suite 110, Mississauga, ON L5N 2X7. Representante exclusivo en Chile: DOREL JUVENILE CHILE S.A. Av. del Parque 4161, oficina 602 A, Huechuraba, Santiago, Chile - Fono: 56 2 24971500 - [www.infanti.cl](http://www.infanti.cl) - [www.dorel.cl](http://www.dorel.cl). Importado y distribuido en Perú por: COMEXA COMERCIALIZADORA EXTRANJERA S.A. SUCURSAL DEL PERÚ - Los Libertadores 455, San Isidro, Lima 27, Lima, Perú RUC 20431062870 - Fono: 4413029 - [www.infanti.com.pe](http://www.infanti.com.pe). En Centro América, Caribe y Ecuador por: Best Brands Group S.A. - Av. Balboa, Bay Mall Plaza, Planta Baja, local 9, Panamá. - Fono: (507) 300 2884. En Colombia por: Baby Universe S.A.S. - Vía 40 No. 77-29, Barranquilla, Colombia - Fono: (575) 353 1110 Importador: DJGM, S.A. DE C.V. Gabriel Mancera No. 1041 Col. Del Valle, Benito Juárez C.P. 03100 México, Ciudad de México R.F.C. DJG140305GN9 Tel. (55) 67199202

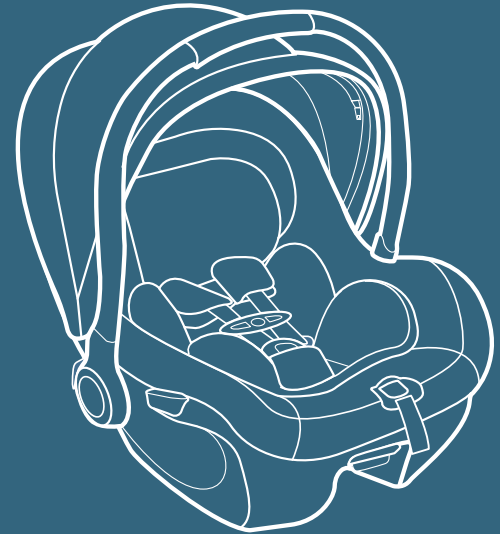

## Peri™ 180 Rotating Infant Car Seat

Your model may look different than one shown on cover.

**Read all instructions BEFORE USING this child restraint.**

**KEEP INSTRUCTIONS FOR FUTURE USE.**

**⚠ Failure to follow the warnings on the labels and in the instruction manual can result in serious injury or death to your child. Serious injury may include paralysis and/or permanent brain injury.**

4358-8797 04.06.26

# Getting Started

To help you get started using your child's new car seat (also known as a child restraint), these are the four main tasks you'll need to complete.

1

**Measure**  
your child.

2

**Adjust** the car  
seat to fit  
your child.

3

**Install** the car  
seat into your  
vehicle.

4

**Secure** your  
child in the  
car seat.

# Contents

Getting Started		
Parts of Car Seat.....	2	
Accessory Use.....	3	
Rear-Facing Requirements.....	4	
Installing Base with Vehicle Belt.....	5	
Installing Base with LATCH:		
Lower Anchor Belt.....	10	
Rotating and Reclining		
Car Seat on Base.....	15	
Load Leg.....	17	
Removing and Installing		
Car Seat to Base.....	19	
Rear-Facing Section.....	21	
Rear-Facing Child Fit.....	22	
Rear-Facing Use with an Installed Base.....	25	
Vehicle Install without Base.....	28	
Securing Child in Car Seat.....	33	
Making Adjustments to Car Seat.....	37	
Changing Headrest/Harness Height.....	37	
Changing Buckle Position.....	38	
Harness System Adjustments		
for Smaller Infants.....	41	
Carrier Use.....	43	
Canopy Use.....	44	
Wash and Care.....	46	
Removing Seat Pads.....	46	
Cleaning Parts of Car Seat and		
Installing Seat Pads.....	48	
LATCH and Vehicle Belt Information.....	49	
LATCH: Lower Anchor Belt.....	49	
Vehicle Belts.....	51	
Safety Information.....	55	
Child Restraint Use.....	55	
Vehicle Seating Position.....	56	
Installation in Vehicle.....	57	
Replacement and Expiration.....	58	
Registration and Safety Notices.....	59	
Aircraft Information.....	60	
Warranty.....	61	

# Parts of Car Seat

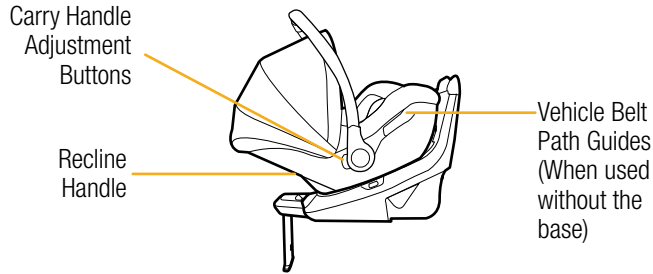
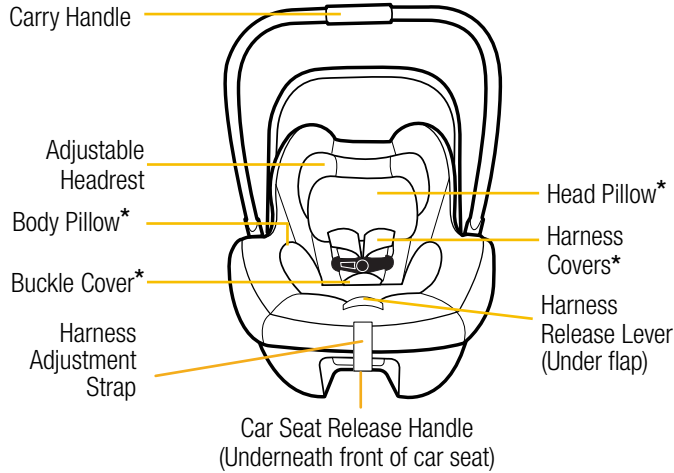

## Harness System

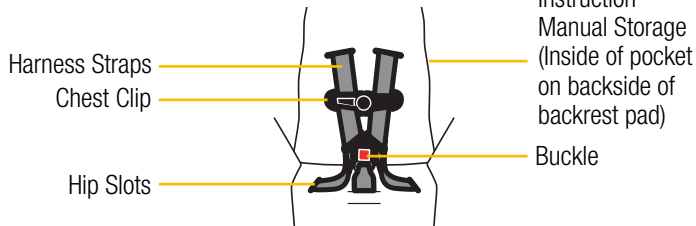

Your model may look different than one shown.

## Front View of Base

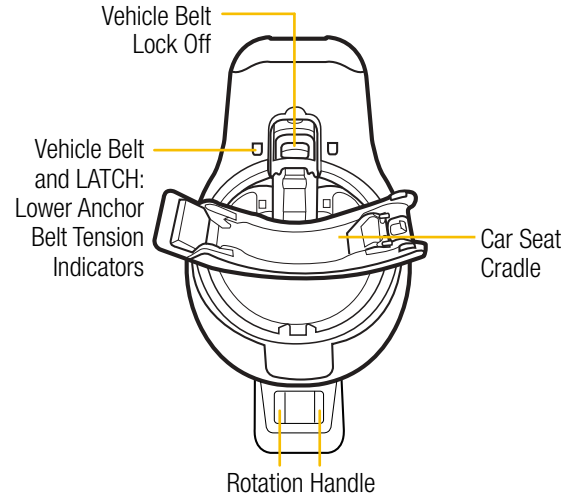

## Side View of Base

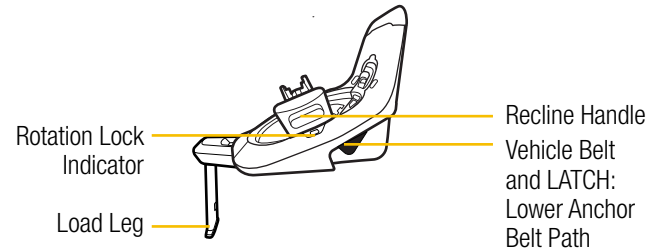

## Bottom View of Base

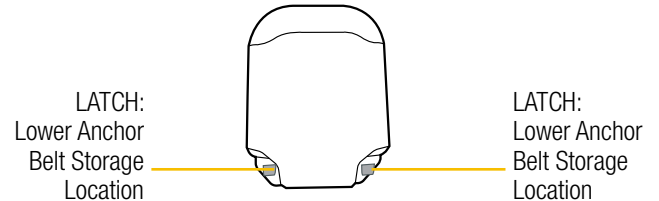

\*See page 3 for Accessory Use.

Accessories are not required for proper use. Use them only if they meet your child's comfort and fit needs.

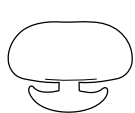

### Head Pillow

(on select models)

**To remove head pillow**, from the back of the head pillow gently pull the fabric tabs out from the harness straps.



### Buckle Cover

(on select models)

**To remove**, undo the buckle and pull the buckle cover off the buckle.

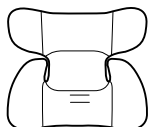

### Body pillow

(on select models)

**To remove**, undo the buckle and pull it through the slot in the pillow. Slide the pillow out from behind the harness straps



### Harness Covers

(on select models)

The harness covers help provide comfort to your child's neck. Always position the harness covers so that the fastener opening is pointed

away from your child's face to prevent irritation or contact with exposed fastener edges.

**To remove**, undo the harness, pull the fastening strips apart and pull the harness covers off of the top part of the harness cover. The bottom part is not removable.

## ⚠ WARNING

Failure to follow these instructions may result in serious injury or death to your child. Serious injury can include paralysis and/or permanent brain injury.

Be certain to measure your child's weight and height (do not guess) before using this car seat.

This car seat can only be used **REAR-FACING**.

Your child's height, weight, and age determine how the car seat should be placed in the vehicle.

Children vary widely in body size, shape, and temperament—**please consult your doctor before switching between any modes within the limits and fit requirements of the car seat.**

### Infants and Toddlers

Children must ride rear-facing and remain rear-facing until they reach the maximum weight or height limits for rear-facing mode. Rear-facing child restraints installed behind another vehicle seat must be installed touching the back of the vehicle seat in front of it, or be as close as possible.

### REAR-FACING

**4–30 lb (1.8–13.6 kg) and  
32 in. (81.3 cm) or less in height**

This car seat can only be used **Rear-Facing**. In this **Rear-Facing** only car seat, your child can use this restraint until they outgrow any one of the above.

- **Rear-Facing Child Fit**, see pages 22–24.



### ⚠️ WARNING

**DO NOT** use both the LATCH: lower anchor belt and vehicle belt at the same time to install the car seat.

**DO NOT** leave child restraint in Side-Facing mode while vehicle is in motion.

Even when unoccupied, this child restraint **MUST** be firmly secured to the vehicle with the lower anchor belt or with the vehicle seat belt in Rear-Facing mode.



Before installing the car seat base:

- **Review Vehicle Owner's Manual.** Determine the type of vehicle belts in your car and how to use them to lock a car seat base in place **OR** where LATCH: lower anchor seating positions are located in your vehicle.
- **For LATCH Belt Installation,** go to page 10.
- Ensure the vehicle is on level ground when installing the base.

1

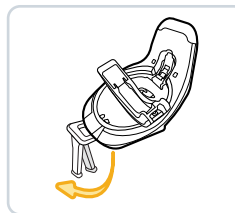

### Unfold Load Leg

When possible, utilize the load leg.

In a crash, load legs reduce downward rotation, limit rebound, and provide additional stability and energy absorption.

### ⚠️ WARNING

**DO NOT** fully extend to the vehicle floor yet. **DO NOT** use the load leg to adjust the base angle.

Review your vehicle owner's manual for load leg use.

2

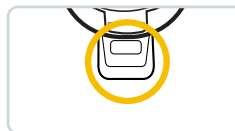

### Place Base in Vehicle Seat

The car seat base **MUST** be flat on the vehicle seat.

Squeeze the rotation handle and swivel the seat to face you in side view.

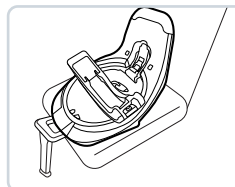

**For Lap Belt only,** skip step 3 and leave lock off closed.  
Go to step 4 on the next page.

3

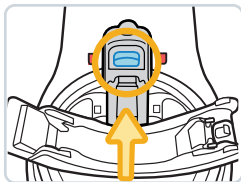

### Open Belt Lock Off

Squeeze the lever to open the belt lock off and pull it forward.

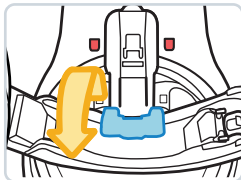

4

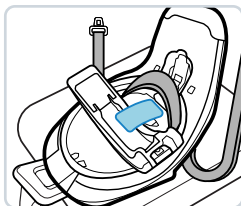

### Weave Vehicle Seat Belt In and Out of Belt Path As Shown

Buckle the vehicle belt.

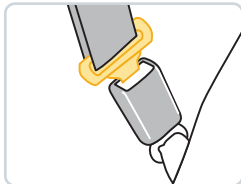

5

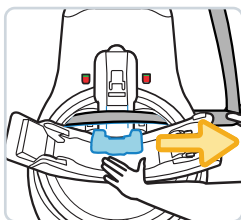

### Tighten Belt and Gently Remove Slack

Place your hand in the base and firmly push the base down and back toward the vehicle seat. Pull the belt parallel (in line) with the belt path as shown.

6

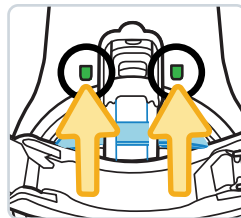

### Close Belt Lock Off

Both indicators will turn completely green when vehicle belt is properly installed. If not completely green, repeat steps 3-5 and make sure to remove any additional slack in step 5.

i

If your car has a vehicle belt that can switch to locking mode, you **MUST** use it to lock the belt.

**Switching vehicle belt to locking mode:** Slowly pull the shoulder belt all the way out, then let it retract 1–2 in. (2.5–5 cm).

As it retracts, you will most likely hear a ratcheting sound.

Gently pull the belt to see if it is locked. You will not be able to pull any more belt out once the lock has engaged.

7

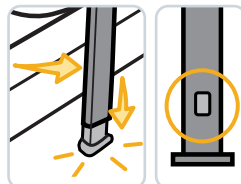

### Extend Load Leg

Squeeze the button (located at back of the leg) on the load leg and pull it down until it meets the vehicle floor.

Release the button.

Lift the front of the base while holding the load leg in place as shown to lock it into position.

The load leg **MUST BE** perpendicular to the vehicle floor.

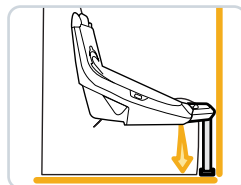
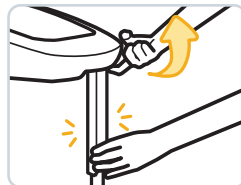

### ⚠️ WARNING

**DO NOT** use the load leg if it does not reach the floor of your vehicle.

**DO NOT** use the load leg on top of vehicle storage compartments. Review your vehicle owner's manual.



If the base moves more than 1 in. (2.5 cm) side to side at the belt path, you can try:

- Pulling the belt tighter; **OR**
- Reinstalling the base; **OR**
- Changing to a different seating location; **OR**
- Switching to a different install method (LATCH: Lower Anchor Belt).

### FINISHED!

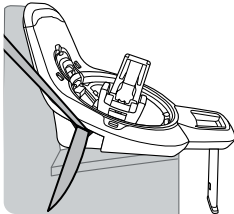

#### Belt Tension Indicators Completely Green?

If they are not green, see steps 3–6.

**Car Seat Cradle Side-Facing As Shown?** If it is not side-facing, squeeze the rotation handle and move it into side-facing position.

**Rear-Facing Child Fit:** pages 22–24.

When using the passenger and driver side locations, the car seat **MUST** be touching the back of the vehicle seat in front of it, or be as close as possible.

### ⚠️ WARNING

**DO NOT** use both the LATCH: lower anchor belt and vehicle belt at the same time to install the car seat.

**DO NOT** leave child restraint in Side-Facing mode while vehicle is in motion.

Even when unoccupied, this child restraint **MUST** be firmly secured to the vehicle with the lower anchor belt or with the vehicle seat belt in Rear-Facing mode.



Before installing the car seat base:

- **Review Vehicle Owner's Manual.** Determine the type of vehicle belts in your car and how to use them to lock a car seat base in place **OR** where LATCH: lower anchor seating positions are located in your vehicle.
- If you are using a vehicle belt to install the base, make sure the lower anchor belt is stored away (see page 49).
- Ensure the vehicle is on level ground when installing the base.

1

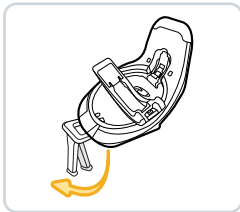

### Unfold Load Leg

When possible, utilize the load leg. In a crash, load legs reduce downward rotation, limit rebound, and provide additional stability and energy absorption.

## ⚠ WARNING

**DO NOT** fully extend to the vehicle floor yet. **DO NOT** use the load leg to adjust the base angle.

Review your vehicle owner's manual for load leg use.

2



### Place Base in Vehicle Seat

The car seat base **MUST** be flat on the vehicle seat.

Squeeze the rotation handle and swivel the seat to face you in side view.

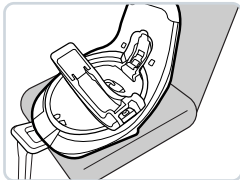

3

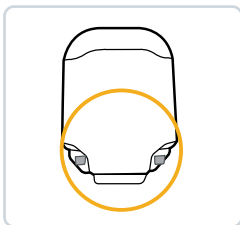

### Take Lower Anchor Belt Out of Storage Location

i

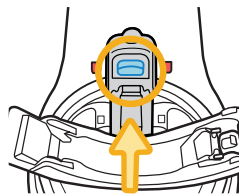

### Vehicle Belt Lock Off **MUST BE** Closed **BEFORE** Routing Lower Anchor Belt

4

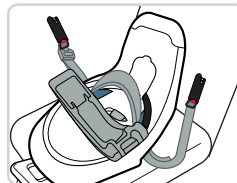

### Weave Lower Anchor Belt In and Out of Belt Path

You may need to fully lengthen the belt before routing it into the belt path. Squeeze the adjuster button and pull the belt out as shown.

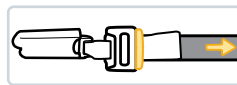

Weave the connector without the adjuster closest to it through the belt path.

5



### Attach LATCH Connectors to Vehicle's LATCH Anchors

Review your vehicle owner's manual for LATCH anchor locations and LATCH belt use.

Make sure arrows on connectors are facing up.

Fasten one LATCH belt connector to the anchor located in the vehicle seat.

**Repeat for the other side of the base.**

6

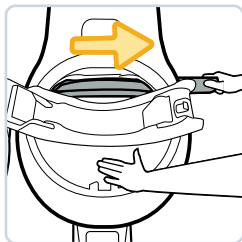

### Tighten Belt and Gently Remove Slack

Place your hand in the base and firmly push the base down and back toward the vehicle seat.

Pull the belt parallel (in line) with the belt path as shown.

Tension indicators will begin to turn **green**.

Both indicators will turn **completely green** when the LATCH is properly installed.

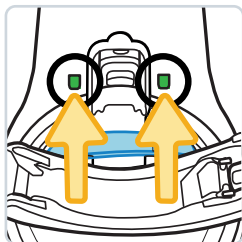

i

If the base moves more than 1 in. (2.5 cm) side to side at the belt path, you can try:

- Pulling the belt tighter; **OR**
- Reinstalling the base; **OR**
- Changing to a different seating location; **OR**
- Switching to a different install method (vehicle belt).

7

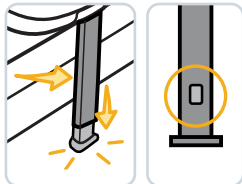

### Extend Load Leg

Squeeze the button (located on back of leg) on the load leg and pull it down until it meets the vehicle floor.

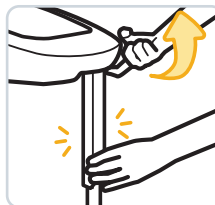

Release the button.

Lift the front of the base while holding the load leg in place as shown to lock it into position.

The load leg **MUST BE** perpendicular to the vehicle floor.

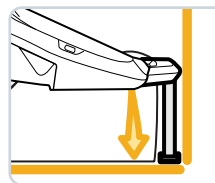

## ⚠ WARNING

**DO NOT** use the load leg if it does not reach the floor of your vehicle.

**DO NOT** use the load leg on top of vehicle storage compartments. Review your vehicle owner's manual.

## FINISHED!

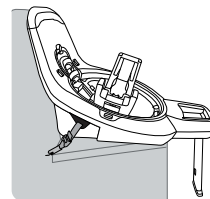

### Belt Tension Indicators Completely Green?

If they are not green, see steps 4–6.

**Car Seat Cradle Side-Facing As Shown?** If it is not side-facing, squeeze the rotation handle and it move into side-facing position.

**Rear-Facing Child Fit:** pages 22–24.

When using the passenger and driver side locations, the car seat **MUST** be touching the back of the vehicle seat in front of it, or be as close as possible.

# Rotating and Reclining Car Seat on Base

## Rotating Car Seat

You must squeeze the **Rotation Handle** on the front of the base to move the seat out of Rear-Facing position.



**Rotation Handle**

The **Rotation Lock Indicator** will show the **locked** symbol when the car seat is locked in place.

### **WARNING**

**SIDE-FACING Position ONLY** for use when:

- Placing car seat shell onto the base.
- Placing child into car seat.
- Removing child from car seat.

## Side-Facing Position (Towards Parent)

To rotate the car seat from Side-Facing position, firmly rotate the seat towards the back of the base.

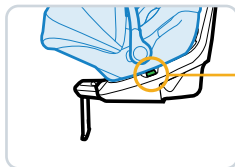
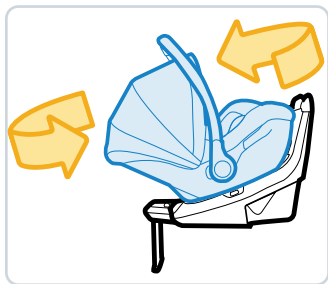

The **Rotation Lock Indicator** will show the **locked** symbol when the car seat is locked in place.

## Reclining Car Seat

There are 5 recline positions.

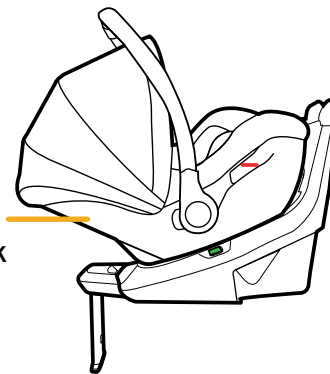

**Recline Handle**  
(located on back  
of Car Seat)

**To Recline:** Squeeze the recline handle and push the top of the car seat back.

**For a More Upright Position:** Squeeze the recline handle and pull the top of the car seat forward.

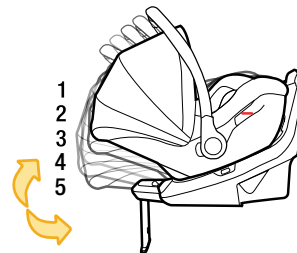

For children **who cannot sit up unassisted**, the **Rear-Facing Level Line** on the car seat **MUST** be parallel with the ground using **any position**.

For children **who can sit up unassisted**, you may make the car seat more upright in **any position**.



The load leg is stored under the base. When possible, utilize the load leg.

The base install is equally safe with or without the use of the load leg.

In a crash, load legs reduce downward rotation, limit rebound, and provide additional stability and energy absorption.

1

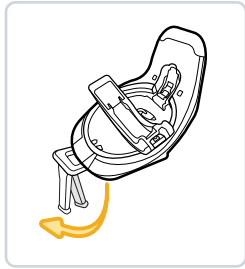

**Fold the load leg out**

2

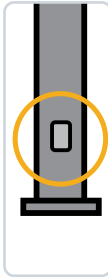
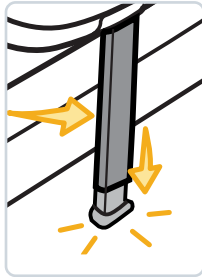

**Squeeze button on load leg**

The button is located on the back of the load leg.

Pull it down until it meets the vehicle floor.

Release the button.

Lift the front of the base while holding the load leg in place to lock it into position.

3

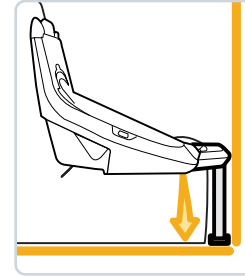

**Check to see if perpendicular**

The load leg **MUST BE** perpendicular to the vehicle floor.

## **⚠ WARNING**

**DO NOT** use the load leg on top of vehicle storage compartments. Review your vehicle owner's manual.

**DO NOT** use the load leg if it does not reach the floor of your vehicle. When not in use, the load leg **MUST** be stored under the base.

# Removing and Installing Car Seat to Base

The Car Seat Cradle **MUST BE Side-Facing** to attach or remove the car seat from the base.

To rotate and recline car seat, see pages page 15–16.

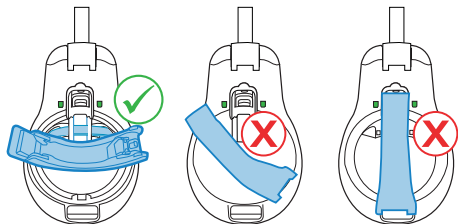

If you are having trouble installing the car seat to the base, check the position of the switch on the cradle. Make sure the switch is pushed to the right as shown.

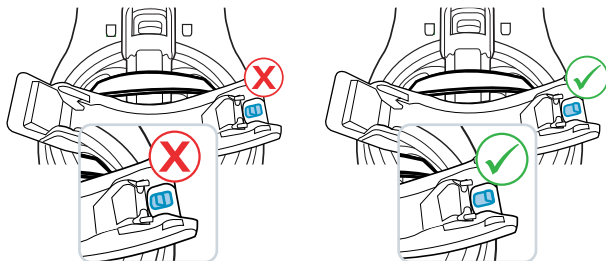

## ⚠️ WARNING

When installing with a base, only use this car seat with a compatible Maxi-Cosi Infant Car Seat Base.

Failure to use a correct base can cause serious injury or death. Failure to securely attach a child restraint to base can result in serious injury or death. Serious death or injury can include paralysis and/or permanent brain injury.

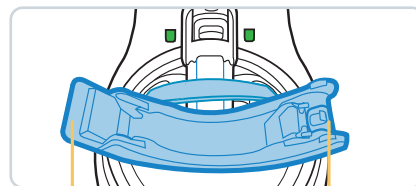

Back of Car Seat Goes Here

Front of Car Seat Goes Here

## Installing Car Seat to Base

1

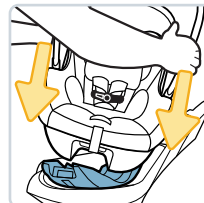

Align Bar on Back of Car Seat into Cradle

2

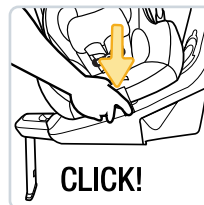

Push Down on Front of Car Seat to Lock into Cradle

## FINISHED!



The car seat has been installed into the Side-Facing position.

## To Remove Car Seat from Base

1. Squeeze the car seat release handle.
2. Pull car seat up from the base.



**4-30 lb (1.8-13.6 kg) and  
32 in. (81.3 cm) or less in height**

In this **Rear-Facing** only car seat, your child can use this restraint until they outgrow any one of the following:

- **Weight Limit:** 30 lb (13.6 kg); **OR**
- **Height Limit:** 32 in. (81.3 cm); **OR**
- **Rear-Facing Child Fit** requirements, see page 22.

Please see page 3 for accessory use.

## ⚠ WARNING



**NEVER** install a rear-facing child restraint in the front seat of a vehicle equipped with an active frontal airbag. **DO NOT** use the lower anchor belt along with the vehicle lap or lap/shoulder belt.

**DO NOT** fasten multiple lower anchor connectors on the same lower anchor bar in the vehicle.

Check the vehicle belt or the lower anchor belt before each use. Use **ONLY** if the belt can be tightened properly and locked securely in place. **DO NOT** leave child restraint in side-facing position while vehicle is in motion. Even when unoccupied, this child restraint **MUST** be firmly secured to the vehicle with the lower anchor belt or with the vehicle seat belt. This child restraint **MUST ALWAYS** face the rear of the vehicle.

1

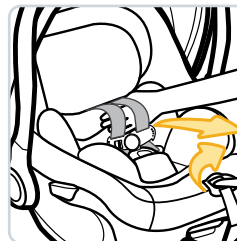

### Fully Loosen Harness Straps

Push down on the harness release lever (through the opening in the pad) while pulling at or below the harness covers as shown.

2

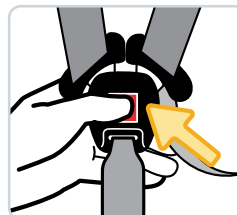

### Undo Buckle

3

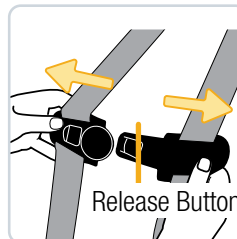

### Undo Chest Clip

Hold each side of the chest clip. Press the release button with your thumb. Pull the chest clip and release button apart.

4

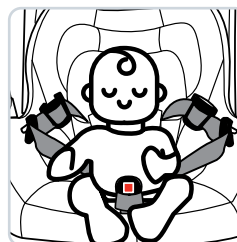

### Place Child in Car Seat

Your child's bottom and back should be flat against the car seat. Position the harness straps over your child's shoulders and upper thighs.

5

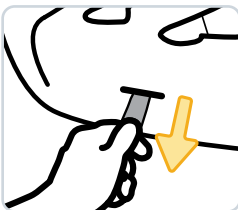
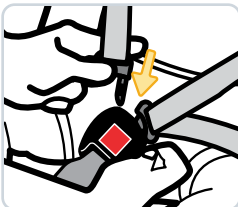
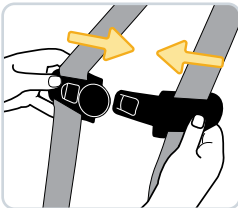

## Fasten Chest Clip and Buckle Harness

Pull the harness adjustment strap straight out to snugly tighten the harness. Position the chest clip mid-chest (even with the armpits) and away from your child's neck.

See Securing Child in Car Seat on page 33 for details on chest clip position and checking harness tightness.

6

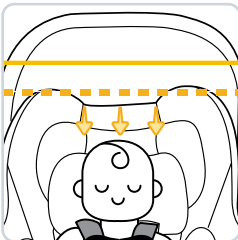

## Check Headrest Position

The top of your child's head **MUST be at least 1 in. (2.5 cm) below** the top of the car seat's headrest.

7



## Check Harness Strap Position

The harness strap **MUST** be placed **at the shoulder** when possible, or slightly below; never above.

8

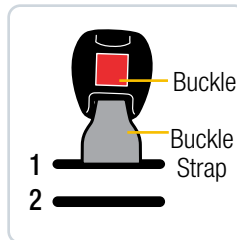

## Check Buckle Position

- Use the slot closest to your child.
- The buckle strap **should not be underneath or behind** your child.

i

### Need to make adjustments?

To change headrest or harness height, see page 37.

To change buckle position, see pages 38–40.

If you cannot achieve a snug harness fit for your child, see Harness System Adjustments for Smaller Infants on pages 41–42.

For Rear-Facing Use with an Installed Base, see page 25.

To install the car seat without the base, see page 28.

## Rear-Facing Use with an Installed Base

1

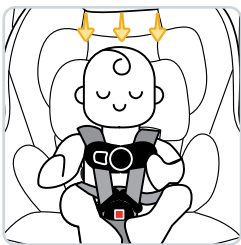

### Secure Child in Car Seat

To properly secure your child in the car seat, see pages 33–35.

Check your child's fit often and make any needed adjustments to the car seat as they grow.

2

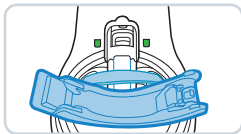

### Rotate Car Seat in Side-Facing Position on Base

Squeeze the rotation handle and swivel the seat to face you in side view.

3

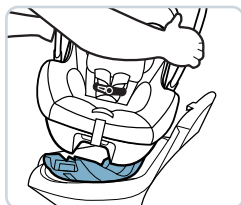

### Attach Car Seat to Base

Align bar on back of car seat into cradle.

Push down on front of car seat to lock into cradle.

The car seat base **MUST** be flat on the vehicle seat.

i

Another way to do this is tip the car seat towards you, with the bar on the back of the seat slightly further than the back of the cradle. Pull it towards you, using the cradle as a guide, until it clicks into place.

Push down on front of car seat and pull up on the carry handle to ensure it is locked into the cradle.

4

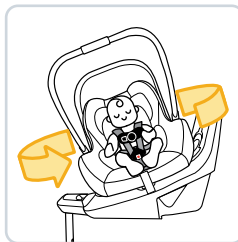

### Rotate Car Seat Towards Rear-Facing Position

The Rotation Lock Indicator will show the **locked** symbol when the car seat is locked in place.

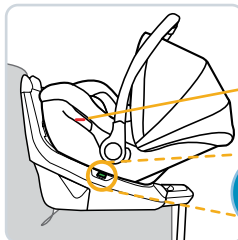

Check **Rear-Facing Level Line**.

i

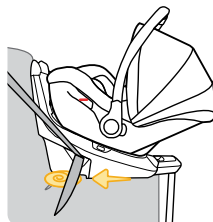

Only if necessary, you may place a tightly rolled towel(s) or foam pool noodle(s) under the front of the car seat base to help make the **Rear-Facing Level Line** parallel with the ground.

Check often to make sure padding is still in place and the belt is tight.

i

**To secure child in car seat and learn how to check harness tightness, see pages 33–35.**

**To change the harness strap height, see page 37.**

**To change the buckle position, see pages 38–40.**

# FINISHED!

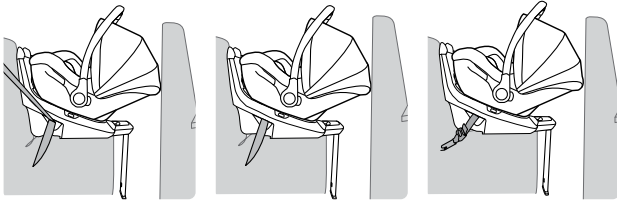

Lap/Shoulder Belt



Lap Belt



LATCH: Lower Anchor Belt

When using the passenger and driver side locations, the car seat **MUST** be touching the back of the vehicle seat in front of it, or be as close as possible.

- ☑ Is the based locked? See step 4
- ☑ Is the level line on the car seat parallel with the ground? See step 4.
- ☑ **Base Vehicle Belt Install:** See page 5.
- ☑ **Base LATCH: Lower Anchor Belt Install:** See page 10.

## Vehicle Install without Base



Lap/Shoulder Belt



Lap Belt



Before installing the car seat:

- **Review Vehicle Owner's Manual.** Determine the type of vehicle belts in your car and how to use them to lock a car seat in place.
- Ensure the vehicle is on level ground when installing the car seat.

1

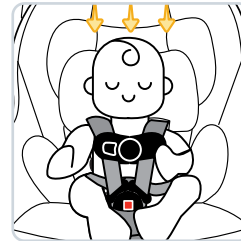

### Secure Child in Car Seat

To properly secure your child in the car seat, see pages 33–35.

Check your child's fit often and make any needed adjustments to the car seat as they grow.

2



### Place Car Seat in Vehicle Rear-Facing

Center the car seat in the chosen seating position.

The carry handle **MUST** be upright and locked when carrying and when installed in the vehicle.

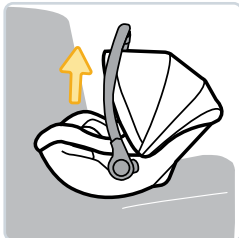

3

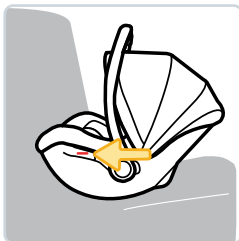

### Check Level Line

Check the level line on the side of shell to see if it is parallel with the ground.

Adjust if needed.

4

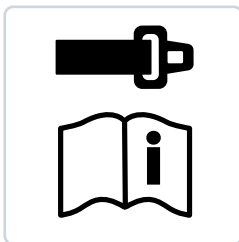

### Check if Your Vehicle Belts Will Work With This Car Seat

This is very important because **not all vehicle belts will work with car seats.**

Review pages 51–54 and your vehicle owner's manual to find out what kind of vehicle belts are in your car and how to lock a car seat in place.

5

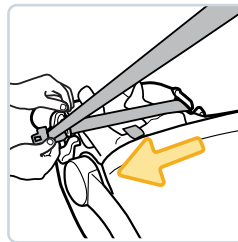

**Route Vehicle Lap or Lap Portion of the Lap/Shoulder Belt Through Shell Belt Path on Both Sides of Shell As Shown**

6

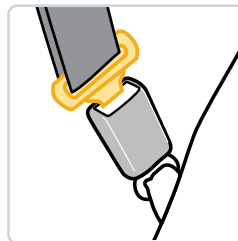

### Buckle Vehicle Belt

If your car's vehicle belt has a switchable retractor, use it to lock the vehicle belt.

For information about switchable retractors, see page 53 or review your vehicle owner's manual.

7

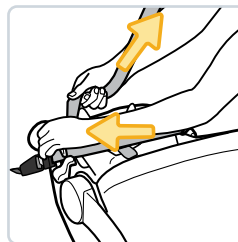

### Tighten Belt

Lay your forearm across the car seat at the belt path while pulling the shoulder belt or the free end of the lap belt to tighten.

8

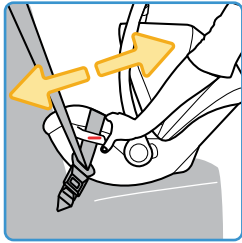

### Check Belt Tightness

Hold the car seat at the belt path with your non-dominant hand. Push and pull from side to side. It should not move more than **1 in. (2.5 cm)** at the belt path.

i

If it moves more than 1 in. (2.5 cm), you can try:

- Pulling the belt tighter; **OR**
- Reinstalling the car seat; **OR**
- Changing to a different seating location

9

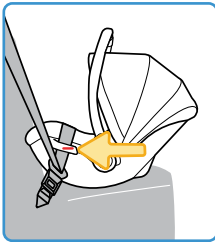

### Recheck Level Line

Redo the installation if the level line is not parallel with the ground.

i

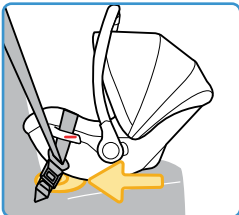

Only if necessary, you may place a tightly rolled towel(s) or foam pool noodle(s) under the front of the car seat base to help make the **Rear-Facing Level Line** parallel with the ground.

Check often to make sure padding is still in place and the belt is tight.

FINISHED!

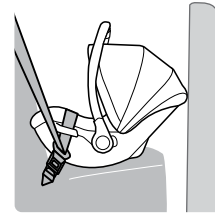

Lap/Shoulder  
Belt

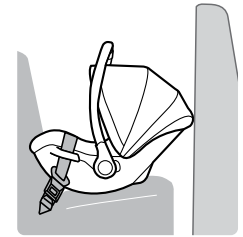

Lap Belt

When using the passenger and driver side locations, the car seat **MUST** be touching the back of the vehicle seat in front of it, or be as close as possible.

- ✓ **Carry Handle Position:** Is your carry handle in the correct position? See step 2.
- ✓ **Level Line:** Is your child's car seat level line parallel? See step 3.
- ✓ **Rear-Facing Child Fit:** See page 22.
- ✓ **Base Vehicle Belt Install:** See page 5.

1

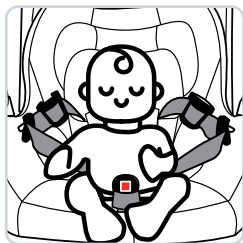

## Place Child in Car Seat

Your child's bottom and back should be flat against the car seat.

Position the harness straps over your child's shoulders and upper thighs.

2

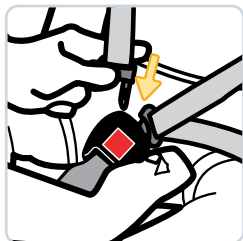

## Buckle Harness

Push the buckle tongues into the buckle until you hear them "click".

Pull up on the harness straps to make sure the buckle is locked.

3

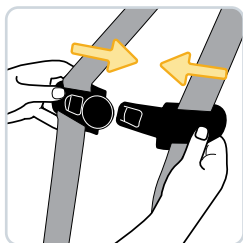

## Fasten Chest Clip

Insert the right half of chest clip into the left half.

Gently push each half of the chest clip together.

Pull gently on each half of the chest clip together to make sure it is locked.

4

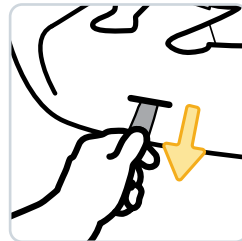

## Tighten Harness

Pull the harness adjustment strap straight out to snugly tighten the harness.

5

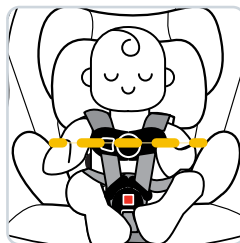

## Position Chest Clip

Pull the harness covers down on the child.

Place the chest clip on the lower part of the harness cover so that the harness covers are between your child and the chest clip.

Position it at mid-chest (even with armpits) and away from your child's neck.

6

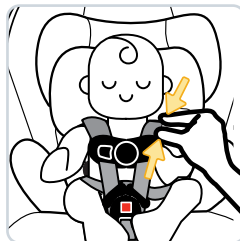

## Check Harness Tightness

Unfasten the harness covers.

Try to pinch the harness at the shoulders vertically between index finger and thumb as shown.

**If your fingers slip off**, the harness is tight enough.

**If you can pinch the harness strap**, tighten more.

Fasten the harness covers.



A snug strap should not allow any slack. It lies in a relatively straight line without sagging. It does not press on the child's flesh or push the child's body into an unnatural position.

If one side of the harness is tighter than the other, lengthen the tighter side by pulling up the harness near the hip slot.

7

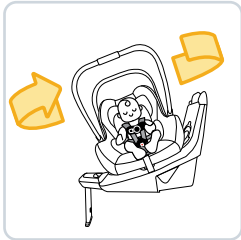

### Rotate Car Seat towards Rear-Facing Position

If you are using the car seat with the base, the rotation lock indicator will show the **locked** symbol when the car seat is locked in place.

## FINISHED!



Your child is now secured in the car seat. Check your child's fit often and make any needed adjustments to the car seat as they grow.

### To Remove Child from Car Seat:

1. Loosen harness strap.
2. Unbuckle harness.
3. Release chest clip.
4. Remove child.

### Troubleshooting

**1. If the buckle or harness release lever sticks: DO NOT lubricate.** Check for dropped food, sticky spilled drinks, dirt, leaves, etc.

Clean with warm water and/or remove the object with tweezers. If you cannot get the harness to adjust and remain tight with the buckle securely locked, **DO NOT** use this car seat.

**2. If the harness twists:** Straighten the harness each time you put your child in the car seat. Lock the buckle and tighten the harness so it will be ready for next use.

## ⚠️ WARNING

Failure to fasten and tighten the harness system correctly may allow the child to be ejected from the child restraint in a crash or sudden stop causing serious injury or death. Serious injury can include paralysis and/or permanent brain injury.

**DO NOT** mistake comfort for safety. The harness system **MUST** be snugly adjusted.



**DO NOT** put snowsuits or bulky garments on your child when placing them in the child restraint.

Bulky clothing can prevent the harness straps from being tightened properly.

1

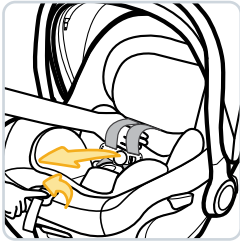

### Fully Loosen Harness Straps

Push down on the harness release lever (through the opening in the pad) while pulling at or below the harness covers as shown.

2

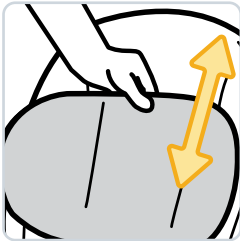

### Adjust Headrest/ Harness Height

1. Squeeze the adjustment handle lever up.
2. Move the headrest up or down to the proper height for your child.

3. Release the handle to lock in place.
4. Make sure it is locked securely.



**For Rear-Facing Child Fit**, see page 22–24.

To learn how to check harness tightness, see pages 33–35.

Check the harness straps often for any wear or damage.

## ⚠️ WARNING

Failure to place buckle's metal retainer completely through pad and child restraint can result in serious injury or death. Serious injury can include paralysis and/or permanent brain injury.

1

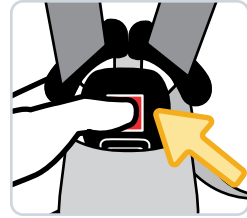

### Undo Buckle

2

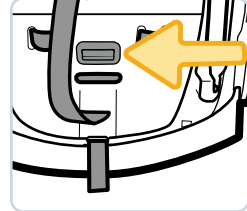

### Turn Car Seat Over

Locate the buckle's metal retainer on the bottom of the shell.

3

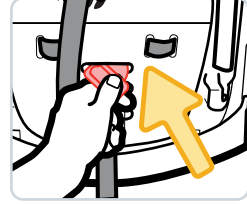

### Rotate Metal Retainer and Push It Up Through Shell and Pad

4

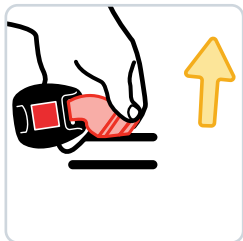

From Top of Car Seat,  
Pull Buckle Out of  
Shell and Pad

5

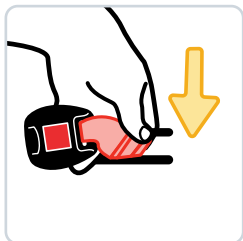

Insert Buckle's  
Metal Retainer into  
Buckle Slot Closest  
to Your Child

The buckle **MUST** face out.

6

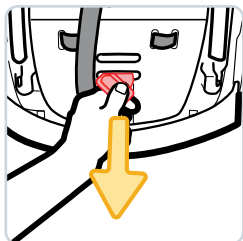

From Bottom of Car  
Seat, Pull Buckle's  
Metal Retainer  
Completely Through  
Pad and Shell

7

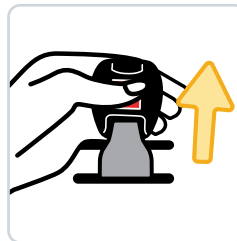

**Check Buckle**

Pull up on the buckle to  
make sure it is secured.

The buckle **MUST NOT**  
pull out.

i

**For Rear-Facing Child Fit**, see page 22–24.

**Check your child's fit often. If you cannot achieve a snug harness fit for your child**, see pages 41–42.

**To learn how to check harness tightness**, see pages 33–35.

# Harness System Adjustments for Smaller Infants



If you cannot achieve a snug harness fit for your child, make these adjustments.

These adjustments should only be in place until your child is big enough to fit in the car seat without them. The buckle strap and harness system should not press on the child's flesh or push the child's body into an unnatural position. See page 34 for how to check harness tightness.

1

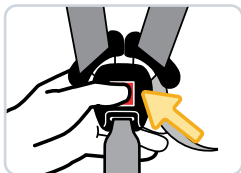

## Undo Buckle and Undo Chest Clip

Press the red button to unbuckle the harness.

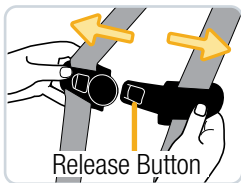

Hold each side of the chest clip.  
Press the release button with your thumb.  
Pull the chest clip and release button apart.

2

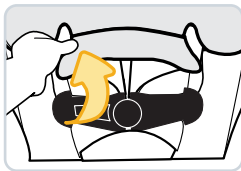

## Undo Fasteners on Seat Pad

Pull the car seat pad towards you.

3

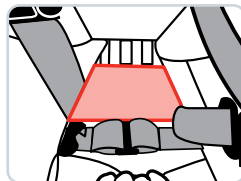

## Locate Foam under the Seat Pad

Undo the fastening strips as shown.

4

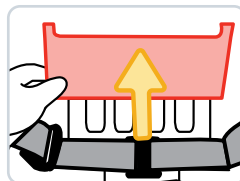

Remove Foam from Car Seat Shell

5

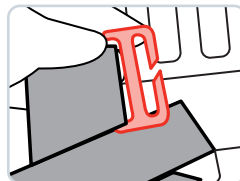

Unloop Harness Strap from Clip

6

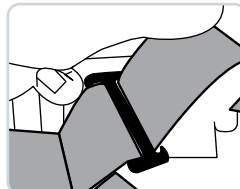

Attach 2nd Harness Strap Loops

7

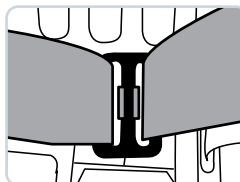

Place Clip in Center Bar on Shell

Push firmly until you hear the clip "click" into place.

8

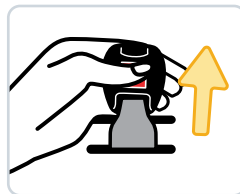

Replace Foam and Seat Pad and Check Buckle

Pull up on the buckle to make sure it is secured.

The buckle **MUST NOT** pull out.



For Rear-Facing Child Fit, see page 22–24.

To learn how to check harness tightness, see pages 33–35.



**To Adjust Carry Handle**

Squeeze both adjustment buttons on each side of the carry handle.

Rotate the carry handle up or down to the desired location. Release the buttons.

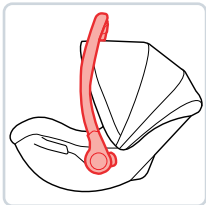

Make sure both carry handle adjustment buttons are in the locked position.

**The carry handle must be upright AND locked when carrying and when installed in the vehicle.**

**⚠ WARNING**

Read ALL instructions before using child restraint as a carrier.

**NEVER** use carrier unless child is properly secured.

Use only as a carrier by children weighing 4–30 pounds (1.8–13.6 kg) and 32 inches (81.3 cm) or less in height.

**NEVER** leave child unattended. Always keep child within arm's reach.

**Suffocation Hazard:** Infant carrier can roll over on soft surfaces and suffocate child. **NEVER** place carrier on beds, sofas, or other soft surfaces.

**Strangulation Hazard:** Children have **STRANGL**ED in loose or partially buckled harness straps. Fully restrain the child even when carrier is used outside the vehicle.



**Fall Hazard:** Child's activity can move carrier. **NEVER** place carrier on counter tops, tables, or any other elevated surface.

The carrier can fall from the shopping cart. **DO NOT** use on shopping cart.

**DO NOT** use the carrier if it is damaged or broken, or if any parts are missing.

**⚠ WARNING**



**DO NOT** use this canopy with children who have an implanted electronic medical device.

A magnet is used to help secure the canopy locking mechanism together which may interfere with the proper function of an implanted electronic medical device.

Parents or caregivers who have an implanted electronic device should keep their device away from the canopy and consult their doctor and medical device manufacturer for specific information before using this canopy.



For wash and care instructions, see page 48.

**Removing Canopy**

1

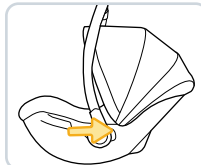

**Locate Canopy Post**

There is one on either side of the car seat. You only need to undo one to remove the canopy.

2

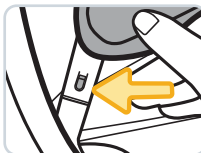

**Pull Back Canopy Fabric to Locate Tab on Canopy Post**

3

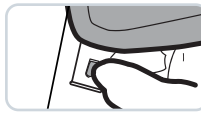

**Press Tab In With Your Thumb and Pull Canopy Hoop Off Canopy Post**



## Installing Canopy

1

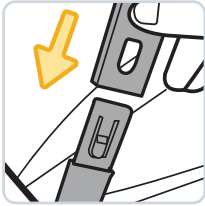

Attach Canopy Hoop to Canopy Post

2

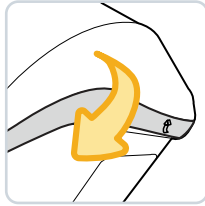

Pull Canopy Over Back of Shell Over Edge

## To Extend Canopy

1

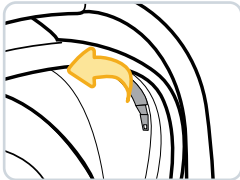

Unzip pocket on front of canopy

2



Pull extended canopy out of pocket

3

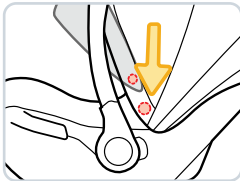

Attach magnets to inside of canopy

4

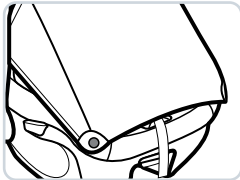

Attach magnets to front of car seat

## Removing Seat Pads

i

You do not need to remove the harness system to remove the pad from the car seat.

**DO NOT** fully pull the harness strap out of the car seat. Leave it threaded in the hip harness slots. If removed, you will not be able to rethread it.

To remove accessories, see page 3.

1

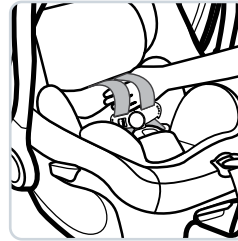

**Fully Loosen Harness Straps**

Push down on the harness release lever (through the opening in the pad) while pulling at or below the harness straps as shown.

2

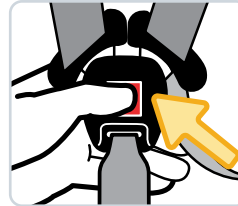

**Undo Buckle and Undo Chest Clip**

Press the red button to unbuckle the harness.

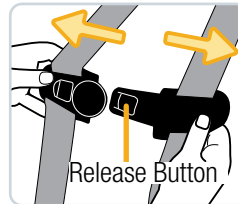

Hold each side of the chest clip.

Press the release button with your thumb.

Pull the chest clip and release button apart.

3

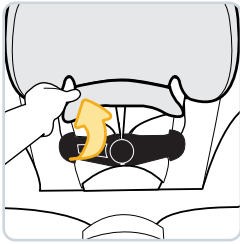

**Undo Fasteners on Headrest Pad and Gently Pull Headrest Pad Off Top of Headrest**

4

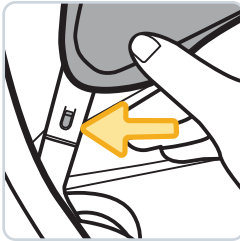

**Remove Canopy**  
See page 44.

5

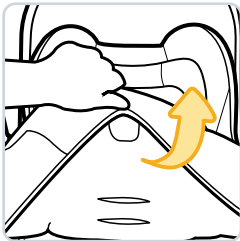

**Pull Seat Pad Off Sides and Bottom of Car Seat**

6

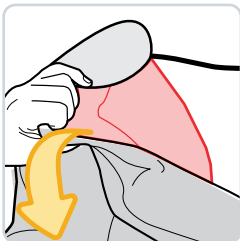

**Pull Seat Pad Around Headrest and Off Car Seat**

## Cleaning Seat Pad and Accessories

**You MUST turn car seat pad inside-out before machine washing.** Machine wash separately with cold water on gentle cycle. **DO NOT** use bleach. Tumble dry separately for 10–12 minutes on low heat. Remove immediately.

## Cleaning Harness Strap

**Check the harness straps often for any wear or damage.**

Spot clean using warm sudsy water and damp cloth. Spilled food and liquids on the car seat may result in mold or bacterial growth over time. These spills could also attract insects or rodents.

## Cleaning Buckle and Car Seat

Spot clean using warm sudsy water and a damp cloth. **DO NOT** submerge into water.

## Installing Seat Pad

1. Lower headrest to middle of car seat.
2. Pull seat pad around headrest.
3. Pull seat pad around sides and front of car seat.
4. Adjust headrest to highest position.
5. Pull headrest pad onto headrest.
6. Attach all pad fasteners.
7. Reattach canopy to car seat.

## **⚠️ WARNING**

**DO NOT** use the child restraint without the seat pad or with damaged harness straps. Failure to do this can result in death or serious injury. Serious injury may include paralysis and/or permanent brain injury.

## LATCH: Lower Anchor Belt

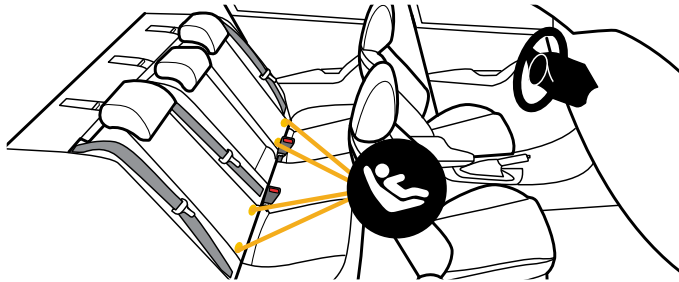

Your vehicle's features may be considerably different than those pictured here.

The lower anchors of **LATCH** (**L**ower **A**nchors and **T**ethers for **C**hildren) is a universal system for installing car seats without using vehicle seat belts. The LATCH: lower anchor belt can **ONLY** be used in vehicles that have the lower anchor bars installed in designated seating positions. Most vehicles manufactured after September 2002 are equipped with LATCH: lower anchor bars. Check your vehicle owner's manual to see which seating positions may be equipped with LATCH: lower anchor bars.

### Lower Anchor Belt Parts

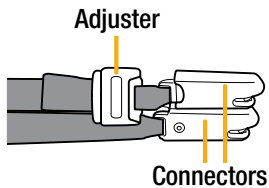

### Lower Anchor Belt Storage Location

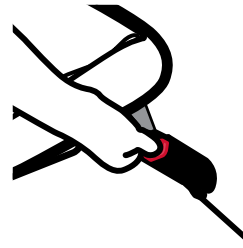
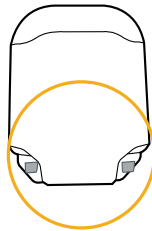

### To Remove Lower Anchor Belt from Vehicle's Lower Anchor Bars

1. Remove the tension from the belt by pushing down on the side of the car seat with the adjuster.
2. Press the adjuster's button to loosen the belt.
3. Press the release button on each connector, then pull the connectors out of the vehicle seat.

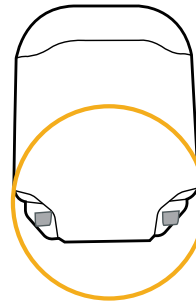

### To Store Lower Anchor Belt

The lower anchor belt **MUST** be properly stored in its storage location when:

- using the vehicle belts to install the base; **OR**
- the base is not installed in a vehicle.

Gather the lower anchor belt and place it into the storage location as shown.

## **⚠ WARNING**

**DO NOT** use both the lower anchor belt and vehicle belt at the same time.

## Vehicle Belts

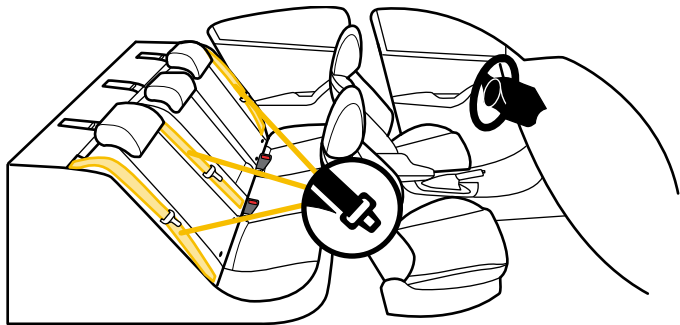

Your vehicle's features may be considerably different than those pictured here.

If LATCH: lower anchors are not an option in **Rear-Facing Mode** you **MUST** use the vehicle seat belt system to install the car seat.

**Not all vehicle belts and seating positions will work with car seats. Please go through the following steps to understand how to lock a car seat in **Rear-Facing Mode** with a vehicle belt.**

1

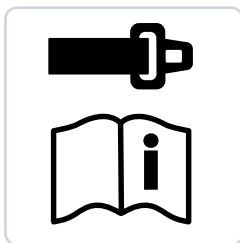

### You **MUST** Review Your Vehicle Owner's Manual

Check your vehicle owner's manual to determine the type of vehicle belts in your car and the seating positions available for installing the car seat.

2



### Check How This Car Seat Will Be Locked Into Place

The vehicle belt **MUST NOT** loosen after tightening.

This means there needs to be a way to lock the vehicle belt.

**This can be done by using either:**

- The vehicle belt's retractor (see step 3); **OR**
- The vehicle belt's latch plate (see step 4).

3

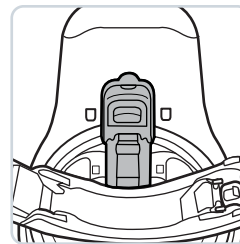

### Lock Off

The vehicle belt retractor **MUST** be locked after closing the lock off.

Please go to the vehicle belt with base installation section of the manual to see how to properly use this feature.

Base Install with Vehicle Belt: **Page 5**

4

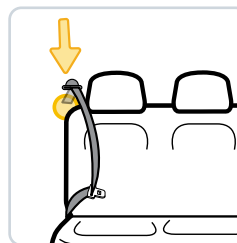

### Check Retractor

Retractors pull vehicle belts into stored positions and lock the belt to hold passengers in place.

See the next page for some common types of vehicle belt retractors that will work with this car seat.

## Types of Retractors



### Switchable Retractor (most vehicles have this type)

This retractor can be switched to a locking mode.

You **MUST have the retractor in the locking mode** to use the vehicle belt with this car seat.

**Switching to locking mode:** Slowly pull the shoulder belt all the way out, then let it retract **1–2 in.** (2.5–5 cm).

As it retracts, you will most likely hear a ratcheting sound.

Gently pull the belt to see if it is locked. You will not be able to pull any more belt out once the lock has engaged.

### Automatic Locking Retractor



This retractor always locks.

It will automatically lock after slowly pulling the vehicle belt out at least halfway and letting the belt go back into the retractor **1–2 in.** (2.5–5 cm).



### Emergency Locking Retractor

#### See Step 5 Check Latch Plates

If the retractor does not lock, it is most likely an Emergency Locking Retractor. These retractors only lock during a sudden stop or collision.

You will need to determine if your vehicle belt's latch plate can lock the belt. See step 5, Check Latch Plates.

5

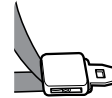

Locking  
Latch  
Plate



Sliding Latch  
Plate

### Check Latch Plates

Latch plates are the part of the seat belt that goes into the buckle.

#### To see if the latch plate locks:

1. Buckle vehicle belt.
2. Slowly pull up on the lap portion of the vehicle belt.

If the vehicle belt does not slide through the latch plate, it is locked.

If the latch plate slides up and down the vehicle belt, it is a **sliding latch plate**.

Sliding latch plates easily slip between the lap and shoulder portions of the belt.



## Never Use the Following With This Car Seat:

- Emergency Locking Retractor Lap Only Belt
- Inflatable Seat Belts

## ⚠️ WARNING

**NEVER** take your child out of the child restraint while the vehicle is moving.

**NEVER** leave your child unattended.

Placing your child in a hot child restraint may result in burns.

**DO NOT** use a child restraint with damaged or missing parts.

**DO NOT** use a child restraint with cut, frayed, or damaged harnesses.

**DO NOT** substitute parts or try to modify the child restraint in any way. **DO NOT** lubricate buckles and fasteners.

**DO NOT** use any child restraint accessory except those approved by Dorel Juvenile Group.

**NEVER** allow any child to play with this child restraint; it is not a toy.

**DO NOT** remove or cover up any of the warning labels or other labels on the child restraint.

This child restraint has been certified for use in passenger vehicles. **DO NOT** use in a boat, on a motorcycle, or in a cargo van or bus where there are no seat belts or tether anchors.

Read all instructions for additional warnings.

## ⚠️ WARNING



**NEVER** place a child rear-facing in a seating position with an active frontal air bag.

Check the vehicle owner's manual for more information about air bag/child restraint use.



Use the child restraint only on vehicle seats that face forward.



**DO NOT** use on seats that face the sides or rear of the vehicle.

For vehicles without a back seat, refer to your vehicle owner's manual.



**According to accident statistics, children are safer when properly restrained in the rear seating positions than in the front seating positions.**

**Rear seating positions are statistically safer, whether you have air bags, advanced air bags, or no air bags at all.**

**If you are not sure where to place the car seat in your vehicle:**

- Consult your vehicle owner's manual; **OR**
- Contact Dorel Juvenile Group Consumer Care Department; **OR**
- Visit your local Child Passenger Inspection Station. Go to <https://www.nhtsa.gov/equipment/car-seats-and-booster-seats> to find your closest station.

**To avoid your child being seriously burned, take the following precautions:**

- Park in the shade or where the sun does not directly hit the car seat.
- Cover the car seat with a sheet or blanket when not in use.
- Check for hot seat and buckles before placing child in car seat.

**To help protect your vehicle seat's upholstery from damage:** you may use an accessory approved by Dorel Juvenile Group or a single layer towel underneath and behind car seat.

### **WARNING**

Check the vehicle belt or lower anchor belt before each use. Use only if the belt can be tightened properly and locked securely in place.

Even when unoccupied, this child restraint **MUST** be firmly secured to the vehicle with the lower anchor belt or with the vehicle seat belt.

In a crash or sudden stop, an unsecured child restraint could injure occupants.

### **DO NOT risk your child's safety.**

To keep your child as safe as possible, Dorel Juvenile Group strongly recommends replacing the car seat even after a minor crash, even if it was not occupied at the time.

### **Replacement After a Minor Crash**

The National Highway Traffic Safety Administration states that for a crash to be considered minor **ALL of the following MUST be true:**

- Vehicle able to drive away from the crash site; **AND**
- Vehicle door nearest the car seat was not damaged; **AND**
- No passengers were injured; **AND**
- Airbags did not deploy; **AND**
- There is no visible damage to the car seat.

If the crash your car seat was involved in meets **ALL** the criteria, you may not need to replace the car seat.

If one or more of these criteria are not true or if you are uncertain of any of your answers, replace the car seat immediately.

### **Replacement After a Moderate to Severe Crash**

You **MUST** replace this car seat if it has been in a moderate to severe car crash.

This car seat is intended to protect a child in a single crash. During a crash, the car seat and all of its parts absorb crash energy which can deform or weaken it. Damage is not always visible. A damaged car seat **MUST** be replaced immediately.

### **Expiration**

On the bottom of the car seat there is a date of manufacture label as shown.

**DO NOT** use this car seat more than 8 years after the date of manufacture.

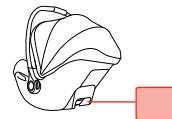

0515079 *Tear Off and Mail This Part or Register Online* 4348-0081D

**Consumer:** Just fill in your name, address and email. Please print (use dark ink).

Your Name

Your Street Address

City State Zip Code

Email Address (optional)

Model Number	Model Name	Manufacture Date
AB123CDE	Brand Car Seat	2024/05/16

Barcode: L#11 B265035

Example of model number, manufacture date, and line code.

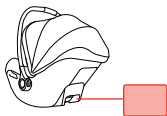

If you don't have the card or if your address changes, you will find the model number, manufacture date, and line code on the label located on the bottom of the car seat.

Please complete the postage-paid registration card that came with your child restraint, and send it to us.

Child restraints could be recalled for safety reasons.

You must register this restraint to be reached in a recall.

Send your name, address, email address if available, and the restraint's model number and manufacturing date to:

### Dorel Juvenile Group

P.O. Box 2609  
Columbus, IN 47202

or call 1-800-951-4113 or register online at [www.djgusa.com/registration/carseat/us](http://www.djgusa.com/registration/carseat/us).

For recall information, call the U.S. Government's Vehicle Safety Hotline at 1-888-327-4236 (TTY: 1-800-424-9153), or go to [www.NHTSA.gov](http://www.NHTSA.gov).



This restraint is certified for aircraft use when used with the internal harness.

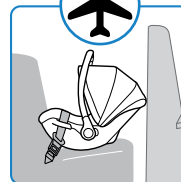

### Rear-Facing Aircraft Installation

Follow the steps on pages 28–32.

You can only install this child restraint in an aircraft without the base.

Install the car seat in a window seat to avoid blocking the aisle. If the aircraft lap belt is too short, ask the flight attendant for a belt extender. Use only on forward-facing aircraft seats. Contact the airline for their specific policies.

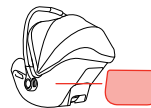

Some airlines may ask to see a label stating that this car seat is certified for aircraft use.

There is an airplane certification label located on the back of this car seat as shown.

## ⚠️ WARNING

You **MUST** store the LATCH belt when installing with aircraft belts.

Dorel Juvenile Group, Inc. (DJG) warrants this product to the original retail purchaser as follows: This product is warranted against defective materials or workmanship for one year from the date of original purchase. **An original receipt is required to validate your warranty.** DJG will, at its option, provide replacement parts or replace this product. DJG reserves the right to substitute if the part or model has been discontinued.

To make a claim under this warranty contact our Consumer Care Department by phone at 1-800-544-1108; or text us at 1-812-652-2525. Our hours of operation are from 8:00 a.m. to 6:00 p.m. ET Monday through Thursday and from 8:00 a.m. to 4:30 p.m. on Friday.

**Proof of purchase is required and shipping charges are the responsibility of the consumer.**

**Warranty Limitations:** This warranty does not include damages which arise from misuse or abuse of this product.

**Limitation of Damages:** The warranty and remedies as set forth are exclusive and in lieu of all others, oral or written, expressed or implied. In no event will DJG or the dealer selling this product be liable to you for any damages, including incidental or consequential damages, arising out of the use or inability to use this product.

**Limitation of warranties and other warranty terms and state law rights:** Any implied warranties, including implied warranties of the merchantability and fitness for a particular purpose, shall be limited to the duration and terms of the express written warranty. Some states do not allow limitations as to how long an implied warranty lasts or the exclusion or limitation of incidental or consequential damages, so the above limitations may not apply to you.

This warranty gives you specific legal rights, and you may have other rights, which vary from state to state. Neither DJG nor the dealer selling this product authorized any person to create for it any other warranty, obligation, or liability in connection with this product.

**Please note:** Our product warranty only applies when purchased from an authorized Maxi-Cosi retailer. The origin of products not purchased through these authorized retailers is unknown and could be counterfeit. We cannot support products from an unknown origin as we cannot verify the handling or condition of such merchandise. We maintain a strong network of authorized retailers to ensure you are purchasing safe and complete products. Fulfillment by a third party does not guarantee you are purchasing from one of these authorized retailers. Pricing which is inconsistent with the majority of retailers is a strong indication that the retailer is not authorized, as we have a consistent price offering across all authorized retailers. If you are unsure of the authorization status of a retailer you are considering purchasing from, or have purchased from, you can check [www.maxicosi.com/us-en/shops.aspx](http://www.maxicosi.com/us-en/shops.aspx); or call our Consumer Care Department at 1-800-544-1108; or text us at 1-812-652-2525.