

### Features

- Two Lever handles offer separate control of hot and cold water
- KOHLER® ceramic disc valves exceed industry longevity standards for a lifetime of durable performance
- Coordinate with your choice of Components bath spouts for a personalized design
- Coordinates with Components faucets, accessories, and showering components to complete your bathroom

### Material

- Premium metal construction for durability and reliability
- KOHLER finishes resist corrosion and tarnishing

### Installation

- Deck-mount
- Valves included

### Required Products/Accessories

For deck-mount installation

- K-77985 deck-mount bath spout with Tube design
- K-77986 deck-mount bath spout with Ribbon design
- K-77987 deck-mount bath spout with Row design

### Recommended Products/Accessories

- K-78372 18" Towel Bar
- K-78373 24" Towel Bar
- K-78375 24" Double Towel Bar
- K-78377 Hand Towel Arm
- K-78378 Robe Hook
- K-78379 Double Towel Arm
- K-78382 Pivoting toilet paper holder
- K-78383 Vertical toilet paper holder
- K-78384 Covered double toilet paper holder



ADA CSA B651 OBC

### Codes/Standards









ASME A112.18.1/CSA B125.1  
 ADA  
 ICC/ANSI A117.1  
 CSA B651  
 OBC  
 NOM Standards  
 NOM 012-CONAGUA

### KOHLER® Faucet Lifetime Limited Warranty

See website for detailed warranty information.

### Available Colors/Finishes

*Color tiles intended for reference only.*

Color	Code	Description
	CP	Polished Chrome
	SN	Vibrant® Polished Nickel
	AF	Vibrant® French Gold
	BN	Vibrant® Brushed Nickel
	BV	Vibrant® Brushed Bronze
	BL	Matte Black
	2MB	Vibrant® Brushed Moderne Brass
	TT	Vibrant Titanium
	BGP	Vibrant Brushed Graphite

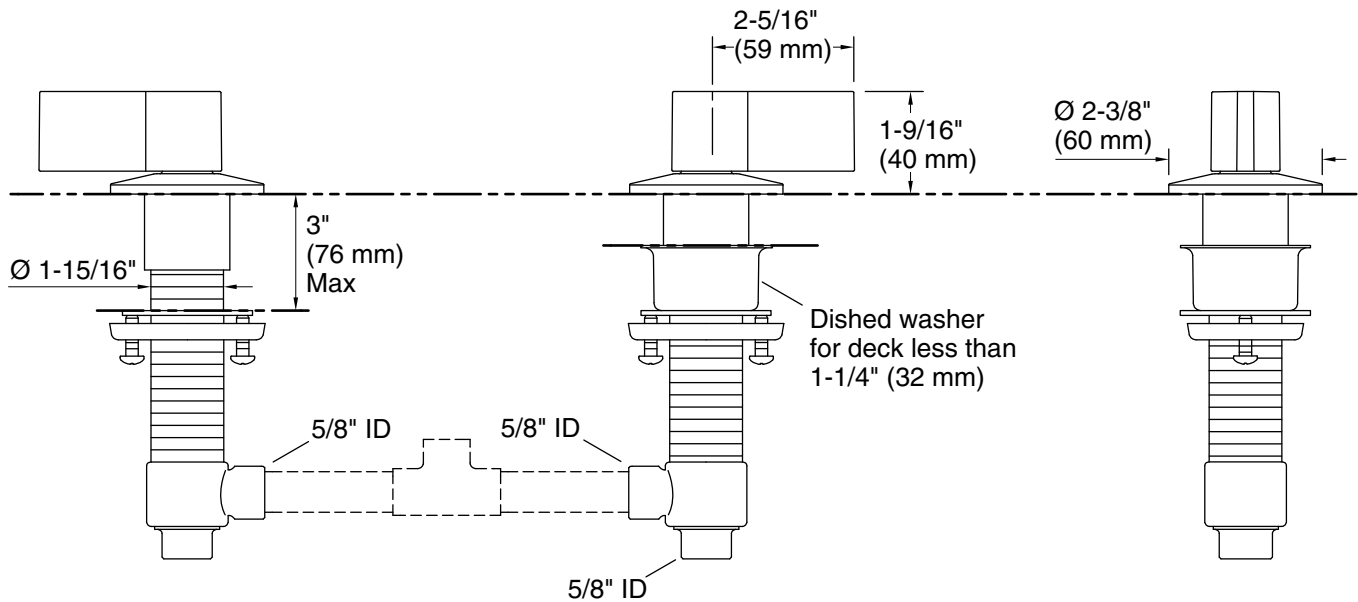

### Technical Information

All product dimensions are nominal.

### Spout:

### Notes

Install this product according to the installation instructions.

ADA compliant for handles only.

ADA, OBC, CSA B651 compliant when installed to the specific requirements of these regulations.