



**MANUFACTURED BY:**  
**Backyard Discovery**  
 3305 Airport Drive, Pittsburg, KS 66762  
 800-856-4445

Basepoint Business Centre: Rivermead Drive, Westlea, Swindon SN5 7EX Phone: 0800-118-2476  
 J.P. Coenstraat 7, The Bridge, The Hague, 2595 WP, Netherlands Phone: 0800-567-8990

# HILLCREST

## Swing Set

### Model # 1808058B



**WARNING**

**Adult Assembly Required.**

Not suitable for children under 36 months due to small parts.

**FOR DOMESTIC USE ONLY. INTENDED FOR OUTDOOR USE.**



**Please visit [www.backyarddiscovery.com](http://www.backyarddiscovery.com)**

For the most up to date assembly manual, to register your set, or to order replacement parts

*Para obtener instrucciones en español, visite [www.backyarddiscovery.com](http://www.backyarddiscovery.com)*



**EASY STEP-BY-STEP**  
**3D INTERACTIVE INSTRUCTIONS**

DOWNLOAD THE FREE APP



**INSTALLATION SERVICES AVAILABLE!**  
*See inside for details*

# Owner's Manual - Basic Setup Dimensions & Assembly Notes

Place the set on level ground, not less than 6'-7" [2 m] from any structure or obstruction such as a fence, garage, house, overhanging branches, laundry lines, or electrical wires.

- While assembling unit, take time before and after each phase to make sure fort is level. If fort is not level, assembly will be difficult and improper assembly may result. Extra care must be taken to insure the fort is square.
- The safe play area refers to a zone extending 6'-7" (2 m) beyond the play product on all sides, including the space above the play product.

## SAFE PLAY AREA DIAGRAM

### Ground Dimensions

18'-3 3/4" [5.6 m] x 13'-5 1/2" [4.1 m]

### Safe Play Area

31'-5 3/4" [9.6 m] x 26'-7 1/2" [8.1 m] x 16'-1 1/4" [4.9 m]

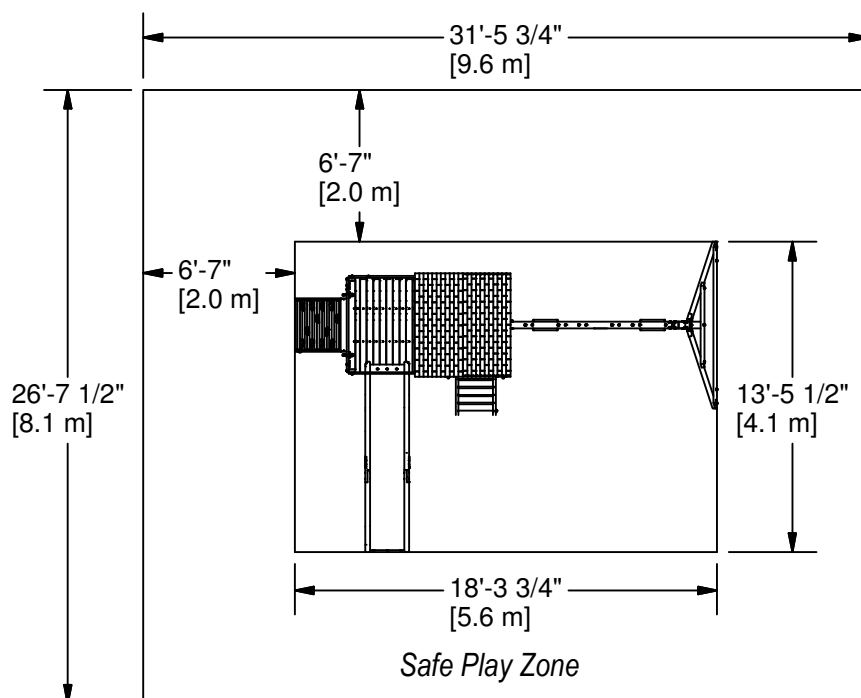

SAFE PLAY HEIGHT: 16'-1 1/4" [4.9 m]  
MAXIMUM FALL HEIGHT: 6'-11 1/4" [2.1 m]

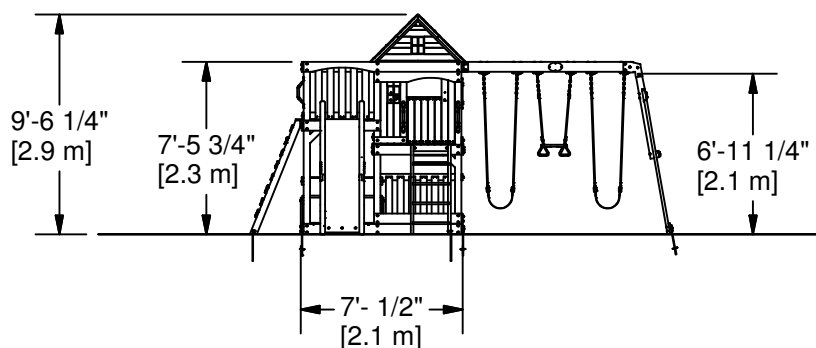

### General Information:

Your set has been designed and engineered for children only and for residential use only.  
A maximum of 150 lbs. per child is recommended for play activities designed for individual use.  
A maximum of 120 lbs. per child is recommended for play activities designed for multiple child use.  
A maximum of 9 children is recommended for this swing set.

# Owner's Manual - Parts Identification

## Wood Components (Not to Scale)

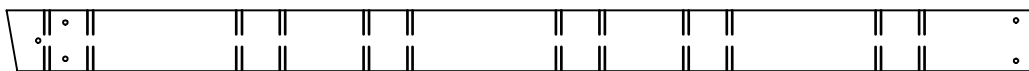

**A50 | SWING BEAM - W4L15998**  
(x1) | 3 3/8"x5 1/4"x89 1/2" (86x134x2274)

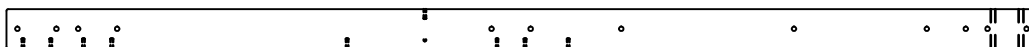

**E01 | RIGHT FRONT TOWER LEG - W4L15999**  
(x1) | 1 3/8"x3 3/8"x89 1/2" (36x86x2274)

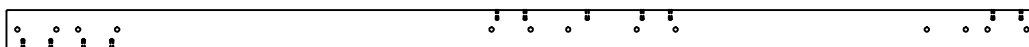

**E02 | CENTER FRONT TOWER LEG - W4L16000**  
(x1) | 1 3/8"x3 3/8"x89 1/2" (36x86x2274)

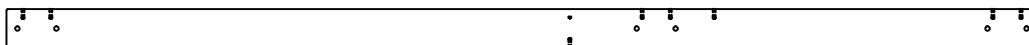

**E03 | LEFT FRONT TOWER LEG - W4L16001**  
(x1) | 1 3/8"x3 3/8"x89 1/2" (36x86x2274)



**E04 | DECK BRACE - W4L16002**  
(x8) | 1 3/8"x3 3/8"x15 1/2" (36x86x394)

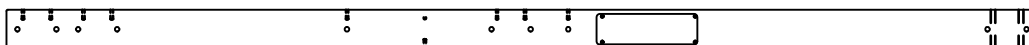

**E05 | RIGHT REAR TOWER LEG - W2A03282**  
(x1) | 1 3/8"x3 3/8"x89 1/2" (36x86x2274)

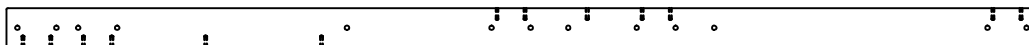

**E06 | CENTER REAR TOWER LEG - W4L16005**  
(x1) | 1 3/8"x3 3/8"x89 1/2" (36x86x2274)

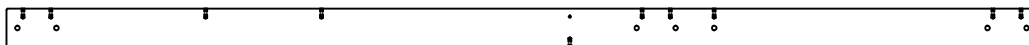

**E07 | LEFT REAR TOWER LEG - W4L16006**  
(x1) | 1 3/8"x3 3/8"x89 1/2" (36x86x2274)

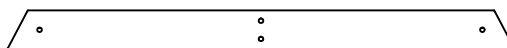

**E50 | END SUPPORT - W4L16003**  
(x1) | 1 3/8"x3 3/8"x44 1/8" (36x86x1120)

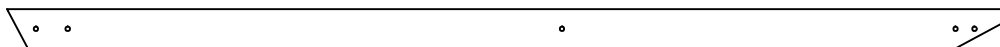

**E51 | ANGLE BRACE - W4L16004**  
(x2) | 1 7/16"x3 3/8"x87 3/16" (36x86x2214)



**E72 | LEFT RAIL - W4L16007**  
(x1) | 1 3/8"x3 3/8"x64 1/2" (36x86x1640)

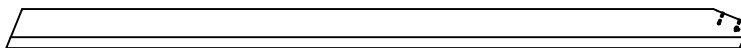

**E73 | RIGHT RAIL - W4L16008**  
(x1) | 1 3/8"x3 3/8"x64 1/2" (36x86x1640)

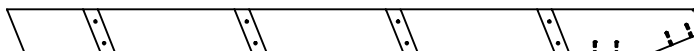

**E74 | LEFT UPRIGHT - W4L16028**  
(x1) | 1 3/8"x3 3/8"x50 3/4" (36x86x1290)

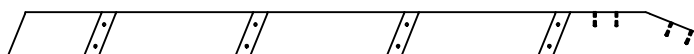

**E75 | RIGHT UPRIGHT - W4L16029**  
(x1) | 1 3/8"x3 3/8"x50 3/4" (36x86x1290)

# Owner's Manual - Parts Identification

## Wood Components (Not to Scale)

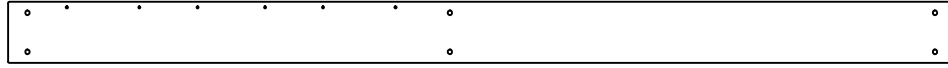

**G01 | BASE BOARD - W4L16009**  
(x2) | 5/8"x5 1/4"x82 1/4" (16x134x2088)

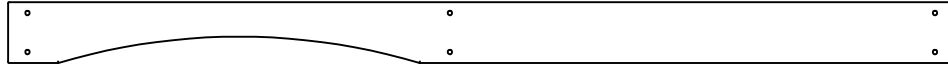

**G02 | WALL RAIL - W4L16015**  
(x1) | 1"x5 1/4"x82 1/4" (24x134x2088)

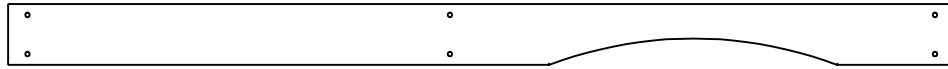

**G03 | WALL RAIL - W4L16016**  
(x1) | 1"x5 1/4"x82 1/4" (24x134x2088)



**G04 | FLOOR RAIL - W4L16017**  
(x2) | 5/8"x5 1/4"x49" (16x134x1244)



**G05 | WALL RAIL/SWING MOUNT - W4L16018**  
(x1) | 1"x5 1/4"x49" (24x134x1244)

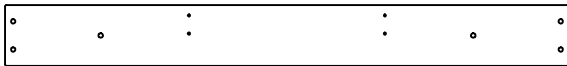

**G06 | FLOOR RAIL - W4L16020**  
(x1) | 1"x5 1/4"x49" (24x134x1244)

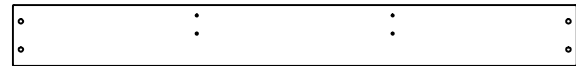

**G07 | FLOOR RAIL - W4L16021**  
(x2) | 1"x5 1/4"x49" (24x134x1244)



**G08 | WALL RAIL - W4L16022**  
(x2) | 1"x5 1/4"x49" (24x134x1244)



**G09 | FLOOR RAIL - W4L16036**  
(x1) | 1"x5 1/4"x49" (24x134x1244)



**G10 | FLOOR RAIL - W4L16010**  
(x1) | 1"x5 1/4"x45 1/2" (24x134x1156)

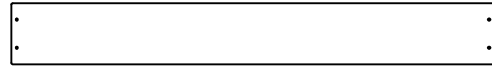

**G11 | PICNIC TABLE TOP - W4L16011**  
(x2) | 5/8"x5 1/4"x42" (16x134x1066)

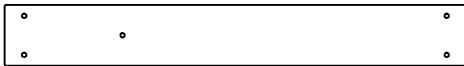

**G12 | FLOOR RAIL - W4L16012**  
(x2) | 1"x5 1/4"x40 1/8" (24x134x1018)

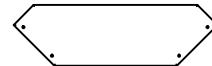

**G13 | SAND BOX SEAT - W4L16013**  
(x2) | 1"x5 1/4"x17 3/4" (24x134x450)

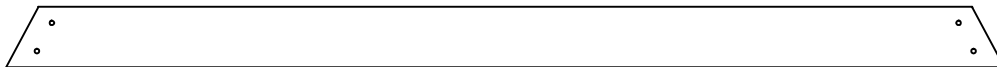

**G14 | GROUND BOARD - W4L16019**  
(x1) | 15/16"x5 1/4"x86 11/16" (24x134x2202)

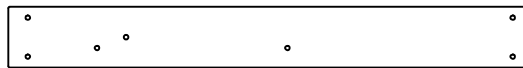

**G15 | FLOOR RAIL - W4L16014**  
(x1) | 1"x5 1/4"x45 1/2" (24x134x1156)

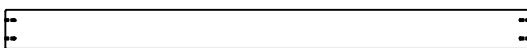

**H01 | FLOOR JOIST - W4L16023**  
(x2) | 1"x3 3/8"x45 1/2" (24x86x1156)

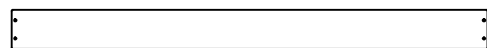

**H02 | PICNIC TABLE SEAT - W4L16025**  
(x2) | 1"x3 3/8"x41 3/8" (24x86x1050)



**H03 | FLOOR JOIST - W4L16026**  
(x2) | 1"x3 3/8"x40 1/8" (24x86x1018)

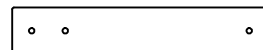

**H04 | SEAT UPRIGHT - W4L16027**  
(x2) | 1"x3 3/8"x19" (24x86x482)

# Owner's Manual - Parts Identification

## Wood Components (Not to Scale)



**H05** | **BOTTOM FLOOR BOARD SUPPORT - W4L16024**  
(x10) | 1"x3 3/8"x5 1/4" (24x86x134)

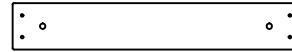

**H06** | **LADDER MOUNT - W4L16088**  
(x1) | 1"x3 3/8"x21" (24x86x532)

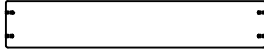

**H07** | **LADDER RUNG - W4L16030**  
(x4) | 15/16"x3 3/8"x18 7/8" (24x86x480)

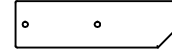

**H08** | **TABLE SUPPORT - W4L16031**  
(x2) | 1"x3 3/8"x12" (24x86x306)

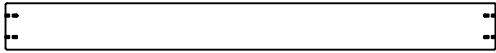

**H09** | **FLOOR JOIST - W4L16032**  
(x2) | 1"x3 3/8"x35 3/4" (24x86x908)



**H10** | **ATTACHMENT BOARD - W4L16045**  
(x1) | 1"x3 3/8"x27 7/8" (24x86x707)

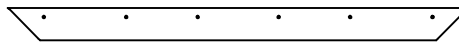

**J01** | **ROOF RAFTER - W4L16033**  
(x4) | 1"x2 3/8"x33 5/8" (24x60x854)



**K01** | **WALL RAIL - W4L16034**  
(x1) | 5/8"x5 1/4"x45 1/2" (16x134x1156)

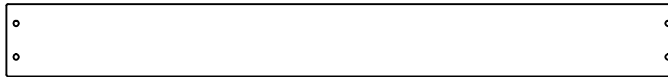

**K02** | **BASE/SAND BOX BOARD - W4L16035**  
(x3) | 5/8"x5 1/4"x49" (16x134x1244)

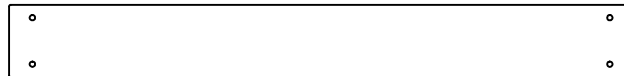

**K03** | **GROUND BOARD - W4L16038**  
(x2) | 5/8"x5 1/4"x45 1/2" (16x134x1156)

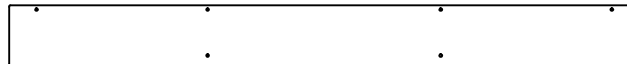

**L01** | **OUTSIDE FILLER FLOOR BOARD - W4L16039**  
(x3) | 5/8"x4 3/8"x46" (16x112x1168)

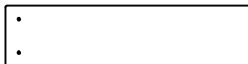

**L02** | **WALL BOARD - W4L16040**  
(x4) | 5/8"x4 3/8"x18" (16x112x456)

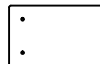

**L03** | **WALL BOARD - W4L16041**  
(x4) | 5/8"x4 3/8"x7" (16x112x178)

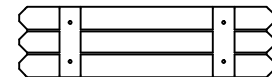

**L04** | **WINDOW SHUTTER - W4L16042**  
(x3) | 5/8"x4 3/8"x16" (16x112x406)



**M01** | **ROOF CAP - W4L16043**  
(x2) | 5/8"x3 3/8"x51 7/8" (16x86x1318)

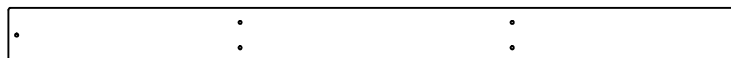

**M02** | **FLOOR BOARD - W4L16055**  
(x1) | 5/8"x3 3/8"x46" (16x86x1168)

# Owner's Manual - Parts Identification

## Wood Components (Not to Scale)



**M03** | FLOOR BOARD - W4L16063  
(x20) | 5/8"x3 3/8"x50 7/8" (16x86x1292)

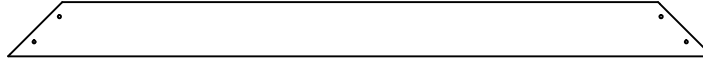

**M04** | GABLE BOARD - W4L16065  
(x2) | 5/8"x3 3/8"x44" (16x86x1118)

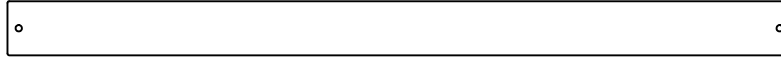

**M05** | WALL RAIL - W4L16066  
(x3) | 5/8"x3 3/8"x49" (16x86x1244)

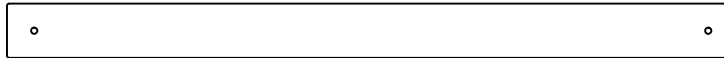

**M06** | WALL RAIL - W4L16067  
(x2) | 5/8"x3 3/8"x45 1/2" (16x86x1156)

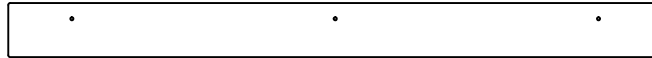

**M07** | WALL CAP - W4L16068  
(x2) | 5/8"x3 3/8"x40 7/8" (16x86x1038)

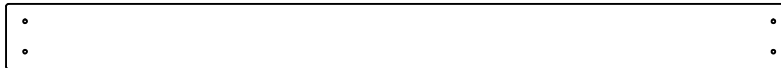

**M08** | WALL BOARD - W4L16074  
(x9) | 5/8"x3 3/8"x41" (16x86x1040)

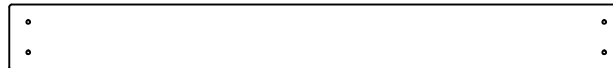

**M09** | WALL BOARD - W4L16075  
(x6) | 5/8"x3 3/8"x32" (16x86x812)



**M10** | WALL BOARD - W4L16044  
(x1) | 5/8"x3 3/8"x35" (16x86x888)



**M11** | WALL RAIL - W4L16047  
(x1) | 5/8"x3 3/8"x40 1/8" (16x86x1018)

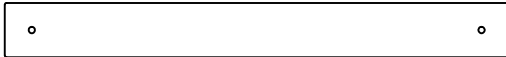

**M12** | WINDOW TRIM - W4L16048  
(x1) | 5/8"x3 3/8"x31 1/2" (16x86x800)



**M13** | WALL BOARD - W4L16049  
(x7) | 5/8"x3 3/8"x24" (16x86x610)

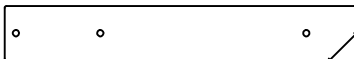

**M14** | PICNIC SEAT SUPPORT - W4L16050  
(x2) | 5/8"x3 3/8"x22" (16x86x558)

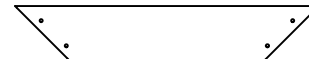

**M15** | GABLE BOARD - W4L16051  
(x2) | 5/8"x3 3/8"x19" (16x86x482)



**M16** | WALL BOARD - W4L16052  
(x2) | 5/8"x3 3/8"x21" (16x86x532)

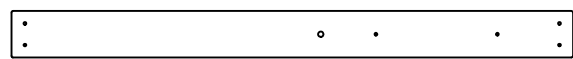

**M17** | WALL BOARD - W4L16090  
(x2) | 5/8"x3 3/8"x41" (16x86x1040)

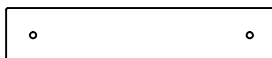

**M18** | WALL RAIL - W4L16053  
(x1) | 5/8"x3 3/8"x16 7/8" (16x86x430)

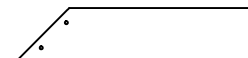

**M19** | GABLE BOARD - W4L16054  
(x4) | 5/8"x3 3/8"x15 1/4" (16x86x387)

# Owner's Manual - Parts Identification

## Wood Components (Not to Scale)

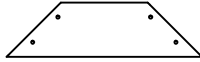

**M20** | GABLE BOARD - W4L16056  
(x2) | 5/8"x3 3/8"x12 1/4" (16x86x310)

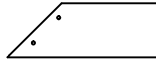

**M22** | GABLE BOARD - W4L16058  
(x4) | 5/8"x3 3/8"x9 1/2" (16x86x241)

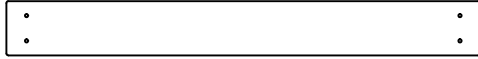

**M24** | WALL BOARD - W4L16061  
(x7) | 5/8"x3 3/8"x29 5/8" (16x86x752)



**M26** | WALL BOARD - W4L16091  
(x2) | 5/8"x3 3/8"x29 5/8" (16x86x752)



**M28** | WALL BOARD - W4L16064  
(x1) | 5/8"x3 3/8"x35" (16x86x888)

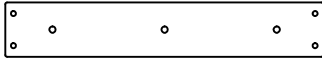

**M70** | SLIDE BED SUPPORT - W100935  
(x1) | 5/8"x3 3/8"x19 7/8" (16x86x505)

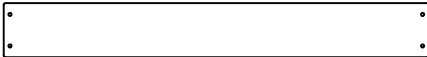

**M74** | ROCK WALL BOARD - W4L16071  
(x10) | 5/8"x3 3/8"x26 5/8" (16x86x675)

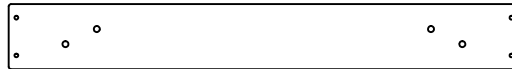

**M76** | ROCK WALL BOARD - W4L16073  
(x4) | 5/8"x3 3/8"x26 5/8" (16x86x675)

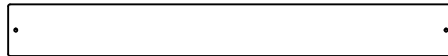

**M108** | TOP BOARD - W4L16046  
(x1) | 5/8"x3 1/4"x27 7/8" (16x82x707)



**N01** | FLOOR BOARD - W4L16076  
(x1) | 5/8"x2 3/8"x50 7/8" (16x60x1292)

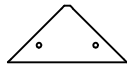

**N02** | MENDING PLATE - W4L16077  
(x2) | 5/8"x2 3/8"x5" (16x60x126)

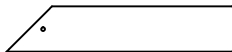

**N04** | GABLE BOARD - W4L16079  
(x4) | 5/8"x2 3/8"x11 7/8" (16x60x301)

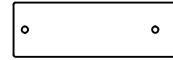

**M21** | WALL RAIL - W4L16057  
(x2) | 5/8"x3 3/8"x10 1/2" (16x86x268)

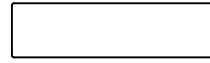

**M23** | WINDOW TRIM - W4L16059  
(x2) | 5/8"x3 3/8"x12 7/8" (16x86x328)

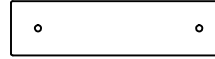

**M25** | TABLE SUPPORT - W4L16037  
(x2) | 5/8"x3 3/8"x13 1/2" (16x86x342)



**M27** | BOTTOM WALL BOARD - W4L16062  
(x13) | 5/8"x3 3/8"x21 3/8" (16x86x544)



**M29** | WALL BOARD - W4L16060  
(x2) | 5/8"x3 3/8"x5" (16x86x126)

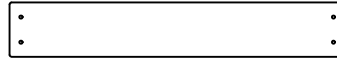

**M73** | REAR SUPPORT - W4L16070  
(x1) | 5/8"x3 3/8"x21" (16x86x532)

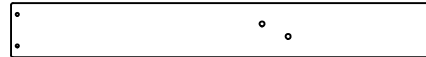

**M75** | ROCK WALL BOARD - W4L16072  
(x4) | 5/8"x3 3/8"x26 5/8" (16x86x675)



**N03** | WALL BOARD - W4L16078  
(x2) | 5/8"x2 3/8"x18" (16x60x456)



**N05** | WALL BOARD - W4L16080  
(x2) | 5/8"x2 3/8"x7" (16x60x178)

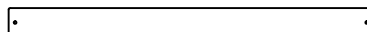

**N06** | FILLER BOARD - W4L16089  
(x1) | 5/8"x2 1/8"x26 5/8" (16x54x675)

# Owner's Manual - Parts Identification

## Wood Components (Not to Scale)



**O01** | WALL SUPPORT - W4L16081  
(x6) | 5/8"x1 3/8"x13" (16x34x330)

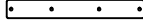

**O02** | WALL SUPPORT - W4L16082  
(x1) | 5/8"x1 3/8"x10" (16x34x254)



**O03** | SAFETY RAIL - W4L16083  
(x1) | 5/8"x1 3/8"x20 1/2" (16x34x520)



**O04** | WINDOW SHUTTER SLAT - W4L16084  
(x6) | 5/8"x1 3/8"x5 3/8" (16x34x136)

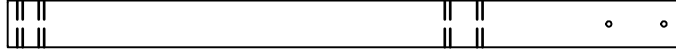

**SP50** | SWING BEAM SUPPORT - W4L16085  
(x1) | 3 3/8"x3 3/8"x49 3/8" (86x86x1254)



**T01** | SEAT SUPPORT - W4L16086  
(x4) | 1"x1 3/8"x4 3/8" (24x34x128)

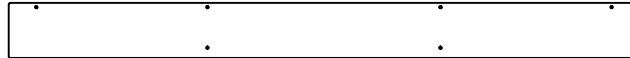

**Y01** | OUTSIDE FILLER FLOOR BOARD - W4L16087  
(x1) | 5/8"x4"x46" (16x102x1168)

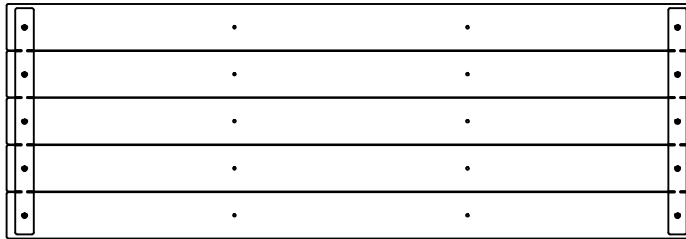

**FP1** | FLOOR PANEL - W2A03281  
(x1) | 1 5/8"x17 1/8"x50 1/4" (40x434x1276)

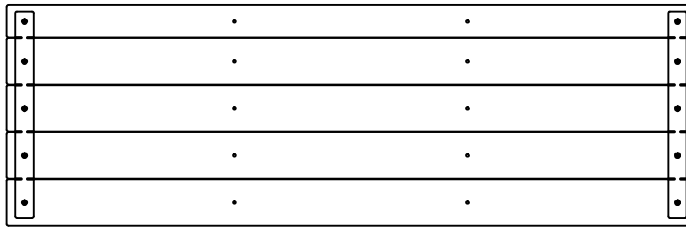

**FP2** | FLOOR PANEL - W2A03282  
(x1) | 1 5/8"x16 1/8"x50 1/4" (40x408x1276)

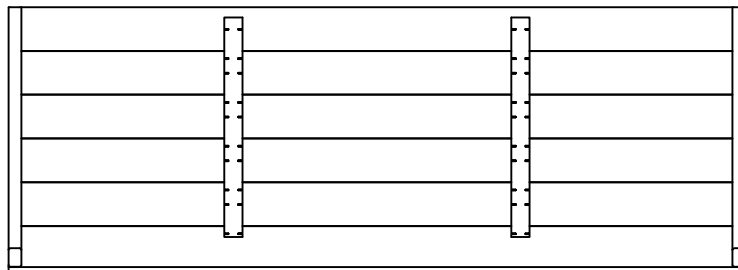

**RP1** | ROOF PANEL - W2A03279  
(x2) | 1 3/4"x19 1/4"x53 3/4" (45x490x1366)

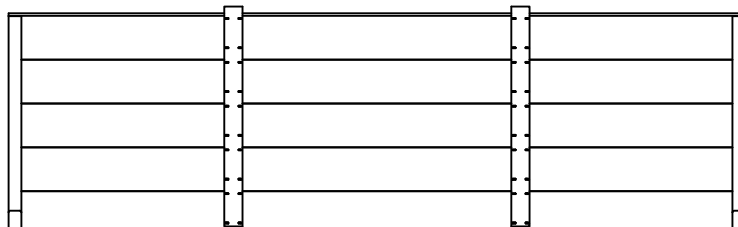

**RP2** | ROOF PANEL - W2A03280  
(x2) | 1 3/4"x16 1/4"x53 3/4" (45x417x1366)

# Owner's Manual - Parts Identification

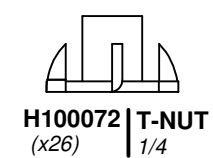
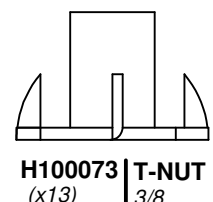
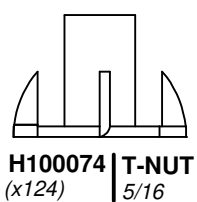
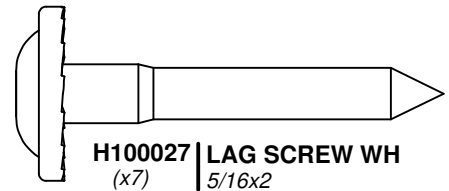
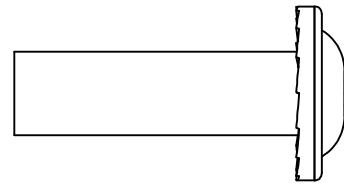
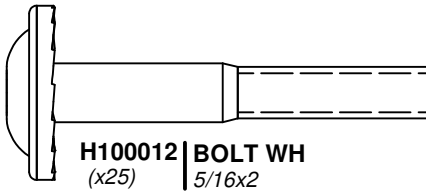
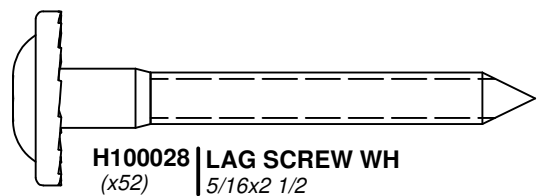
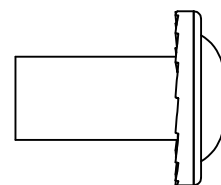
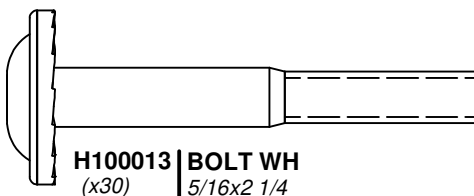
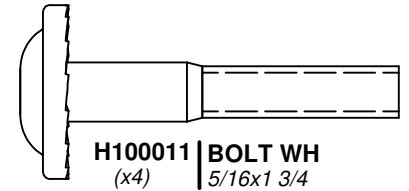
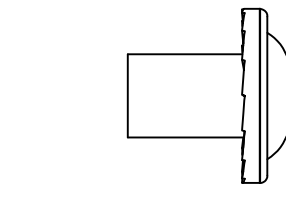
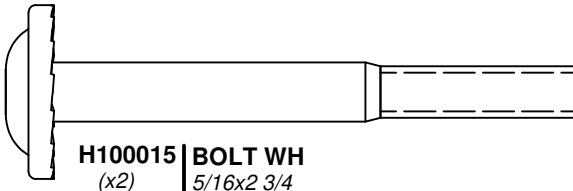
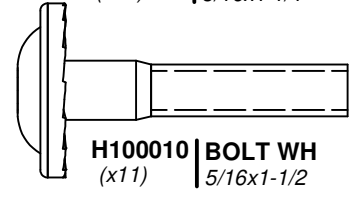
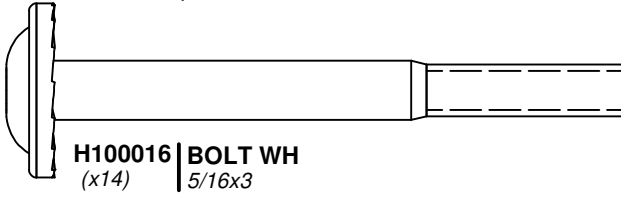
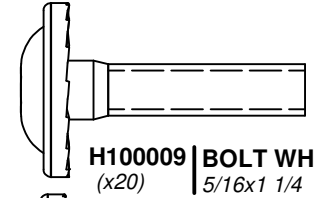
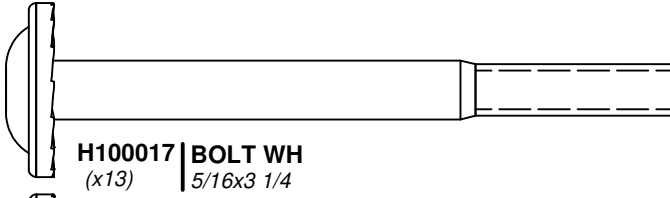
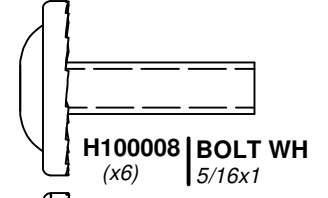
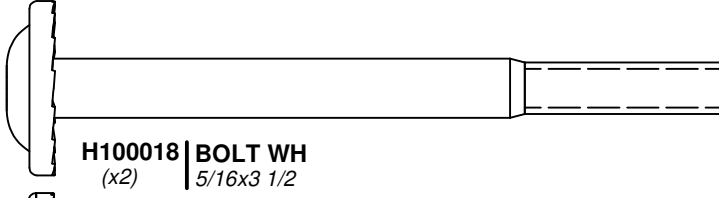
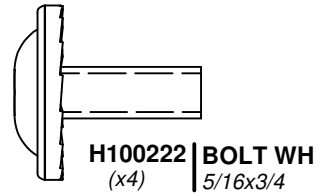
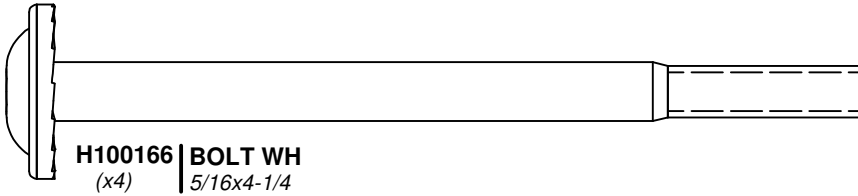
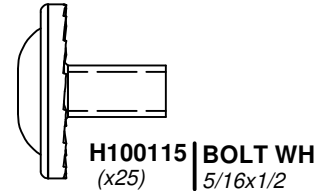
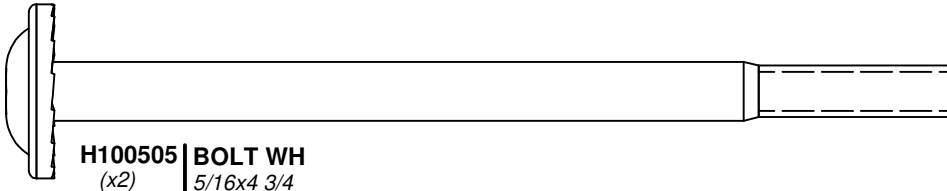

# Owner's Manual - Parts Identification

## Hardware Components

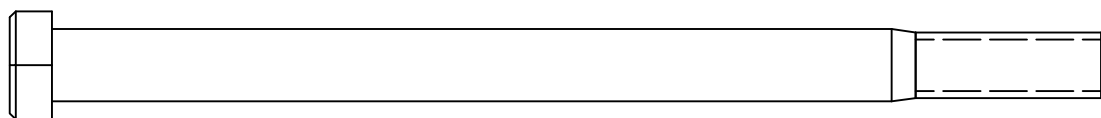

**H100654 | BOLT HEX**  
(x13) | 3/8x5-1/2

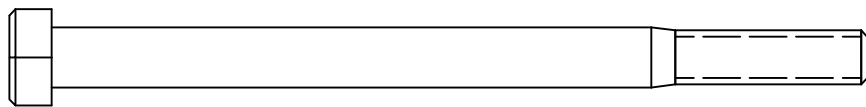

**H100054 | BOLT HEX**  
(x2) | 5/16x4 1/4



**H100063 | BOLT PTH**  
(x26) | 1/4x3/4

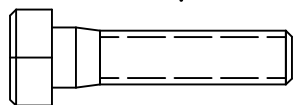

**H100042 | BOLT HEX**  
(x4) | 5/16x1 1/4

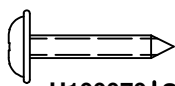

**H100070 | SCREW PWH**  
(x22) | 8x3/4

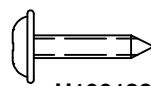

**H100128 | SCREW PWH**  
(x2) | 8x5/8

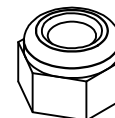

**H100110 | NUT LOCK**  
(x2) | 5/16

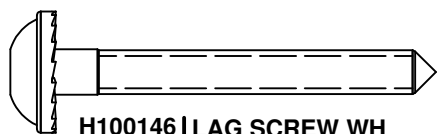

**H100146 | LAG SCREW WH**  
(x9) | 1/4x2

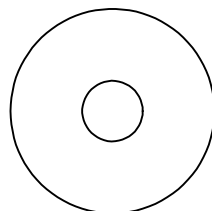

**H100105 | WASHER FLAT**  
(x9) | 8x27

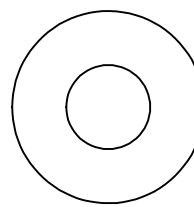

**H100102 | WASHER FLAT**  
(x13) | 11x25

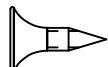

**H100124 | SCREW PFH**  
(x4) | 8 x 1/2

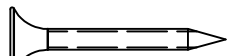

**H100088 | SCREW PFH**  
(x305) | 8x1 1/8

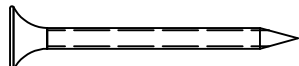

**H100086 | SCREW PFH**  
(x282) | 8x1 1/2

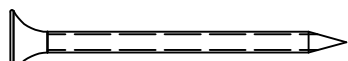

**H100089 | SCREW PFH**  
(x65) | 8x1 3/4

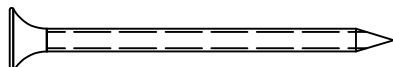

**H100111 | SCREW PFH**  
(x7) | 8x2

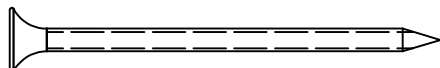

**H100091 | SCREW PFH**  
(x26) | 8x2 1/4

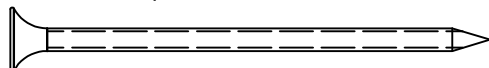

**H100090 | SCREW PFH**  
(x73) | 8x2 1/2"

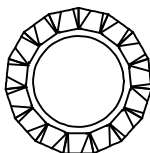

**H100031 | WASHER LOCK EXT**  
(x12) | 12x19

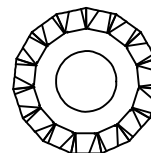

**H100030 | WASHER LOCK EXT**  
(x155) | 8x19

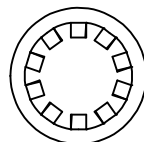

**H100107 | WASHER LOCK INT**  
(x13) | 10x18

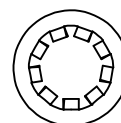

**H100108 | WASHER LOCK INT**  
(x26) | 8x15

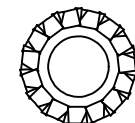

**H100138 | WASHER LOCK EXT**  
(x9) | 6x15

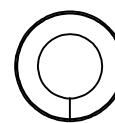

**H100095 | WASHER SPLIT**  
(x4) | 5/16



**H100764 | SCREW SETTER**  
(x1)

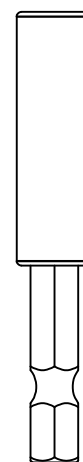

**H101100 | MAGNETIC DRIVER**  
(x1)

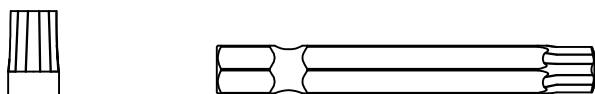

**A100042 | TORX BIT**  
(x1) | T-40

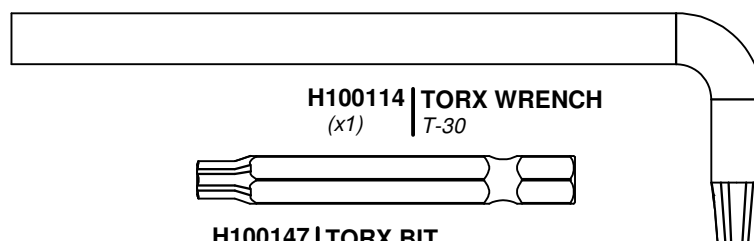

**H100114 | TORX WRENCH**  
(x1) | T-30

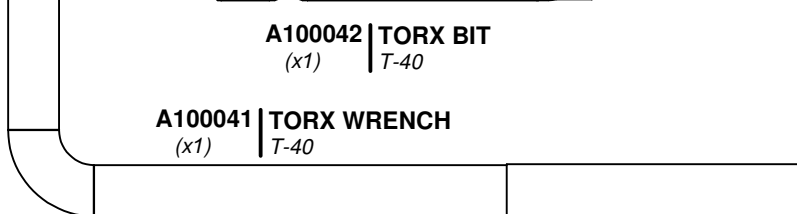

**A100041 | TORX WRENCH**  
(x1) | T-40

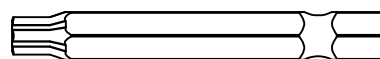

**H100147 | TORX BIT**  
(x1) | T-30

# Owner's Manual - Parts Identification

## Accessory Components (Not to Scale)



A100035 | SLIDE BED 10' LIGHT GREEN  
(x1)

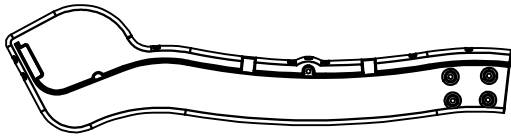

A6P00484 | SLIDE RAIL 10'  
BOTTOM RIGHT GREEN  
(x1)

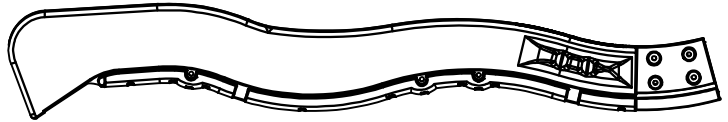

A6P00486 | SLIDE RAIL 10'  
TOP RIGHT GREEN  
(x1)

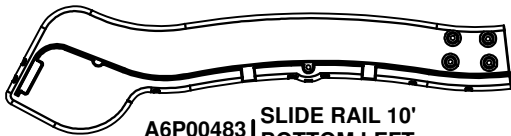

A6P00483 | SLIDE RAIL 10'  
BOTTOM LEFT GREEN  
(x1)

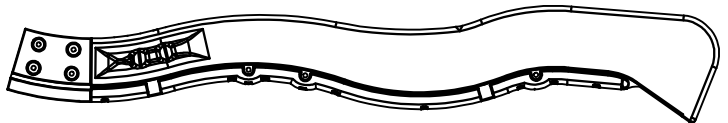

A6P00485 | SLIDE RAIL 10'  
TOP LEFT GREEN  
(x1)

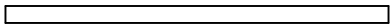

A6P00487 | SLIDE TUBE SUPPORT  
(x4)

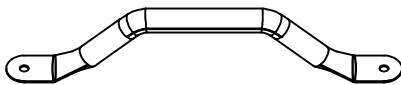

A100118 | HAND GRIP  
METAL GREEN  
381 c/c  
(x4)

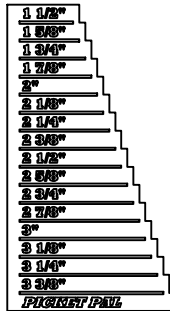

A6P00410 | PICKET PAL  
(x1)

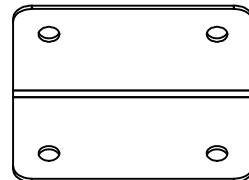

A100140 | L BRACKET  
(x2) | 66x66x127



A4M01046 | L BRACKET  
(x3) | 2.5x38x55x55

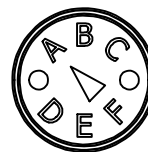

A100314 | "A" REVISION  
(x1) TAG

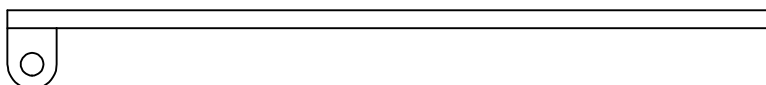

A4M00527 | GROUND STAKE  
(x2) REBAR



A100178 | AUGER GROUND  
(x6) STAKE

# Owner's Manual - Parts Identification

## Accessory Components (Not to Scale)

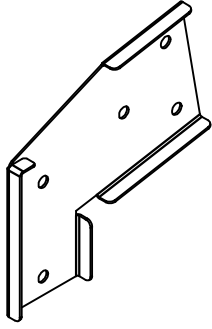

A100325  
(x1) | SWING BEAM  
EXTENSION  
BRACKET-LEFT

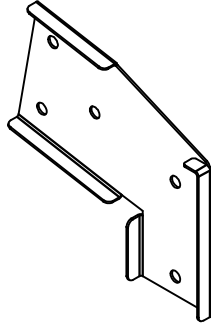

A100326  
(x1) | SWING BEAM  
EXTENSION  
BRACKET-RIGHT

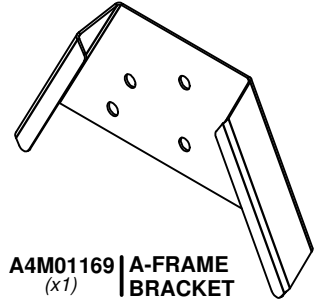

A4M01169 | A-FRAME  
(x1) | BRACKET



A100027 | SWING SEAT GREEN 26"  
(x2)

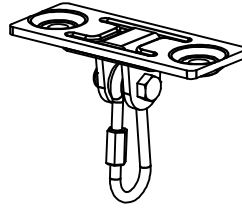

A4M00505 | SWING HANGER  
(x6)

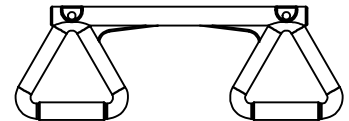

A6P00034 | TRAPEZE  
(x1) | YELLOW

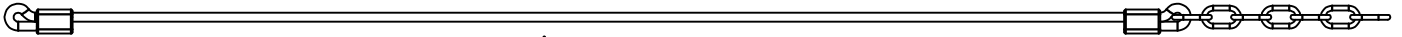

A100183 | ROPE-CHAIN GREEN 57"  
(x4)

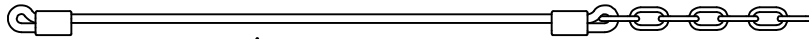

A100083 | ROPE-CHAIN GREEN 33"  
(x2)

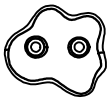

A6P00036 | GREEN HC ROCK #1  
(x6)

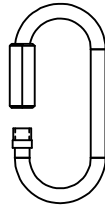

A100069 | QUICK LINK  
(x6)

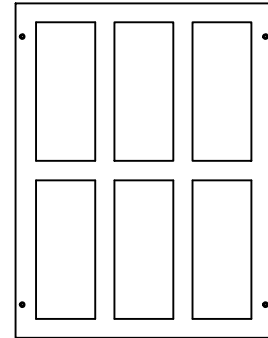

A100010 | PLASTIC WINDOW BYD GREEN 343x444.5  
(x2)



A6P00037 | GREEN HC ROCK #2  
(x6)



A100164 | BYD ID TAG  
(x1)

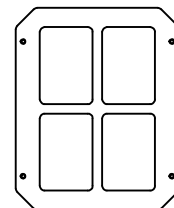

A100146 | WINDOW  
(x3) | 216x267 GREEN

# PRE-ASSEMBLY STEP 1 - SORTING PARTS

It is critical for ease of assembly that you take the time to sort and organize the wood and hardware.

---

## WOOD PARTS:

- Organize wood parts by the three-digit, alpha-numeric number stamped on each board (ex. P01).
- If there are multiple boards with the same stamped number, stack those pieces together.
- Stamps can be found on the flat surface of the boards or on the end of the boards.
- Allow yourself plenty of room - the wood pieces can take up a significant amount of space.

**NOTE: CARTONS ARE NOT ORGANIZED BY BOARD NUMBER.**

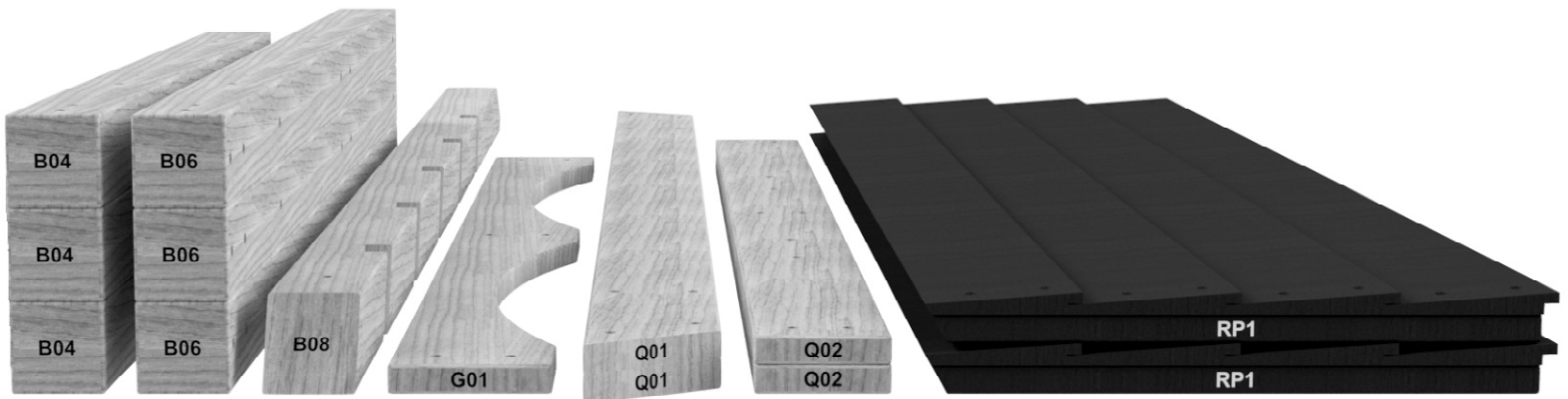

## HARDWARE PARTS:

- We recommend that you have a separate table to organize the hardware.
- Hardware bags are printed with a seven-digit, alpha-numeric part number.
- You can organize your hardware by part number or group by hardware type (i.e. bolts, nuts, etc.).
- During assembly you only need to reference the last four digits of the number.

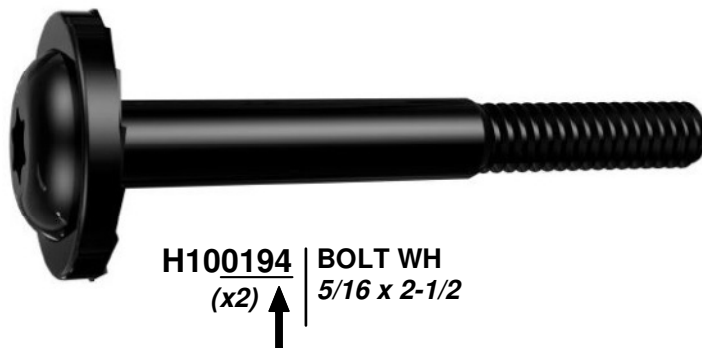

# PRE-ASSEMBLY STEP 2 - TOOLS REQUIRED



*Cordless Drill or  
Electric Drill*



*Drill Attachments:  
Phillips Head*



*1/8", 3/16", 3/8" & 7/16"  
Drill Bits*



*Phillips Screw Driver*



*Open End Wrenches 1/2" & 9/16"*



*3/8" Drive Ratchet, 1/2" &  
9/16" STD Sockets 1/2" & 9/16"  
Deep Sockets*



*Claw Hammer*



*Rubber Mallet - Optional*



*Tape Measure*

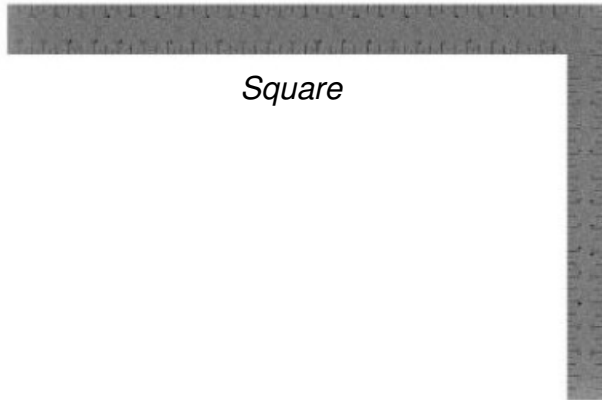

*Square*





*Level 24"*

# PRE-ASSEMBLY STEP 3 - CHOOSE YOUR ASSEMBLY METHOD



There are several types of assembly instructions available to you.

1. *Printed Assembly Manual included with your set*
2. *BILT APP - 3D interactive instructions*
3. *Combination of the Printed Manual and BILT APP (Note: Step numbers can differ between the two methods)*

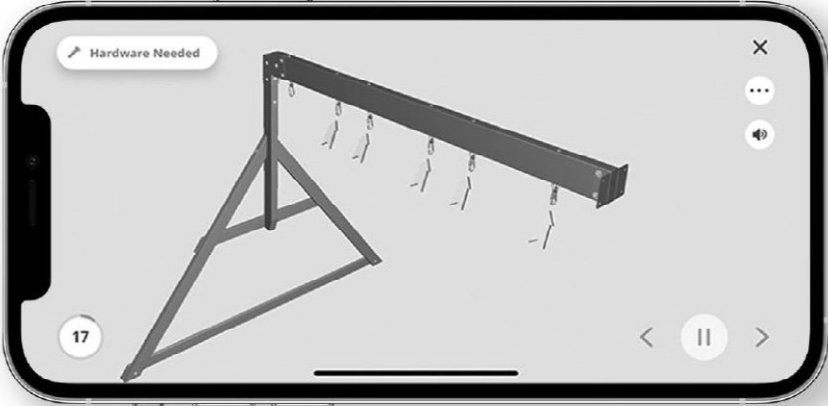

## Scan for easy 3D instructions

Download the BILT app  
before you begin



The image shows a smartphone screen displaying the BILT app interface. The screen features a 3D assembly diagram of a metal frame structure. At the top left of the screen, there is a button labeled "Hardware Needed". In the bottom left corner, the number "17" is displayed. In the bottom right corner, there are navigation icons: a back arrow, a pause button, and a forward arrow. The entire advertisement is enclosed in a grey border.

# STEP 1 - LADDER

QTY	PART NUMBER	DESCRIPTION
8	H100091	SCREW PFH 8x2 1/4



**E74 | LEFT UPRIGHT - W4L16028**  
*(x1) | 1 3/8"x3 3/8"x50 3/4" (36x86x1290)*

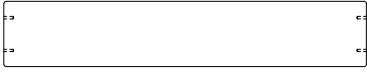

**H07 | LADDER RUNG - W4L16030**  
*(x4) | 15/16"x3 3/8"x18 7/8" (24x86x480)*

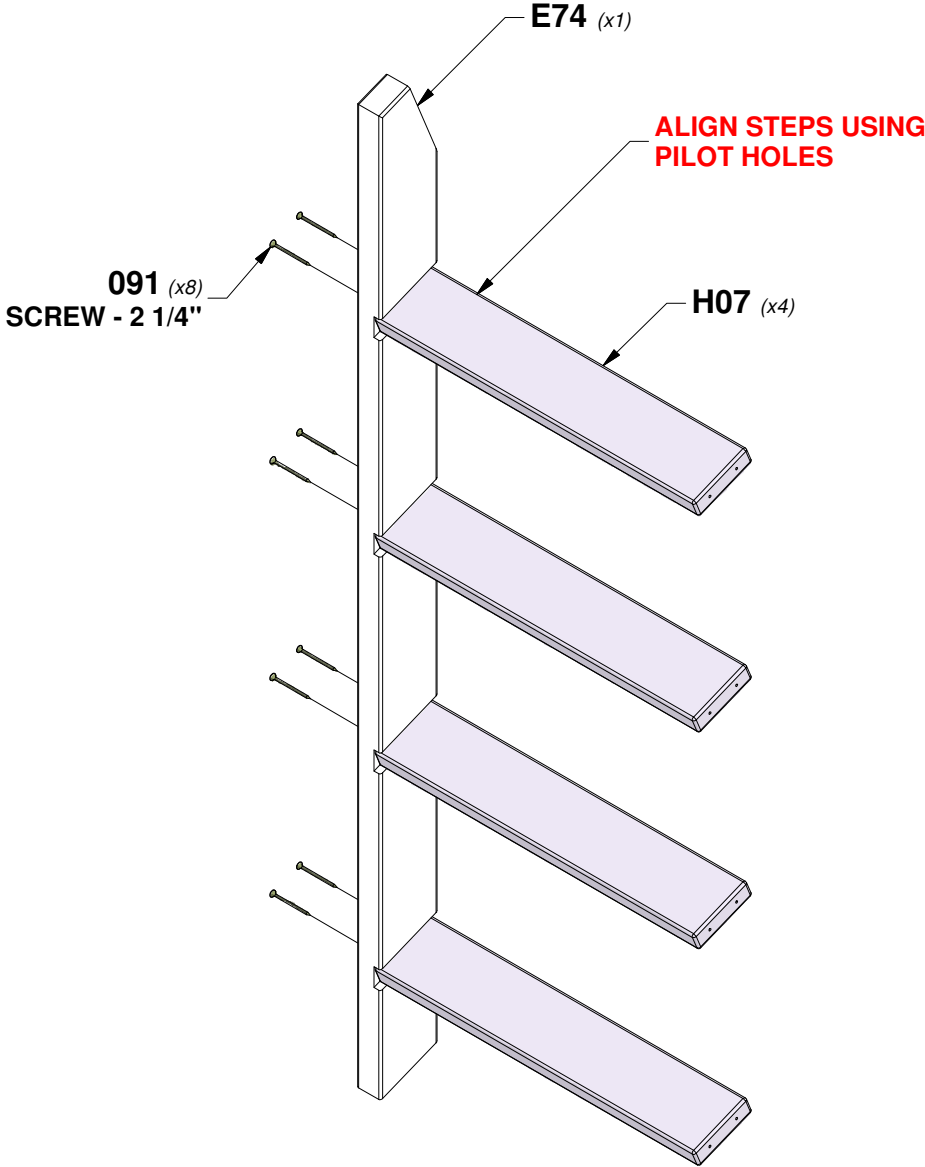

# STEP 2 - LADDER

QTY	PART NUMBER	DESCRIPTION
8	H100091	SCREW PFH 8x2 1/4



**E75** | RIGHT UPRIGHT - W4L16029  
(x1) | 1 3/8"x3 3/8"x50 3/4" (36x86x1290)

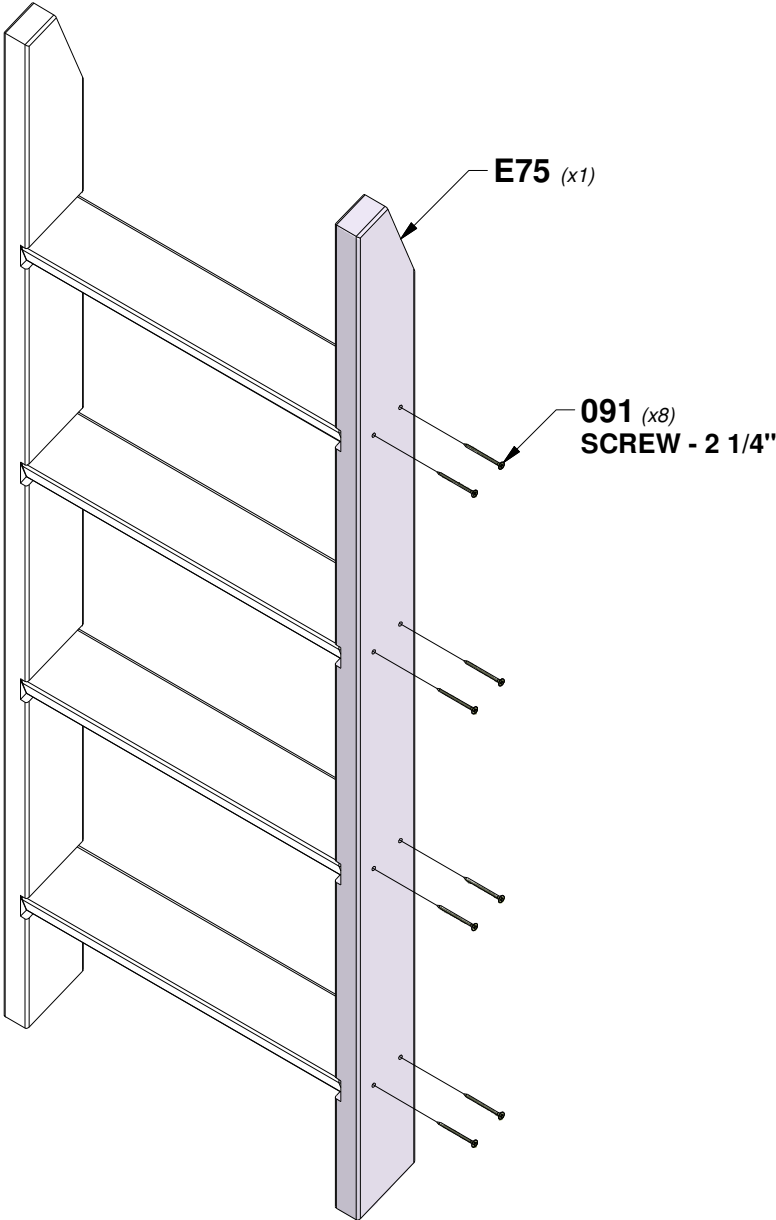

# STEP 3 - LADDER

QTY	PART NUMBER	DESCRIPTION
4	H100091	SCREW PFH 8x2 1/4



**M73** REAR SUPPORT - W4L16070  
(x1) 5/8"x3 3/8"x21" (16x86x532)

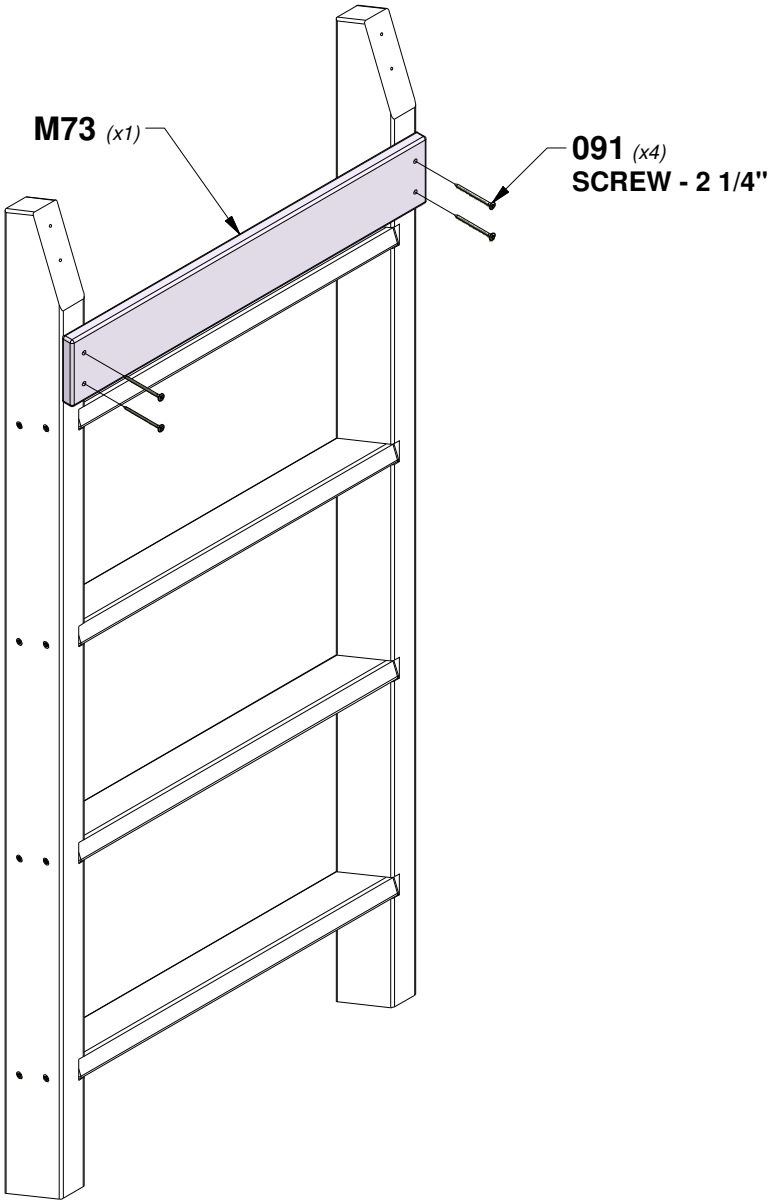

# STEP 4 - LADDER

QTY	PART NUMBER	DESCRIPTION
4	H100091	SCREW PFH 8x2 1/4



**H06** LADDER MOUNT - W4L16088  
(x1) 1"x3 3/8"x21" (24x86x532)

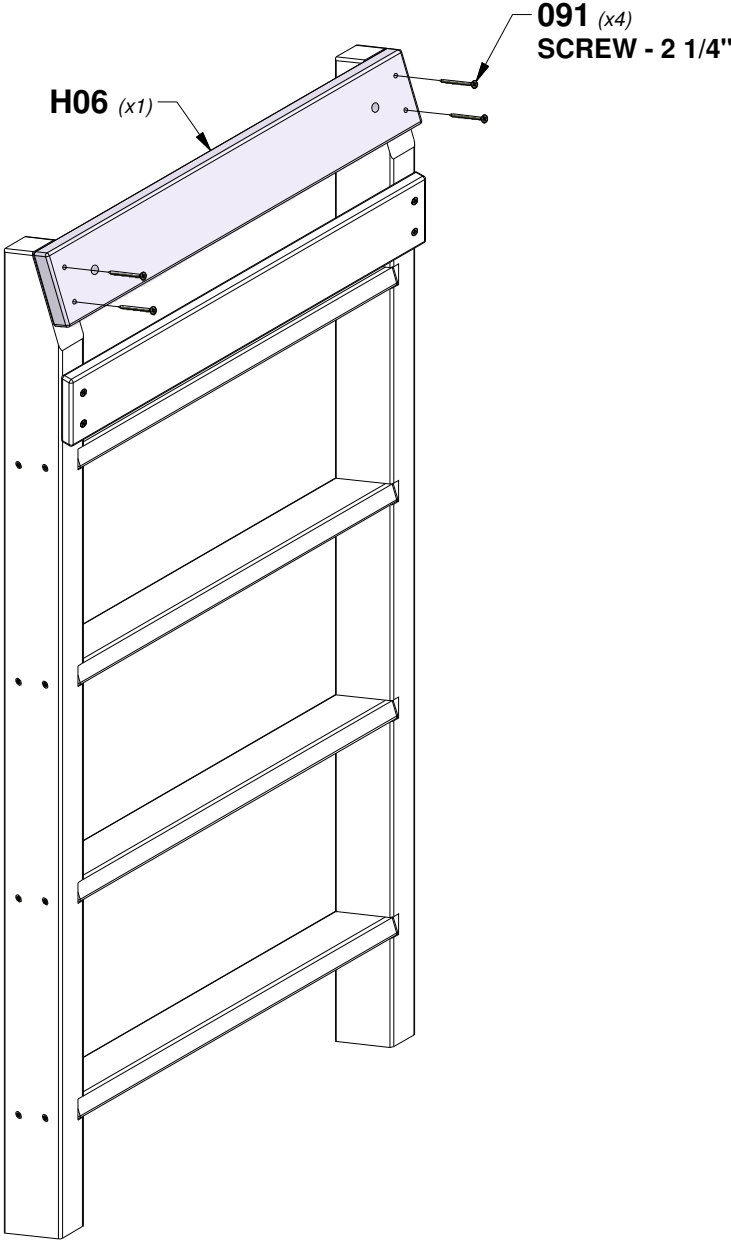

# STEP 1 - ROCK WALL

QTY	PART NUMBER	DESCRIPTION
24	H100063	BOLT PTH 1/4x3/4
24	H100072	T-NUT 1/4
24	H100108	WASHER LOCK INT 8x15

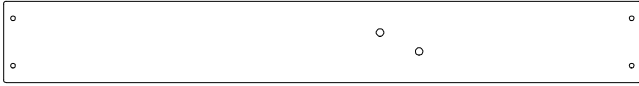

**M75** | ROCK WALL BOARD - W4L16072  
(x4) 5/8"x3 3/8"x26 5/8" (16x86x675)



**M76** | ROCK WALL BOARD - W4L16073  
(x4) 5/8"x3 3/8"x26 5/8" (16x86x675)

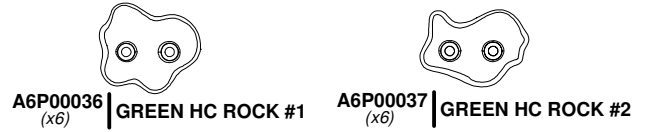

**TIP:**  
INSTALL T-NUTS IN WOOD FIRST

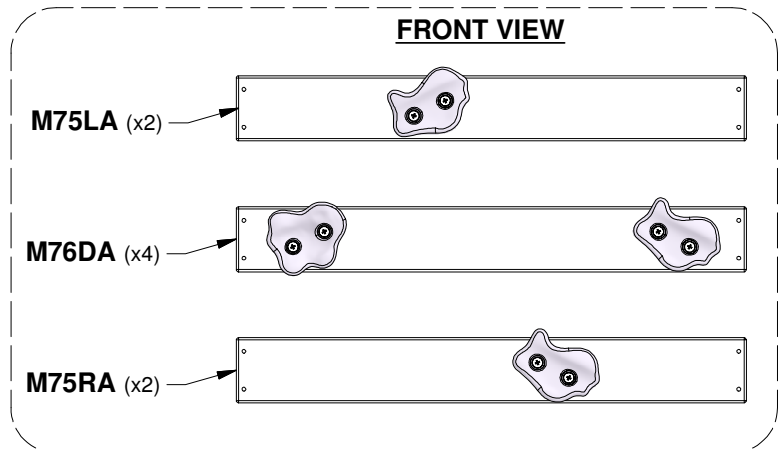
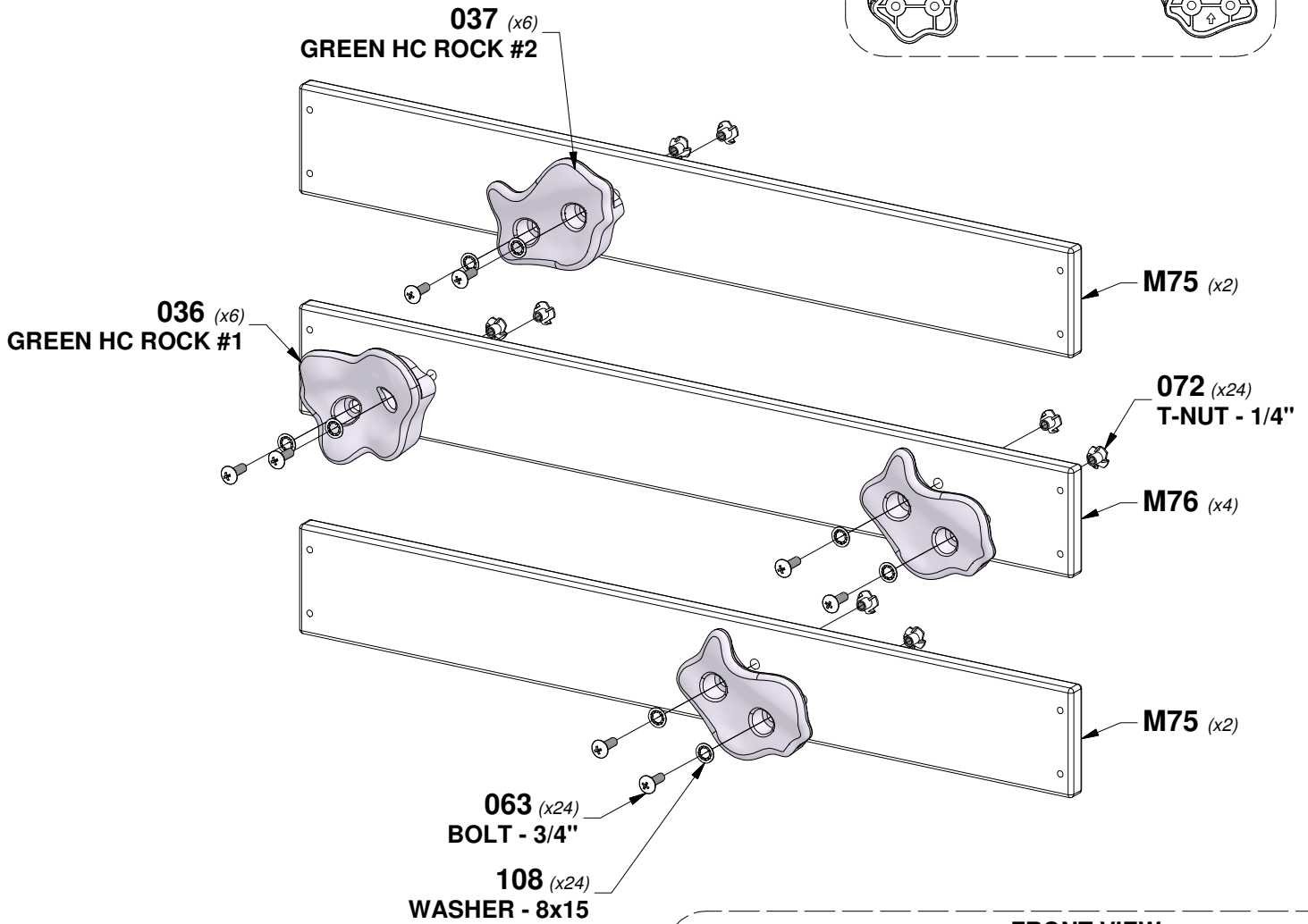
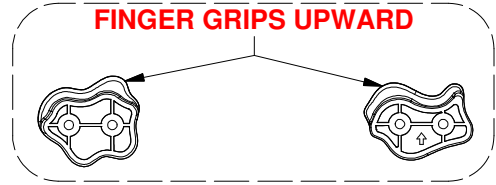

# STEP 2 - ROCK WALL

QTY	PART NUMBER	DESCRIPTION
74	H100086	SCREW PFH 8x1-1/2"

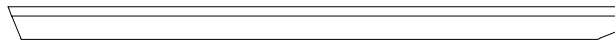
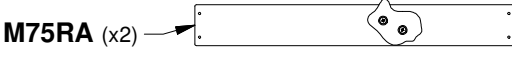
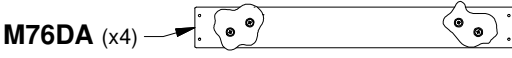

**E72** | LEFT RAIL - W4L16007  
(x1) | 1 3/8"x3 3/8"x64 1/2" (36x86x1640)

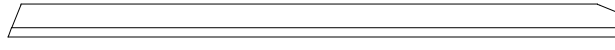

**E73** | RIGHT RAIL - W4L16008  
(x1) | 1 3/8"x3 3/8"x64 1/2" (36x86x1640)

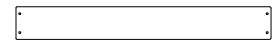

**M74** | ROCK WALL BOARD - W4L16071  
(x10) | 5/8"x3 3/8"x26 5/8" (16x86x675)

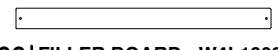

**N06** | FILLER BOARD - W4L16089  
(x1) | 5/8"x2 1/8"x26 5/8" (16x54x675)

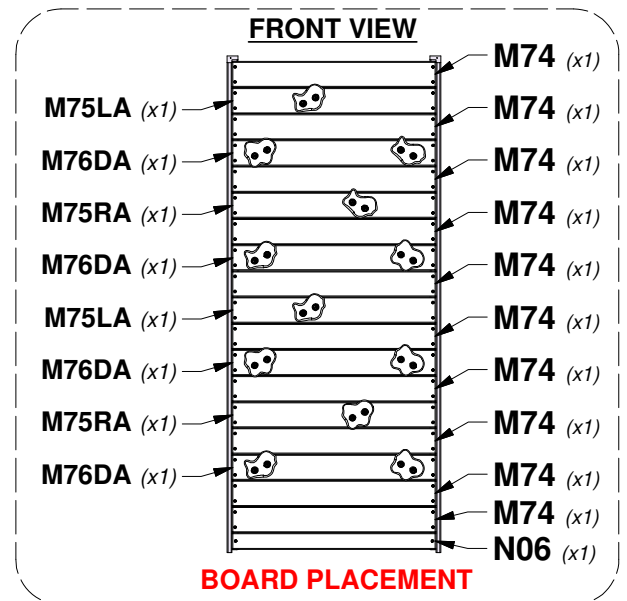
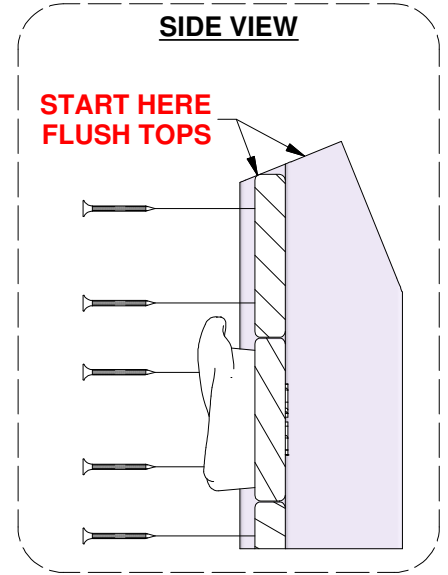
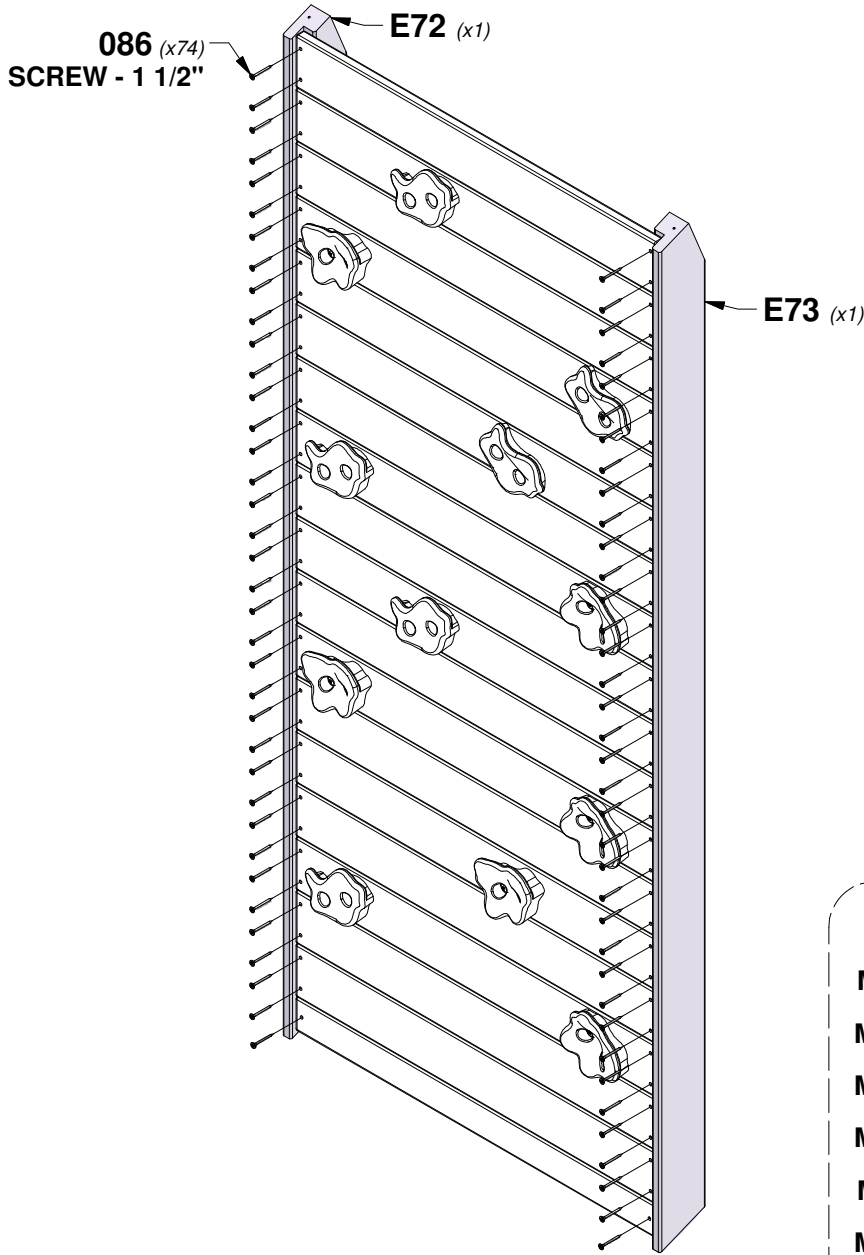

# STEP 3 - ROCK WALL

QTY	PART NUMBER	DESCRIPTION
2	H100086	SCREW PFH 8x1-1/2"



**M108** | TOP BOARD - W4L16046  
(x1) | 5/8"x3 1/4"x27 7/8" (16x82x707)

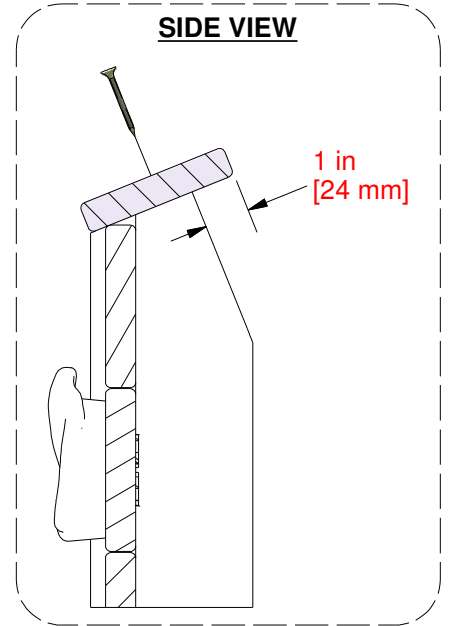
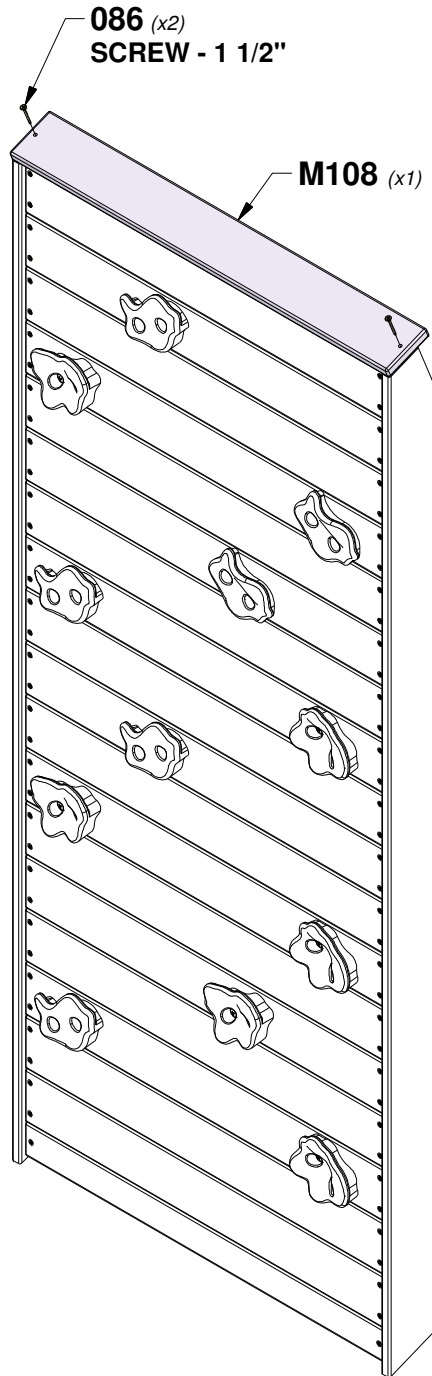

# STEP 4 - ROCK WALL

QTY	PART NUMBER	DESCRIPTION
2	H100074	T-NUT 5/16
4	H100111	SCREW PFH 8x2"

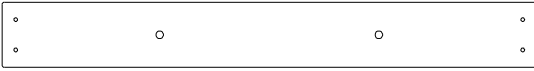

**H10 | ATTACHMENT BOARD - W4L16045**  
 (x1) 1"x3 3/8"x27 7/8" (24x86x707)

**TIP:**  
**INSTALL T-NUTS IN WOOD FIRST**

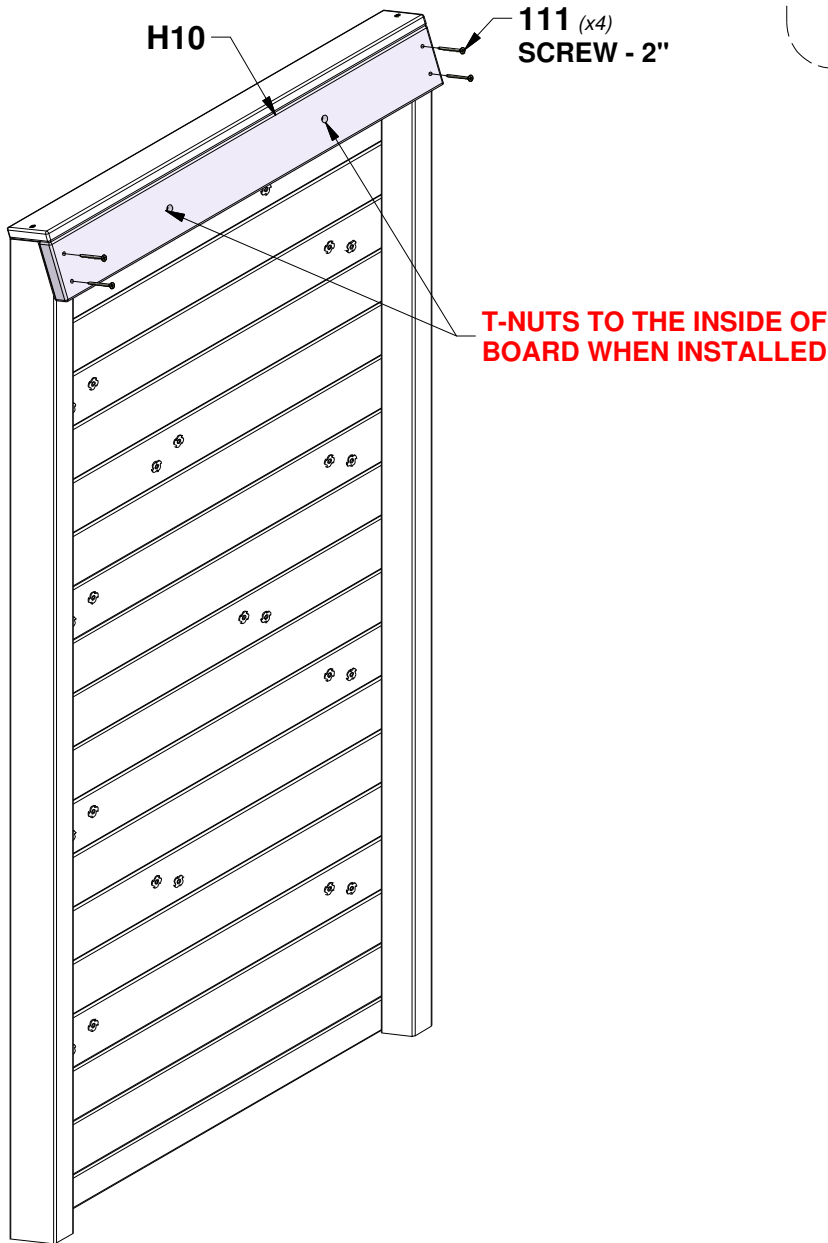
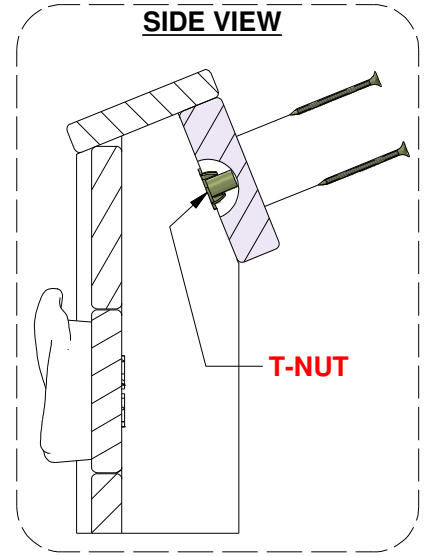
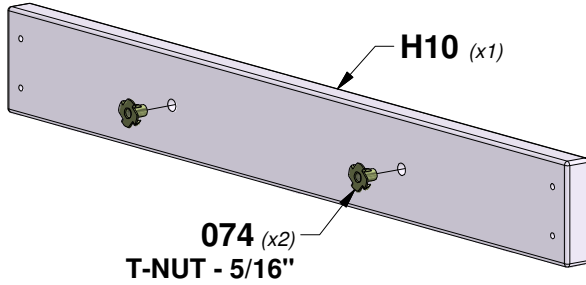

# STEP 1 - SWING BEAM

QTY	PART NUMBER	DESCRIPTION
3	H100005	NUT BARREL WH 5/16x7/8
3	H100016	BOLT WH 5/16x3
2	H100054	BOLT HEX 5/16x4 1/4
4	H100105	WASHER FLAT 8x27
2	H100110	NUT LOCK 5/16

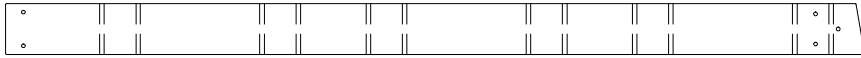

**A50 | SWING BEAM - W4L15998**  
(x1) | 3 3/8"x5 1/4"x89 1/2" (86x134x2274)

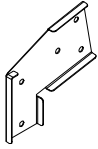

**A100325 | SWING BEAM EXTENSION BRACKET-LEFT**  
(x1)

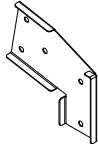

**A100326 | SWING BEAM EXTENSION BRACKET-RIGHT**  
(x1)



**A100140 | L BRACKET**  
(x2) | 66x66x127

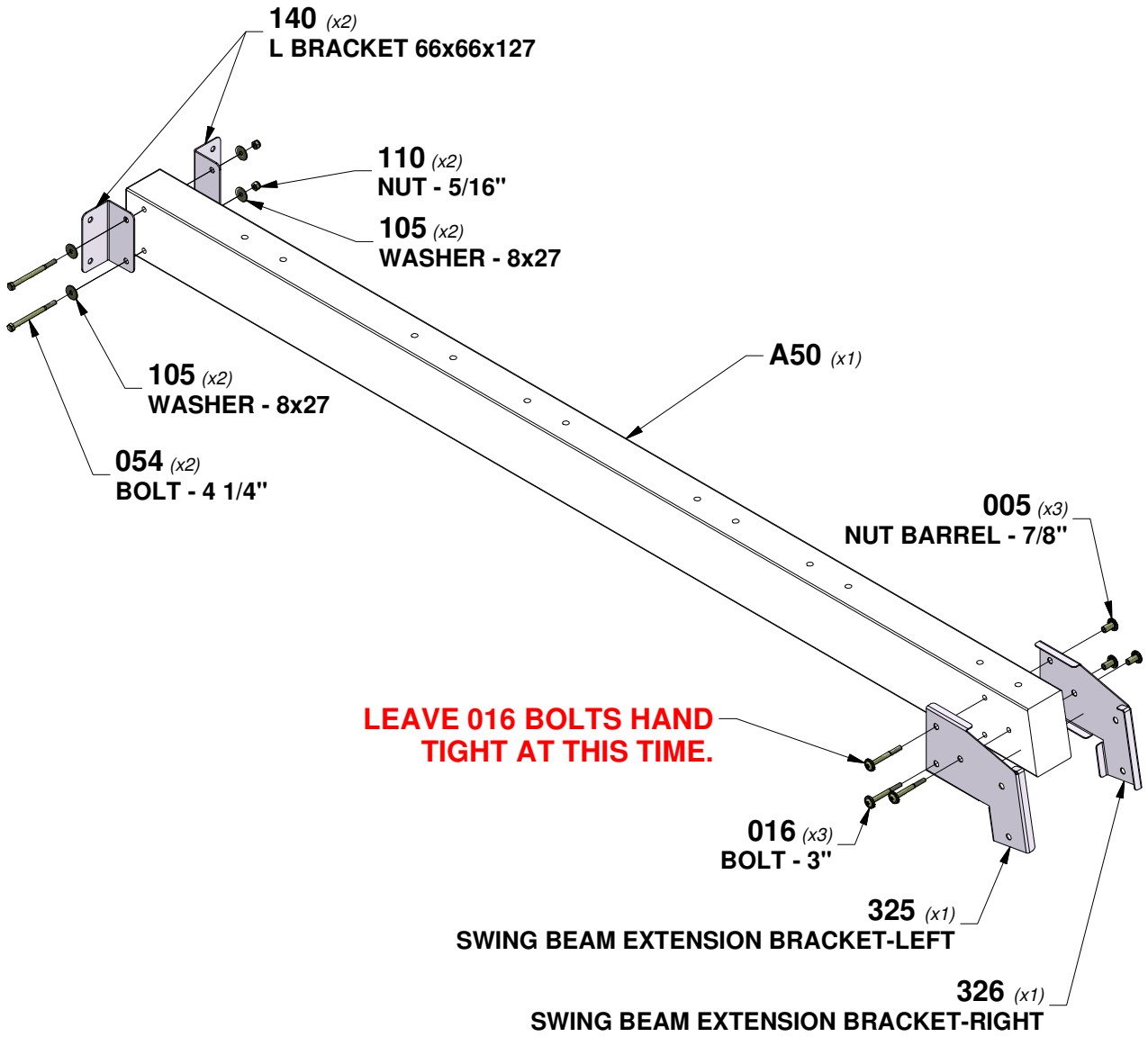

# STEP 2 - SWING BEAM

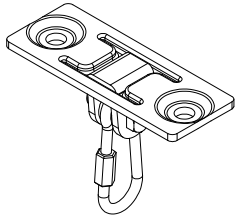

**A4M00505** | SWING HANGER  
(x6)

QTY	PART NUMBER	DESCRIPTION
12	H100073	T-NUT 3/8
12	H100102	WASHER FLAT 11x25
12	H100107	WASHER LOCK INT 10x18
12	H100654	BOLT HEX 3/8x5-1/2

**TIP:**  
**INSTALL T-NUTS IN WOOD FIRST**

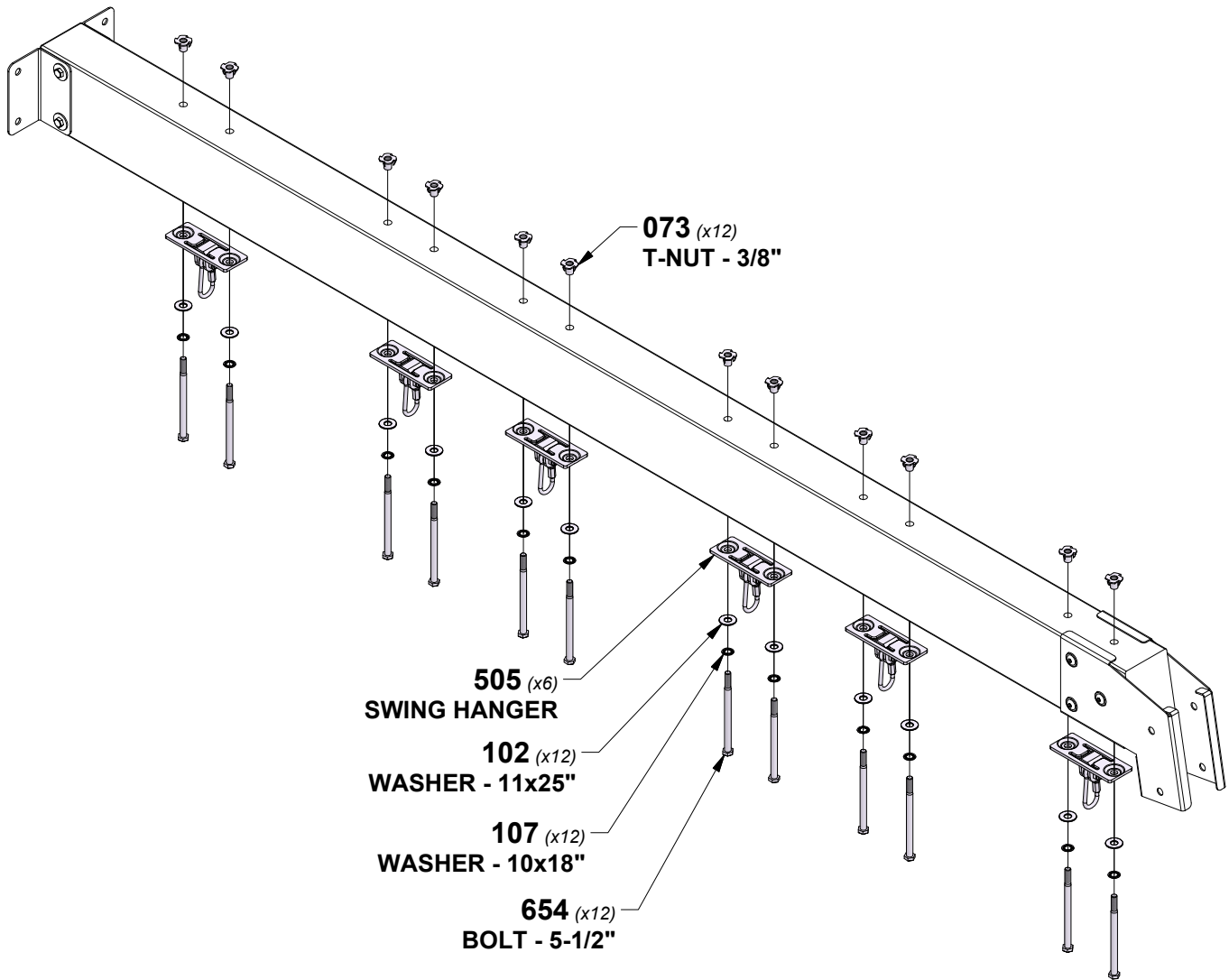

# STEP 3 - SWING BEAM

QTY	PART NUMBER	DESCRIPTION
4	H100124	SCREW PFH 8x1/2



A100164 (x1) BYD ID TAG  
(LARGE) AGES  
3-10

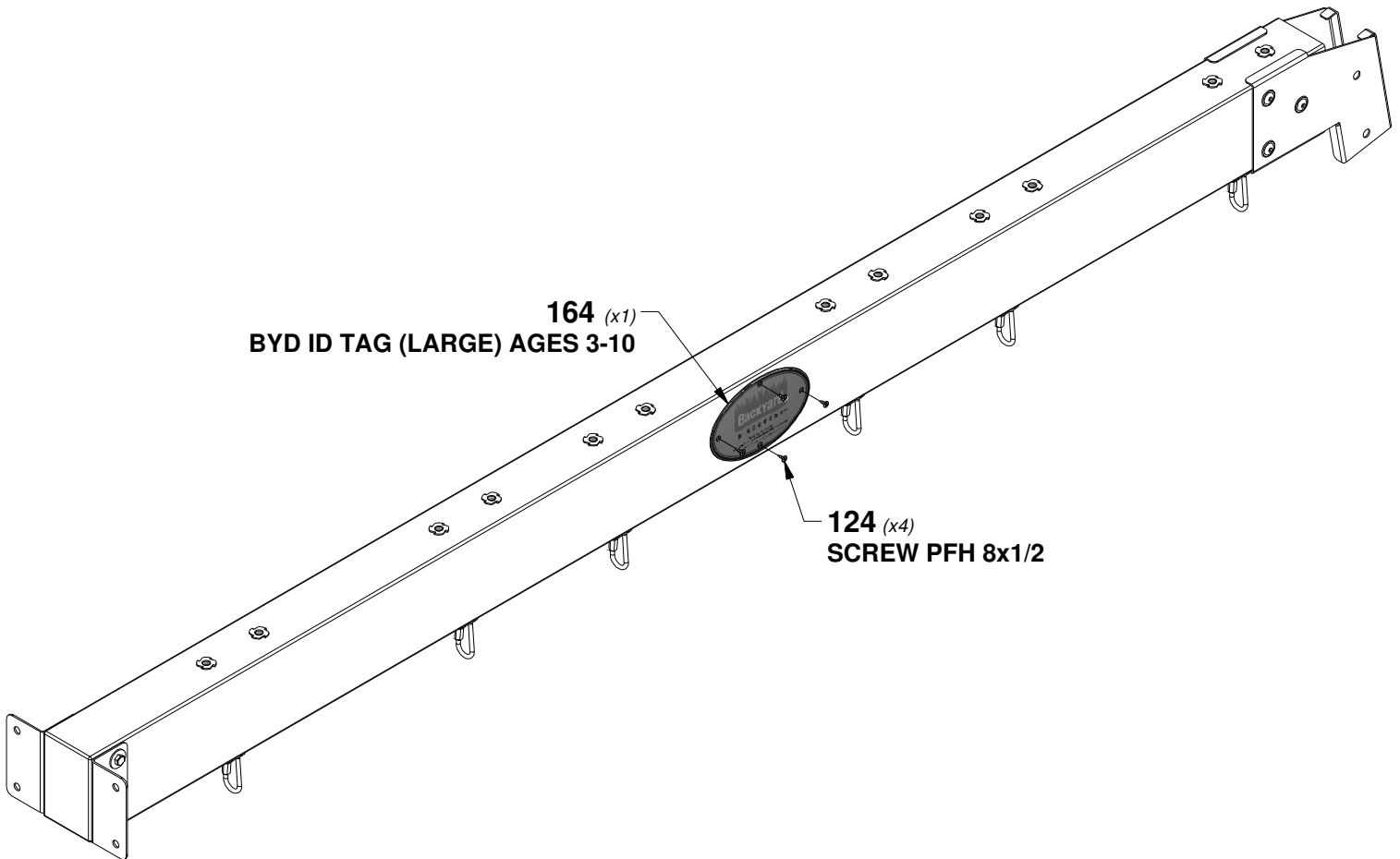

164 (x1)  
BYD ID TAG (LARGE) AGES 3-10

124 (x4)  
SCREW PFH 8x1/2

# STEP 4 - SWING BEAM

QTY	PART NUMBER	DESCRIPTION
4	H100009	BOLT WH 5/16x1 1/4
2	H100018	BOLT WH 5/16x3 1/2
6	H100074	T-NUT 5/16



**SP50** | SWING BEAM SUPPORT - W4L16085  
(x1) | 3 3/8"x3 3/8"x49 3/8" (86x86x1254)

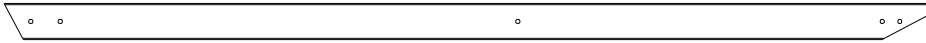

**E51** | ANGLE BRACE - W4L16004  
(x2) | 1 7/16"x3 3/8"x87 3/16" (36x86x2214)

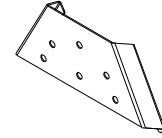

**A4M01169** | A-FRAME BRACKET  
(x1)

**TIP:**  
INSTALL T-NUTS IN WOOD FIRST

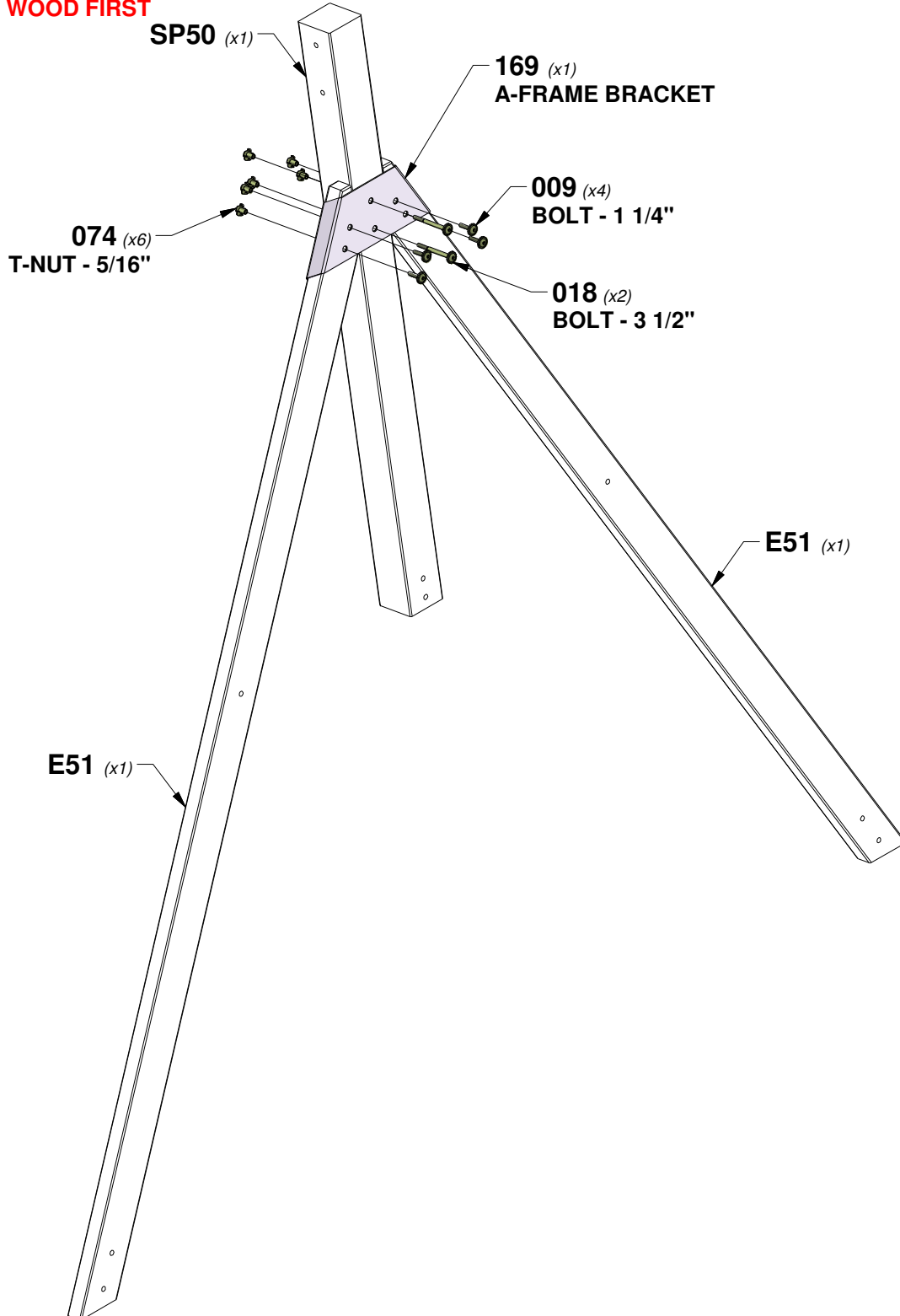

# STEP 5 - SWING BEAM

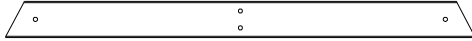

**E50** | END SUPPORT - W4L16003  
(x1) | 1 3/8"x3 3/8"x44 1/8" (36x86x1120)

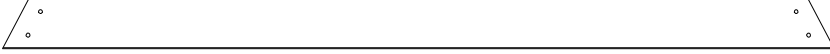

**G14** | GROUND BOARD - W4L16019  
(x1) | 15/16"x5 1/4"x86 11/16" (24x134x2202)

QTY	PART NUMBER	DESCRIPTION
4	H100013	BOLT WH 5/16x2 1/4
2	H100015	BOLT WH 5/16x2 3/4
8	H100030	WASHER LOCK EXT 8x19
8	H100074	T-NUT 5/16
2	H100505	BOLT WH 5/16x4 3/4

**TIP:**  
INSTALL T-NUTS IN WOOD FIRST

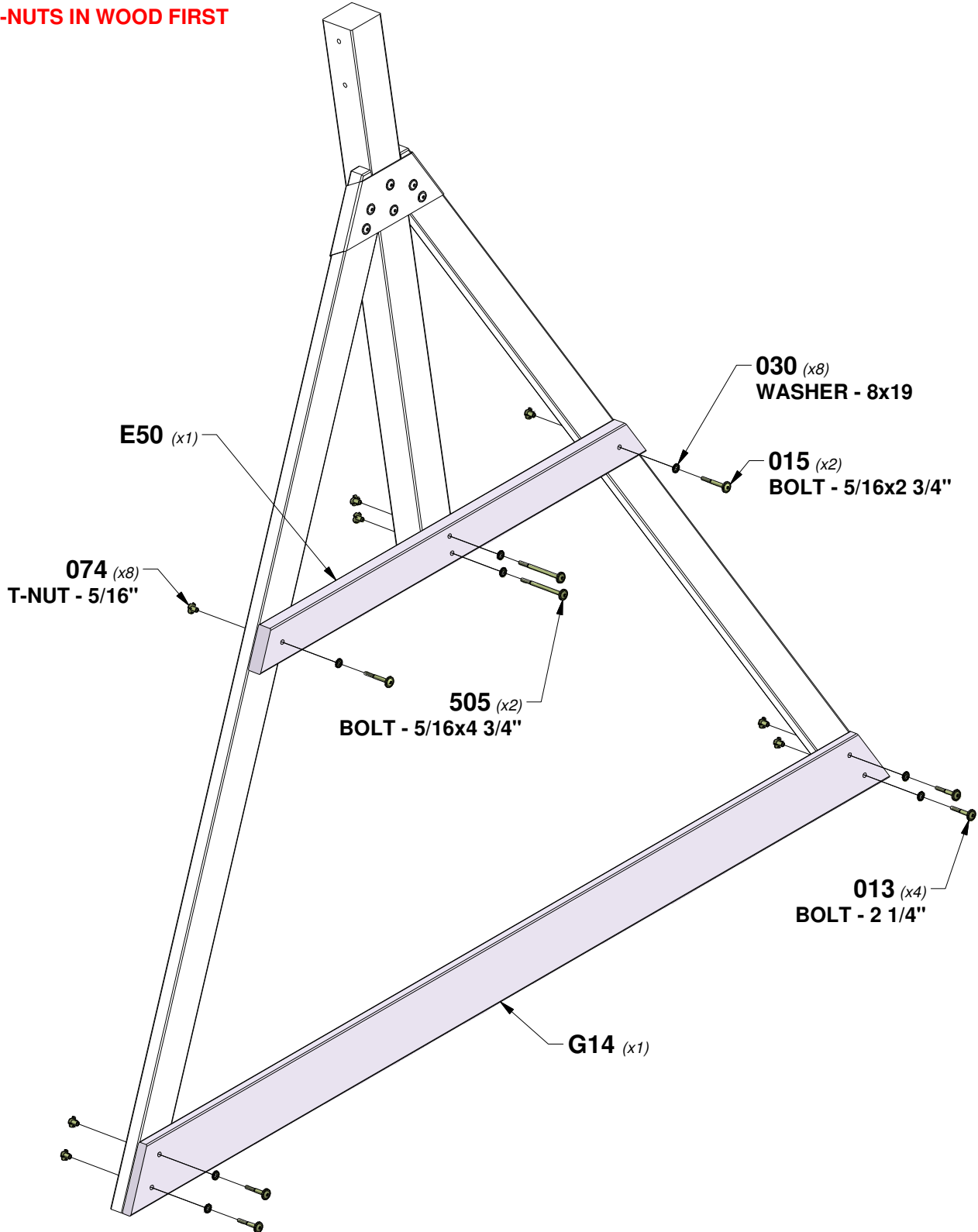

# STEP 6 - SWING BEAM

QTY	PART NUMBER	DESCRIPTION
2	H100005	NUT BARREL WH 5/16x7/8
2	H100016	BOLT WH 5/16x3

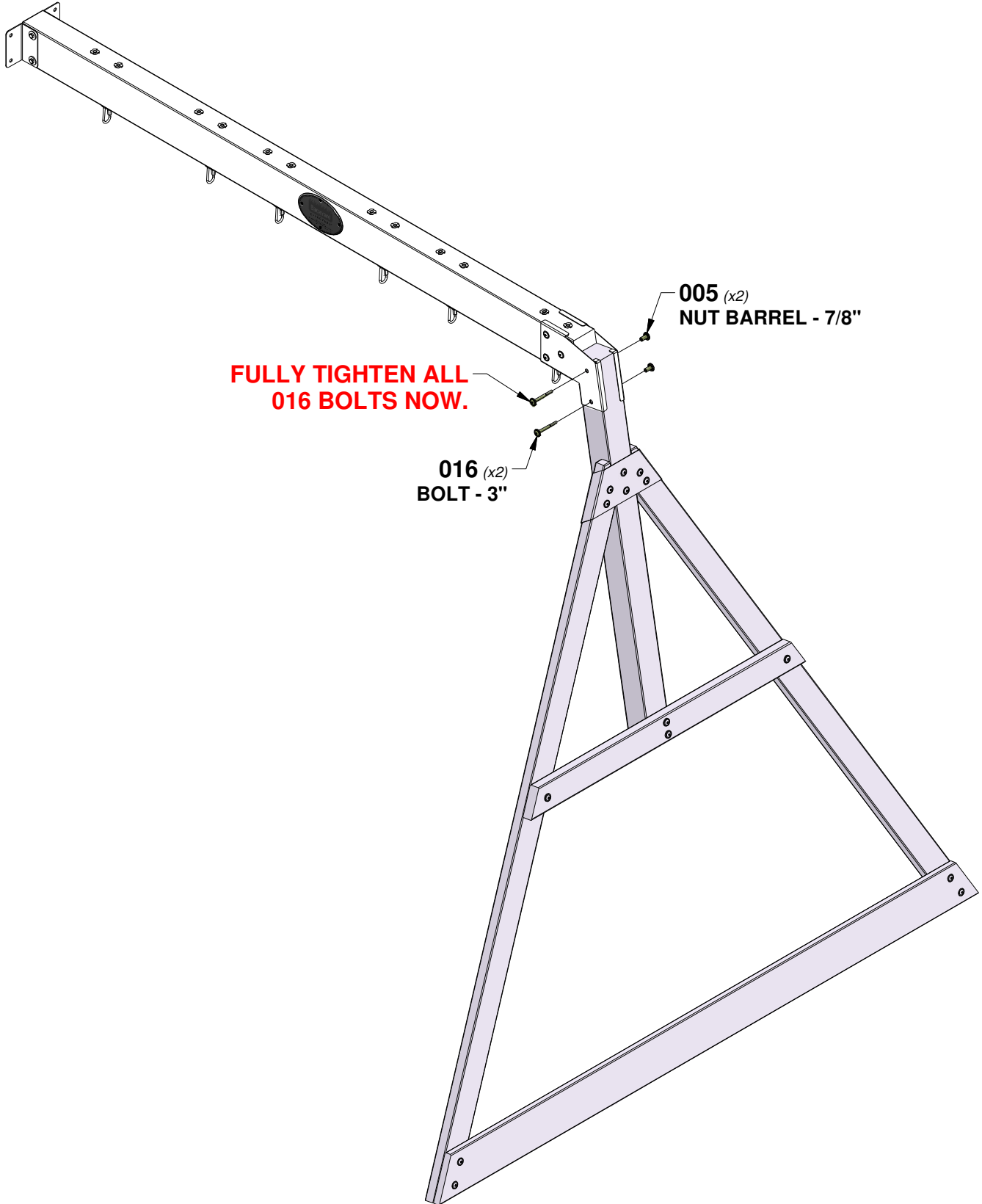

# STEP 1 - FORT ASSEMBLY

QTY	PART NUMBER	DESCRIPTION
2	H100013	BOLT WH 5/16x2 1/4
12	H100028	LAG SCREW WH 5/16x2 1/2
14	H100030	WASHER LOCK EXT 8x19
2	H100074	T-NUT 5/16
2	H100138	WASHER LOCK EXT 6x15
2	H100146	LAG SCREW WH 1/4x2

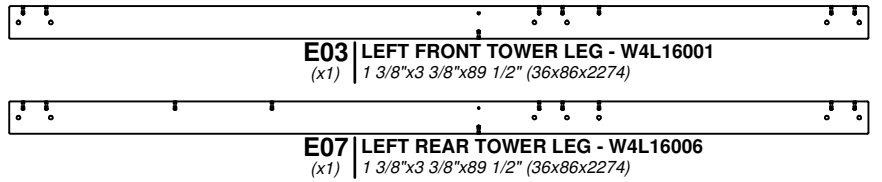
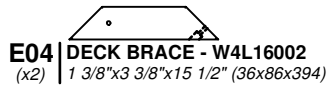
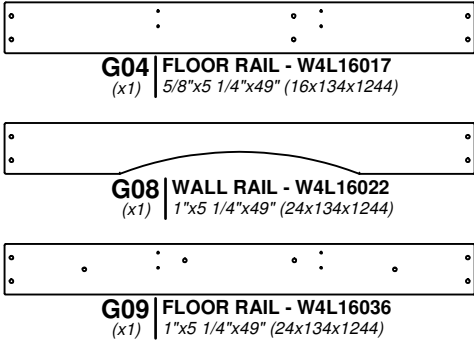

**TIP:**  
INSTALL T-NUTS IN WOOD FIRST

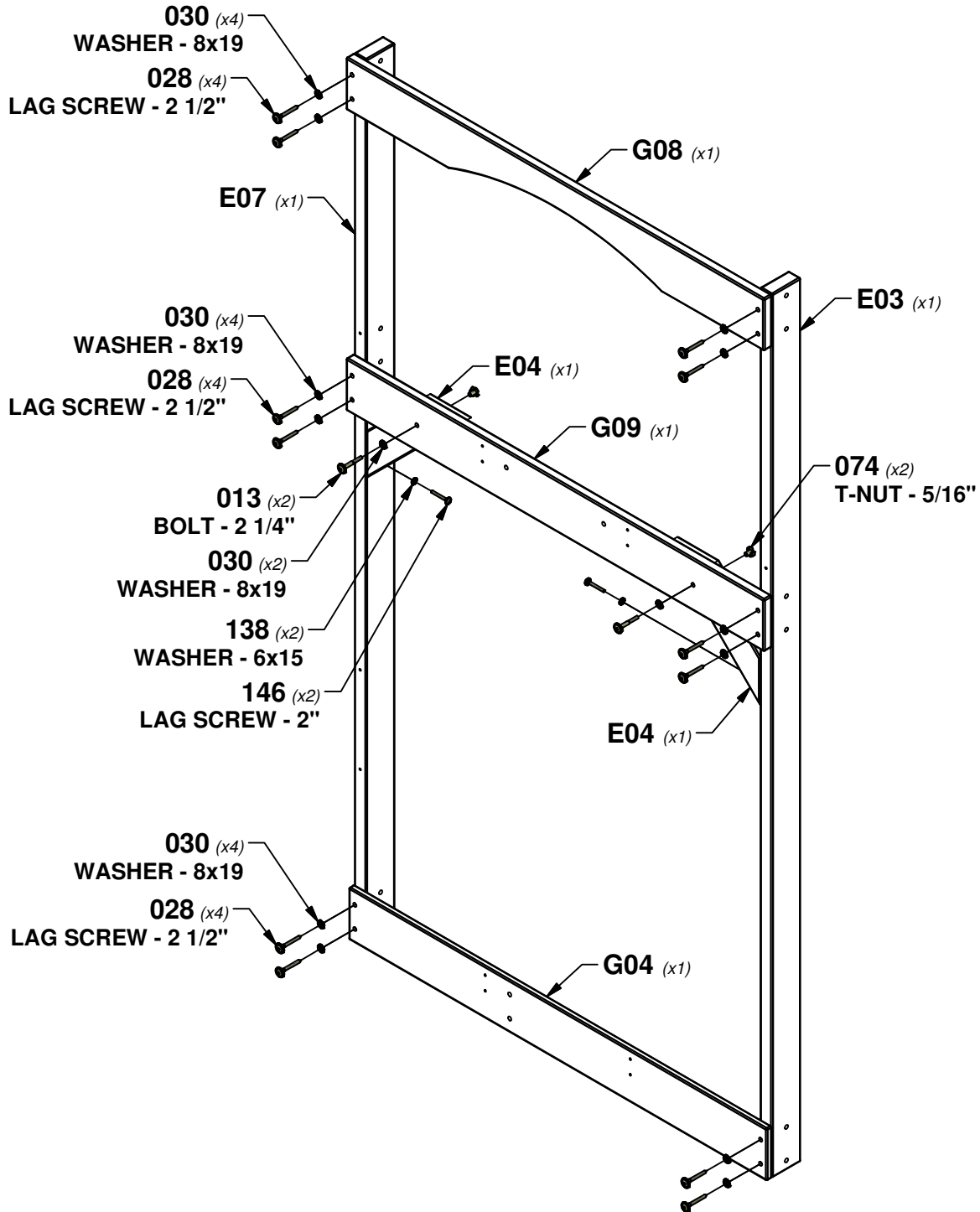

# STEP 2 - FORT ASSEMBLY

QTY	PART NUMBER	DESCRIPTION
20	H100028	LAG SCREW WH 5/16x2 1/2
20	H100030	WASHER LOCK EXT 8x19

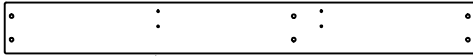

**G04** FLOOR RAIL - W4L16017  
(x1) 5/8"x5 1/4"x49" (16x134x1244)

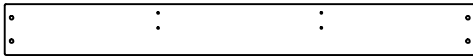

**G07** FLOOR RAIL - W4L16021  
(x2) 1"x5 1/4"x49" (24x134x1244)

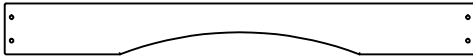

**G08** WALL RAIL - W4L16022  
(x1) 1"x5 1/4"x49" (24x134x1244)

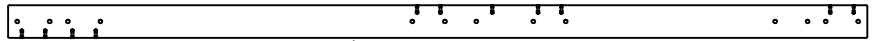

**E02** CENTER FRONT TOWER LEG - W4L16000  
(x1) 1 3/8"x3 3/8"x89 1/2" (36x86x2274)

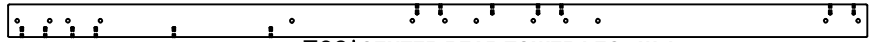

**E06** CENTER REAR TOWER LEG - W4L16005  
(x1) 1 3/8"x3 3/8"x89 1/2" (36x86x2274)

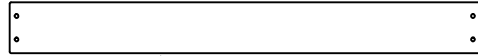

**K02** BASE/SAND BOX BOARD - W4L16035  
(x1) 5/8"x5 1/4"x49" (16x134x1244)

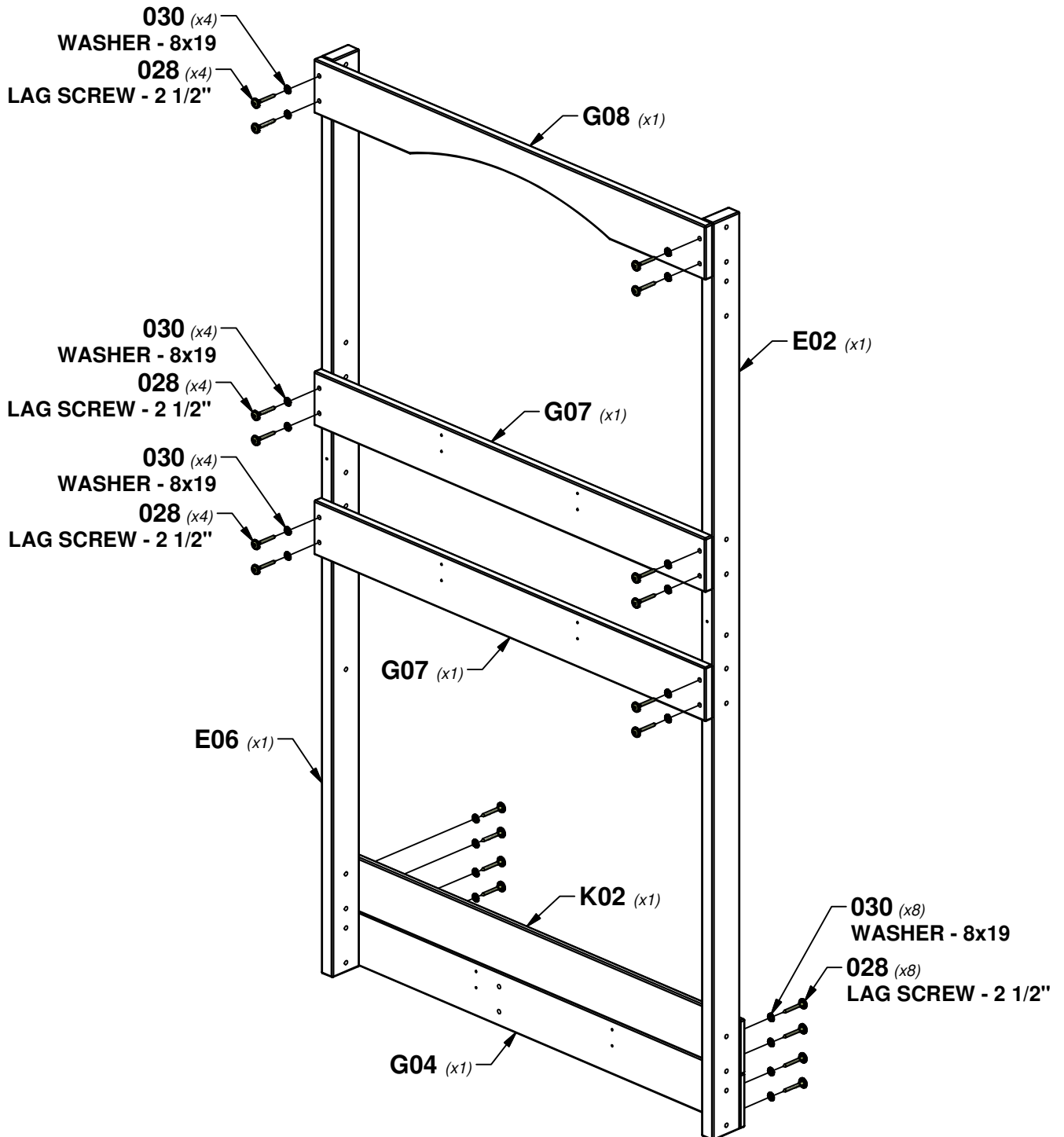

# STEP 3 - FORT ASSEMBLY

QTY	PART NUMBER	DESCRIPTION
2	H100013	BOLT WH 5/16x2 1/4
2	H100027	LAG SCREW WH 5/16x2
12	H100028	LAG SCREW WH 5/16x2 1/2
20	H100030	WASHER LOCK EXT 8x19
10	H100074	T-NUT 5/16
2	H100138	WASHER LOCK EXT 6x15
2	H100146	LAG SCREW WH 1/4x2
4	H100166	BOLT WH 5/16x4 1/4

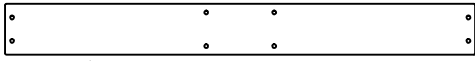

**G05** | WALL RAIL/SWING MOUNT - W4L16018  
(x1) | 1"x5 1/4"x49" (24x134x1244)

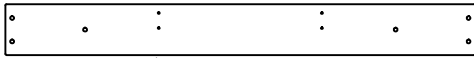

**G06** | FLOOR RAIL - W4L16020  
(x1) | 1"x5 1/4"x49" (24x134x1244)

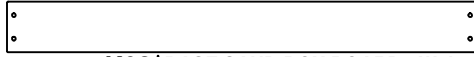

**K02** | BASE/SAND BOX BOARD - W4L16035  
(x2) | 5/8"x5 1/4"x49" (16x134x1244)

**E04** | DECK BRACE - W4L16002  
(x2) | 1 3/8"x3 3/8"x15 1/2" (36x86x394)

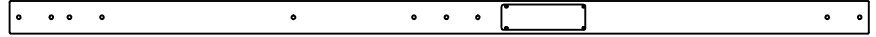

**E05** | RIGHT REAR TOWER LEG - W2A03283  
(x1) | 1 3/8"x3 3/8"x89 1/2" (36x86x2274)



**E01** | RIGHT FRONT TOWER LEG - W4L15999  
(x1) | 1 3/8"x3 3/8"x89 1/2" (36x86x2274)

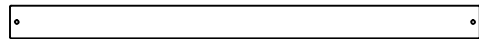

**M05** | WALL RAIL - W4L16066  
(x1) | 5/8"x3 3/8"x49" (16x86x1244)

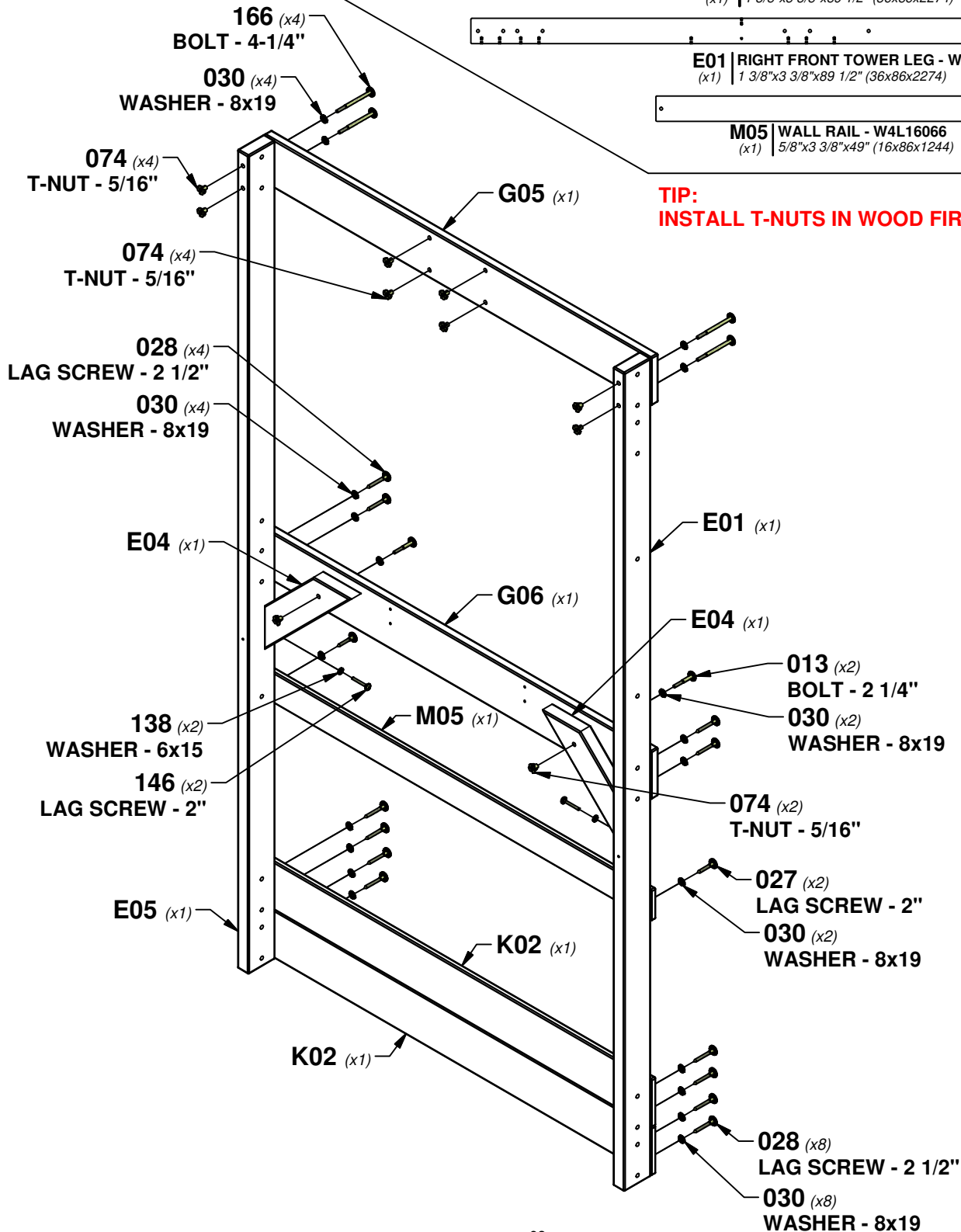

# STEP 4 - FORT ASSEMBLY

QTY	PART NUMBER	DESCRIPTION
12	H100012	BOLT WH 5/16x2
8	H100016	BOLT WH 5/16x3
20	H100030	WASHER LOCK EXT 8x19
20	H100074	T-NUT 5/16

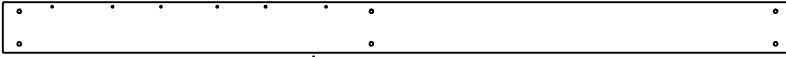

**G01** | BASE BOARD - W4L16009  
(x2) | 5/8"x5 1/4"x82 1/4" (16x134x2088)

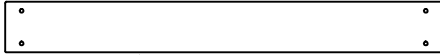

**K03** | GROUND BOARD - W4L16038  
(x2) | 5/8"x5 1/4"x45 1/2" (16x134x1156)



**H05** | BOTTOM FLOOR BOARD SUPPORT - W4L16024  
(x4) | 1"x3 3/8"x5 1/4" (24x86x134)

**TIP:**  
**INSTALL T-NUTS IN WOOD FIRST**

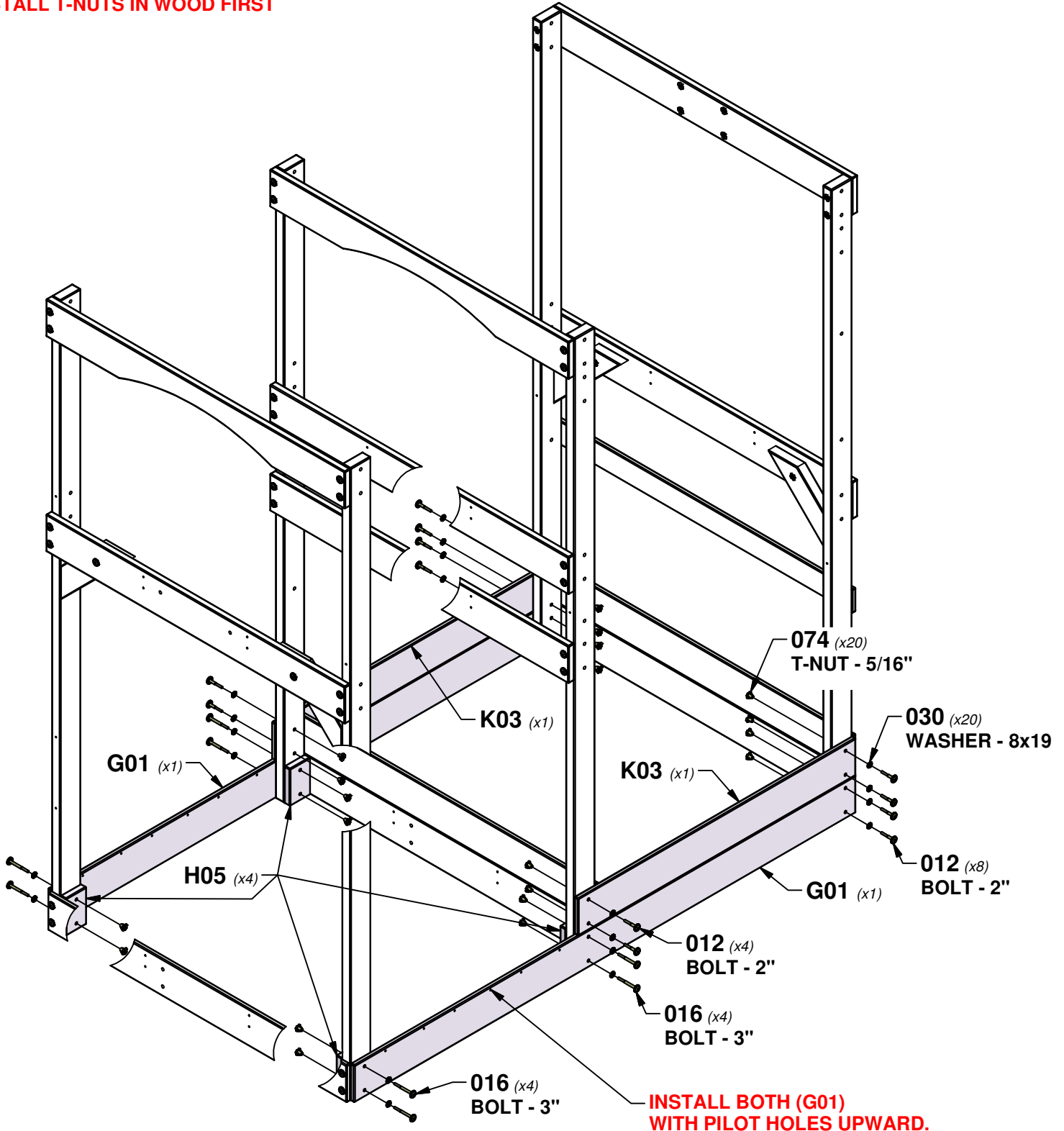

# STEP 5 - FORT ASSEMBLY

QTY	PART NUMBER	DESCRIPTION
4	H100013	BOLT WH 5/16x2 1/4
12	H100017	BOLT WH 5/16x3 1/4
16	H100030	WASHER LOCK EXT 8x19
16	H100074	T-NUT 5/16

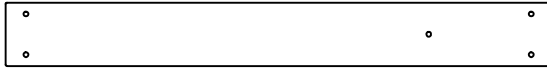

**G10** | FLOOR RAIL - W4L16010  
(x1) | 1"x5 1/4"x45 1/2" (24x134x1156)

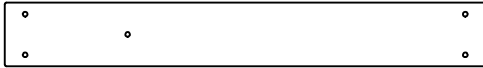

**G12** | FLOOR RAIL - W4L16012  
(x2) | 1"x5 1/4"x40 1/8" (24x134x1018)



**H05** | BOTTOM FLOOR BOARD SUPPORT - W4L16024  
(x6) | 1"x3 3/8"x5 1/4" (24x86x134)

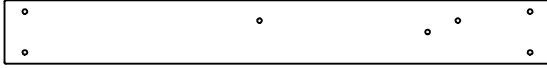

**G15** | FLOOR RAIL - W4L16014  
(x1) | 1"x5 1/4"x45 1/2" (24x134x1156)

**TIP:**  
**INSTALL T-NUTS IN WOOD FIRST**

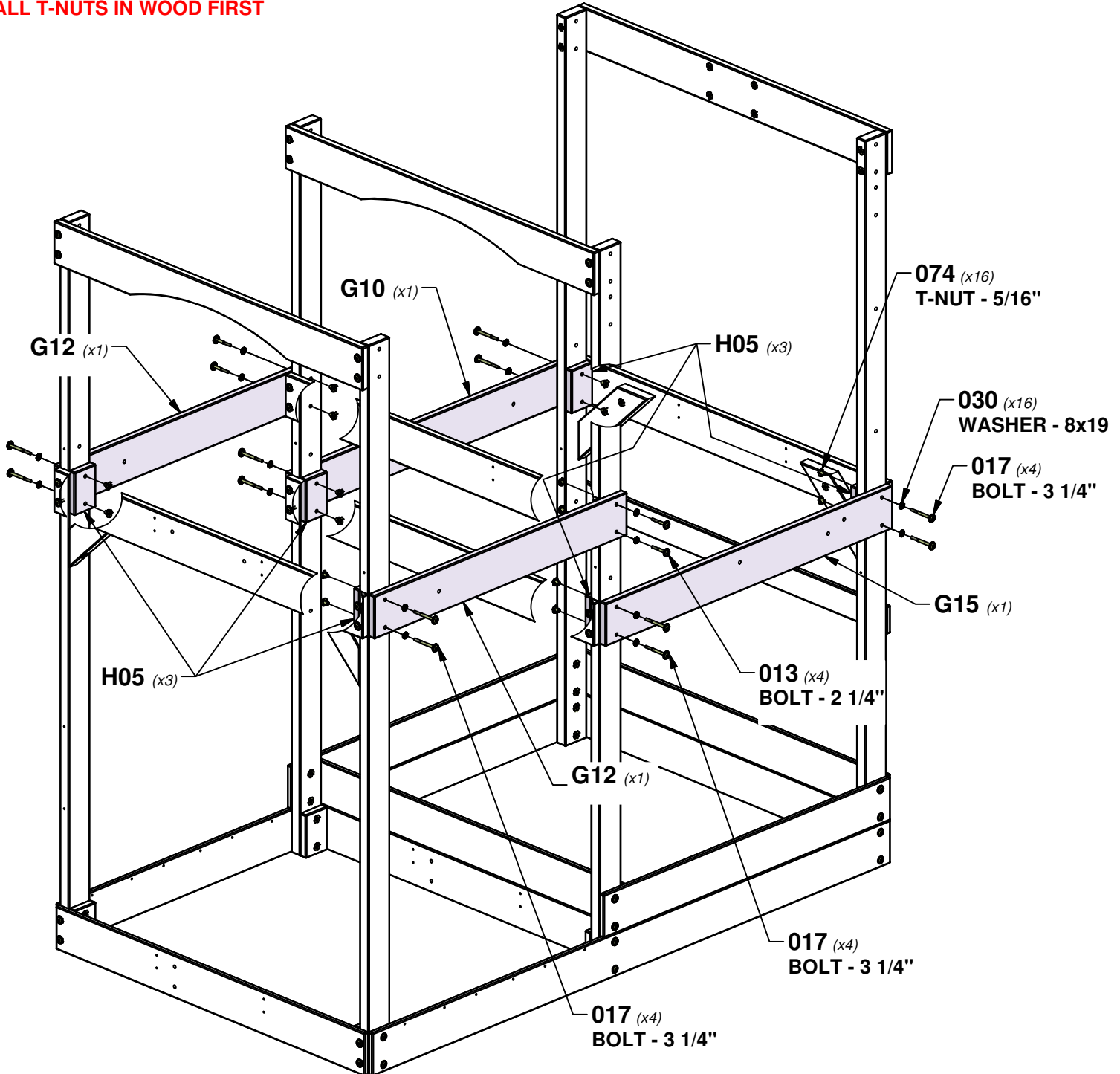

# STEP 6 - FORT ASSEMBLY

QTY	PART NUMBER	DESCRIPTION
12	H100013	BOLT WH 5/16x2 1/4
16	H100030	WASHER LOCK EXT 8x19
16	H100074	T-NUT 5/16
4	H100012	BOLT WH 5/16x2

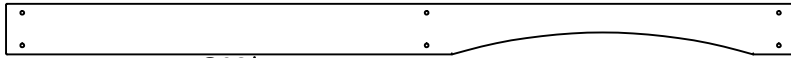

**G02** | WALL RAIL - W4L16015  
(x1) | 1"x5 1/4"x82 1/4" (24x134x2088)

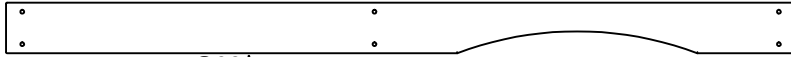

**G03** | WALL RAIL - W4L16016  
(x1) | 1"x5 1/4"x82 1/4" (24x134x2088)

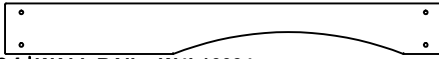

**K01** | WALL RAIL - W4L16034  
(x1) | 5/8"x5 1/4"x45 1/2" (16x134x1156)

**TIP:**  
INSTALL T-NUTS IN WOOD FIRST

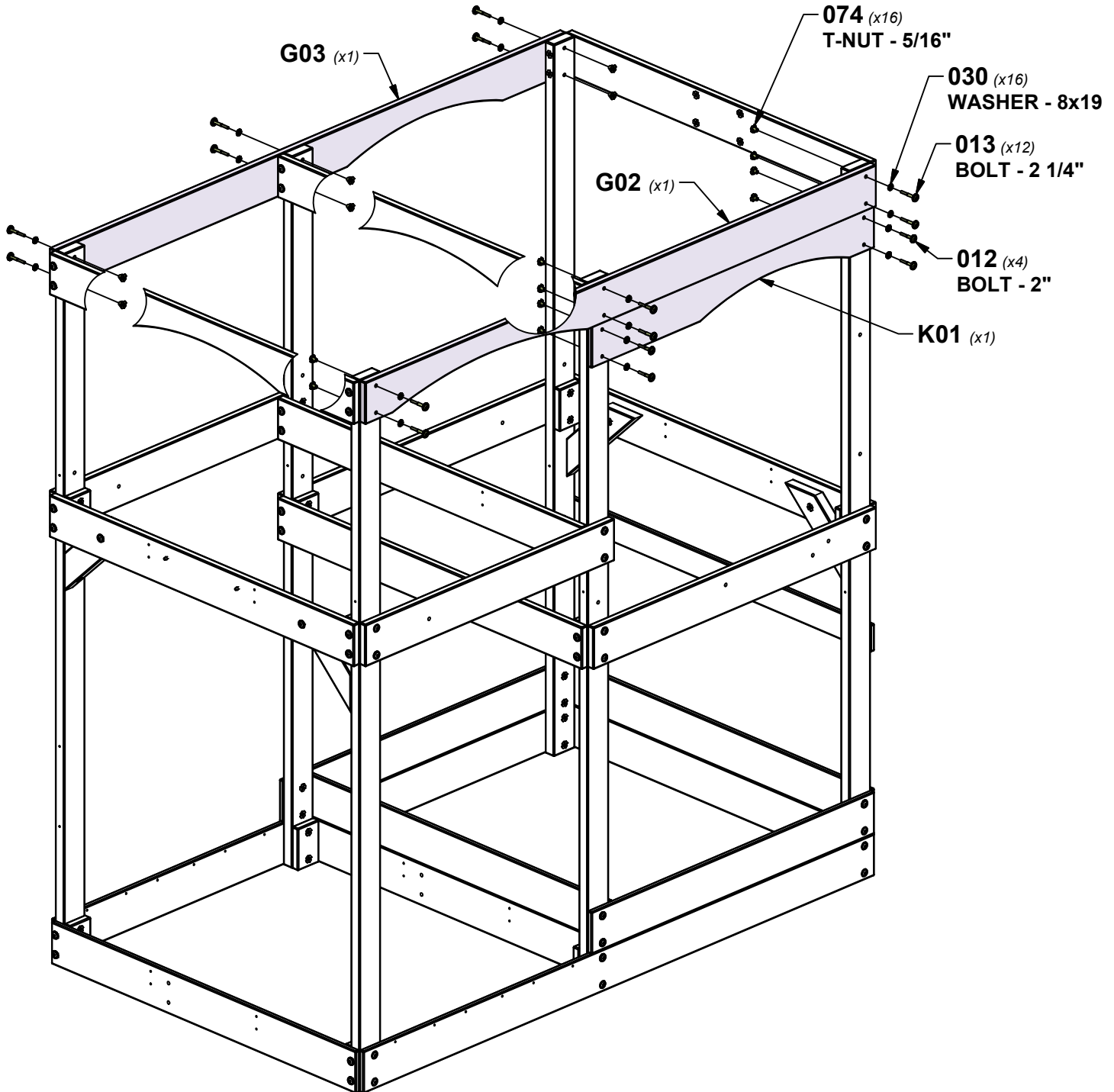

# STEP 7 - FORT ASSEMBLY

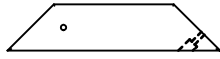

**E04** | DECK BRACE - W4L16002  
(x4) | 1 3/8"x3 3/8"x15 1/2" (36x86x394)

QTY	PART NUMBER	DESCRIPTION
4	H100013	BOLT WH 5/16x2 1/4
4	H100030	WASHER LOCK EXT 8x19
4	H100074	T-NUT 5/16
4	H100138	WASHER LOCK EXT 6x15
4	H100146	LAG SCREW WH 1/4x2

**TIP:**  
INSTALL T-NUTS IN WOOD FIRST

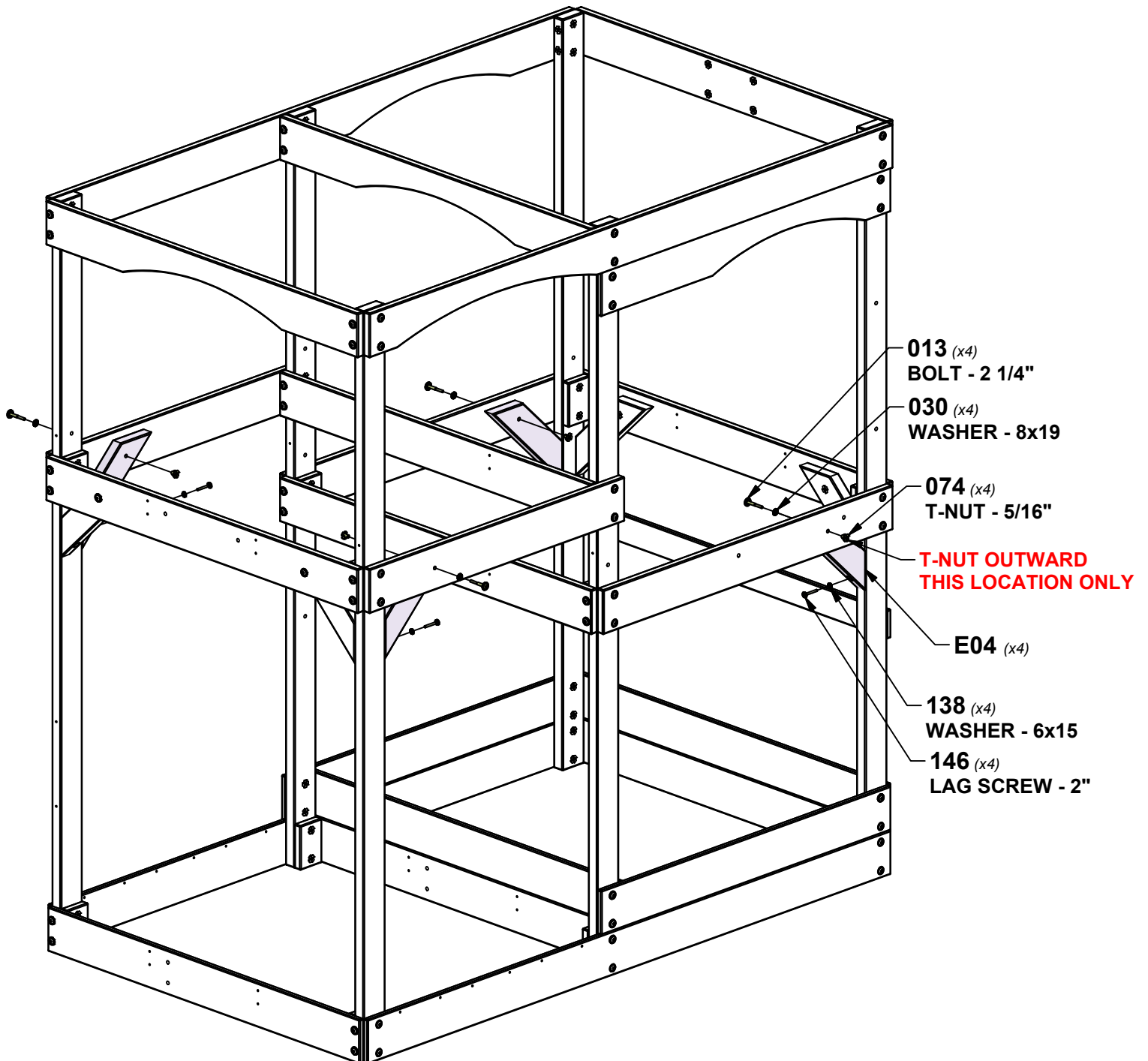

# STEP 8 - FORT ASSEMBLY

QTY	PART NUMBER	DESCRIPTION
24	H100090	SCREW PFH 8x2 1/2
2	H100128	SCREW PWH 8x5/8

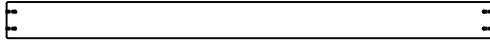

**H01** | FLOOR JOIST - W4L16023  
(x2) | 1"x3 3/8"x45 1/2" (24x86x1156)

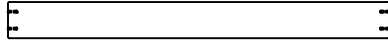

**H09** | FLOOR JOIST - W4L16032  
(x2) | 1"x3 3/8"x35 3/4" (24x86x908)

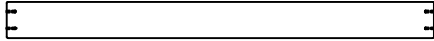

**H03** | FLOOR JOIST - W4L16026  
(x2) | 1"x3 3/8"x40 1/8" (24x86x1018)



**A100314** | "A" REVISION TAG  
(x1)

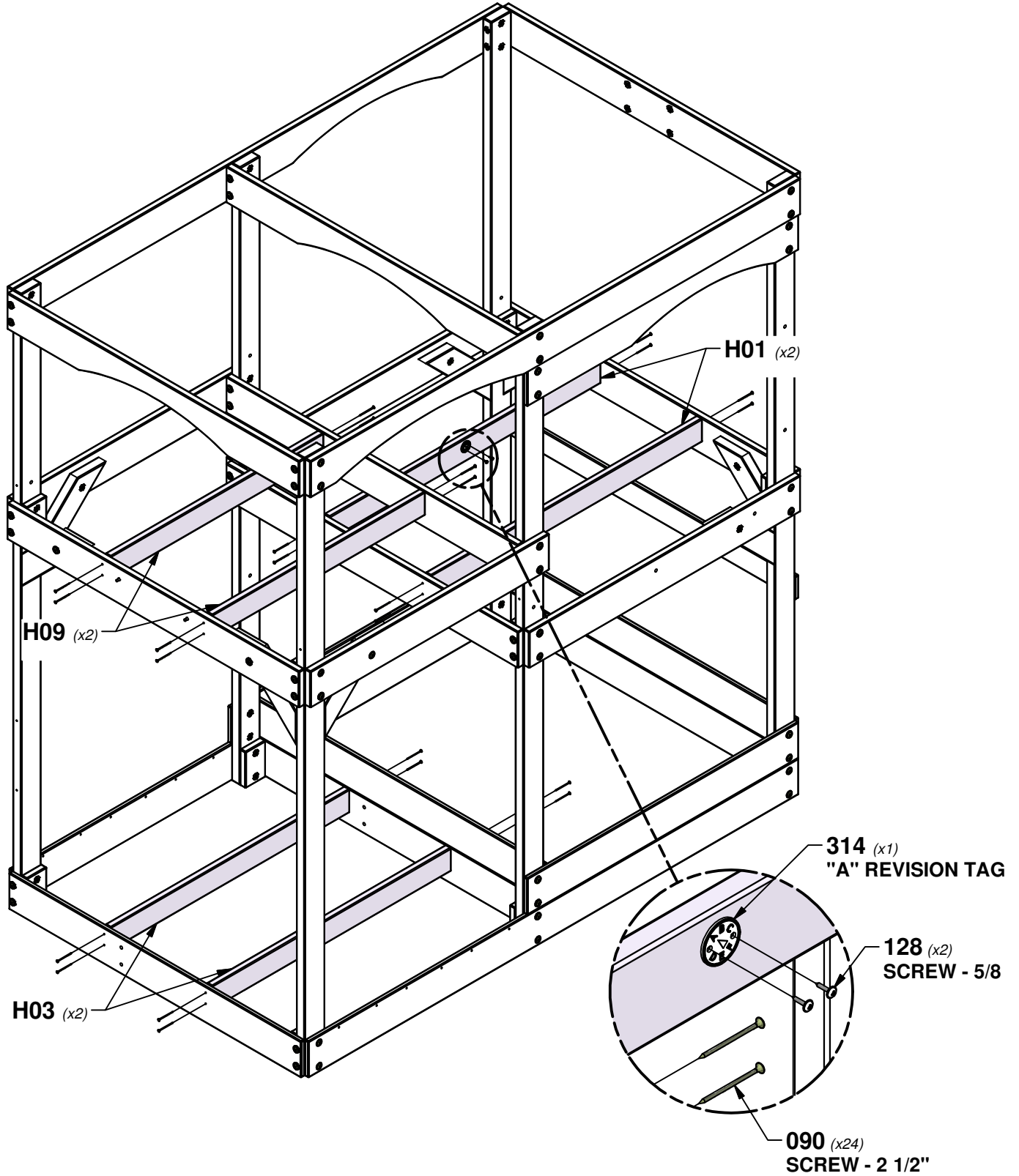

# STEP 9 - FORT ASSEMBLY



**H04** SEAT UPRIGHT - W4L16027  
(x2) 1"x3 3/8"x19" (24x86x482)

QTY	PART NUMBER	DESCRIPTION
4	H100010	BOLT WH 5/16x1 1/2
4	H100030	WASHER LOCK EXT 8x19
4	H100074	T-NUT 5/16

**TIP:**  
INSTALL T-NUTS IN WOOD FIRST

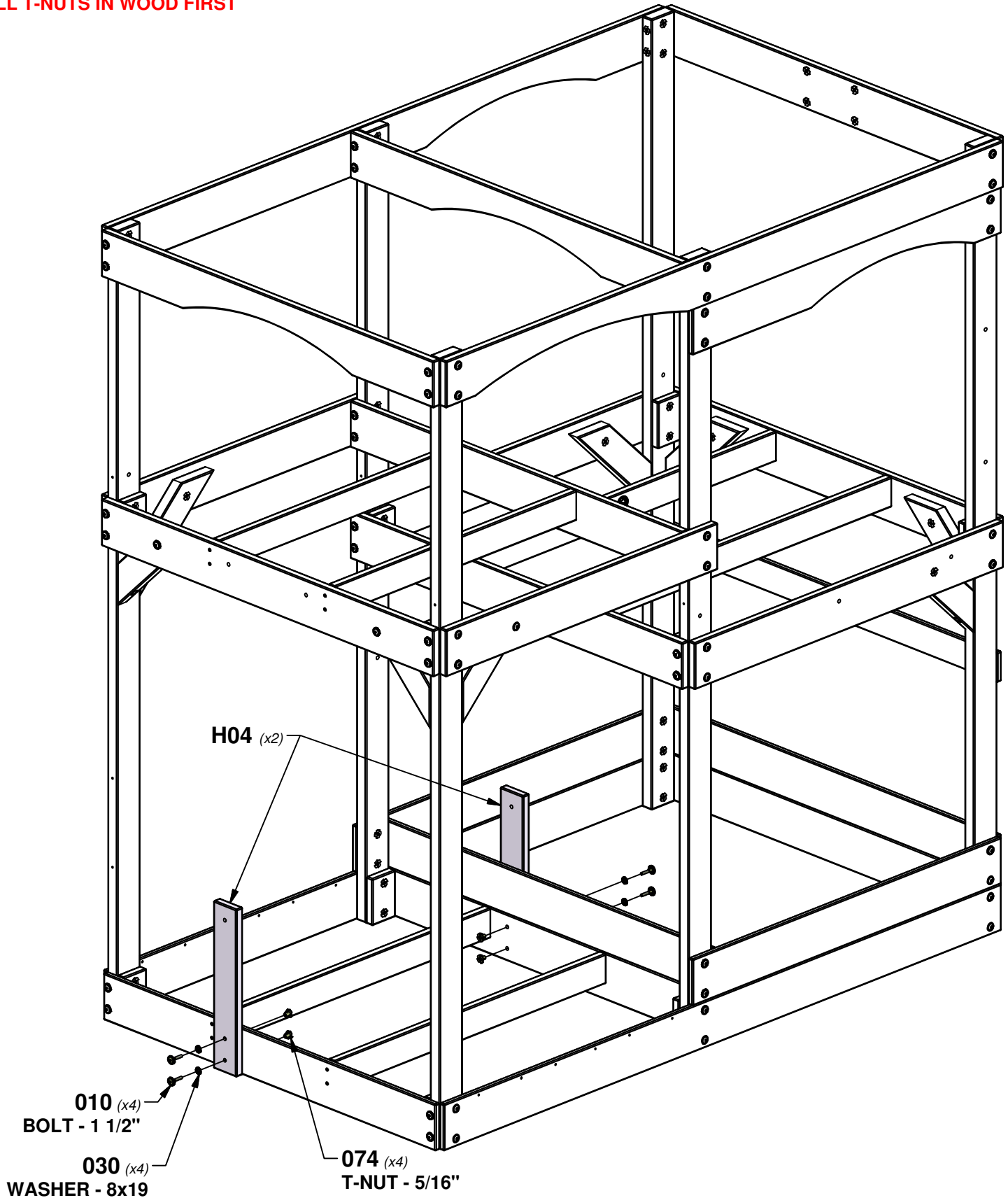

# STEP 10 - FORT ASSEMBLY

QTY	PART NUMBER	DESCRIPTION
26	H100086	SCREW PFH 8x1-1/2"
12	H100089	SCREW PFH 8x1-3/4"

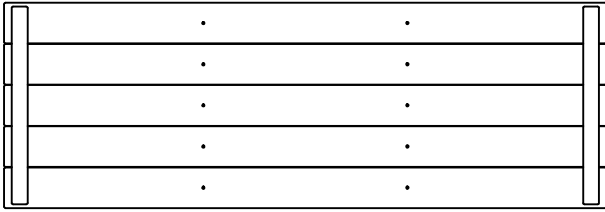

**FP1** | FLOOR PANEL - W2A03281  
(x1) | 1 5/8"x17 1/8"x50 1/4" (40x434x1276)



**FP2** | FLOOR PANEL - W2A03282  
(x1) | 1 5/8"x16 1/8"x50 1/4" (40x408x1276)



**M02** | FLOOR BOARD - W4L16055  
(x1) | 5/8"x3 3/8"x46" (16x86x1168)

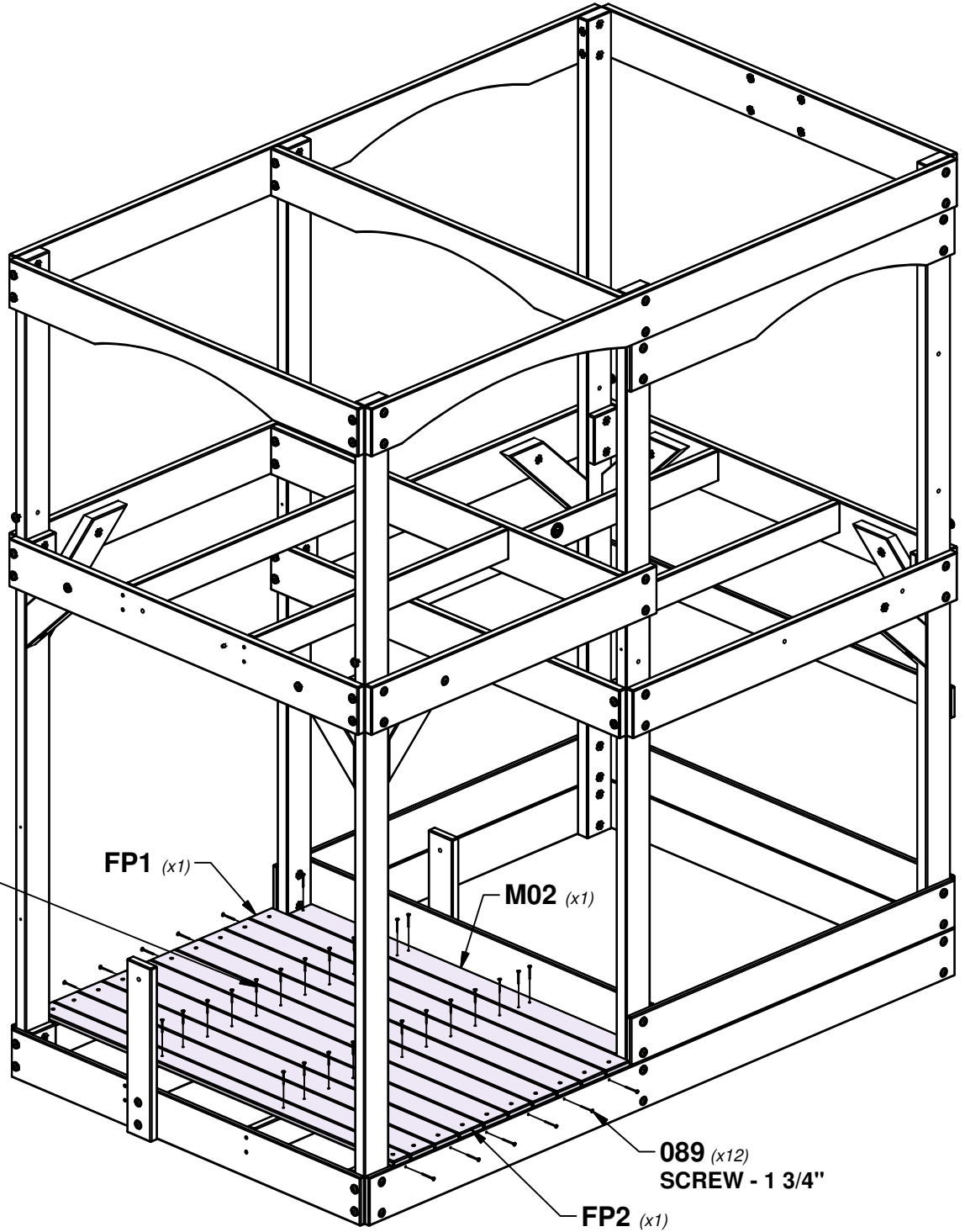

**086** (x26)  
SCREW - 1 1/2"

**FP1** (x1)

**M02** (x1)

**089** (x12)  
SCREW - 1 3/4"

**FP2** (x1)

# STEP 11 - FORT ASSEMBLY

QTY	PART NUMBER	DESCRIPTION
78	H100086	SCREW PFH 8x1-1/2"

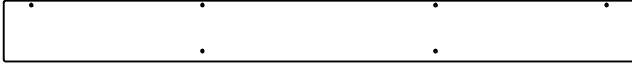

**L01** | OUTSIDE FILLER FLOOR BOARD - W4L16039  
(x2) | 5/8"x4 3/8"x46" (16x112x1168)

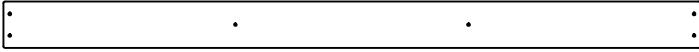

**M03** | FLOOR BOARD - W4L16063  
(x11) | 5/8"x3 3/8"x50 7/8" (16x86x1292)

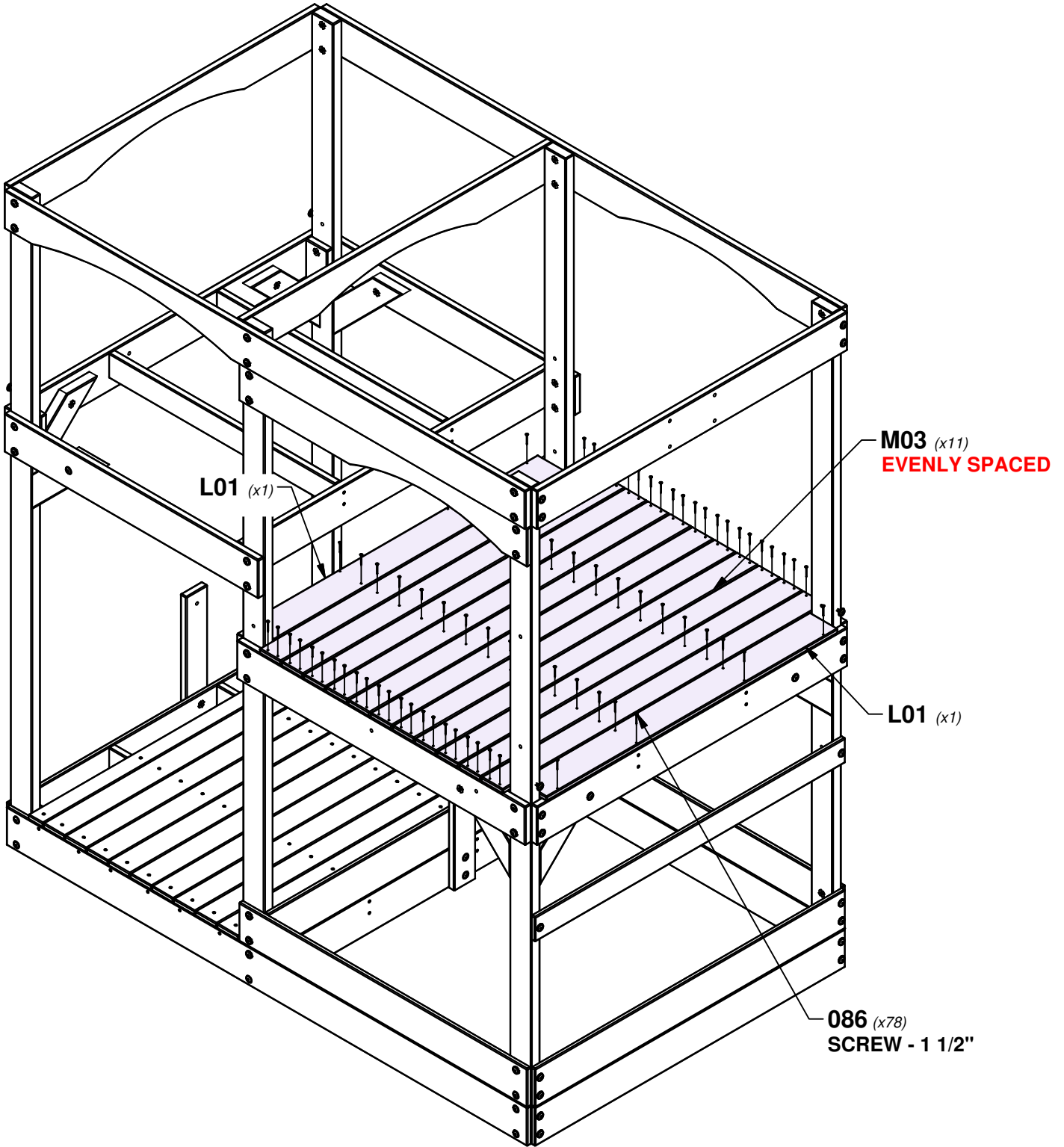

# STEP 12 - FORT ASSEMBLY

QTY	PART NUMBER	DESCRIPTION
2	H100011	BOLT WH 5/16x1 3/4
2	H100030	WASHER LOCK EXT 8x19
2	H100074	T-NUT 5/16

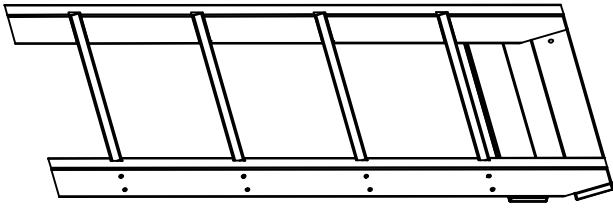

LADDER ASSEMBLY

**TIP:**  
INSTALL T-NUTS IN WOOD FIRST

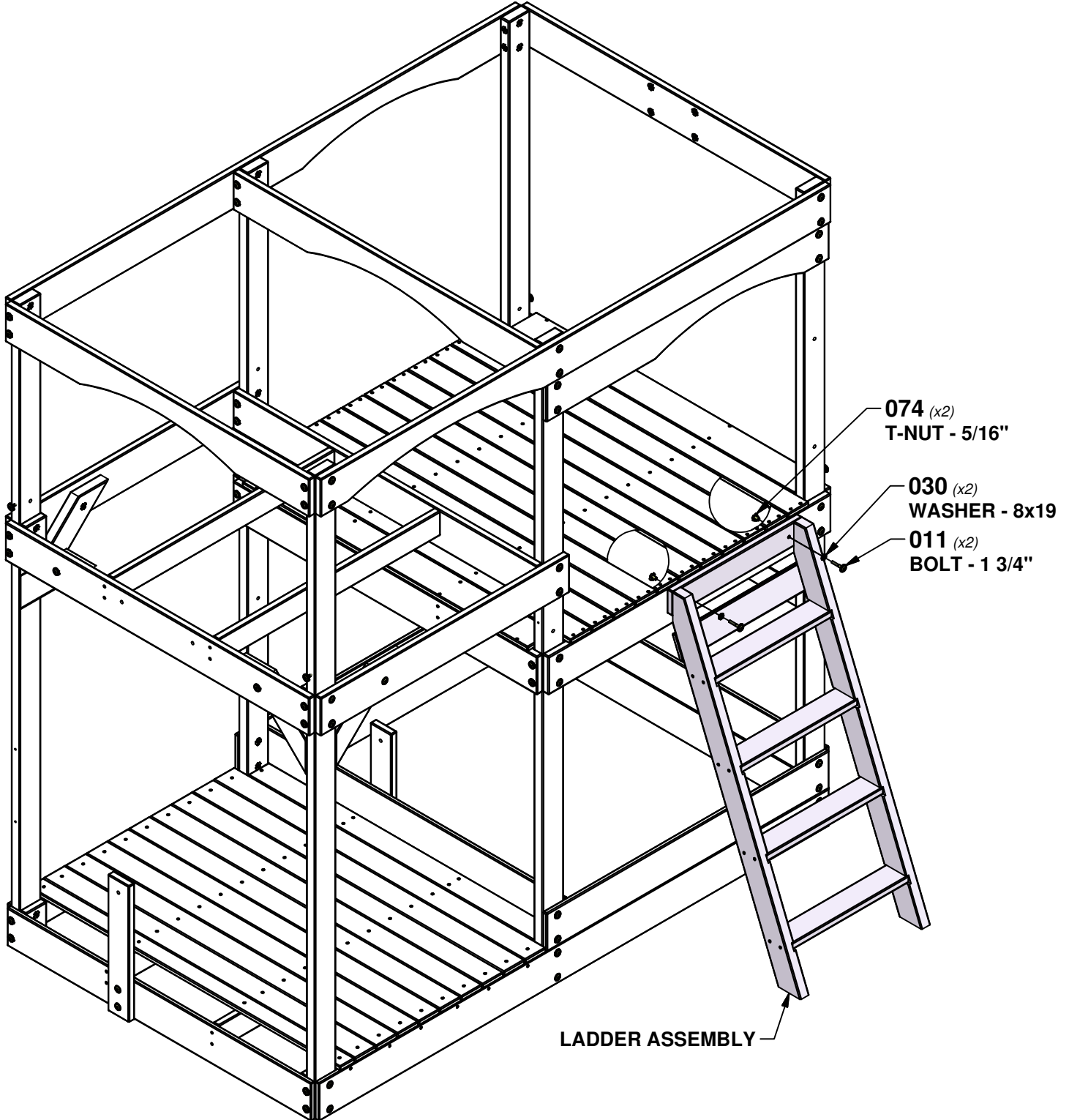

LADDER ASSEMBLY

# STEP 13 - FORT ASSEMBLY

QTY	PART NUMBER	DESCRIPTION
64	H100086	SCREW PFH 8x1-1/2"

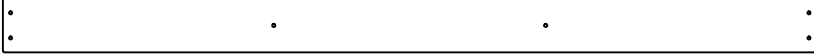

**M03** FLOOR BOARD - W4L16063  
(x9) 5/8"x3 3/8"x50 7/8" (16x86x1292)

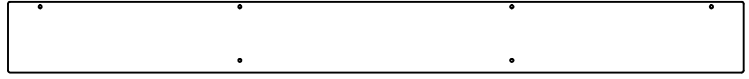

**L01** OUTSIDE FILLER FLOOR BOARD - W4L16039  
(x1) 5/8"x4 3/8"x46" (16x112x1168)

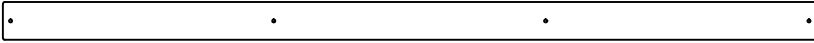

**N01** FLOOR BOARD - W4L16076  
(x1) 5/8"x2 3/8"x50 7/8" (16x60x1292)

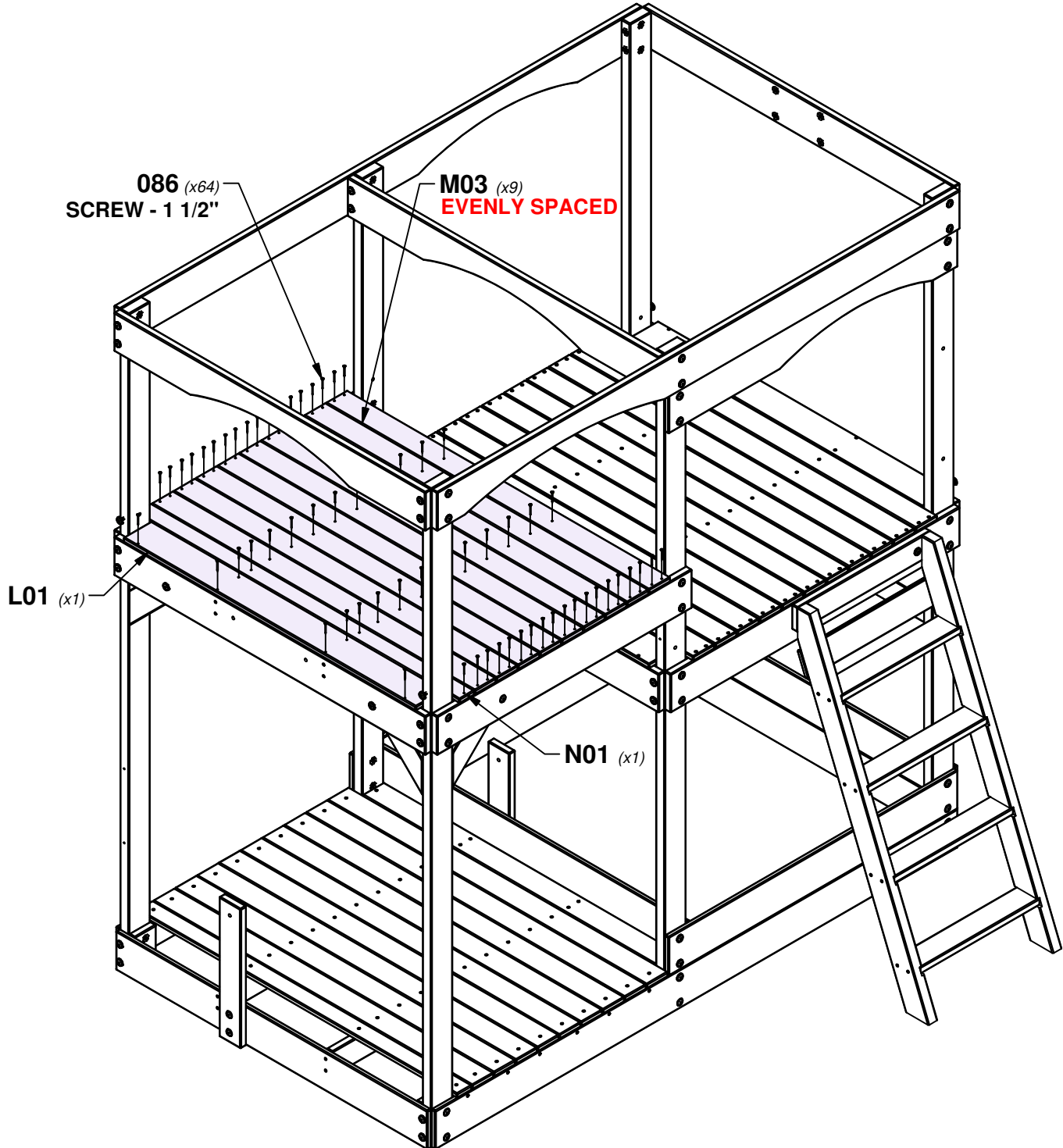

# STEP 14 - FORT ASSEMBLY

QTY	PART NUMBER	DESCRIPTION
6	H100012	BOLT WH 5/16x2
6	H100030	WASHER LOCK EXT 8x19
6	H100074	T-NUT 5/16



**M06** | WALL RAIL - W4L16067  
(x2) | 5/8"x3 3/8"x45 1/2" (16x86x1156)

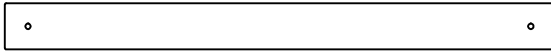

**M11** | WALL RAIL - W4L16047  
(x1) | 5/8"x3 3/8"x40 1/8" (16x86x1018)

**TIP:**  
INSTALL T-NUTS IN WOOD FIRST

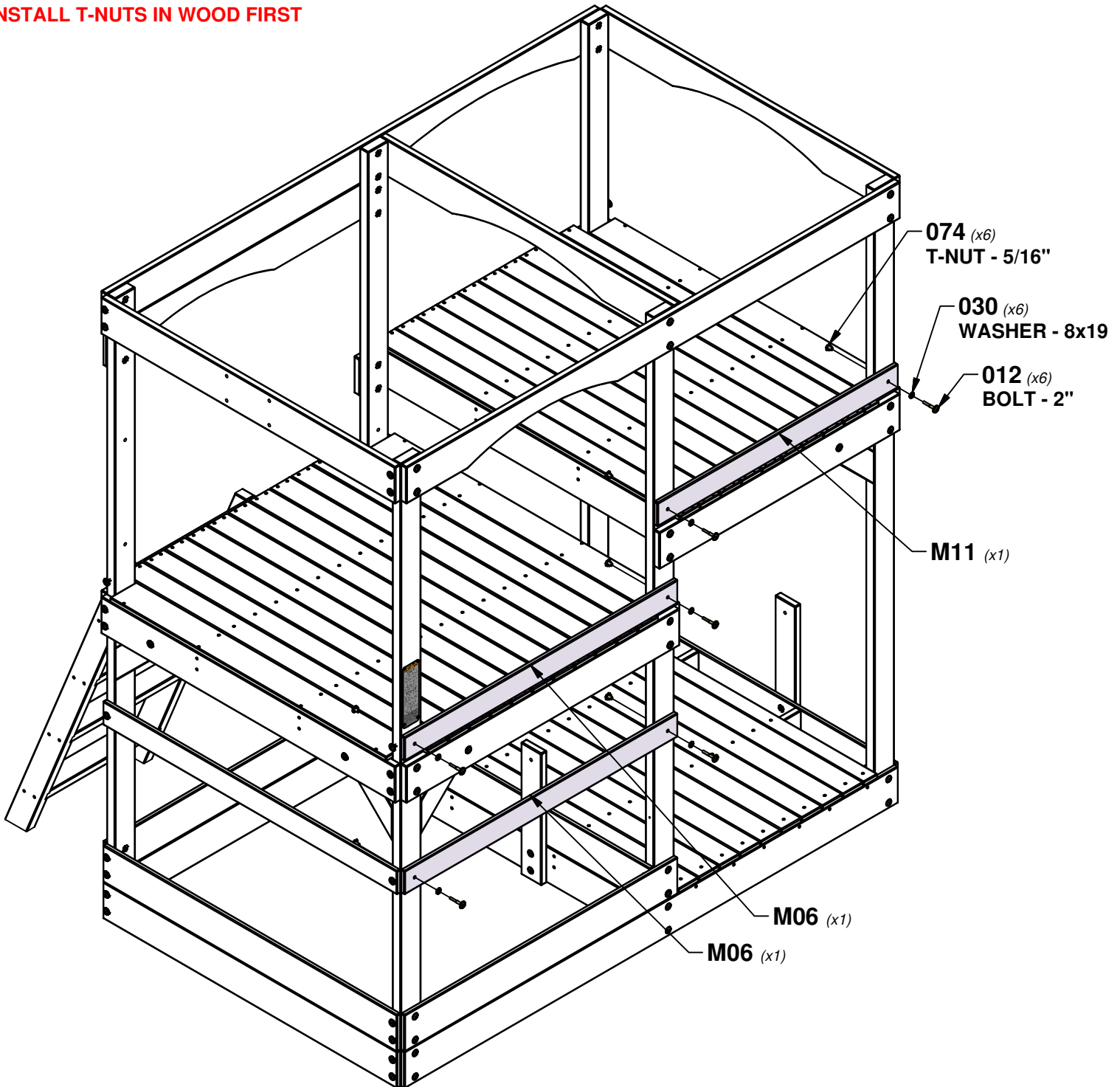

# STEP 15 - FORT ASSEMBLY

QTY	PART NUMBER	DESCRIPTION
1	H100012	BOLT WH 5/16x2
2	H100027	LAG SCREW WH 5/16x2
3	H100030	WASHER LOCK EXT 8x19
1	H100074	T-NUT 5/16



**M05** | WALL RAIL - W4L16066  
(x1) | 5/8"x3 3/8"x49" (16x86x1244)

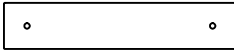

**M18** | WALL RAIL - W4L16053  
(x1) | 5/8"x3 3/8"x16 7/8" (16x86x430)

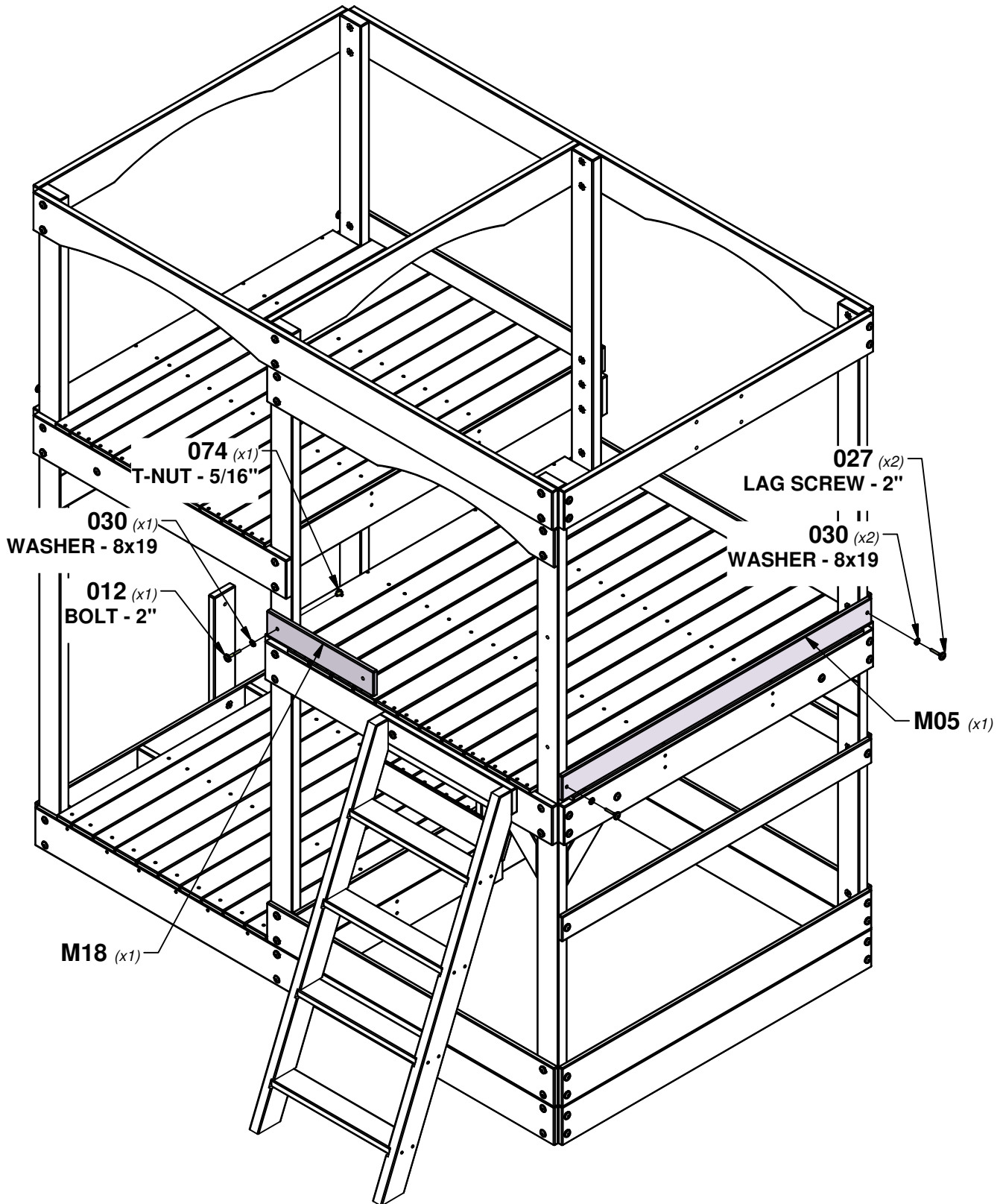

# STEP 16 - FORT ASSEMBLY

QTY	PART NUMBER	DESCRIPTION
2	H100027	LAG SCREW WH 5/16x2
2	H100028	LAG SCREW WH 5/16x2 1/2
4	H100030	WASHER LOCK EXT 8x19

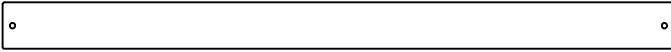

**M05** | WALL RAIL - W4L16066  
(x1) | 5/8"x3 3/8"x49" (16x86x1244)

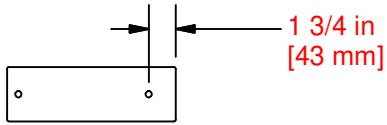

**M21** | WALL RAIL - W4L16057  
(x2) | 5/8"x3 3/8"x10 1/2" (16x86x268)

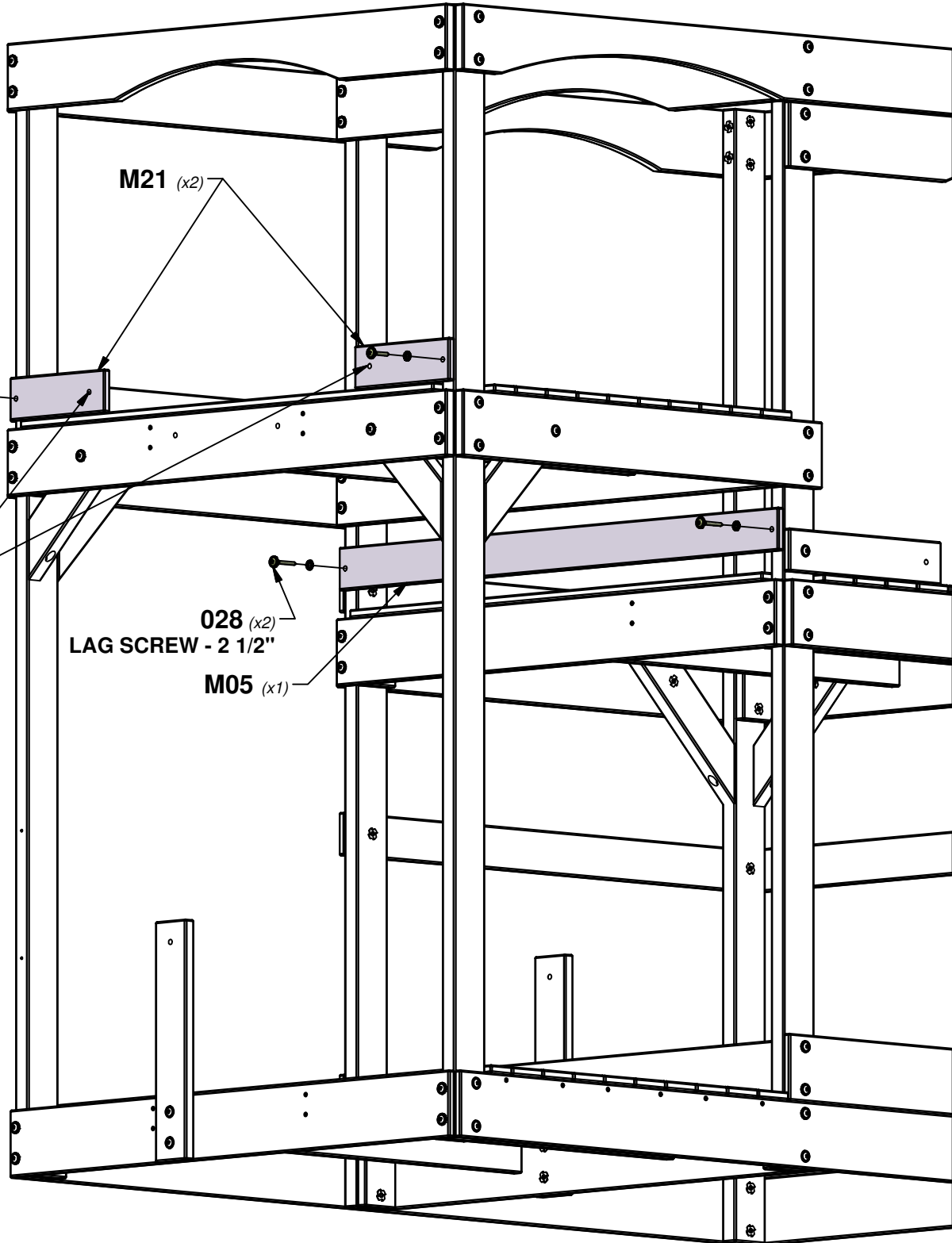

**030** (x4)  
WASHER - 8x19

**027** (x2)  
LAG SCREW - 2"

**1 3/4 in**  
**[43mm]**  
**HOLES TO INSIDE**

**028** (x2)  
LAG SCREW - 2 1/2"

**M05** (x1)

# STEP 17 - FORT ASSEMBLY

QTY	PART NUMBER	DESCRIPTION
24	H100088	SCREW PFH 8x1-1/8"



**M09** | WALL BOARD - W4L16075  
(x6) | 5/8"x3 3/8"x32" (16x86x812)

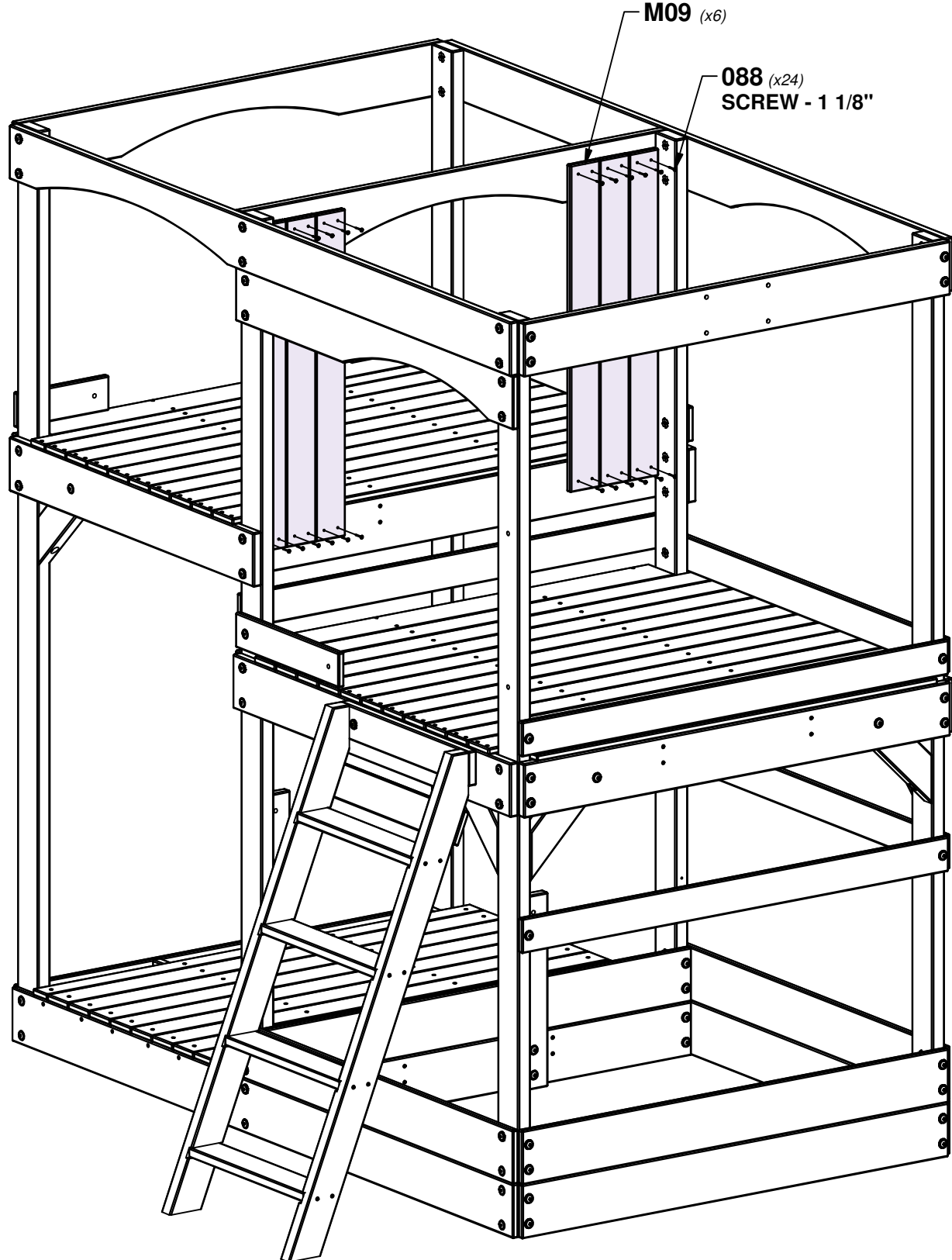
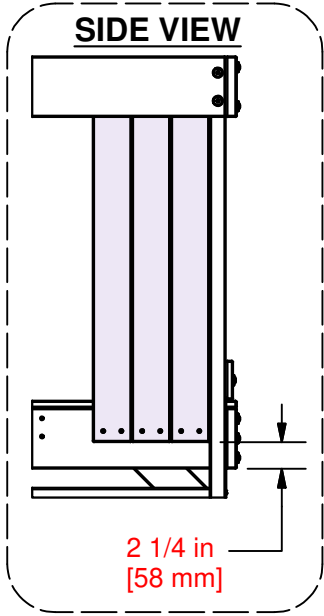

# STEP 18 - FORT ASSEMBLY



**M24** WALL BOARD - W4L16061  
(x2) 5/8"x3 3/8"x29 5/8" (16x86x752)

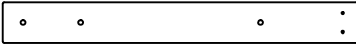

**M26** WALL BOARD - W4L16091  
(x2) 5/8"x3 3/8"x29 5/8" (16x86x752)



**A4M01046** L BRACKET  
(x2) 2.5x38x55x55

**TOP**

QTY	PART NUMBER	DESCRIPTION
2	H100005	NUT BARREL WH 5/16x7/8
2	H100008	BOLT WH 5/16x1
2	H100031	WASHER LOCK EXT 12x19
2	H100074	T-NUT 5/16
12	H100088	SCREW PFH 8x1-1/8"
2	H100115	BOLT WH 5/16x1/2

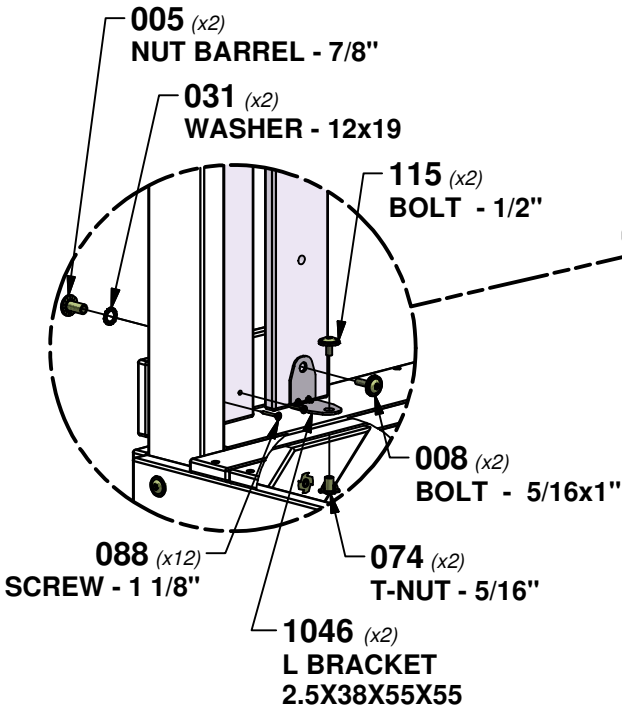
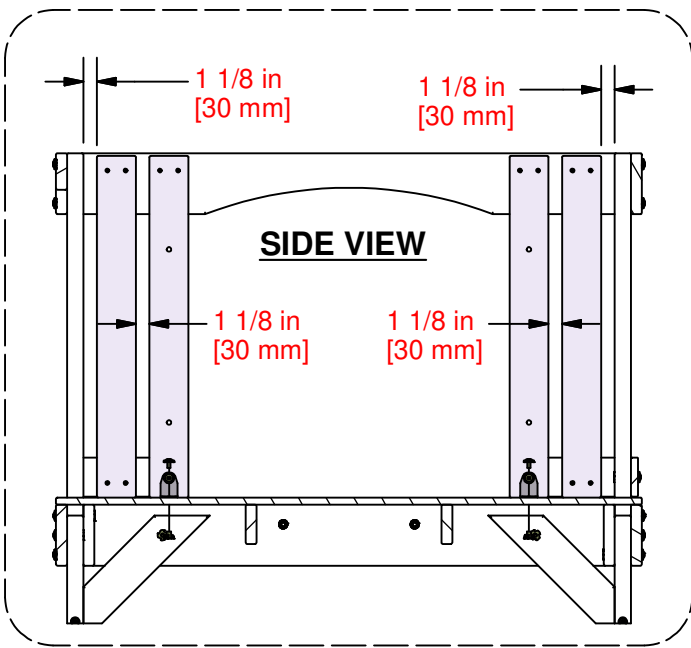

**USING L BRACKET AS A GUIDE, DRILL (2) 3/8 in [10 mm] HOLES THRU FLOOR FOR HARDWARE**

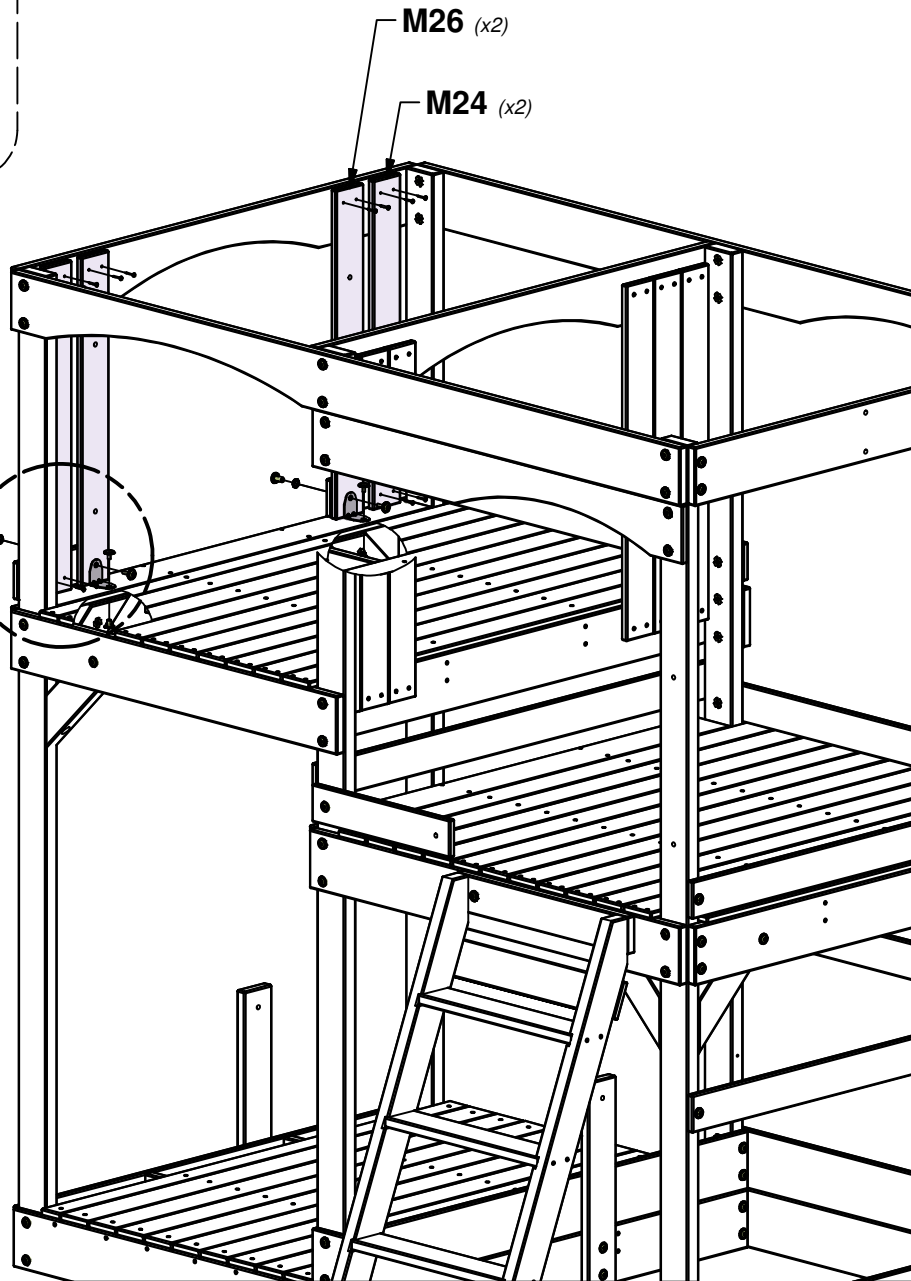

# STEP 19 - FORT ASSEMBLY

QTY	PART NUMBER	DESCRIPTION
20	H100088	SCREW PFH 8x1-1/8"



**M24** | WALL BOARD - W4L16061  
(x5) | 5/8"x3 3/8"x29 5/8" (16x86x752)

## SIDE VIEW

2 3/4 in TYPICAL SPACING  
[69 mm]

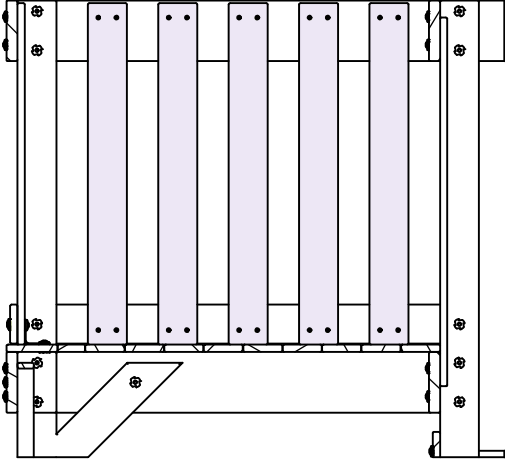

USE A6P00410 PICKET PAL FOR SPACING

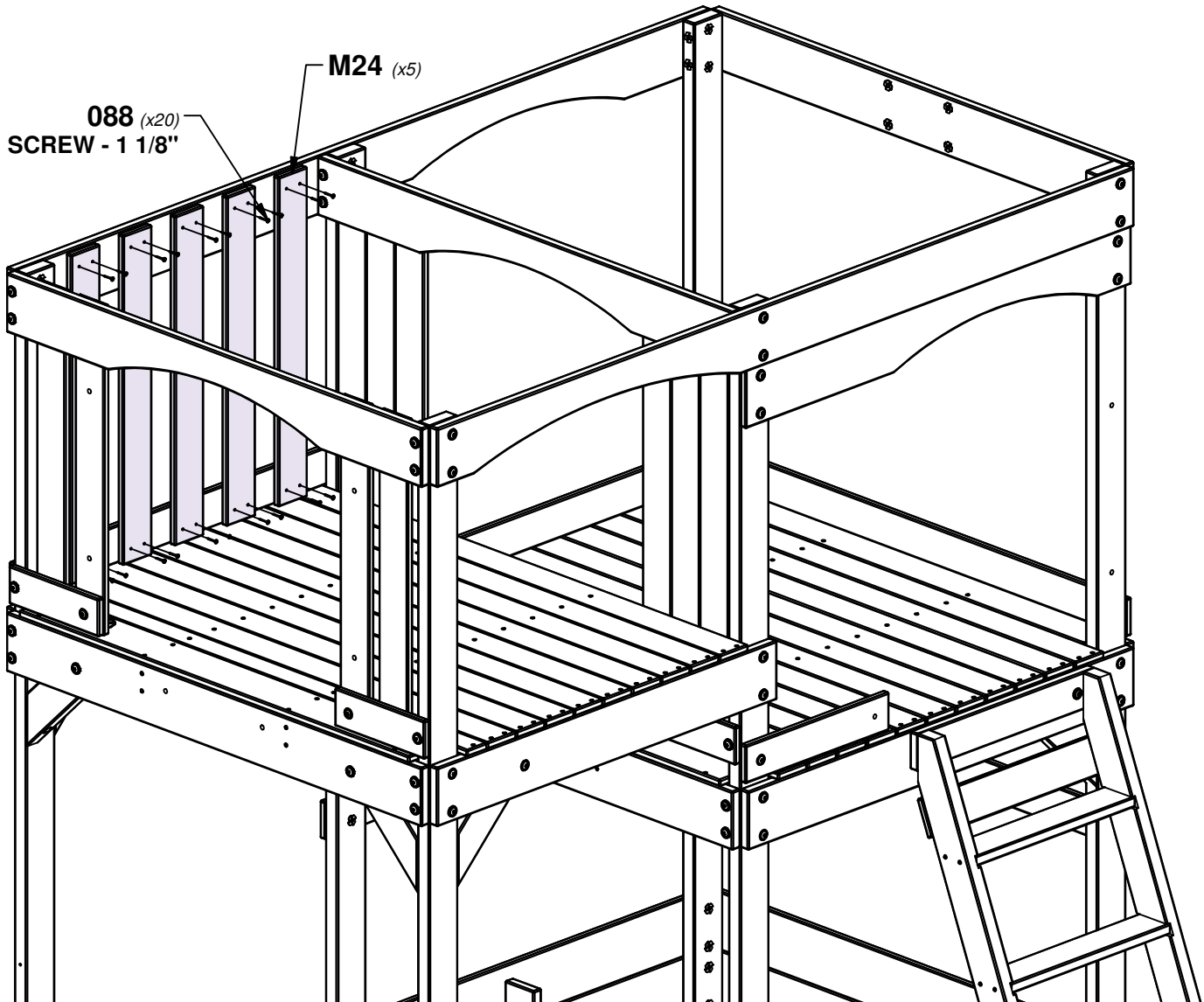

# STEP 20 - FORT ASSEMBLY

QTY	PART NUMBER	DESCRIPTION
16	H100088	SCREW PFH 8x1-1/8"

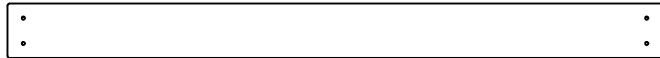

**M08** | WALL BOARD - W4L16074  
(x2) | 5/8"x3 3/8"x41" (16x86x1040)

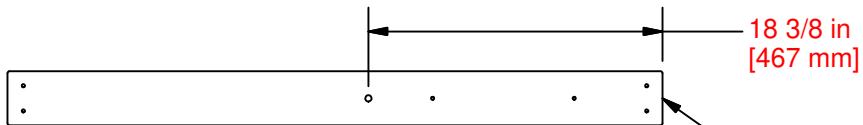

**M17** | WALL BOARD - W4L16090  
(x2) | 5/8"x3 3/8"x41" (16x86x1040)

**TOP**

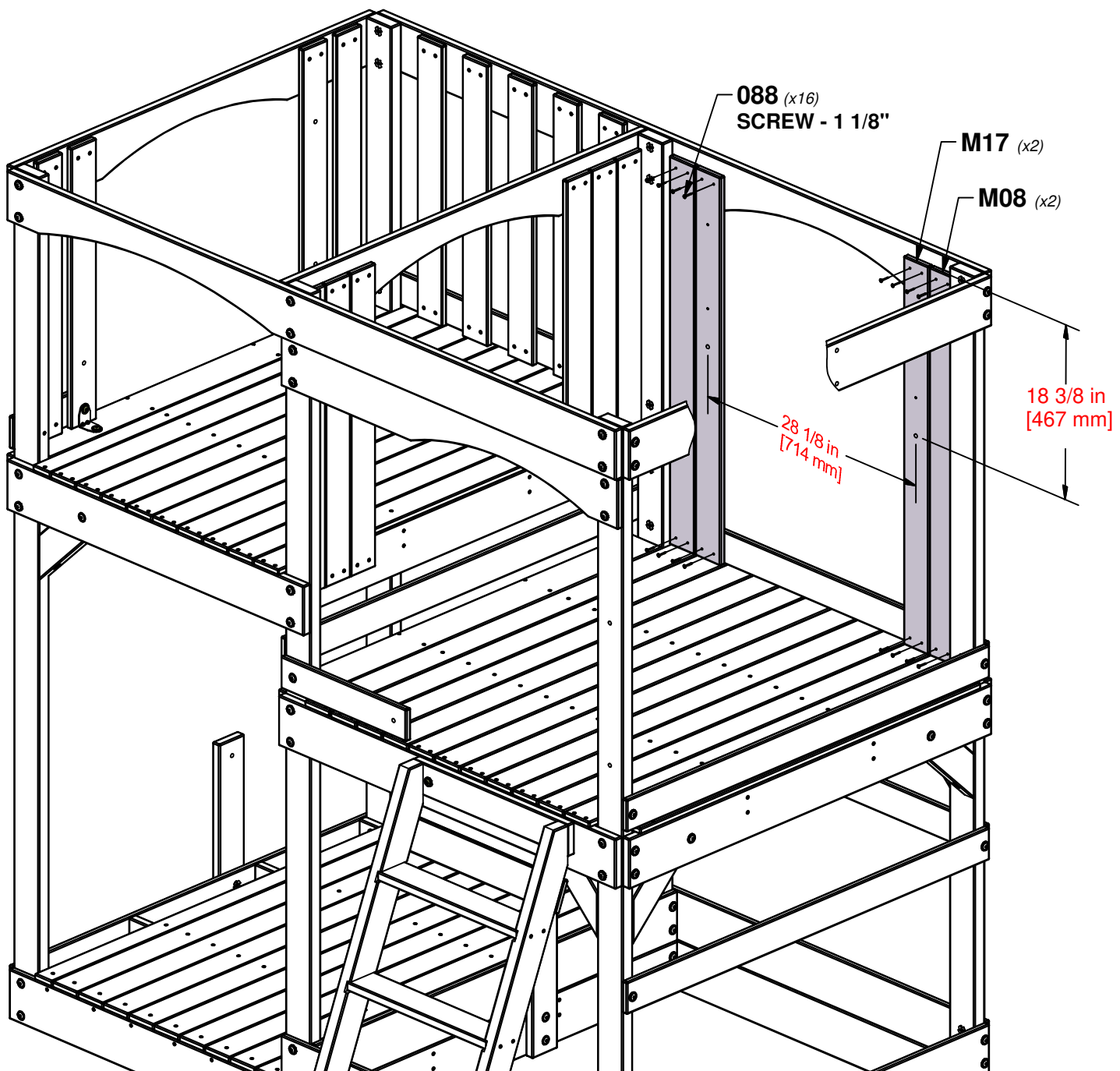

# STEP 21 - FORT ASSEMBLY

QTY	PART NUMBER	DESCRIPTION
2	H100009	BOLT WH 5/16x1 1/4
2	H100030	WASHER LOCK EXT 8x19
2	H100074	T-NUT 5/16
28	H100088	SCREW PFH 8x1-1/8"



**M12** WINDOW TRIM - W4L16048  
(x1) 5/8"x3 3/8"x31 1/2" (16x86x800)



**M13** WALL BOARD - W4L16049  
(x7) 5/8"x3 3/8"x24" (16x86x610)

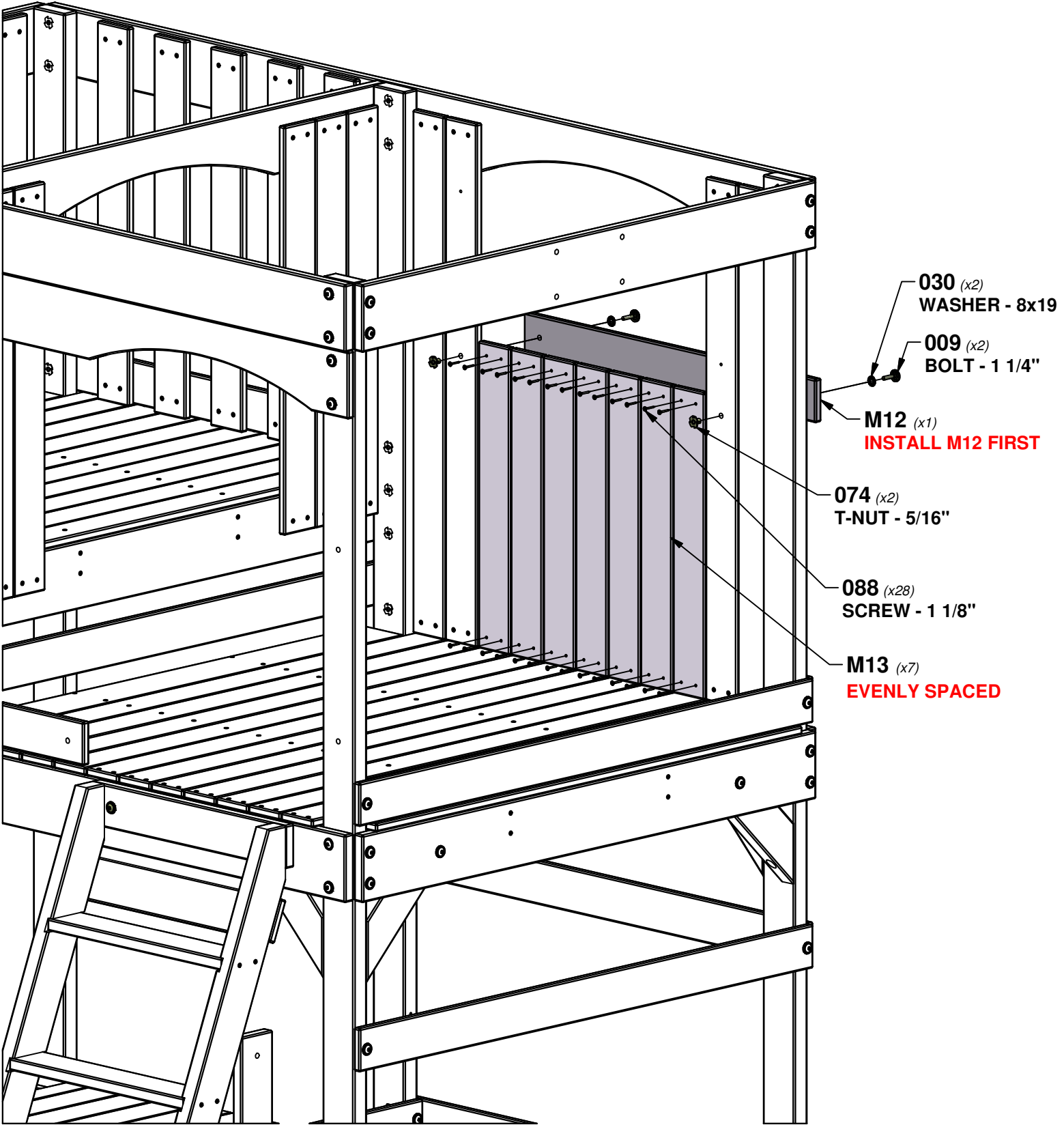

# STEP 22 - FORT ASSEMBLY

QTY	PART NUMBER	DESCRIPTION
4	H100088	SCREW PFH 8x1-1/8"

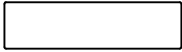

**M23** | WINDOW TRIM - W4L16059  
(x2) | 5/8"x3 3/8"x12 7/8" (16x86x328)

**SIDE VIEW**

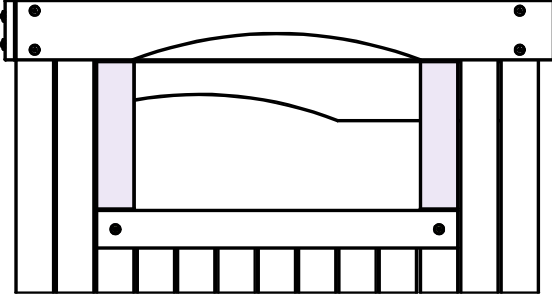

**CORRECT BOARD ASSEMBLY**

**088** (x4)  
SCREW - 1 1/8"

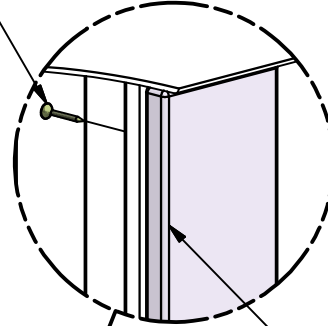

**M23** (x2)

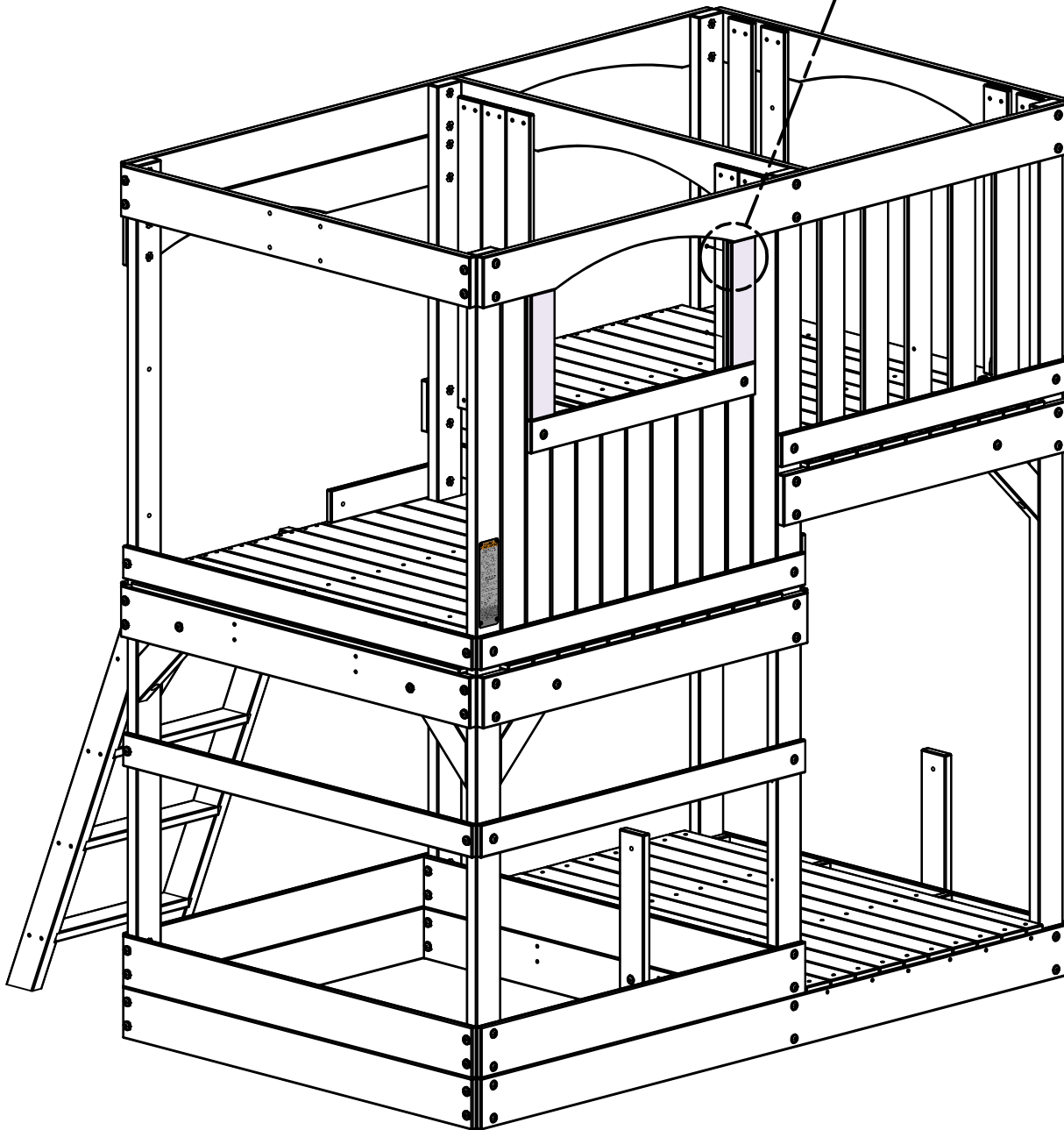

# STEP 23 - FORT ASSEMBLY

QTY	PART NUMBER	DESCRIPTION
48	H100088	SCREW PFH 8x1-1/8"



**M08** | WALL BOARD - W4L16074  
(x7) 5/8"x3 3/8"x41" (16x86x1040)

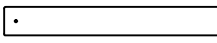

**N03** | WALL BOARD - W4L16078  
(x2) 5/8"x2 3/8"x18" (16x60x456)



**N05** | WALL BOARD - W4L16080  
(x2) 5/8"x2 3/8"x7" (16x60x178)

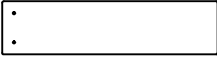

**L02** | WALL BOARD - W4L16040  
(x4) 5/8"x4 3/8"x18" (16x112x456)



**L03** | WALL BOARD - W4L16041  
(x4) 5/8"x4 3/8"x7" (16x112x178)

**FLUSH TOPS OF L03 & N05 BOARDS  
WITH TOP OF M08 BOARDS**

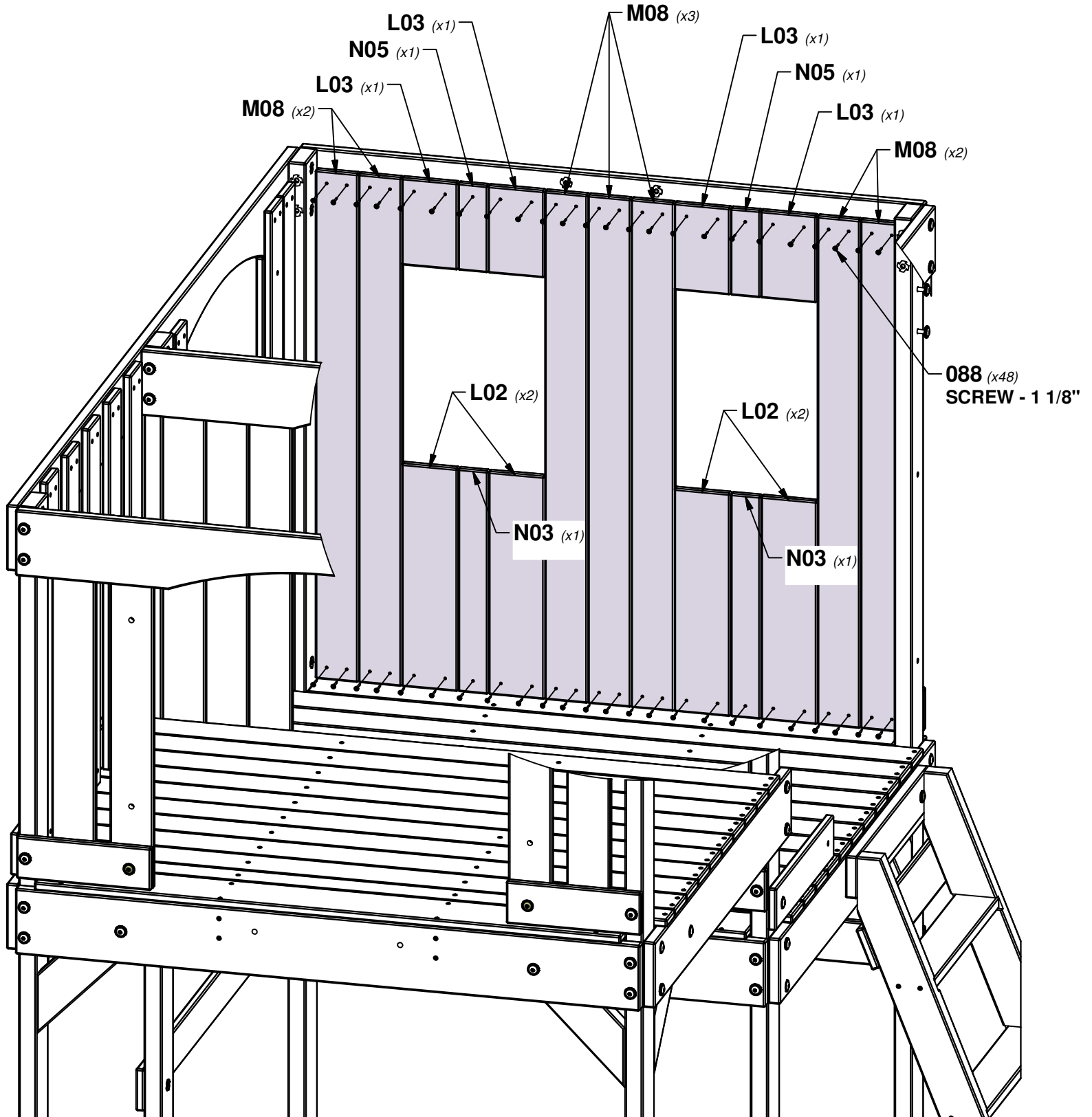

# STEP 24 - FORT ASSEMBLY

QTY	PART NUMBER	DESCRIPTION
8	H100070	SCREW PWH 8x3/4
10	H100088	SCREW PFH 8x1-1/8"

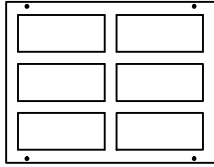

**PLASTIC WINDOW BYD GREEN**  
**A100010 (x2)**  
**343x444.5**



**001 WALL SUPPORT - W4L16081**  
**(x2) 5/8"x1 3/8"x13" (16x34x330)**

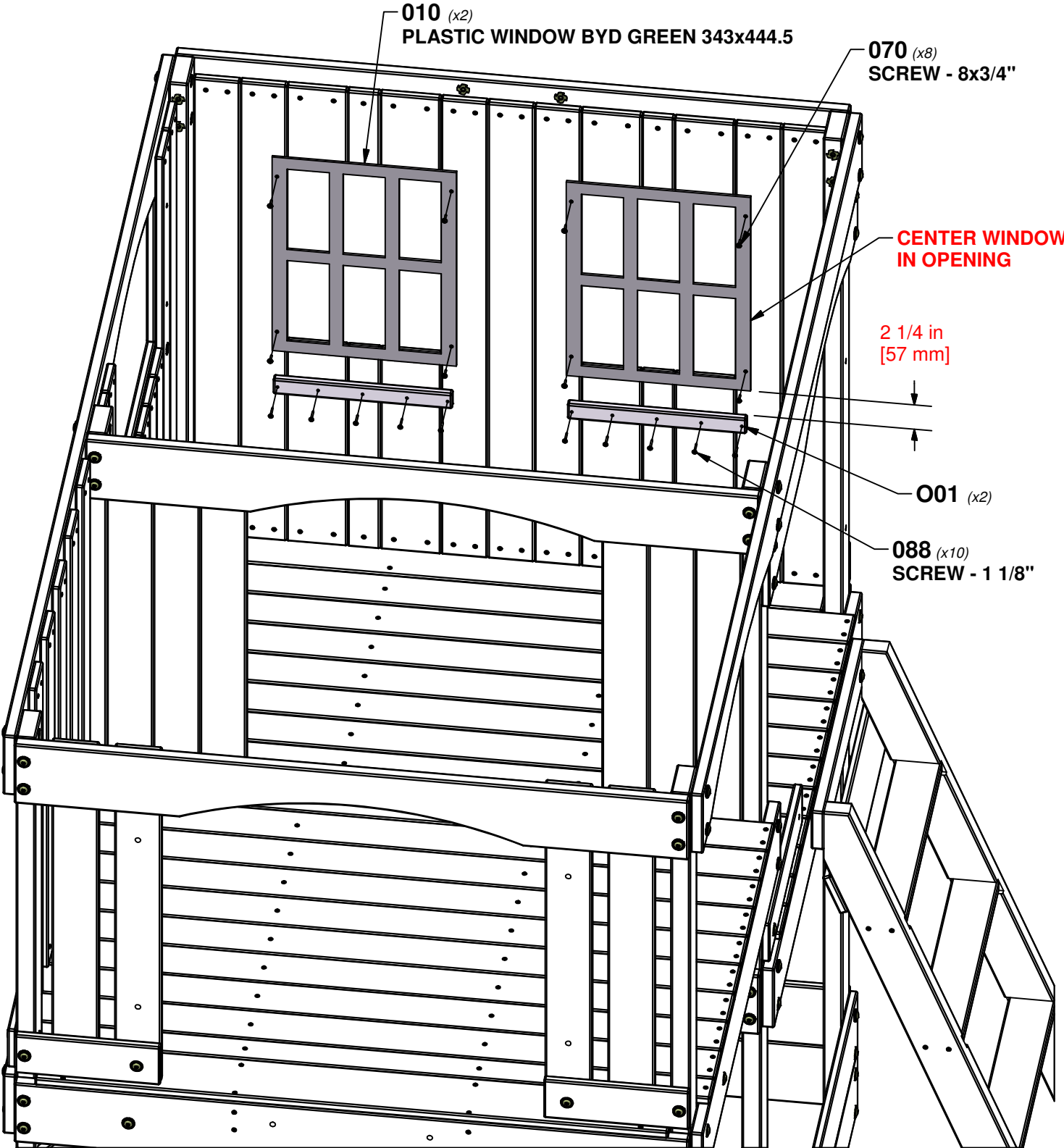

# STEP 25 - FORT ASSEMBLY

QTY	PART NUMBER	DESCRIPTION
12	H100086	SCREW PFH 8x1-1/2"

**O04** WINDOW SHUTTER SLAT - W4L16084  
 (x6) 5/8"x1 3/8"x5 3/8" (16x34x136)

**L04** WINDOW SHUTTER - W4L16042  
 (x3) 5/8"x4 3/8"x16" (16x112x406)

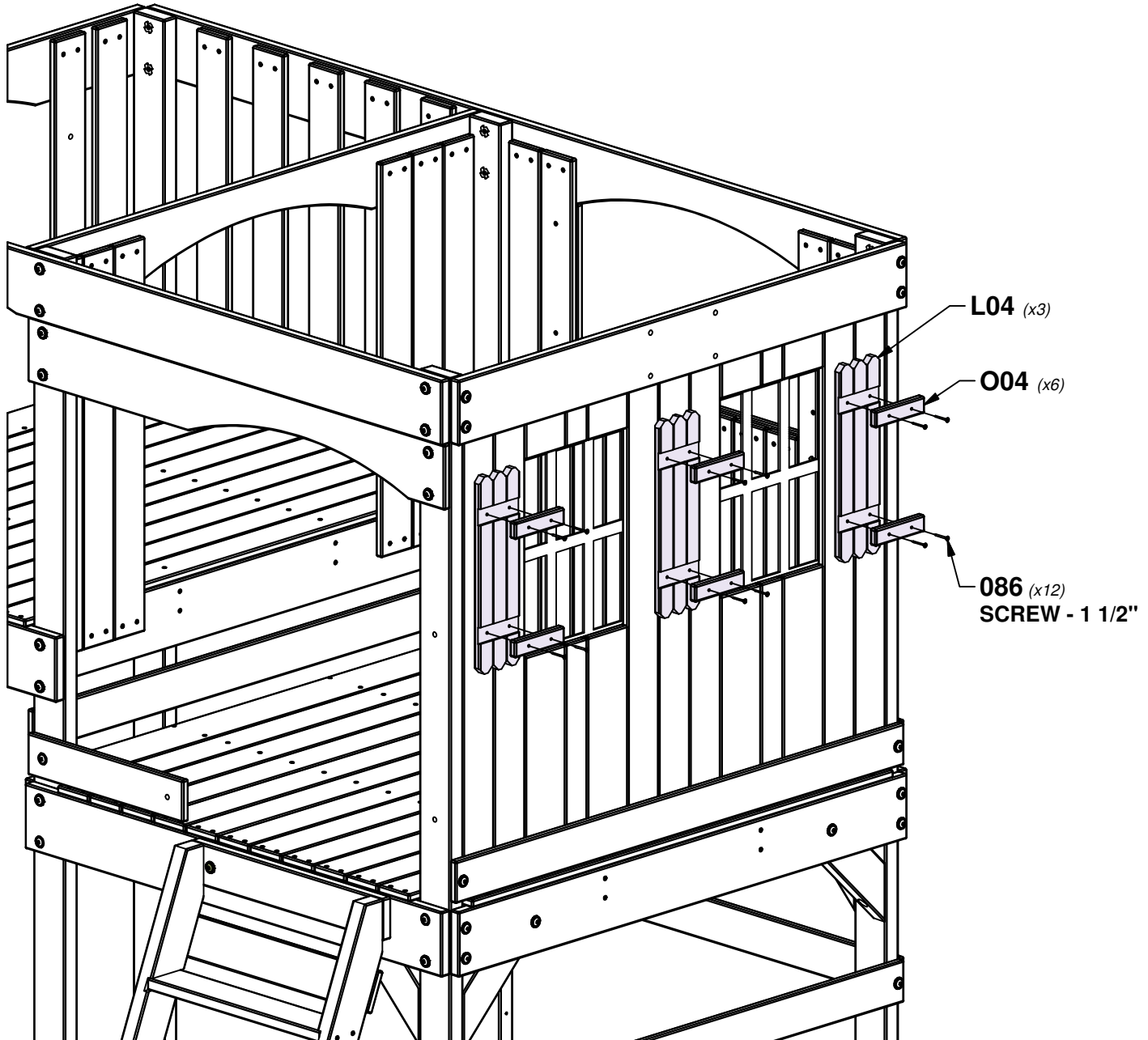
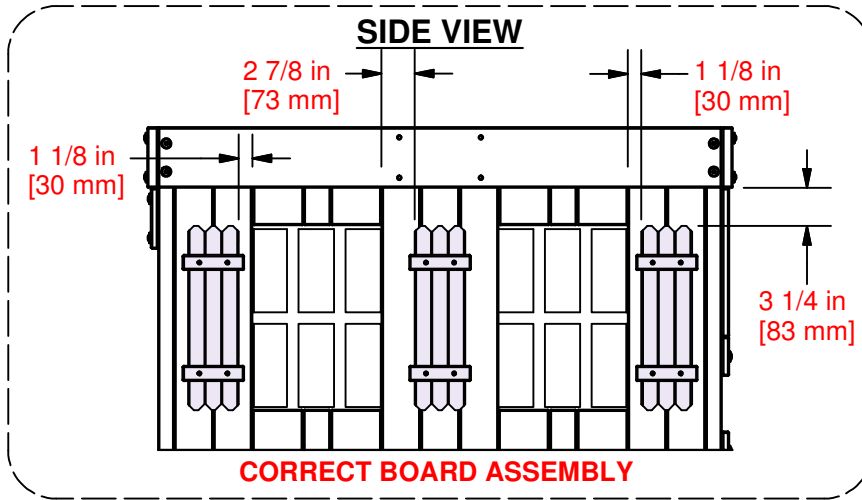

# STEP 26 - FORT ASSEMBLY

QTY	PART NUMBER	DESCRIPTION
1	H100005	NUT BARREL WH 5/16x7/8
1	H100008	BOLT WH 5/16x1
1	H100031	WASHER LOCK EXT 12x19
1	H100074	T-NUT 5/16
14	H100088	SCREW PFH 8x1-1/8"
1	H100115	BOLT WH 5/16x1/2



**M10** | WALL BOARD - W4L16044  
(x1) | 5/8"x3 3/8"x35" (16x86x888)

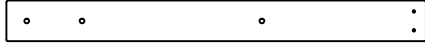

**M28** | WALL BOARD - W4L16064  
(x1) | 5/8"x3 3/8"x35" (16x86x888)



**A4M01046** | L BRACKET  
(x1) | 2.5x38x55x55

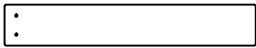

**M16** | WALL BOARD - W4L16052  
(x2) | 5/8"x3 3/8"x21" (16x86x532)



**M29** | WALL BOARD - W4L16060  
(x2) | 5/8"x3 3/8"x5" (16x86x126)

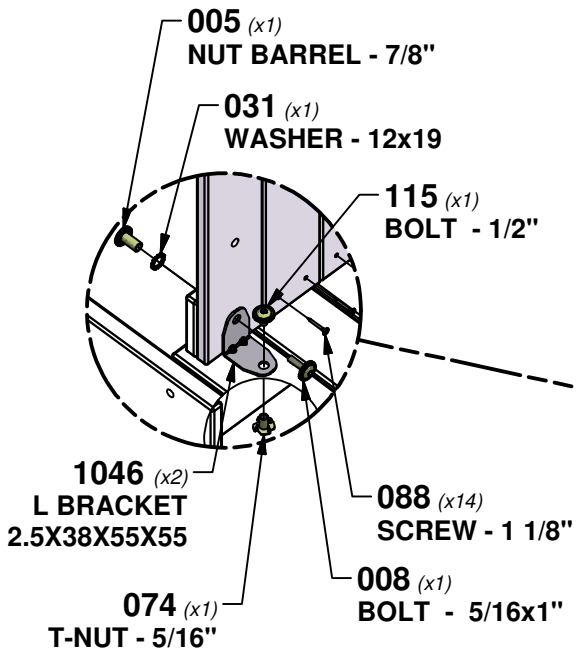

**USING L BRACKET AS A GUIDE,  
DRILL (1) 3/8 in [10 mm] HOLES  
THRU FLOOR FOR HARDWARE**

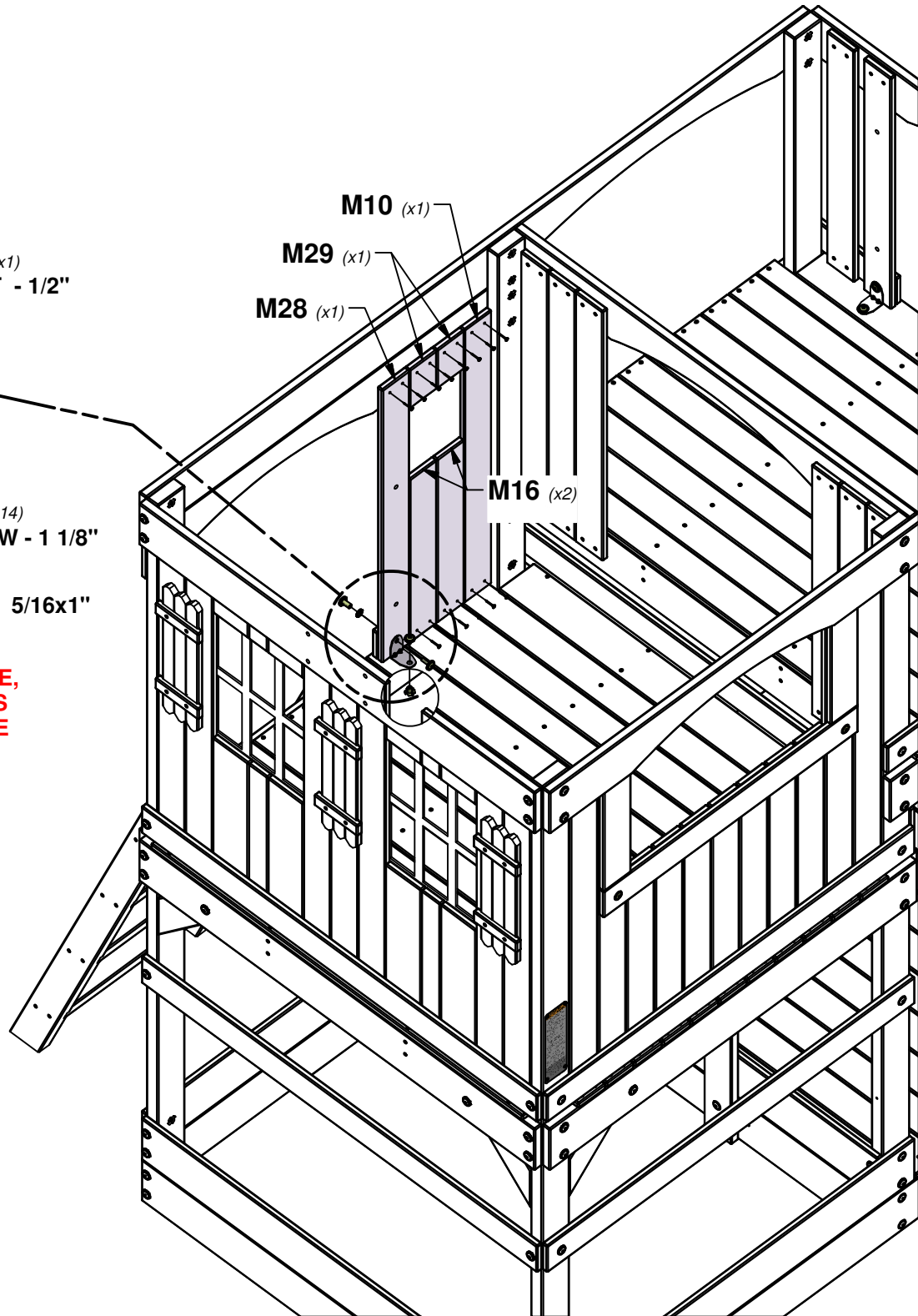

# STEP 27 - FORT ASSEMBLY

QTY	PART NUMBER	DESCRIPTION
4	H100070	SCREW PWH 8x3/4
4	H100088	SCREW PFH 8x1-1/8"

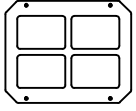

A100146 | WINDOW  
(x1) | 216x267 GREEN

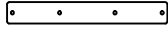

O02 | WALL SUPPORT - W4L16082  
(x1) | 5/8"x1 3/8"x10" (16x34x254)

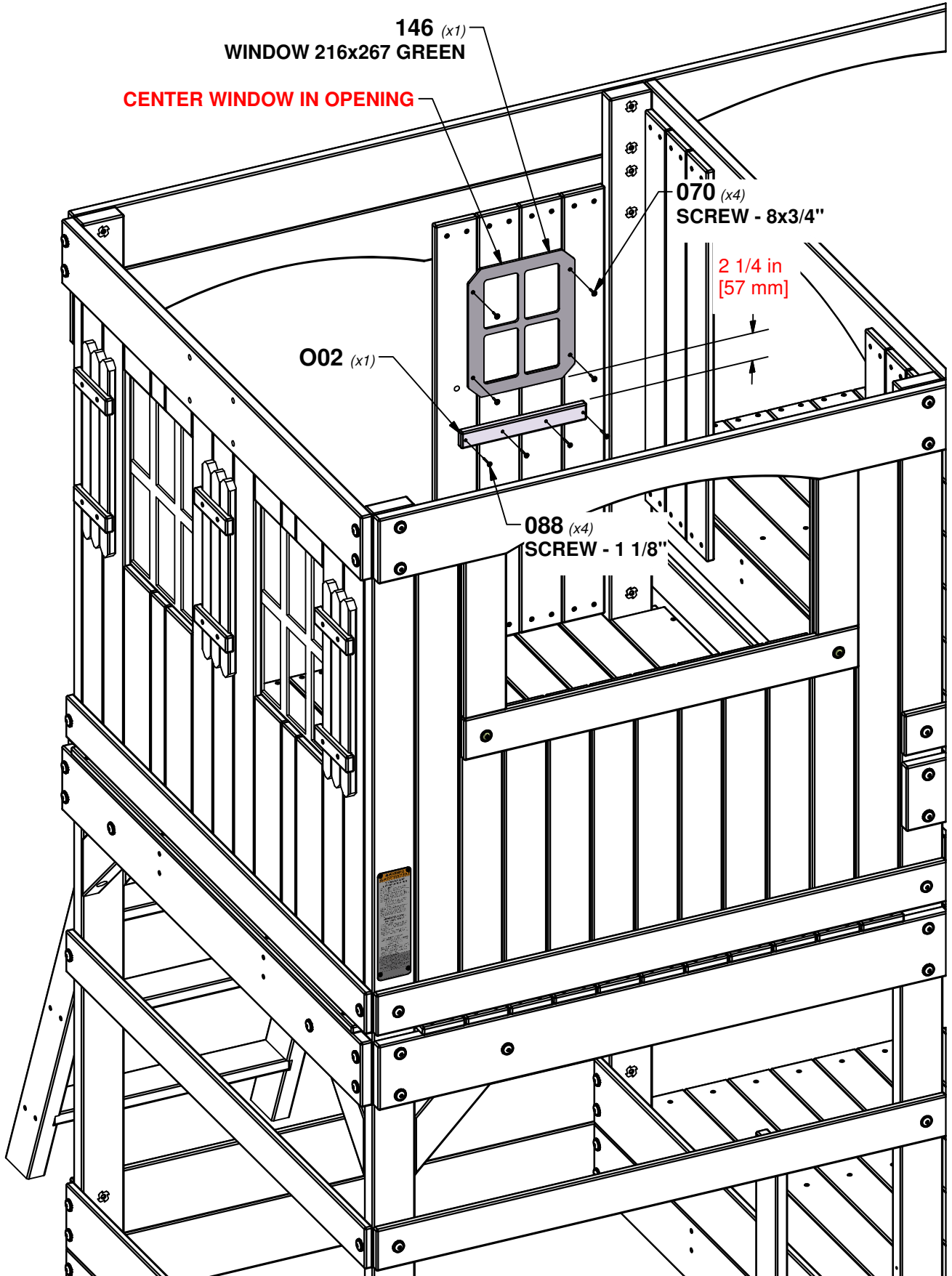

# STEP 28 - FORT ASSEMBLY

QTY	PART NUMBER	DESCRIPTION
8	H100086	SCREW PFH 8x1-1/2"
2	H100111	SCREW PFH 8x2"

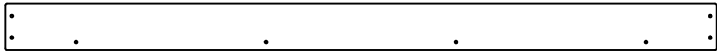

**M01** | ROOF CAP - W4L16043  
(x2) | 5/8"x3 3/8"x51 7/8" (16x86x1318)

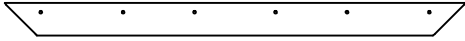

**J01** | ROOF RAFTER - W4L16033  
(x4) | 1"x2 3/8"x33 5/8" (24x60x854)

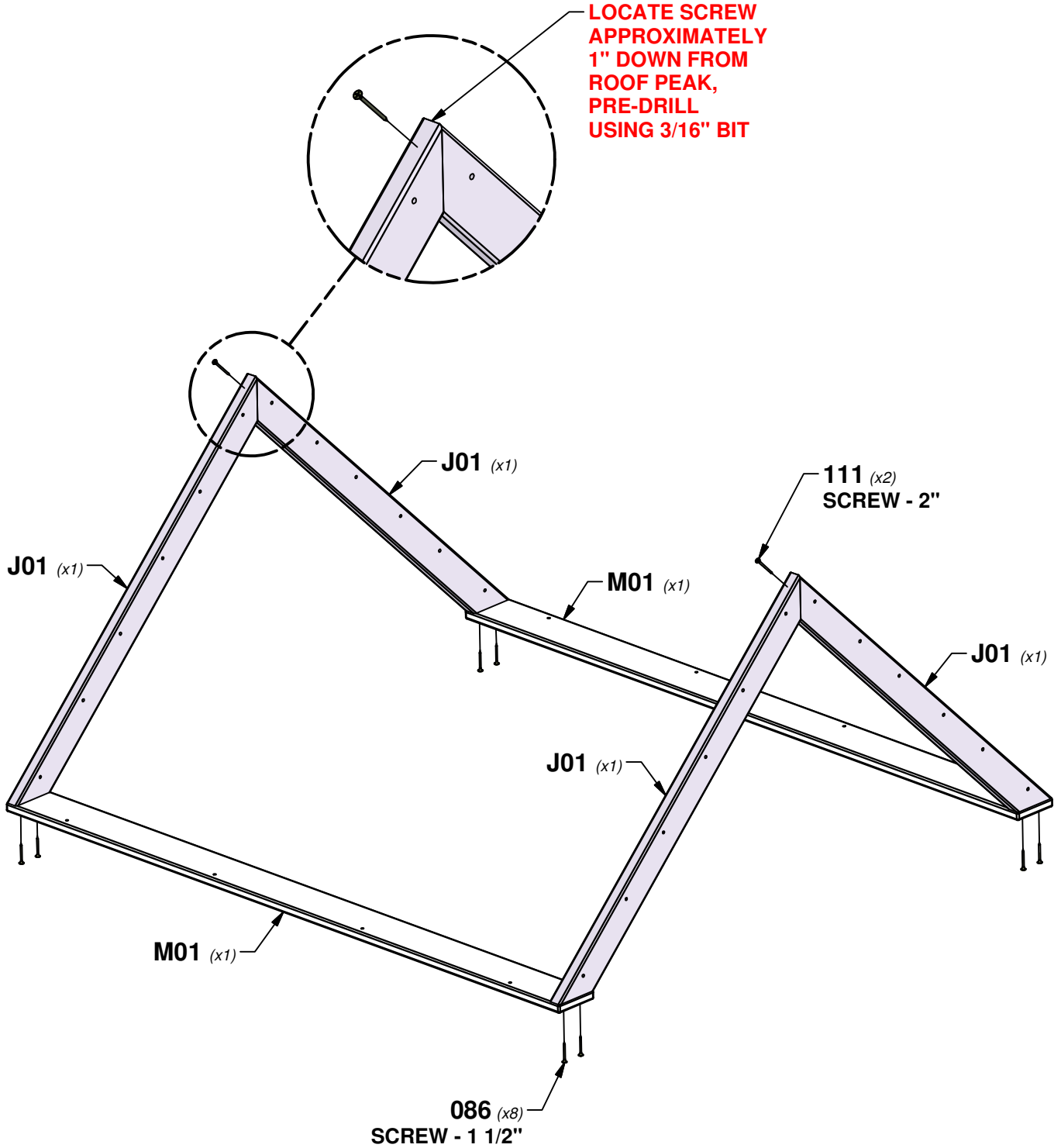

# STEP 29 - FORT ASSEMBLY

QTY	PART NUMBER	DESCRIPTION
8	H100090	SCREW PFH 8x2 1/2



**ROOF BASE ASSEMBLY**

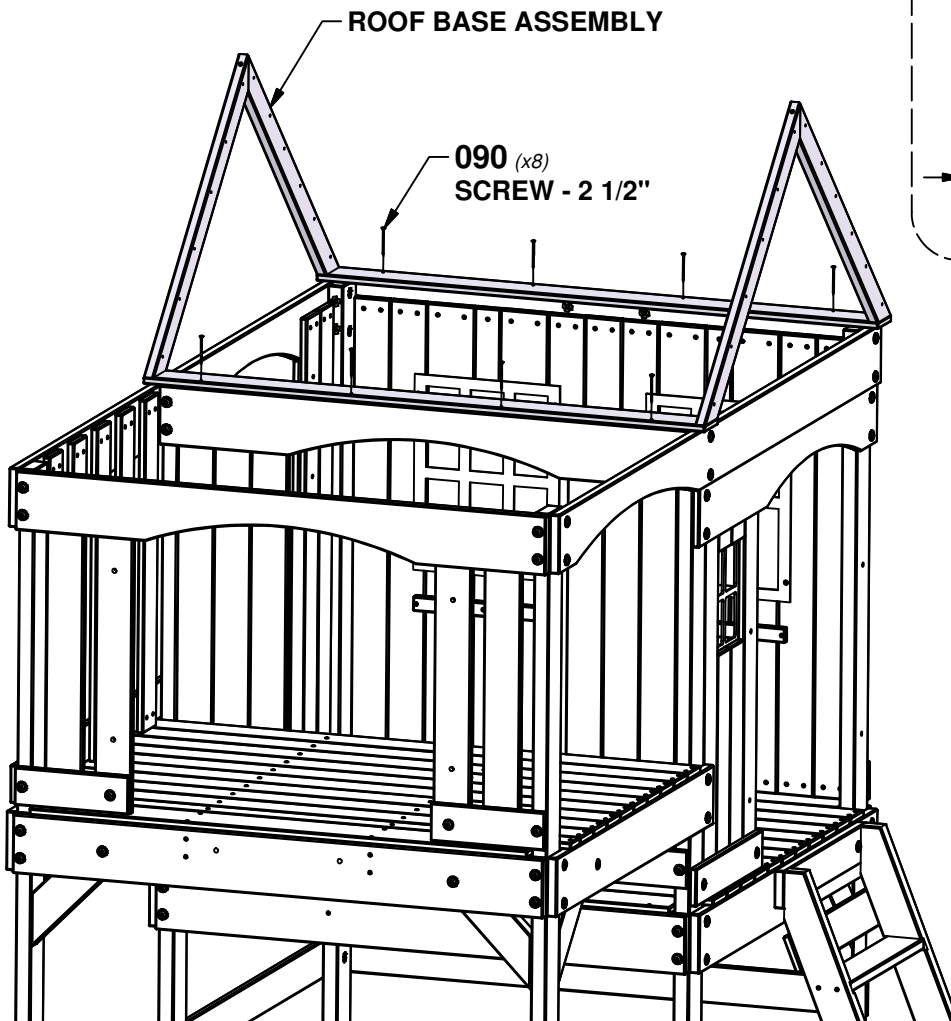
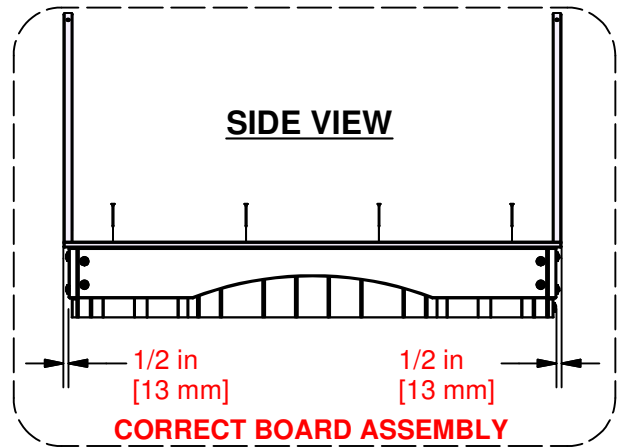
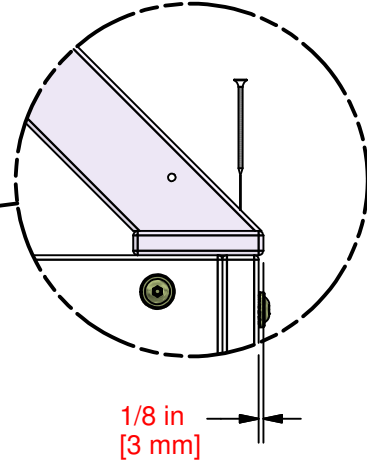
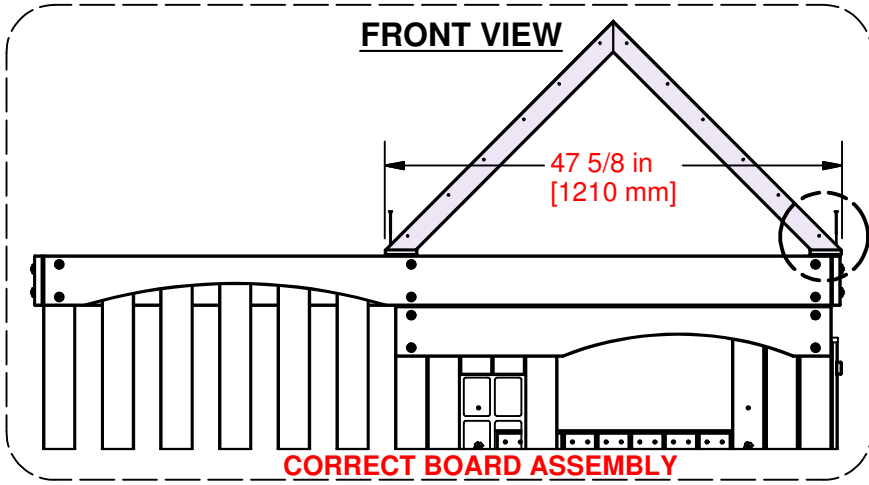

# STEP 30 - FORT ASSEMBLY

QTY	PART NUMBER	DESCRIPTION
6	H100090	SCREW PFH 8x2 1/2

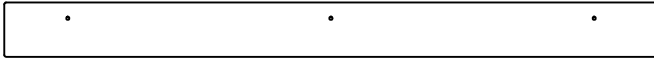

**M07** | WALL CAP - W4L16068  
 (x2) | 5/8"x3 3/8"x40 7/8" (16x86x1038)

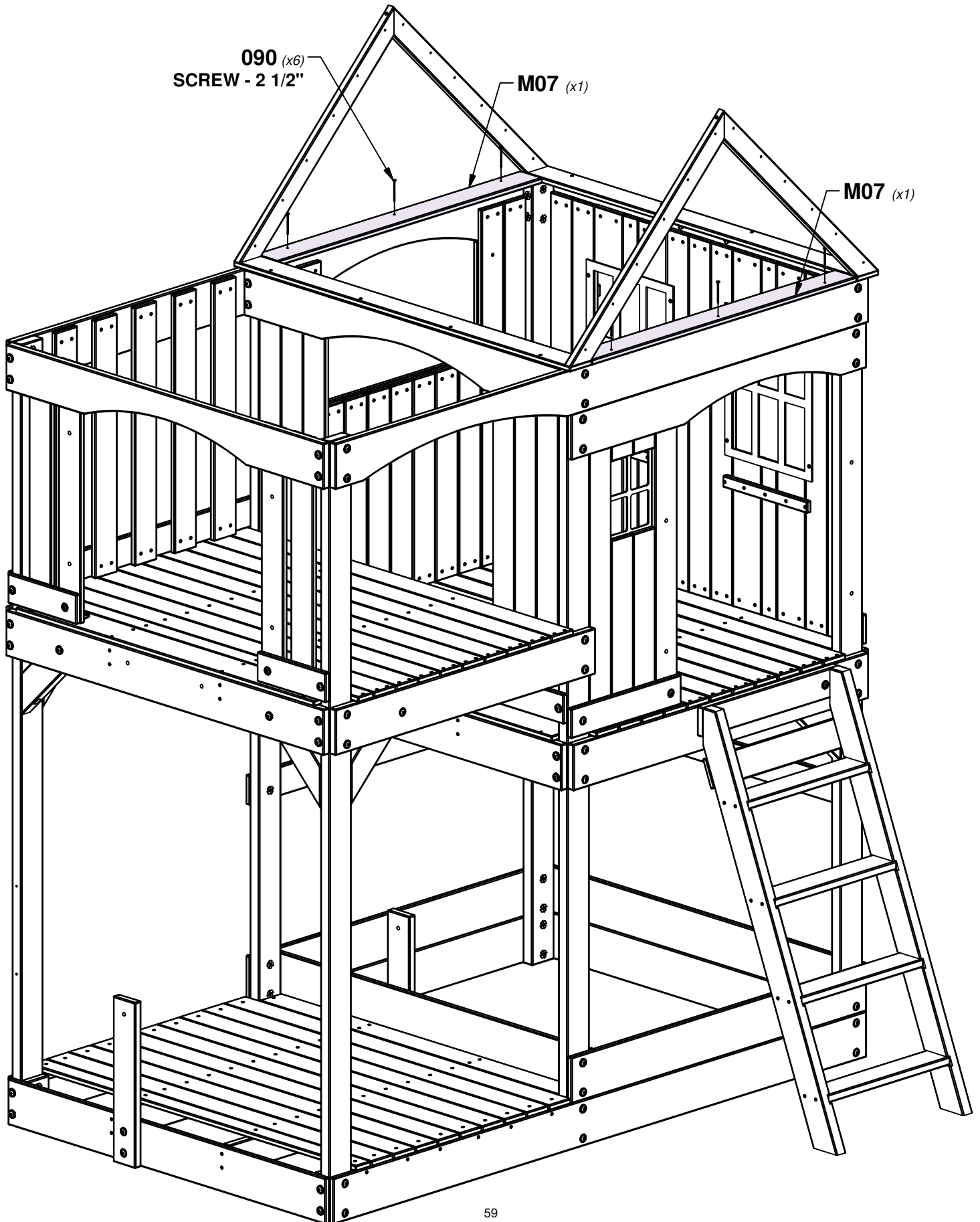

# STEP 31 - FORT ASSEMBLY

QTY	PART NUMBER	DESCRIPTION
44	H100088	SCREW PFH 8x1-1/8"

**M19** | GABLE BOARD - W4L16054  
(x4) | 5/8"x3 3/8"x15 1/4" (16x86x387)

**M22** | GABLE BOARD - W4L16058  
(x4) | 5/8"x3 3/8"x9 1/2" (16x86x241)

**N04** | GABLE BOARD - W4L16079  
(x4) | 5/8"x2 3/8"x11 7/8" (16x60x301)

**M04** | GABLE BOARD - W4L16065  
(x2) | 5/8"x3 3/8"x44" (16x86x1118)

**M20** | GABLE BOARD - W4L16056  
(x2) | 5/8"x3 3/8"x12 1/4" (16x86x310)

**M15** | GABLE BOARD - W4L16051  
(x2) | 5/8"x3 3/8"x19" (16x86x482)

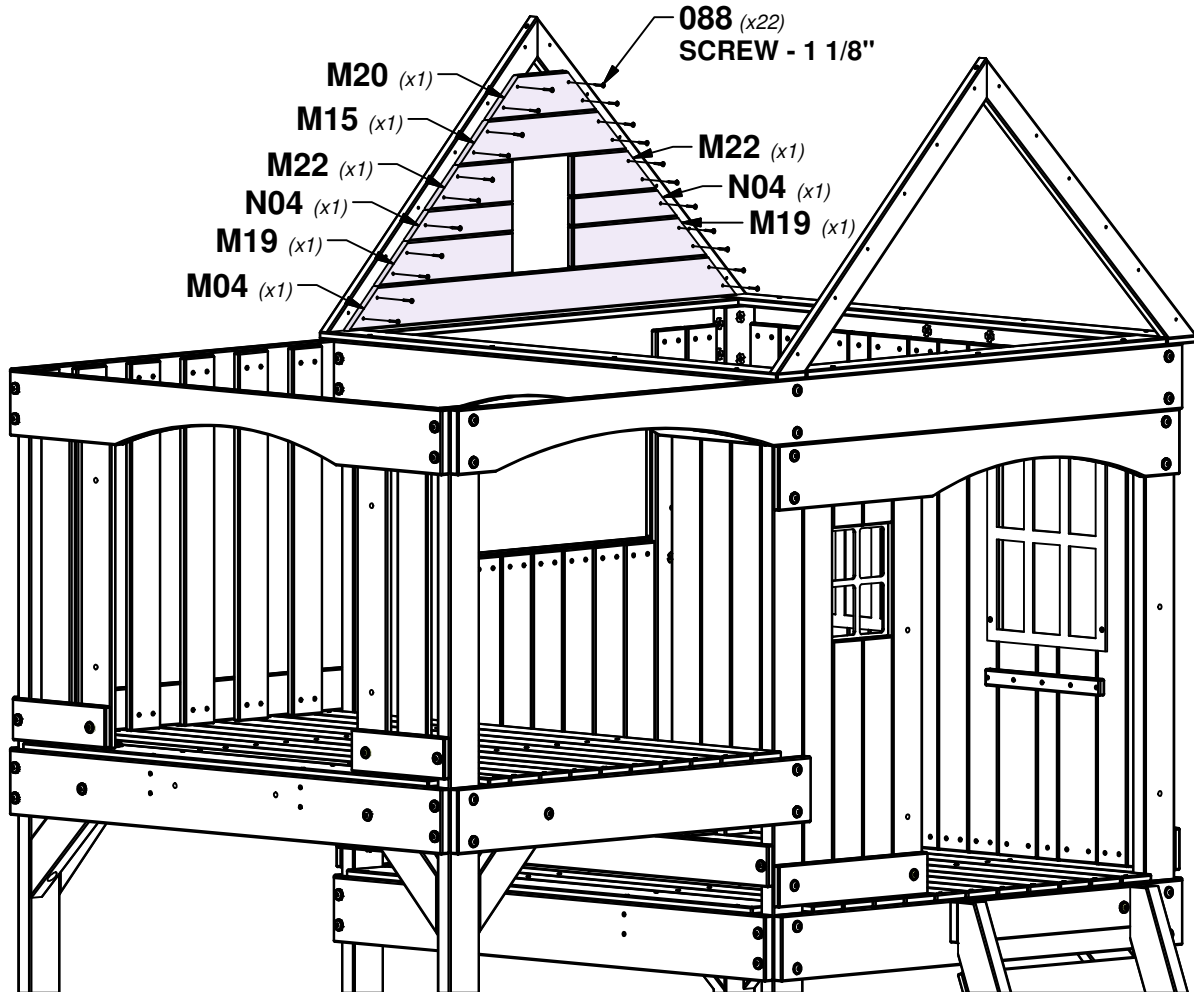
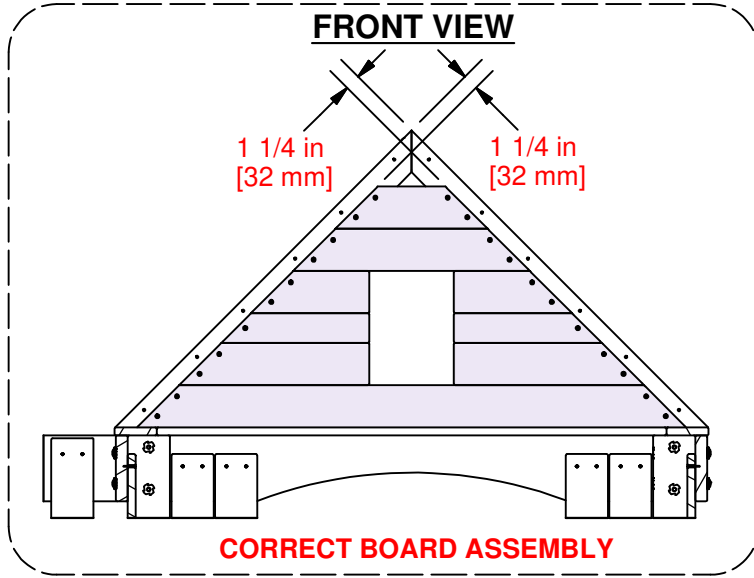

# STEP 32 - FORT ASSEMBLY

QTY	PART NUMBER	DESCRIPTION
8	H100070	SCREW PWH 8x3/4
20	H100088	SCREW PFH 8x1-1/8"

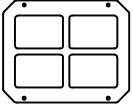

A100146 WINDOW  
(x2) 216x267 GREEN

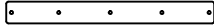

O01 WALL SUPPORT - W4L16081  
(x4) 5/8"x1 3/8"x13" (16x34x330)

## FRONT VIEW

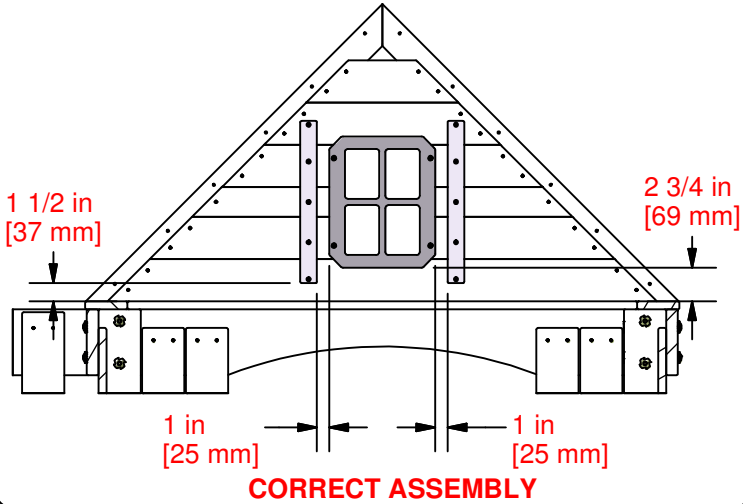

**REPEAT STEPS 31 & 32 ON THE OPPOSITE SIDE.**

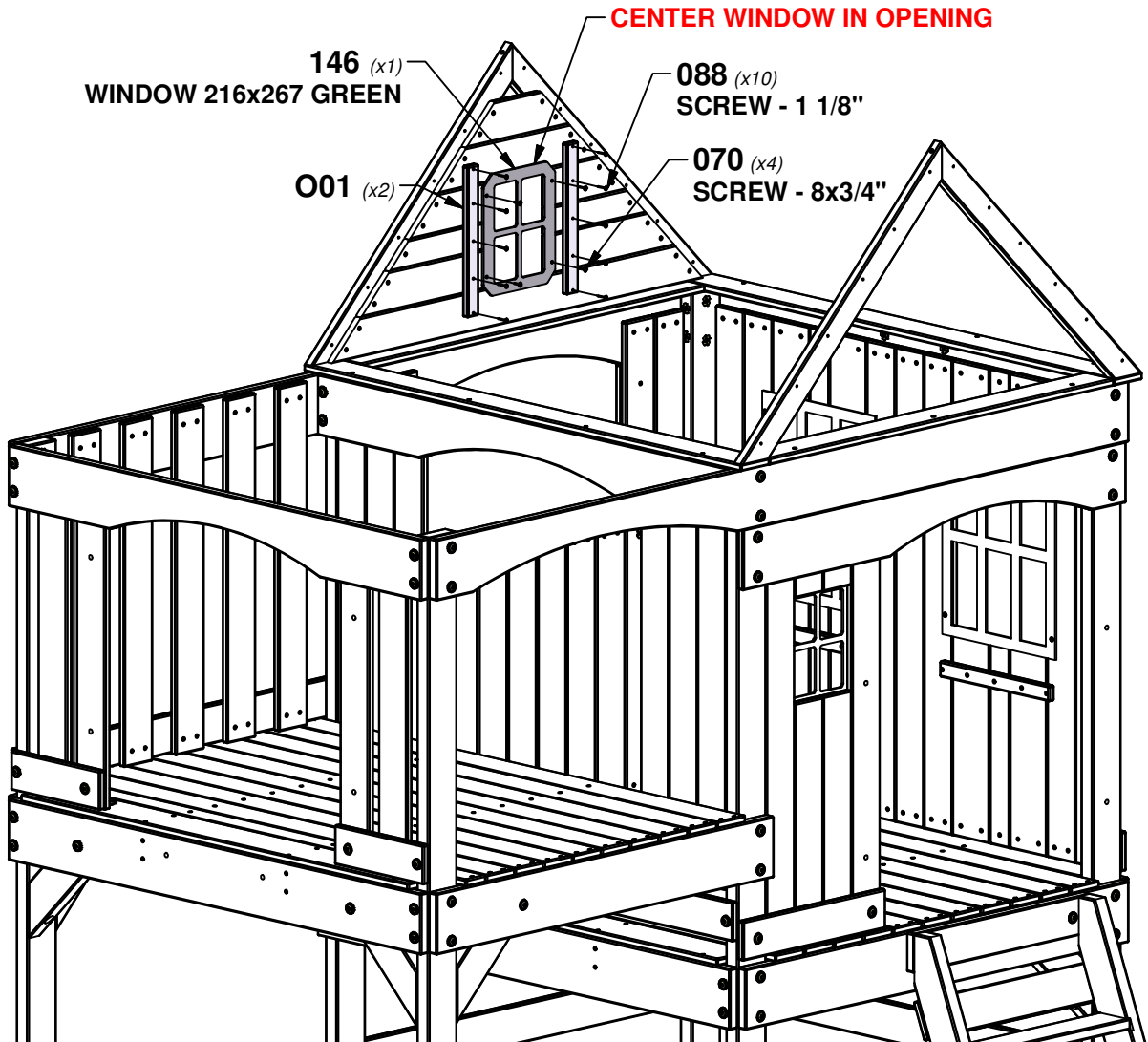

# STEP 33 - FORT ASSEMBLY

QTY	PART NUMBER	DESCRIPTION
24	H100089	SCREW PFH 8x1-3/4"

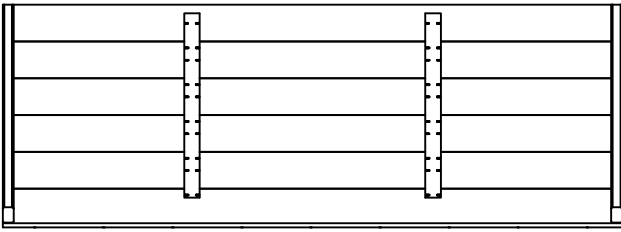

**RP1** | ROOF PANEL - W2A03279  
(x2) | 1 3/4"x19 1/4"x53 3/4" (45x490x1366)

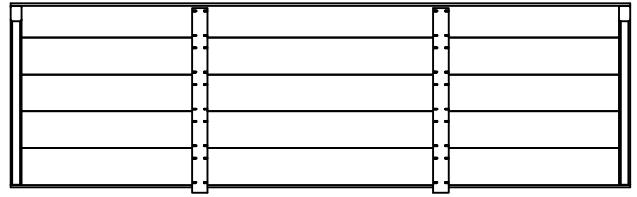

**RP2** | ROOF PANEL - W2A03280  
(x2) | 1 3/4"x16 1/4"x53 3/4" (45x417x1366)

**REPEAT THIS STEP FOR THE OPPOSITE SIDE.**

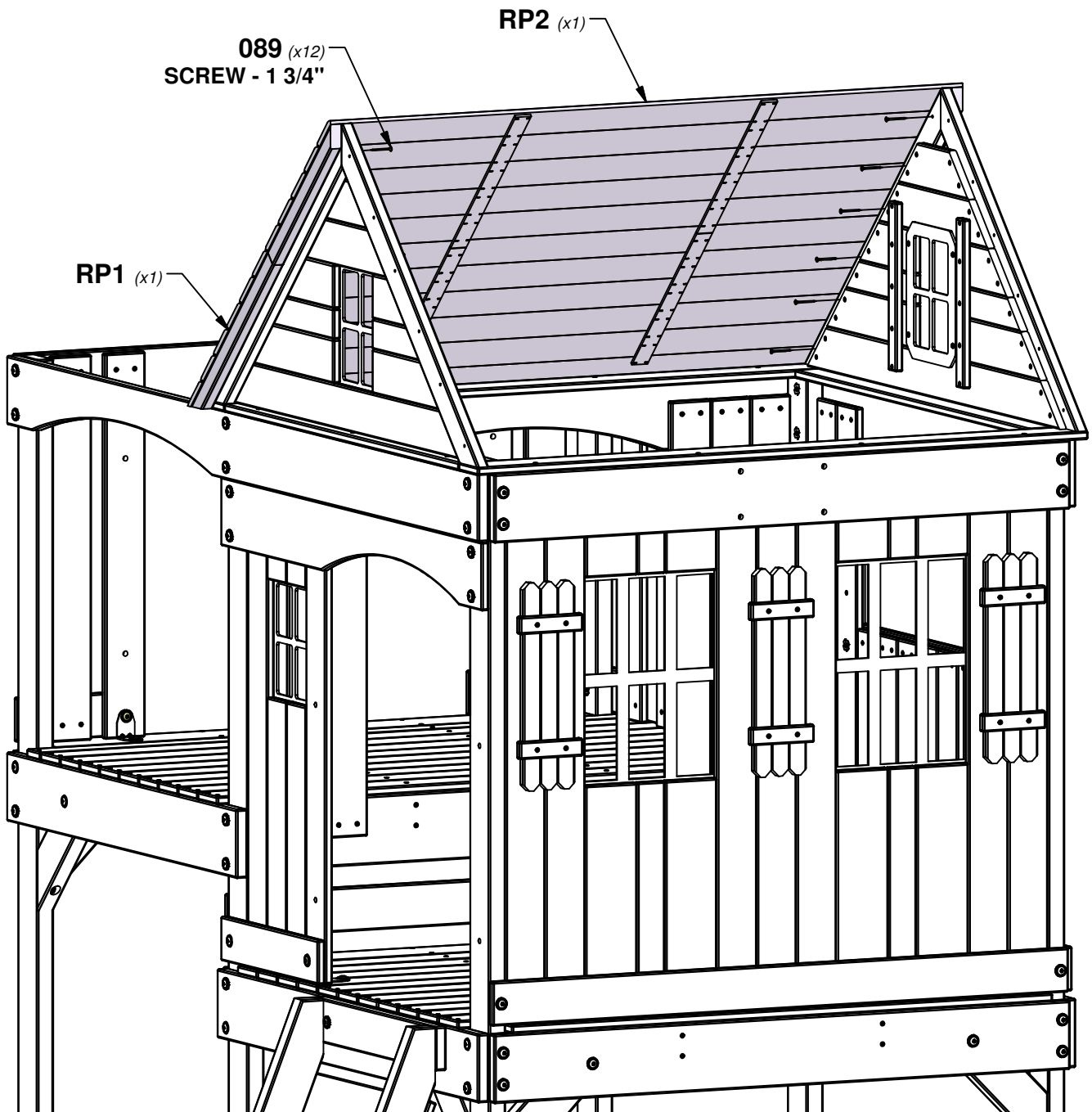

# STEP 34 - FORT ASSEMBLY

QTY	PART NUMBER	DESCRIPTION
4	H100088	SCREW PFH 8x1-1/8"

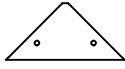

**N02** | MENDING PLATE - W4L16077  
(x2) | 5/8"x2 3/8"x5" (16x60x126)

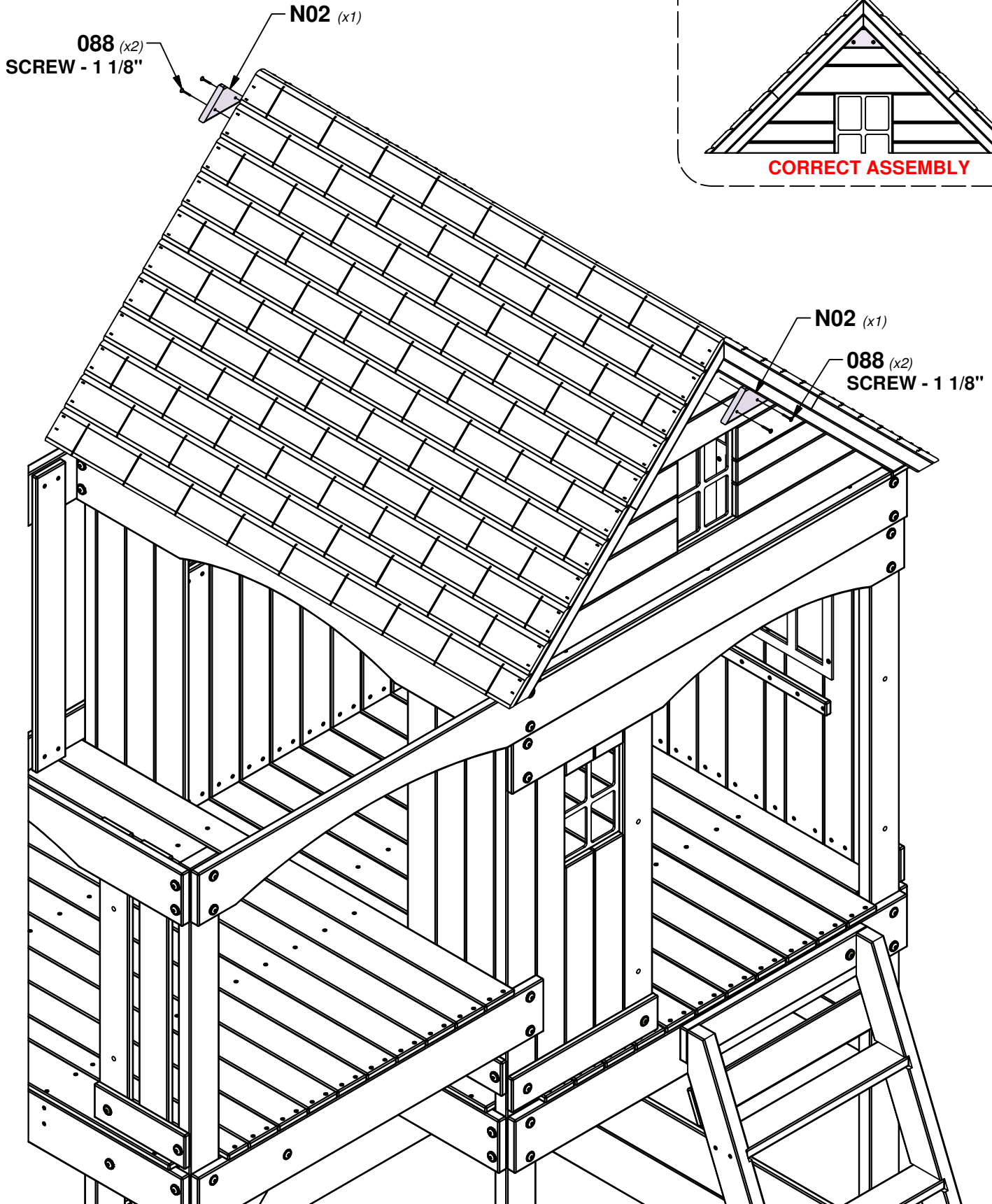

# STEP 35 - FORT ASSEMBLY

QTY	PART NUMBER	DESCRIPTION
2	H100010	BOLT WH 5/16x1 1/2
8	H100074	T-NUT 5/16
6	H100115	BOLT WH 5/16x1/2



**A100118** | **HAND GRIP**  
*(x4)* | **METAL GREEN**  
 381 c/c

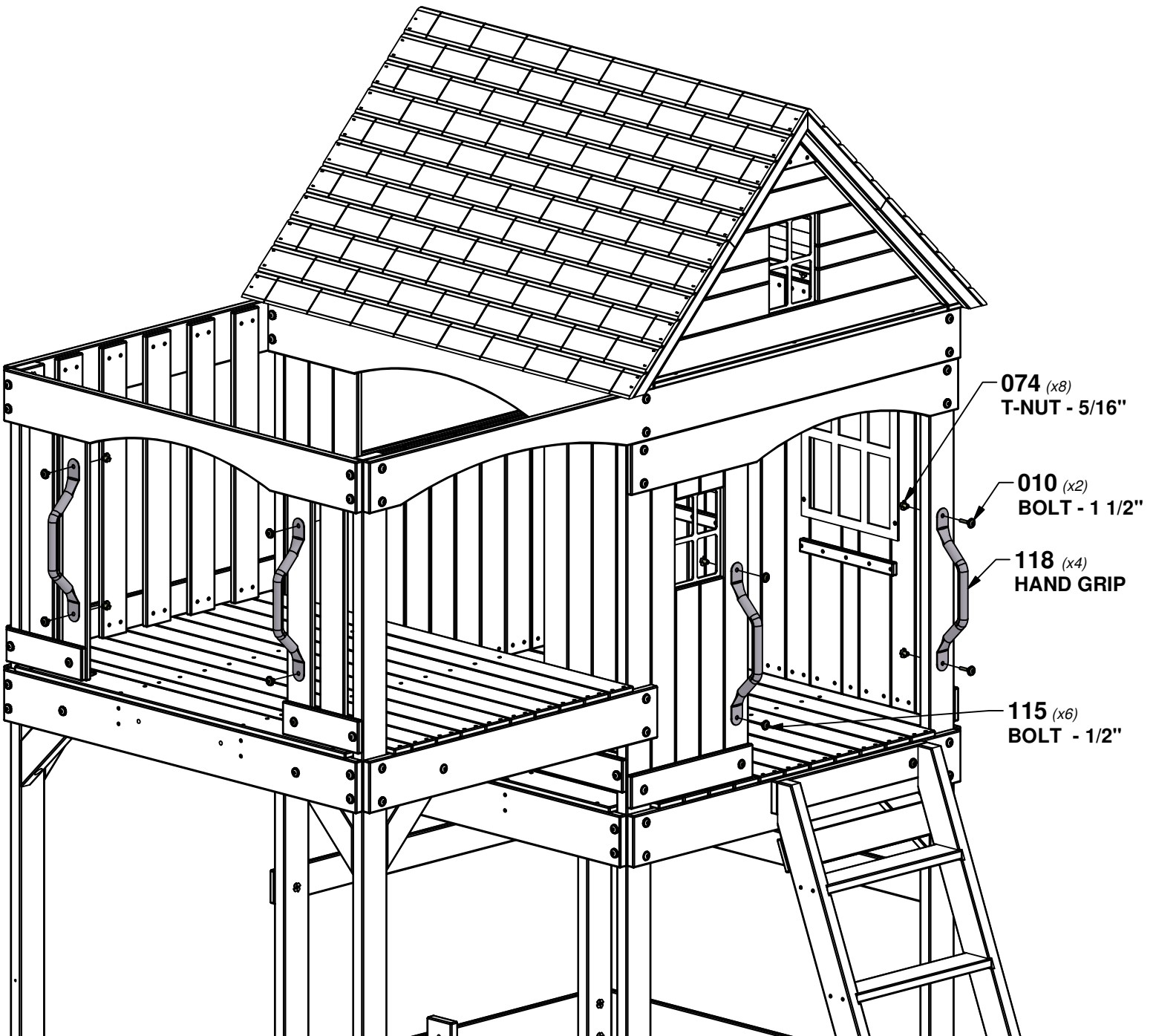

# STEP 36 - FORT ASSEMBLY

QTY	PART NUMBER	DESCRIPTION
8	H100086	SCREW PFH 8x1-1/2"

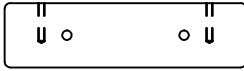

**T01** SEAT SUPPORT - W4L16086  
(x4) 1"x1 3/8"x5" (24x34x128)

## PLACEMENT VIEWS

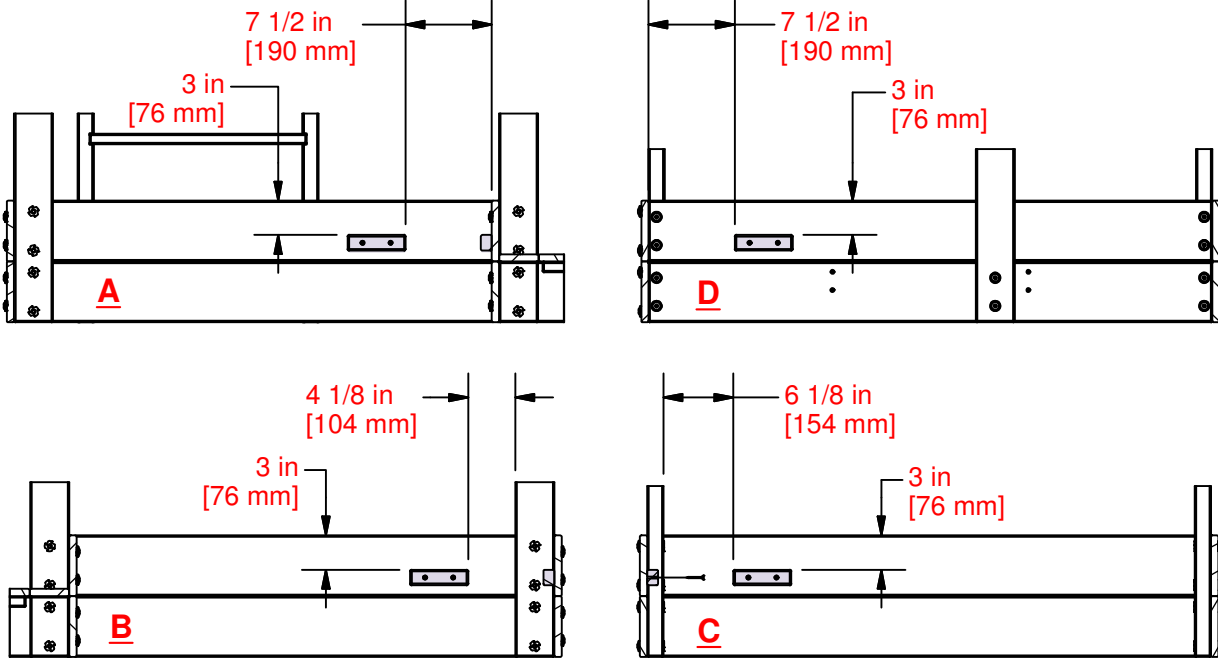

SEE LOCATIONS BELOW (A, B, C, & D)

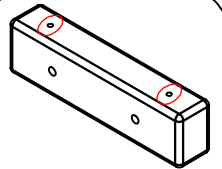

INSTALL T01  
WITH SMALL  
PILOT HOLES  
UPWARD

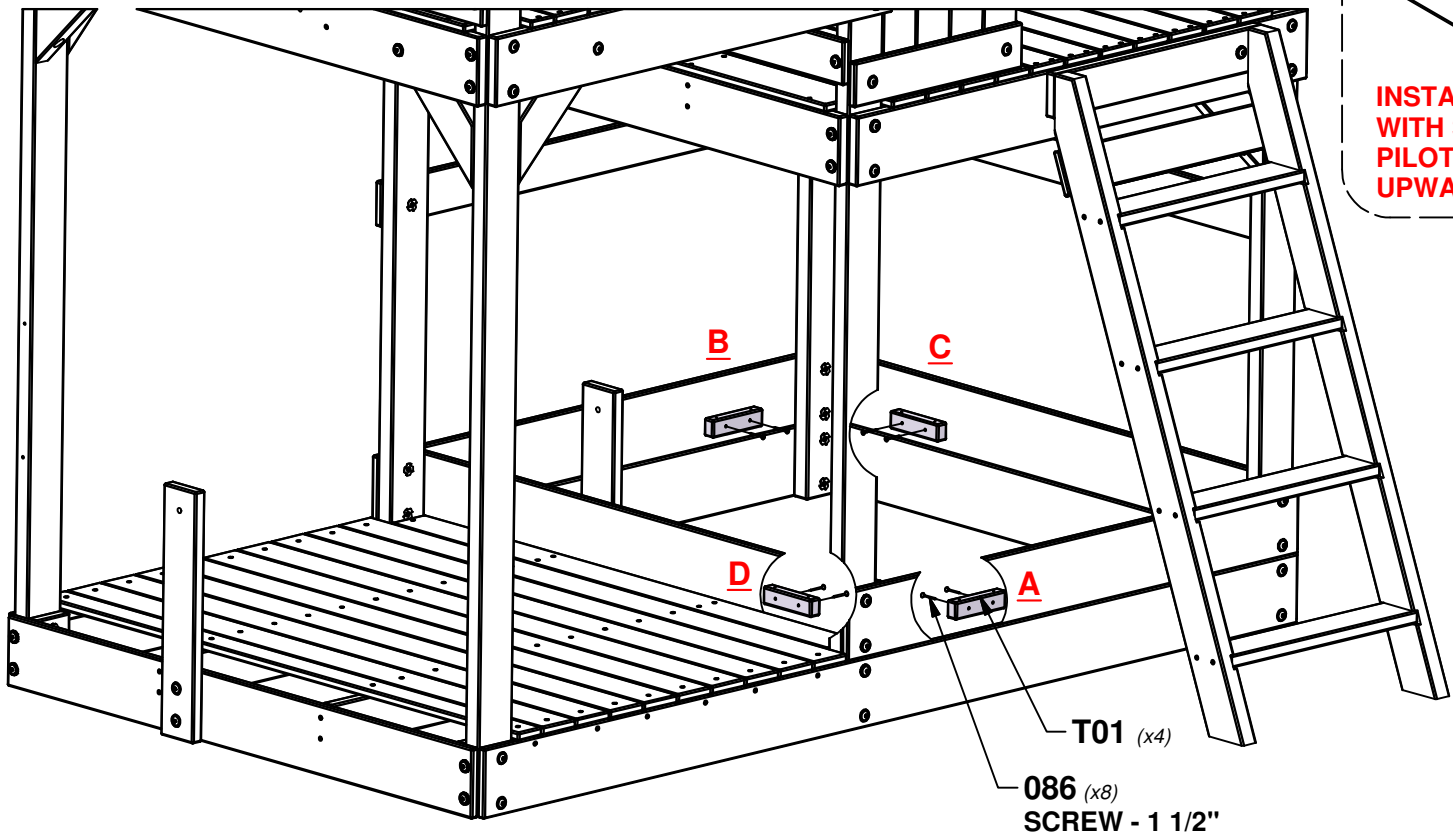

# STEP 37 - FORT ASSEMBLY

QTY	PART NUMBER	DESCRIPTION
8	H100089	SCREW PFH 8x1-3/4"



**G13** SAND BOX SEAT - W4L16013  
(x2) 1"x5 1/4"x17 3/4" (24x134x450)

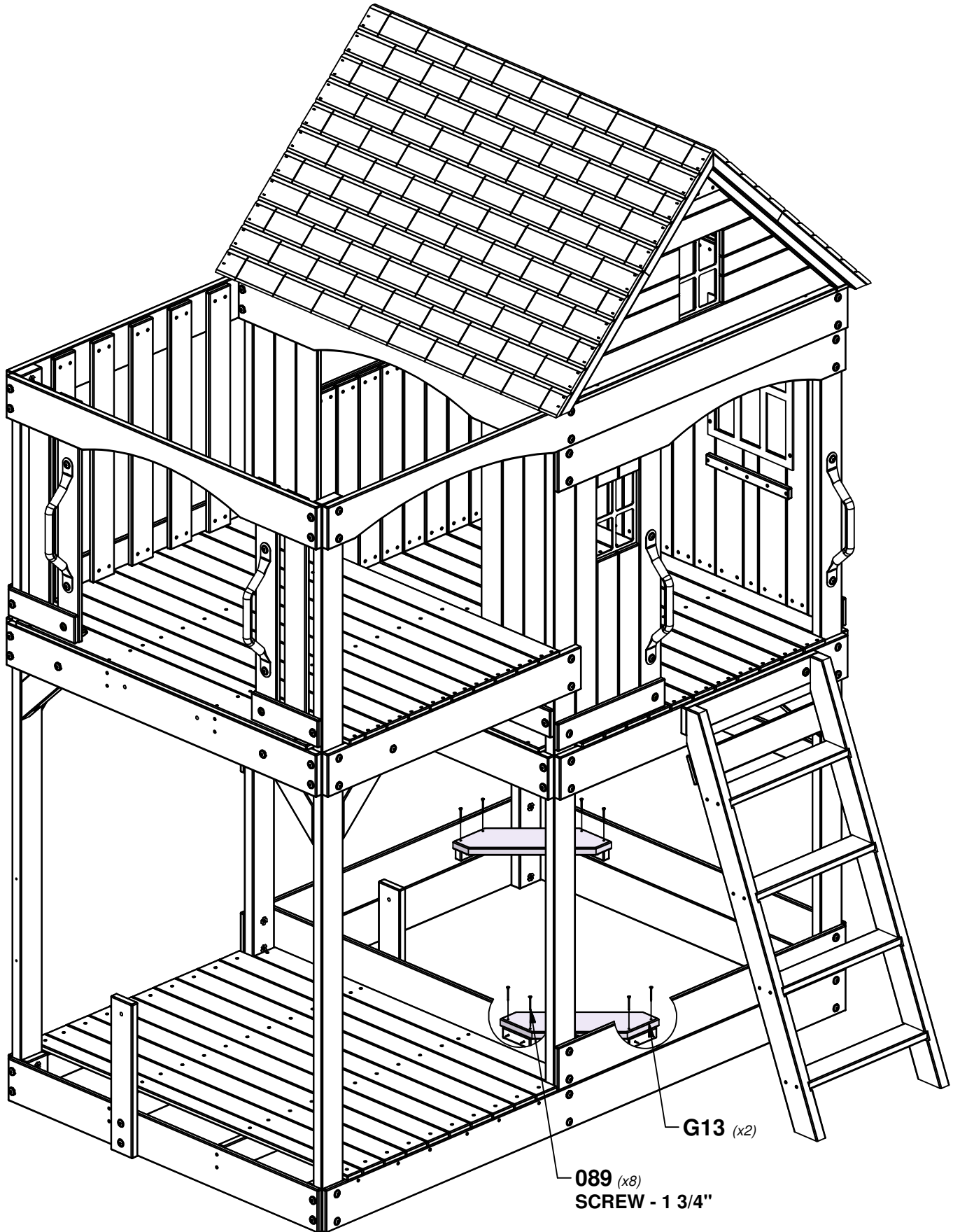

# STEP 38 - FORT ASSEMBLY

QTY	PART NUMBER	DESCRIPTION
24	H100088	SCREW PFH 8x1-1/8"



**M27** | BOTTOM WALL BOARD - W4L16062  
 (x6) | 5/8" x 3 3/8" x 21 3/8" (16x86x544)

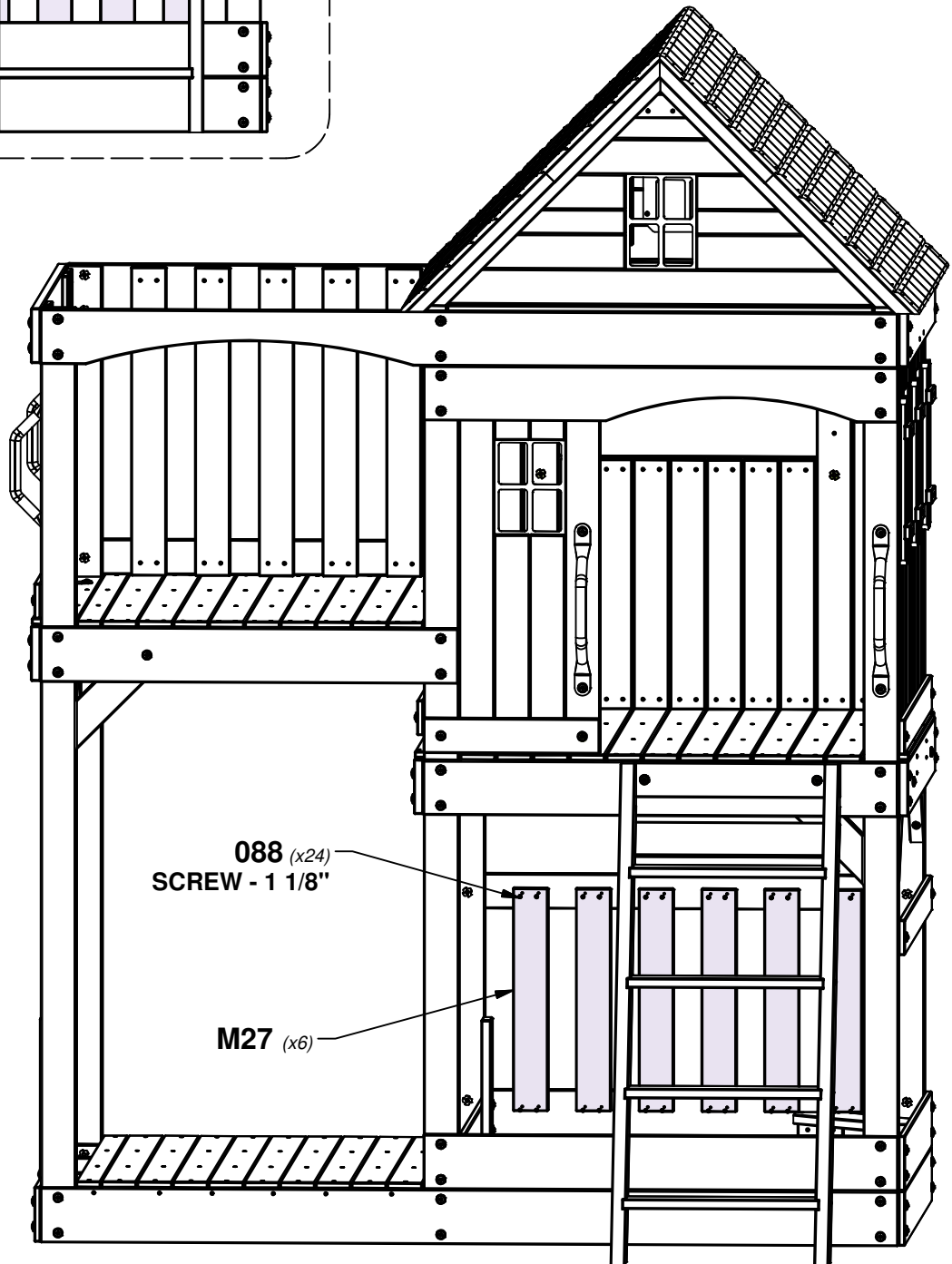
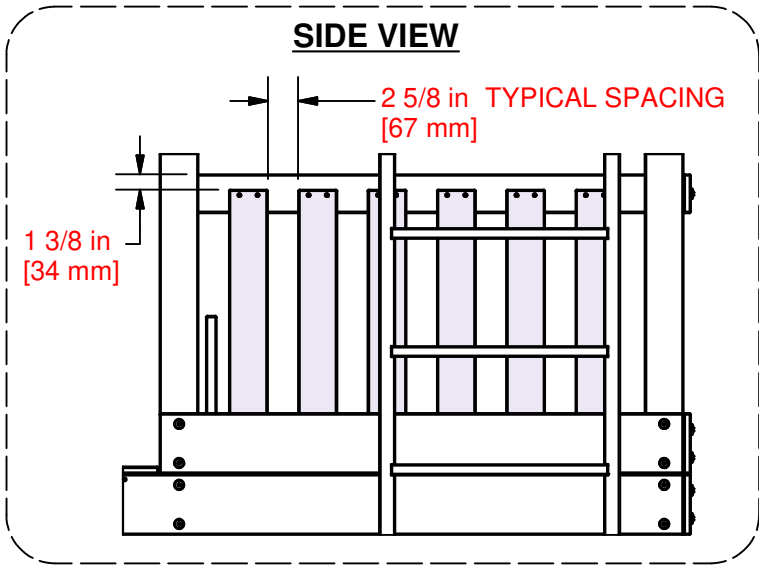

# STEP 39 - FORT ASSEMBLY

QTY	PART NUMBER	DESCRIPTION
28	H100088	SCREW PFH 8x1-1/8"

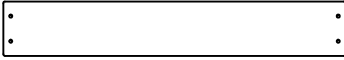

**M27** | BOTTOM WALL BOARD - W4L16062  
(x7) 5/8"x3 3/8"x21 3/8" (16x86x544)

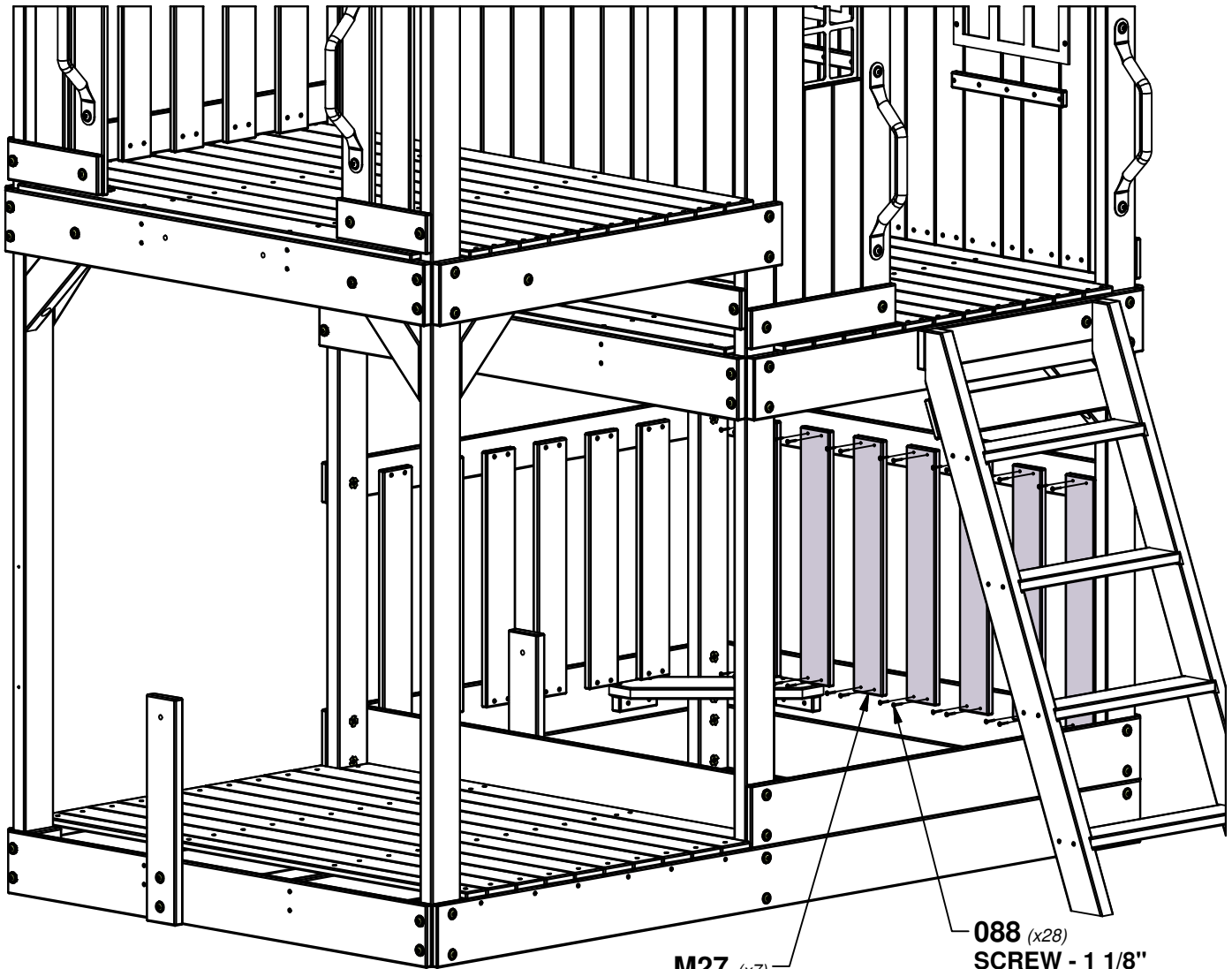
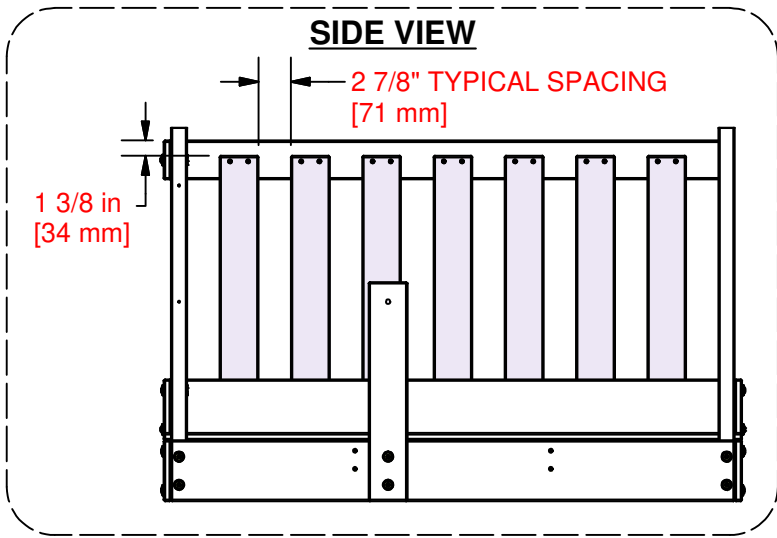

# STEP 40 - FORT ASSEMBLY

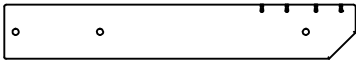

**M14** | PICNIC SEAT SUPPORT - W4L16050  
 (x2) | 5/8"x3 3/8"x22" (16x86x558)

QTY	PART NUMBER	DESCRIPTION
2	H100010	BOLT WH 5/16x1 1/2
2	H100028	LAG SCREW WH 5/16x2 1/2
4	H100030	WASHER LOCK EXT 8x19
2	H100074	T-NUT 5/16

**REMOVE PICKET  
 UNTIL AFTER  
 STEP 41**

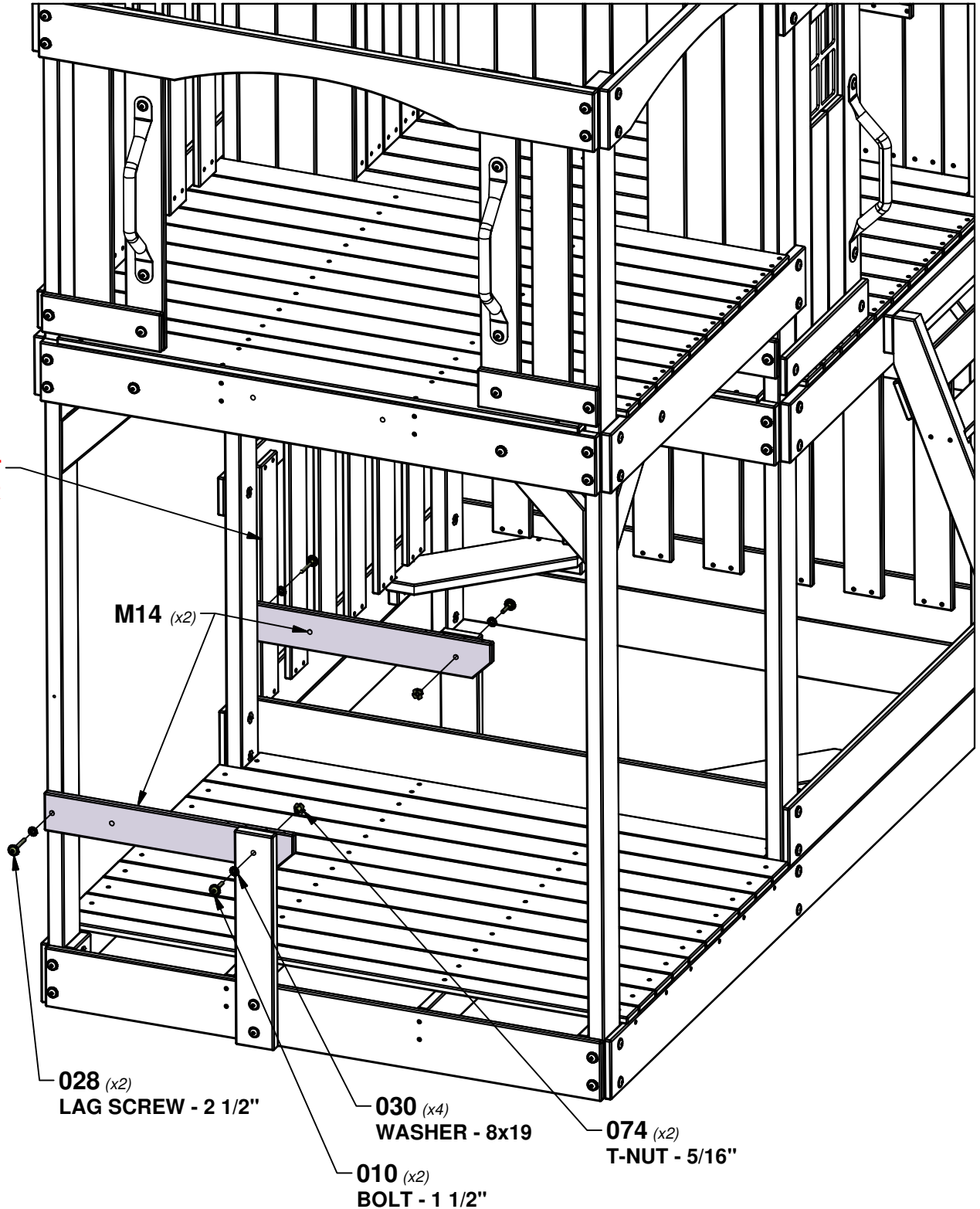

# STEP 41 - FORT ASSEMBLY

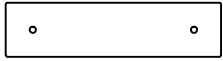

**M25** TABLE SUPPORT - W4L16037  
(x2) 5/8"x3 3/8"x13 1/2" (16x86x342)

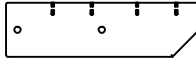

**H08** TABLE SUPPORT - W4L16031  
(x2) 1"x3 3/8"x12" (24x86x306)

QTY	PART NUMBER	DESCRIPTION
2	H100009	BOLT WH 5/16x1 1/4
2	H100010	BOLT WH 5/16x1 1/2
2	H100028	LAG SCREW WH 5/16x2 1/2
6	H100030	WASHER LOCK EXT 8x19
4	H100074	T-NUT 5/16

**TIP:**  
INSTALL T-NUTS IN WOOD FIRST

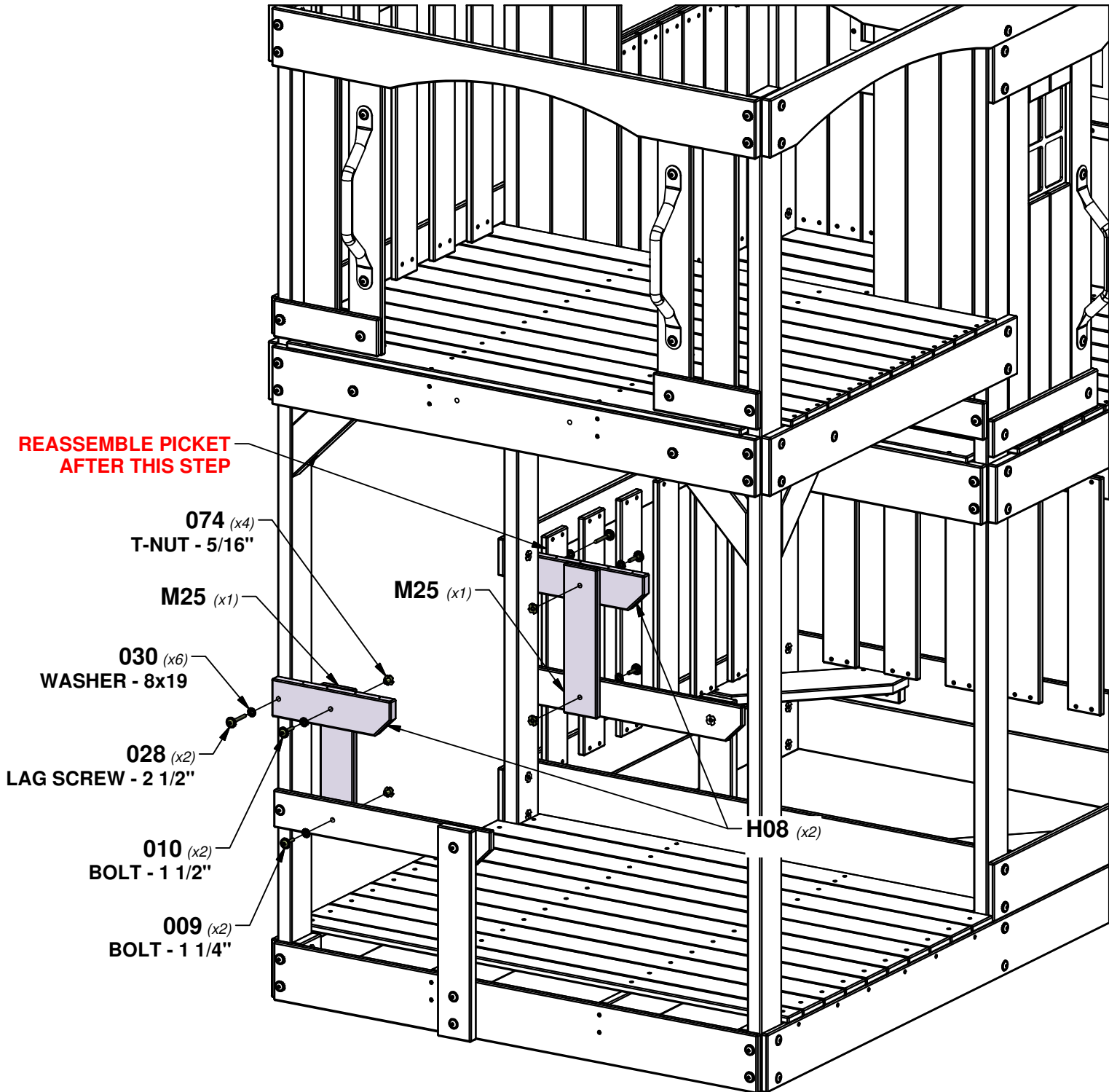

# STEP 42 - FORT ASSEMBLY

QTY	PART NUMBER	DESCRIPTION
1	H100088	SCREW PFH 8x1-1/8"
1	H100089	SCREW PFH 8x1-3/4"

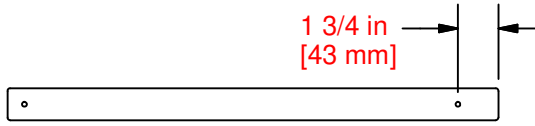

**O03** SAFETY RAIL - W4L16083  
(x1) 5/8"x1 3/8"x20 1/2" (16x34x520)

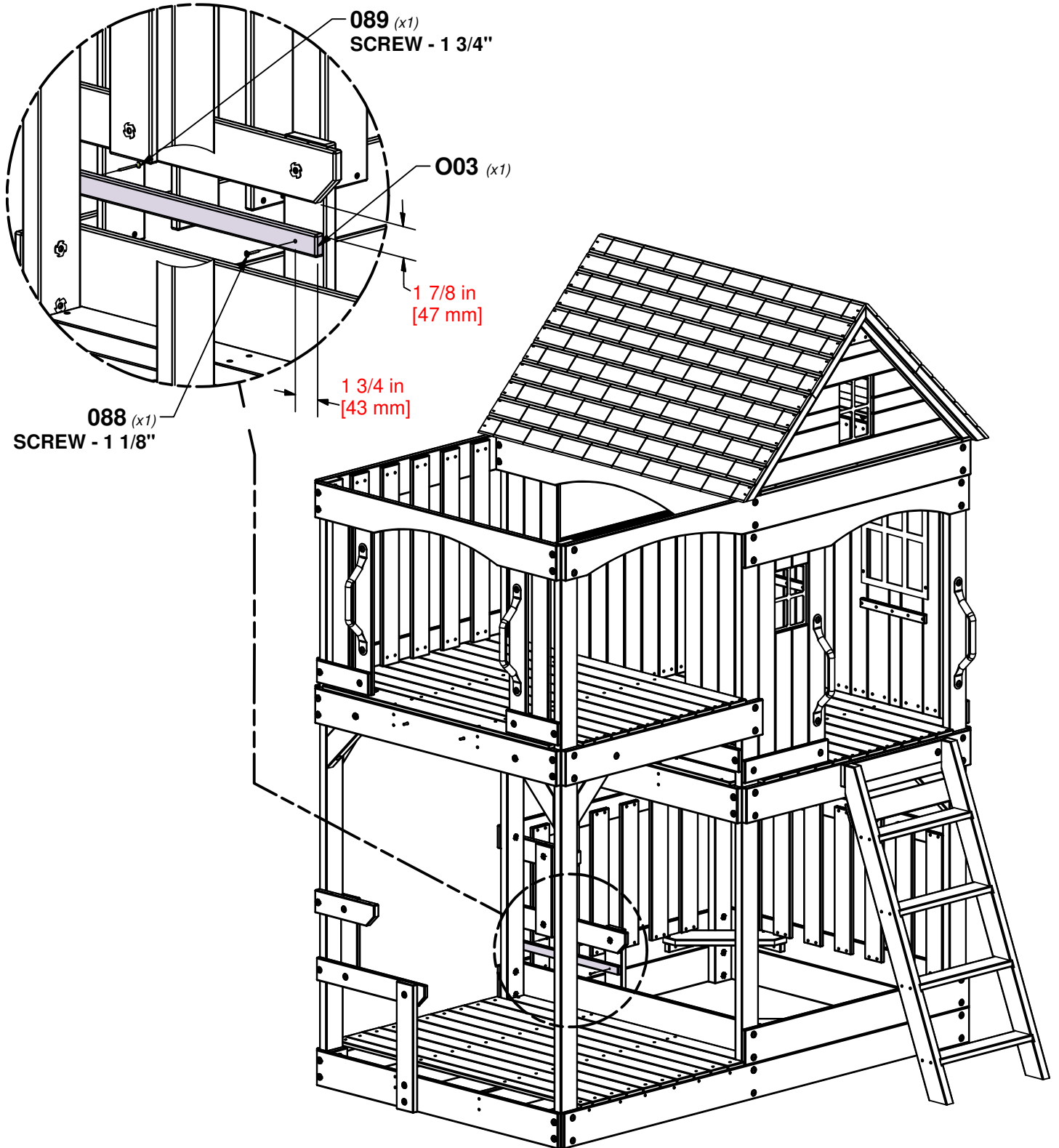

# STEP 43 - FORT ASSEMBLY

QTY	PART NUMBER	DESCRIPTION
16	H100089	SCREW PFH 8x1-3/4"



**H02** | PICNIC TABLE SEAT - W4L16025  
(x2) | 1"x3 3/8"x41 3/8" (24x86x1050)



**G11** | PICNIC TABLE TOP - W4L16011  
(x2) | 5/8"x5 1/4"x42" (16x134x1066)

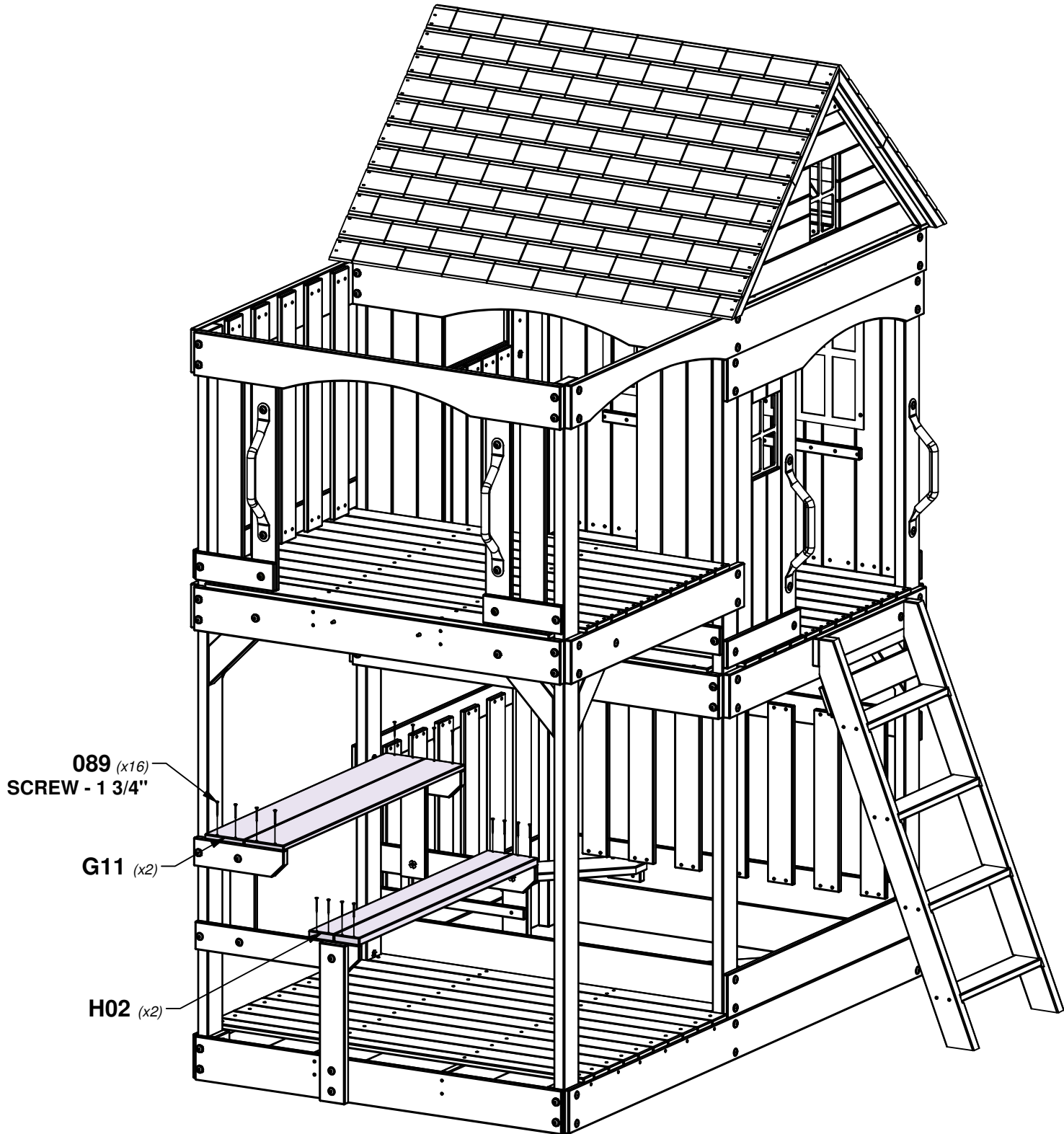

# STEP 44 - FORT ASSEMBLY

QTY	PART NUMBER	DESCRIPTION
2	H100011	BOLT WH 5/16x1 3/4
2	H100030	WASHER LOCK EXT 8x19

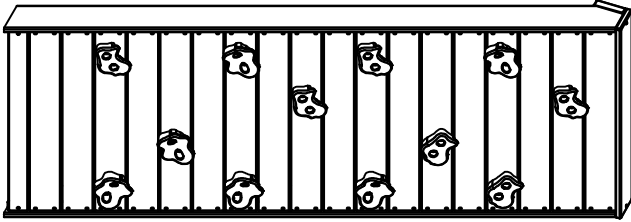

ROCKWALL ASSEMBLY

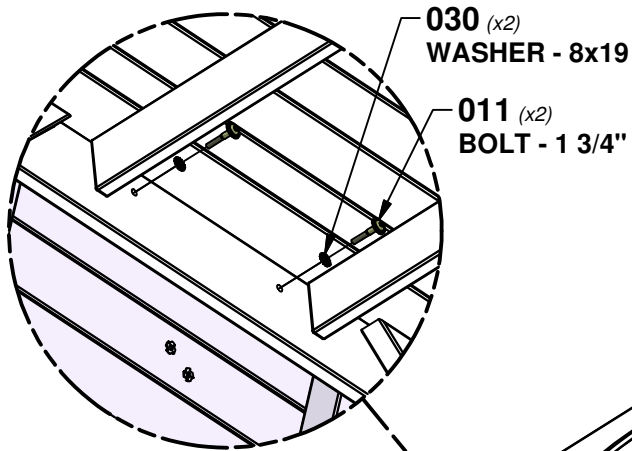

030 (x2)  
WASHER - 8x19

011 (x2)  
BOLT - 1 3/4"

ROCKWALL ASSEMBLY

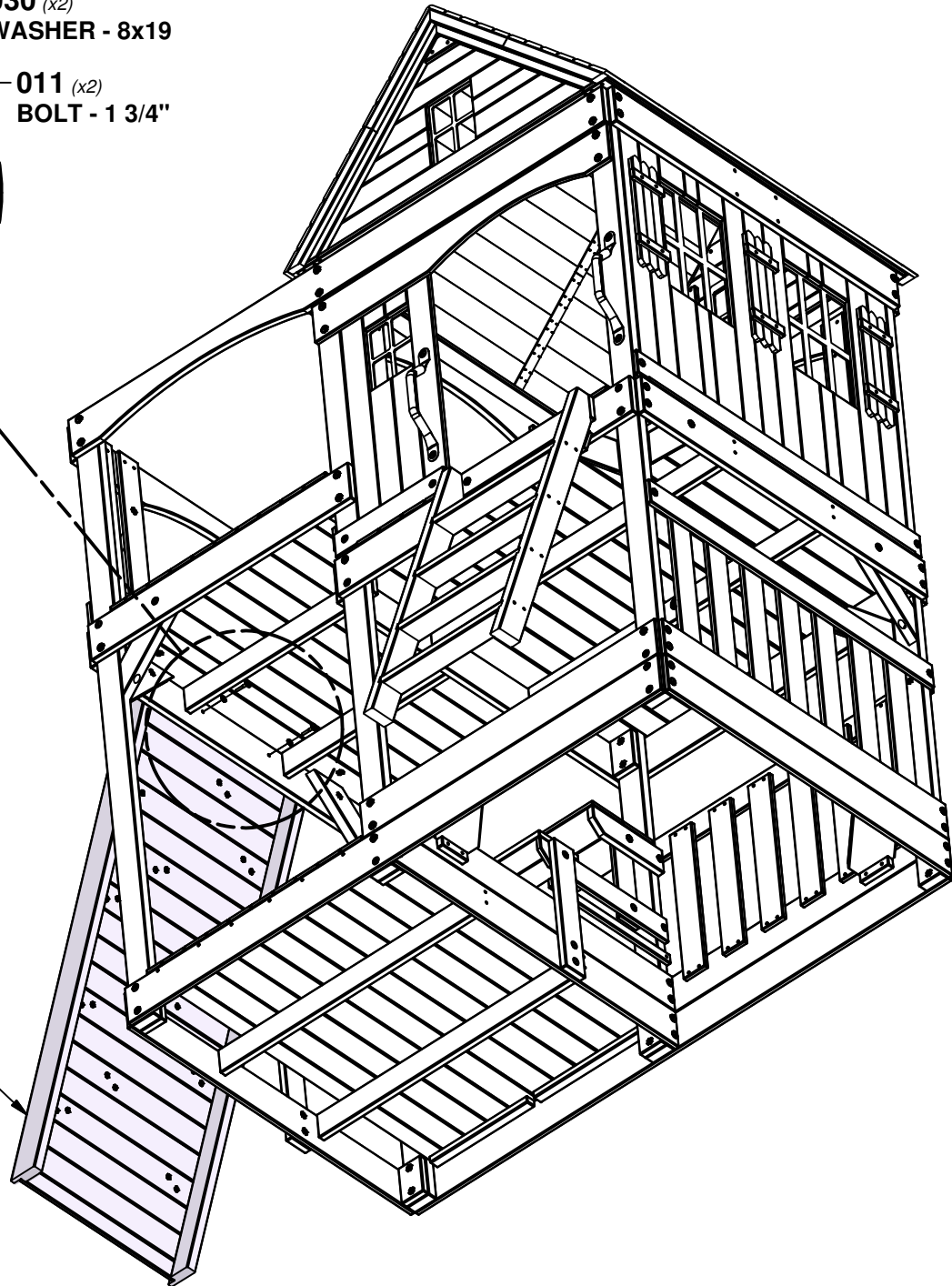

# STEP 45 - FORT ASSEMBLY

QTY	PART NUMBER	DESCRIPTION
4	H100042	BOLT HEX 5/16x1 1/4
4	H100095	WASHER SPLIT 5/16
4	H100105	WASHER FLAT 8x27

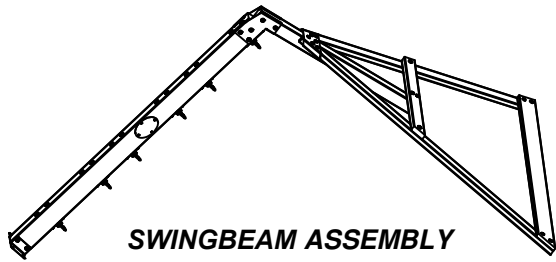

- 042 (x4)**  
BOLT HEX - 1 1/4"
- 095 (x4)**  
WASHER - 5/16"
- 105 (x4)**  
WASHER - 8x27

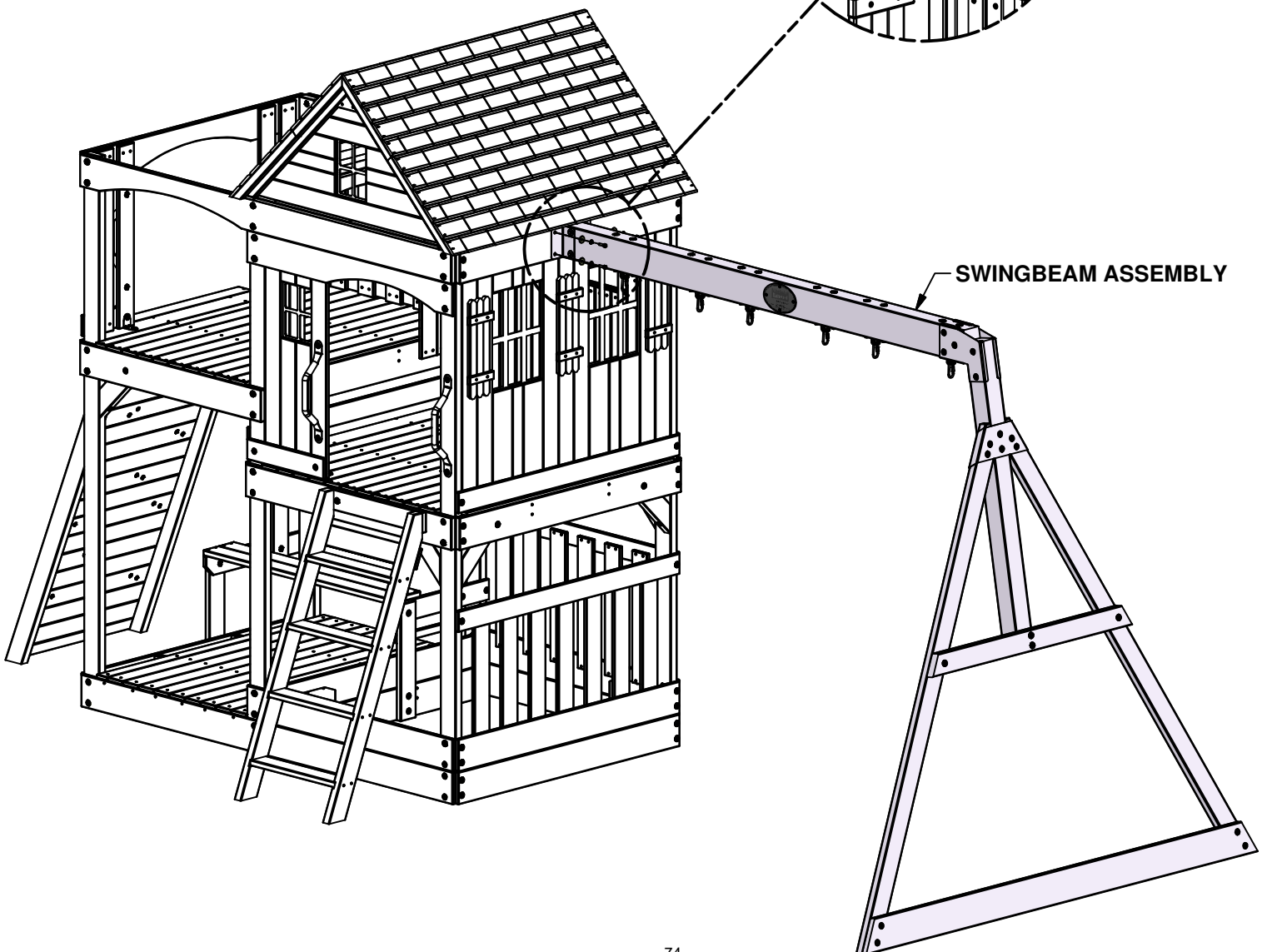
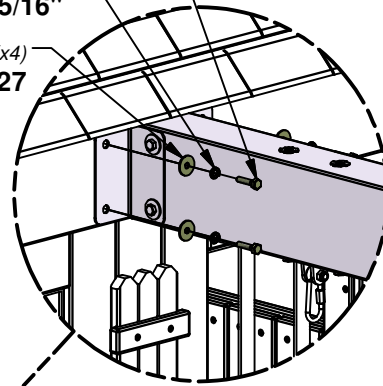

# STEP 46 - FORT ASSEMBLY

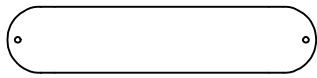

A100027 | SWING SEAT GREEN 26"  
(x2)

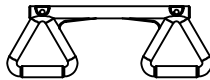

A6P00034 | TRAPEZE YELLOW  
(x1)

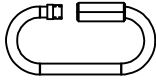

A100069 | QUICK LINK  
(x6)



A100183 | ROPE-CHAIN GREEN 57"  
(x4)

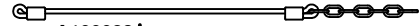

A100083 | ROPE-CHAIN GREEN 33"  
(x2)

**NOTE:**  
WHEN HANGING YOUR SWINGS, IT IS  
REQUIRED TO ONLY TRIM AROUND THE  
SPECIFIC CHAIN LOOP THAT ALLOWS THE  
BOTTOM OF THE SWING SEAT, (WHEN  
SITTING ON IT) TO BE NO LOWER THAN  
(35CM) 13 7/8 INCHES FROM THE GROUND.

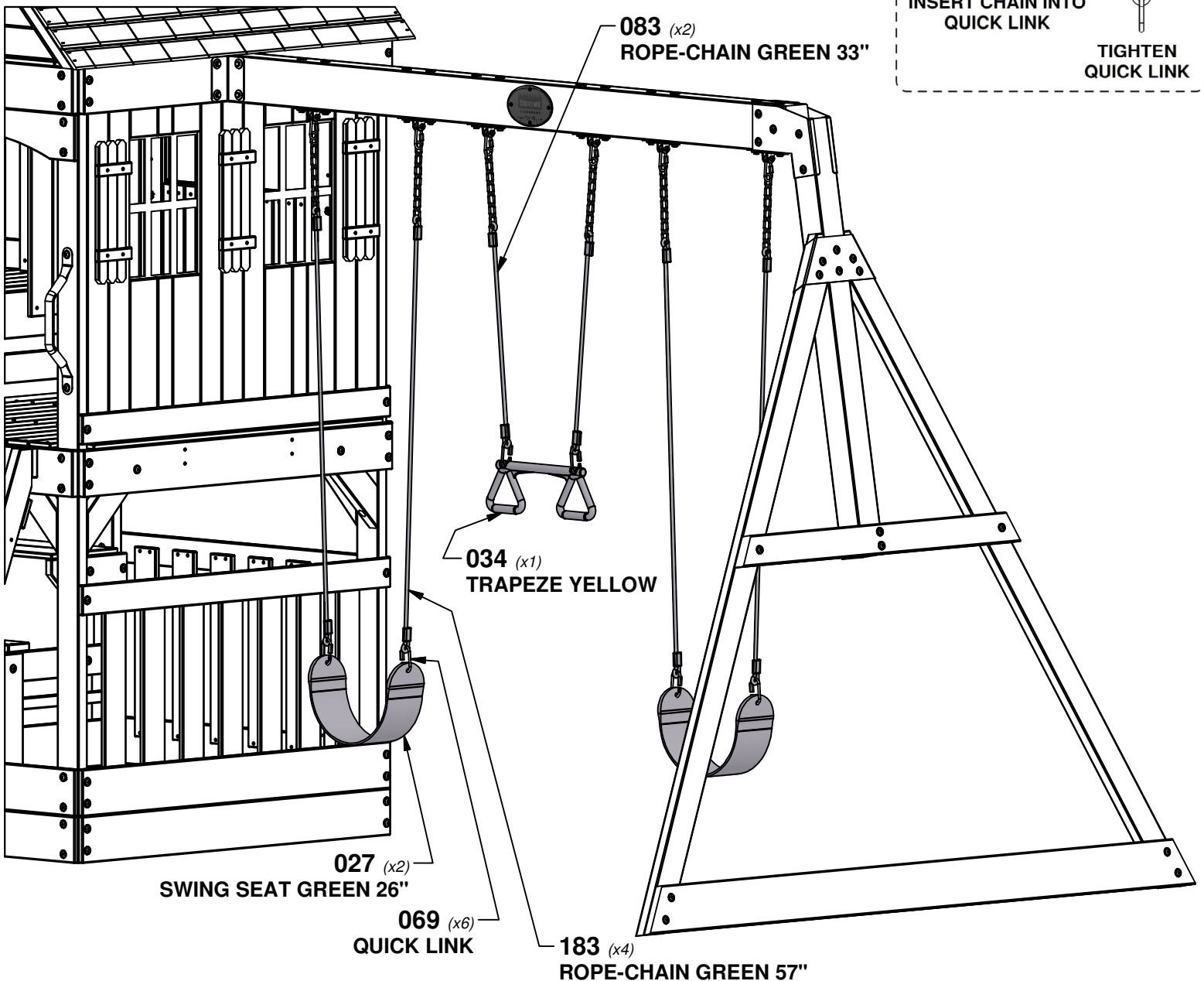
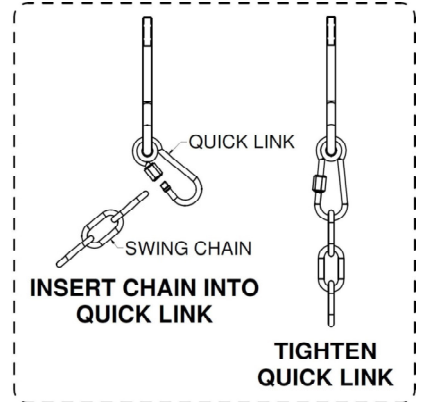

# STEP 1 - SLIDE

QTY	PART NUMBER	DESCRIPTION
3	H100074	T-NUT 5/16
3	H100115	BOLT WH 5/16x1/2



**A100035**  
(x1) | **SLIDE BED 10' LIGHT GREEN**

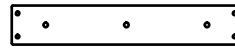

**M70**  
(x1) | **SLIDE SUPPORT BOARD - W100935**  
(5/8"x3 3/8"x19 7/8" (16x86x505))

**NOTE:**

TAKE NOTE OF SLIDE BED SURFACE FINISH, THE DULL SIDE WILL BE TOWARDS THE GROUND. PLACE SLIDE BRACE CENTERED ON THE BOTTOM (DULL SIDE) AND 1/2" FROM THE EDGE. USE **M70** BOARD AS A TEMPLATE FOR DRILLING BOTTOM HOLE PATTERN IN SLIDE BED. USE A 5/16" DRILL BIT.

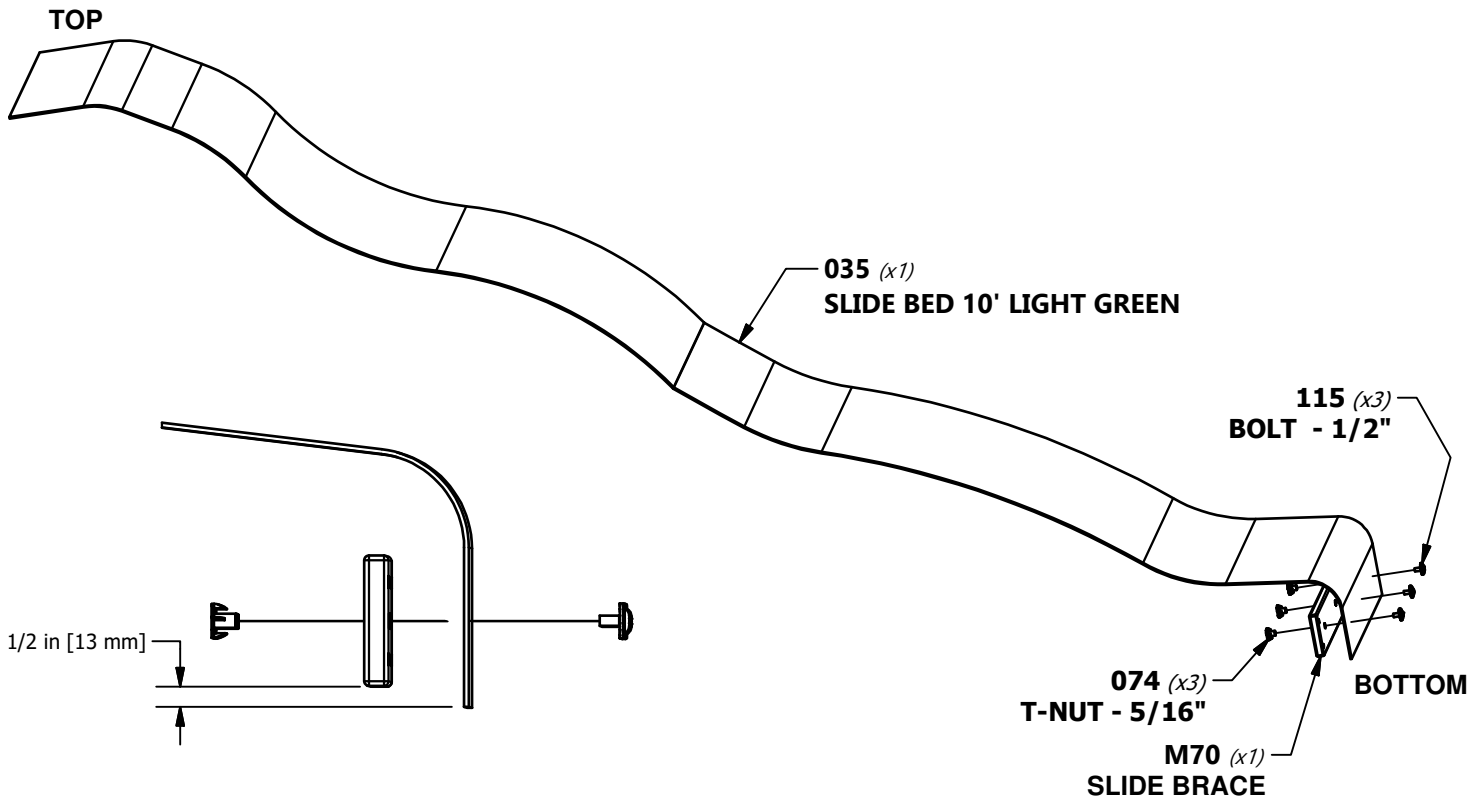

**TIP:**

PRE-BENDING THE ENDS WILL EASE ASSEMBLY. PLACING THE SLIDE BED OUT IN THE SUN MAKES IT EASIER TO BEND.

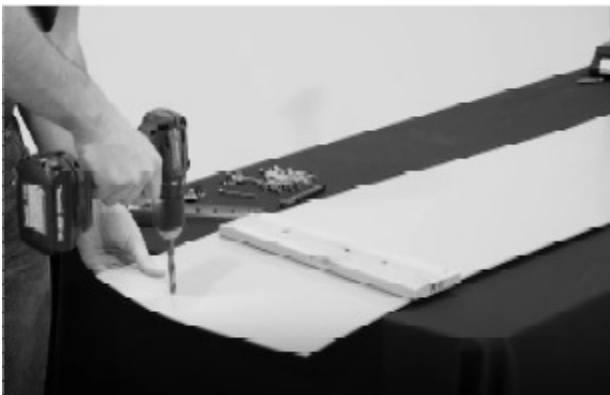

# STEP 2 - SLIDE

QTY	PART NUMBER	DESCRIPTION
8	H100006	NUT BARREL WH 5/16x1 1/2
8	H100115	BOLT WH 5/16x1/2

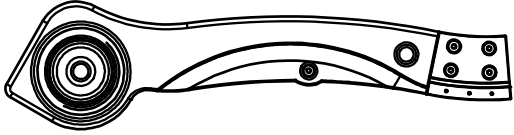

**A6P00484** | SLIDE RAIL 10' BOTTOM RIGHT GREEN  
(x1)

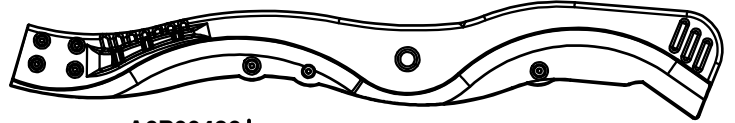

**A6P00486** | SLIDE RAIL 10' TOP RIGHT GREEN  
(x1)

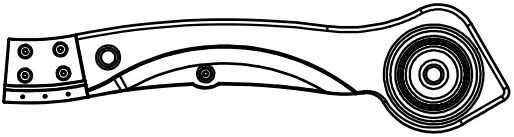

**A6P00483** | SLIDE RAIL 10' BOTTOM LEFT GREEN  
(x1)

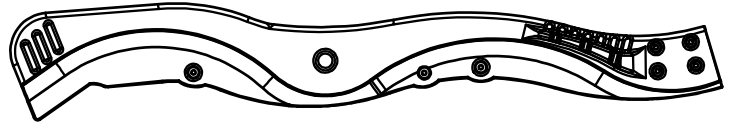

**A6P00485** | SLIDE RAIL 10' TOP LEFT GREEN  
(x1)

**NOTE:**  
REPEAT ON OTHER SIDE, MAKING  
A LEFT AND RIGHT ASSEMBLY.

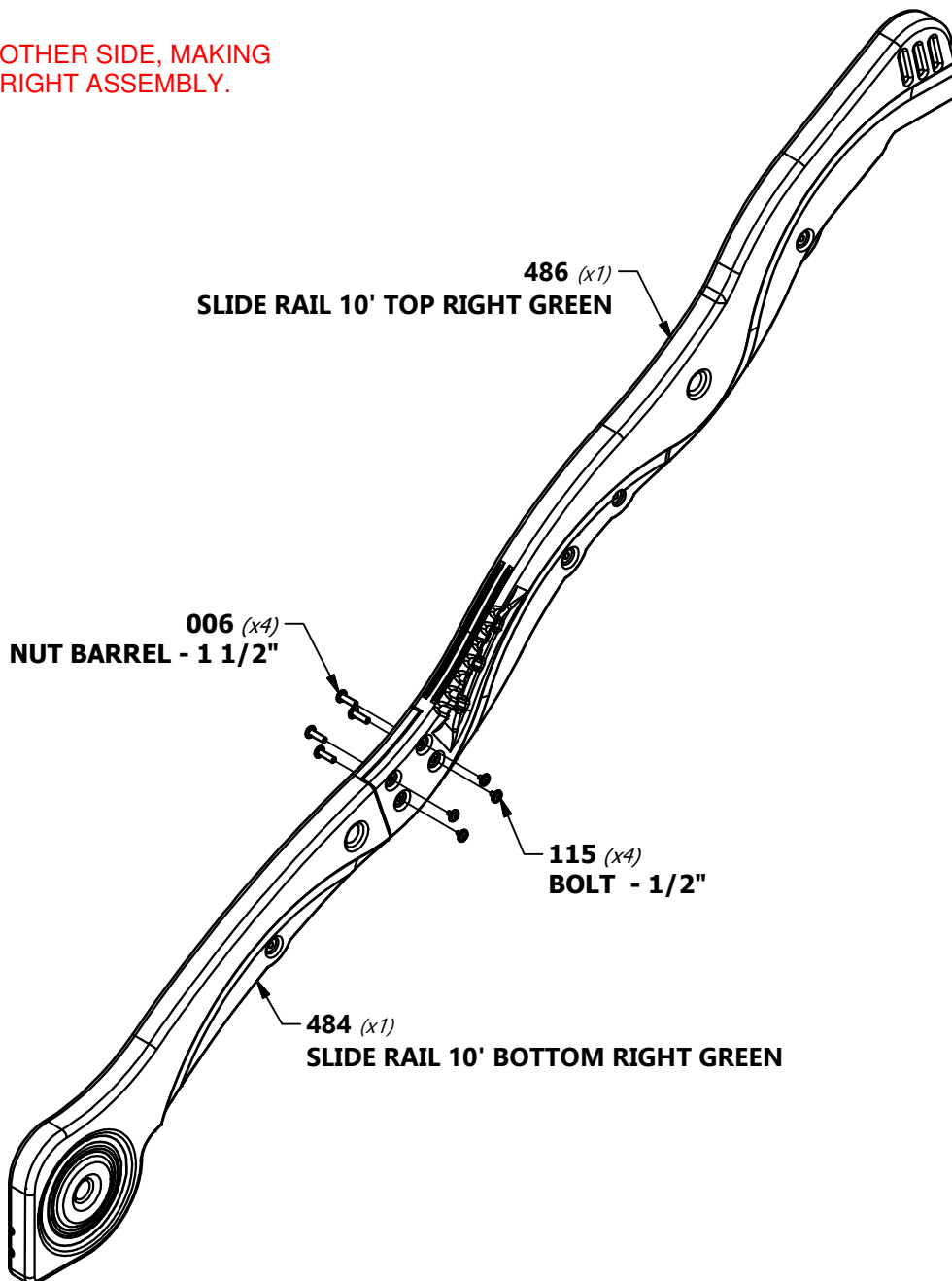

# STEP 3 - SLIDE

QTY	PART NUMBER	DESCRIPTION
4	H100009	BOLT WH 5/16x1 1/4

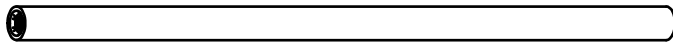

**A6P00487**  
(x4) | **SLIDE TUBE SUPPORT**

**NOTE:**  
INSERT THE (4) SLIDE SUPPORT TUBES INTO THEIR RESPECTIVE PILOT LOCATIONS (FIGURE 1).

PLACE (1) SLIDE RAIL ASSEMBLY ON A FLAT SURFACE AND BEGIN INSERTING SLIDE BED AT THE BOTTOM OF THE SLIDE RAIL (FIGURE 2). HAVE A HELPER BEND THE SLIDE BED TOWARDS THE TOP OF THE SLIDE AND INSERT THE BED INTO THE SLIDE CAVITY. MAKE SURE SLIDE BED IS INSERTED WITHIN 1/8" (3mm) OF GROOVE BOTTOM.

**TIP:**  
A HELPER IS RECOMMENDED FOR THESE FOLLOWING STEPS.

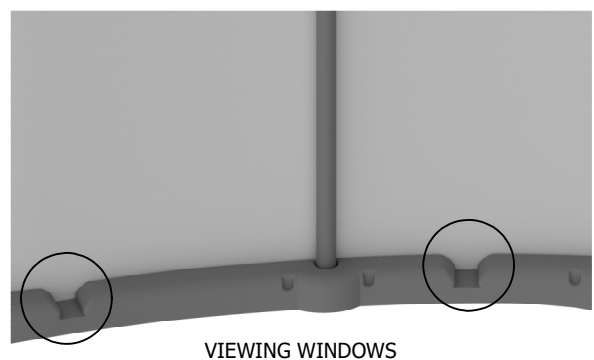
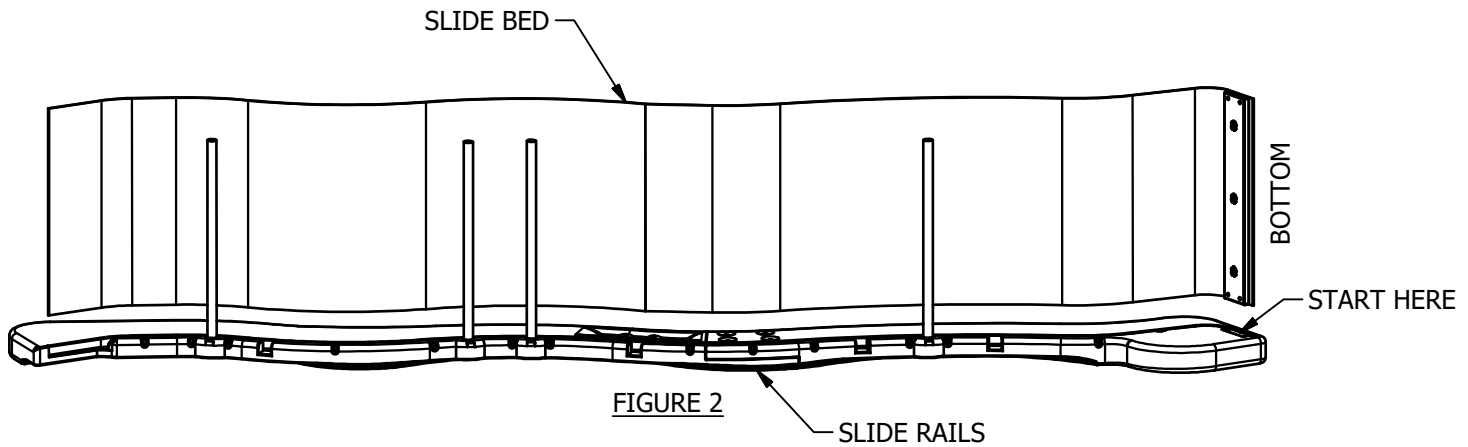
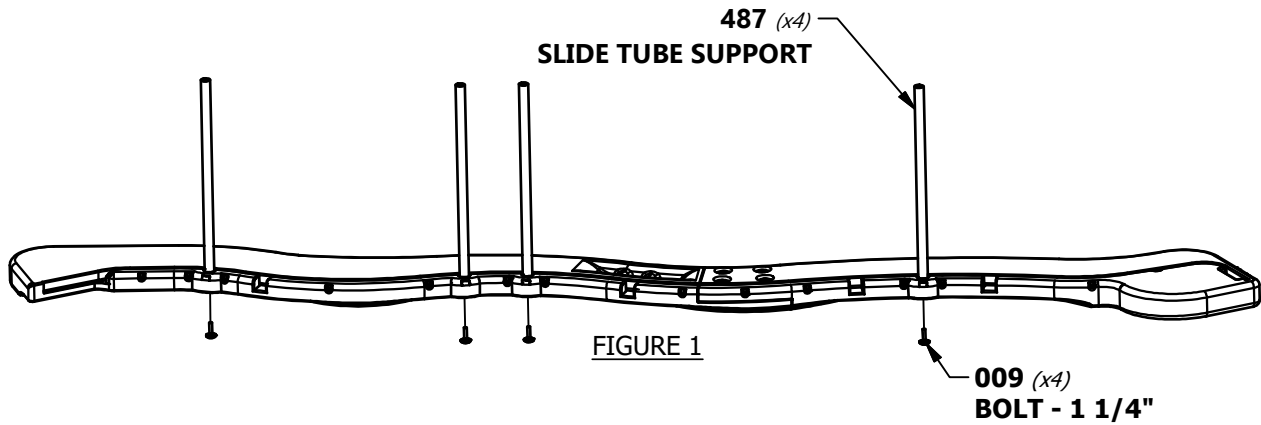

# STEP 4 - SLIDE

**NOTE:**

PLACE SECOND SLIDE RAIL ASSEMBLY OVER THE TOP OF THE SLIDE BED AND SLIDE SUPPORT TUBES. INSERT THE SLIDE BED AND SLIDE SUPPORT TUBES INTO THE SLIDE CAVITY. MAKE SURE SLIDE BED IS INSERTED WITHIN 1/8" (3mm) OF GROOVE BOTTOM.



**FAILURE TO INSERT SLIDE BED PROPERLY MAY RESULT IN INJURY OR AMPUTATION. EXPOSED SLIDE EDGES CAN BE SHARP AND BECOME A LACERATION HAZARD IF THE SLIDE IS NOT PROPERLY ASSEMBLED.**

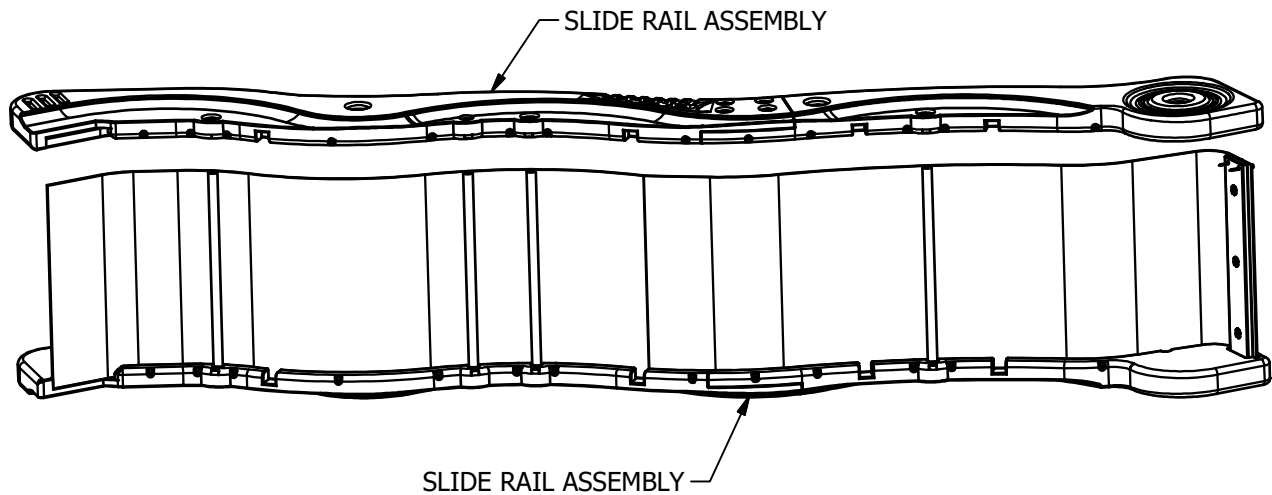

**TIP:**  
USE A RUBBER Mallet TO FULLY SEAT  
THE SLIDE BED INTO THE SLIDE CAVITY.

# STEP 5 - SLIDE

QTY	PART NUMBER	DESCRIPTION
4	H100009	BOLT WH 5/16x1 1/4

NOTE:  
USE 1 1/4" BOLTS TO FASTEN EACH  
SIDE OF THE SLIDE SUPPORT TUBES.

TIP:  
HAVING A HELPER HOLD THE SLIDE  
ASSEMBLY TOGETHER WHILE YOU FASTEN  
WILL MAKE IT EASIER TO ASSEMBLE.

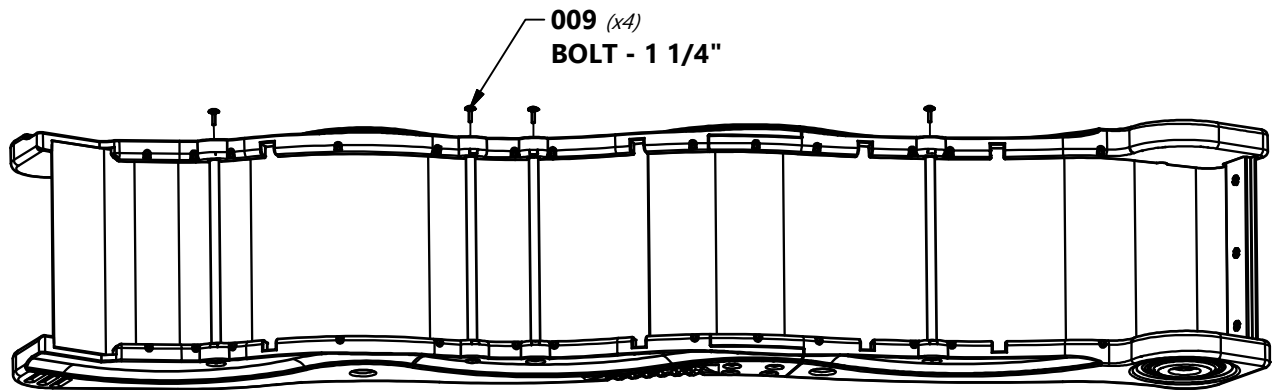

# STEP 6 - SLIDE

QTY	PART NUMBER	DESCRIPTION
30	H100090	SCREW PFH 8x2 1/2

**NOTE:**  
USING AN 1/8" DRILL BIT, DRILL PILOT HOLES IN EACH INDENTATION  
ALONG EACH SIDE RAIL. THERE SHOULD BE 15 INDENTATIONS ON  
EACH RAIL. BE SURE TO DRILL THROUGH THE SLIDE RAIL AND THE  
SLIDE BED. THEN SECURE WITH THE PROVIDED HARDWARE.

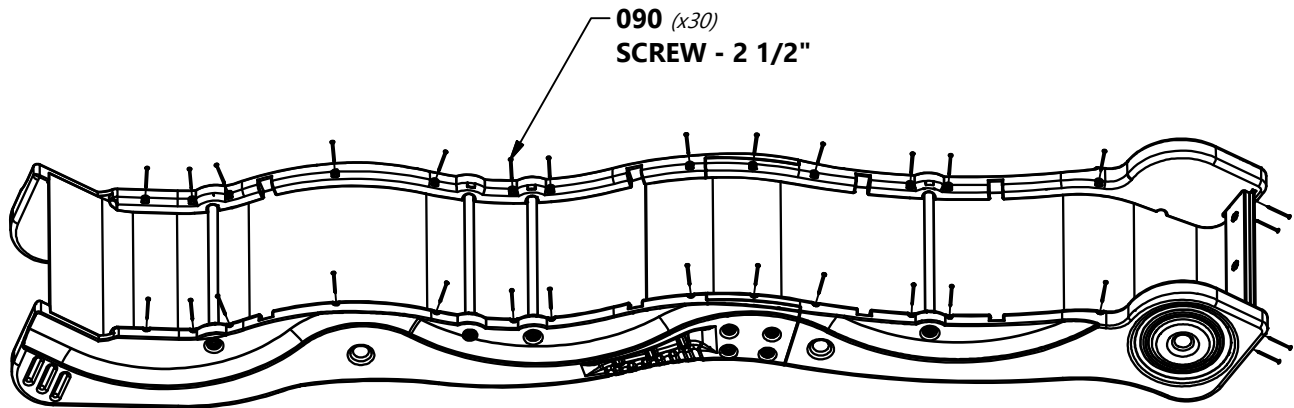

# STEP 47 - FORT ASSEMBLY

QTY	PART NUMBER	DESCRIPTION
3	H100074	T-NUT 5/16
3	H100115	BOLT WH 5/16x1/2

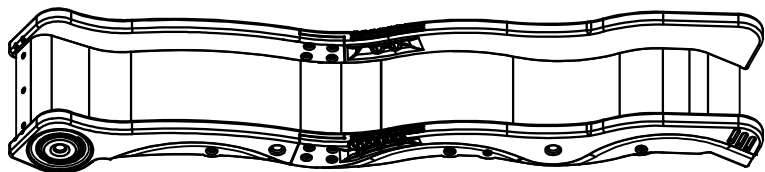

SLIDE ASSEMBLY

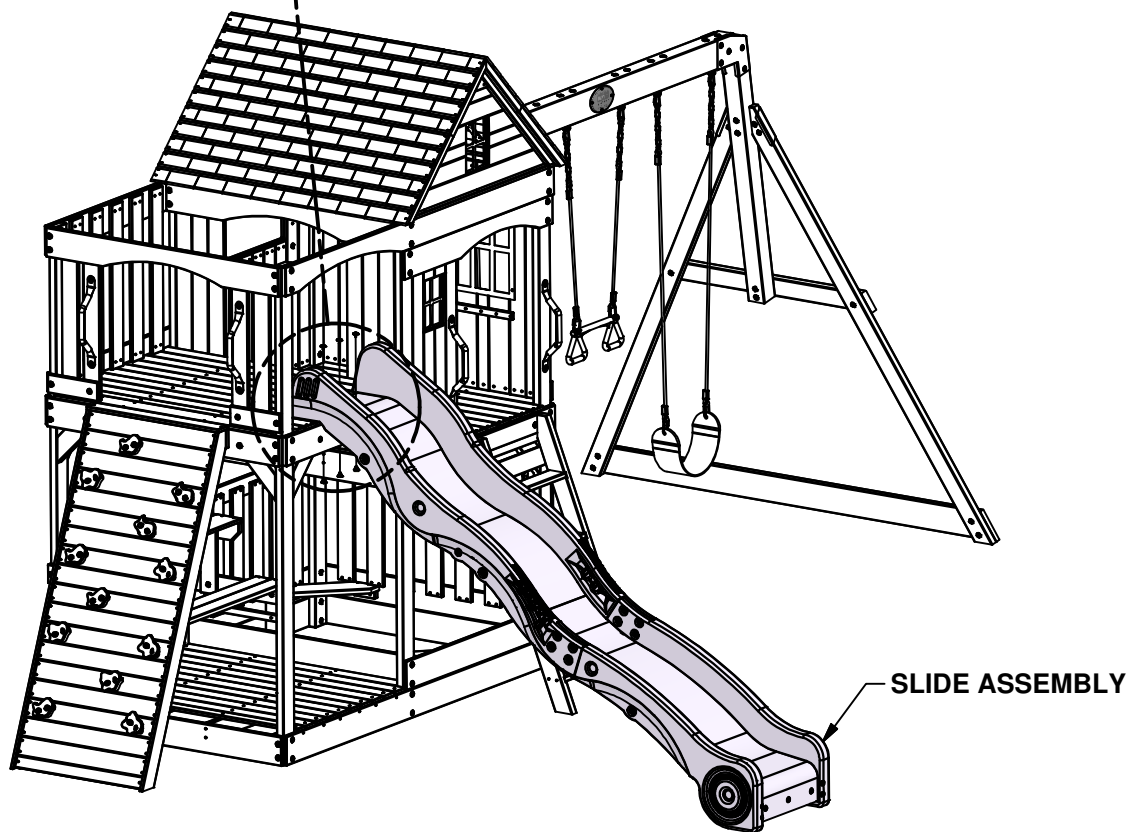
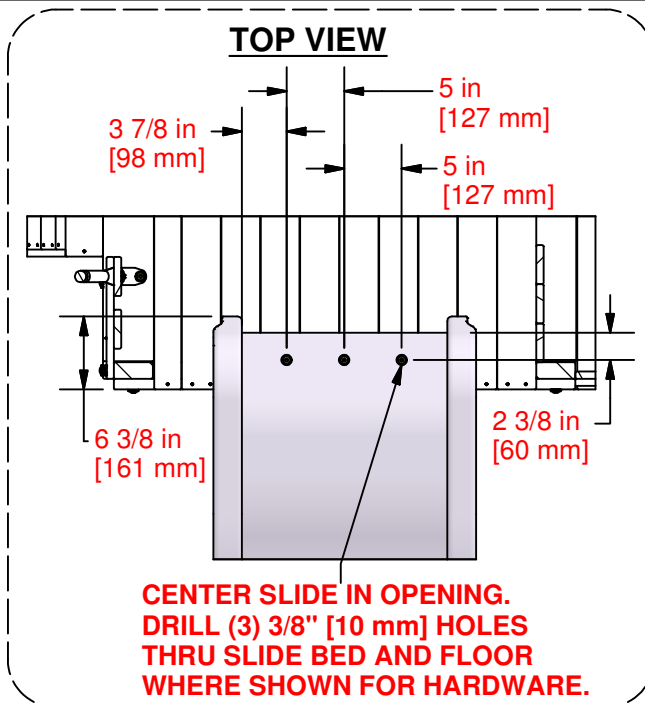
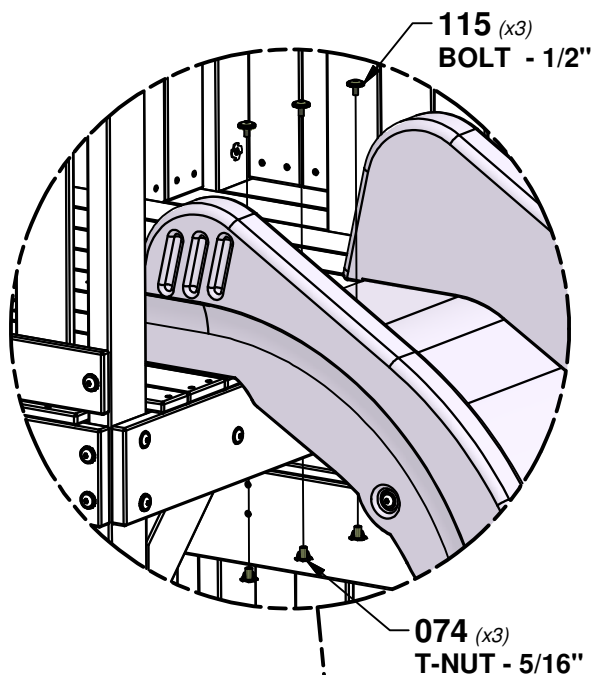

# STEP 48 - FORT ASSEMBLY

QTY	PART NUMBER	DESCRIPTION
8	H100004	NUT BARREL WH 5/16x5/8
8	H100031	WASHER LOCK EXT 12x19
2	H100008	BOLT WH 5/16x1
2	H100009	BOLT WH 5/16x1 1/4
4	H100222	BOLT WH 5/16x3/4

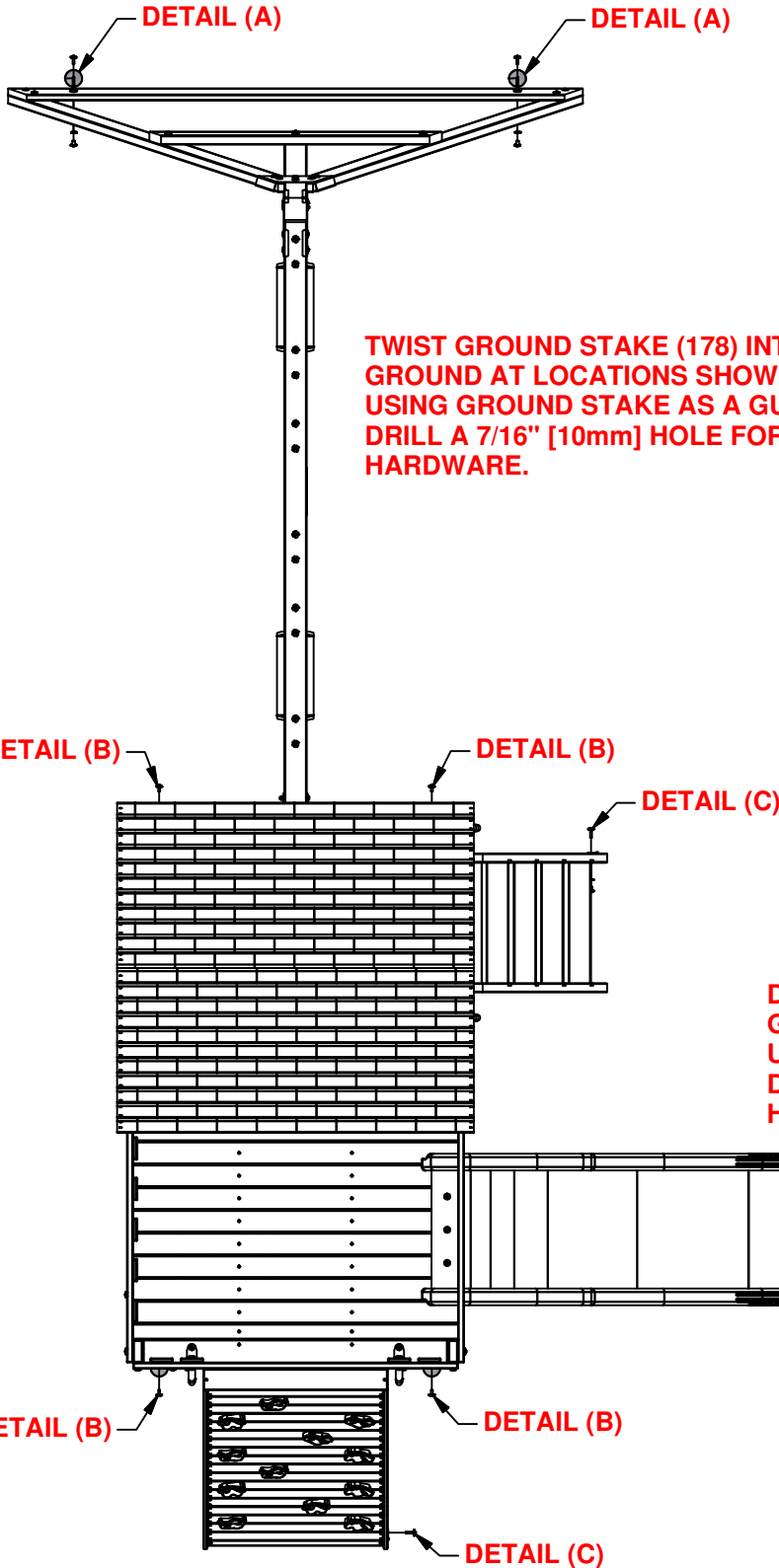

**TWIST GROUND STAKE (178) INTO GROUND AT LOCATIONS SHOWN. USING GROUND STAKE AS A GUIDE, DRILL A 7/16" [10mm] HOLE FOR HARDWARE.**

**DRIVE GROUND STAKE (527) INTO GROUND AT LOCATIONS SHOWN. USING GROUND STAKE AS A GUIDE, DRILL A 7/16" [10mm] HOLE FOR HARDWARE.**

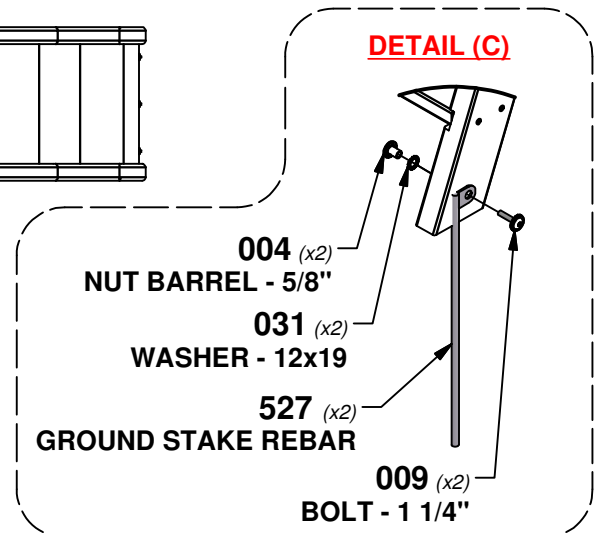
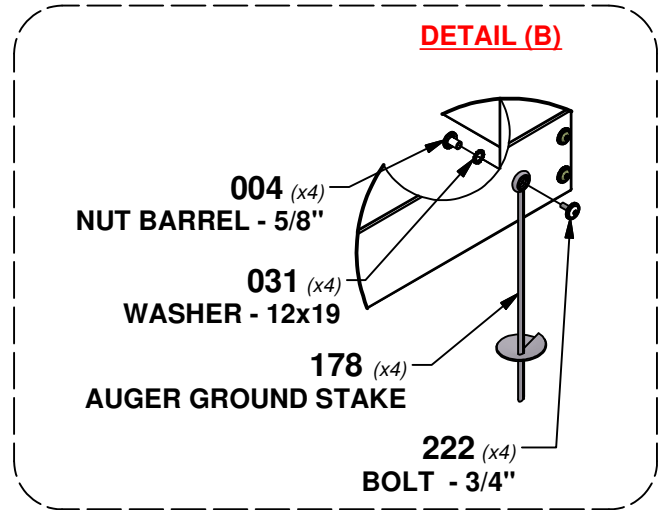
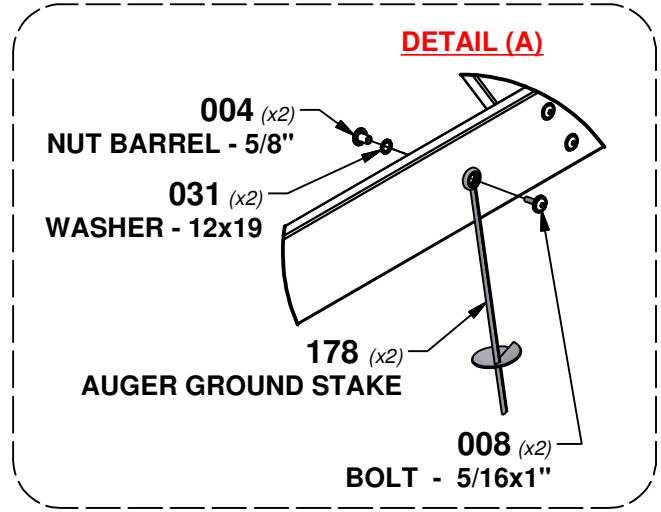

# STEP 49 - FORT ASSEMBLY

QTY	PART NUMBER	DESCRIPTION
6	H100086	SCREW PFH 8x1-1/2"

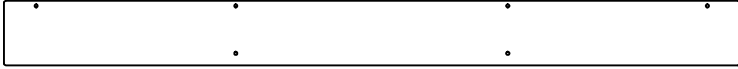

**Y01** | OUTSIDE FILLER FLOOR BOARD - W4L16087  
(x1) | 5/8"x4"x46" (16x102x1168)

