



Fabriquée par:
Backyard Discovery
3305 Airport Drive, Pittsburg, KS 66762
800-856-4445

Basepoint Business Centre: Rivermead Drive, Westlea, Swindon SN5 7EX Phone: 0800-118-2476
J.P. Coenstraat 7, The Bridge, The Hague, 2595 WP, Netherlands Phone: 0800-567-8990

FALL RIVER

Balanoire Modèle # 2400344

Veillez garder ce manuel car il contient des informations utiles



ATTENTION
MONTAGE PAR ADULTE OBLIGATOIRE:
Ne convient pas aux enfants de moins de 36 mois en raison des petites pièces.
POUR USAGE DOMESTIQUE SEULEMENT. DESTINÉ À L'EXTÉRIEUR.

CAN ICES-003 (B)/NMB-003(B)



Veillez visiter www.backyarddiscovery.com

Pour obtenir le manuel de montage le plus récent, pour enregistrer votre produit ou pour commander des pièces de rechange. Para obtener instrucciones en español, visite www.backyarddiscovery.com



PAS-À-PAS
INSTRUCTIONS INTERACTIVE EN 3D
TÉLÉCHARGEZ L'APPLICATION GRATUITEMENT



INS-2400344-A-FALL RIVER-FR 12/09/24

MANUEL DE PROPRIÉTAIRE - IDENTIFICATION DES PIÈCES

PIÈCES EN BOIS (PAS À L'ÉCHELLE)

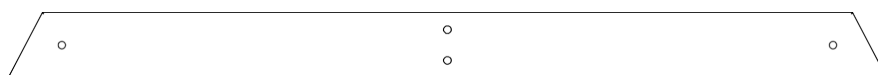

E50 SUPPORT DU BOUT - W4L19850
(x1) 1 1/2"x3 1/2"x46" (36x86x1168)

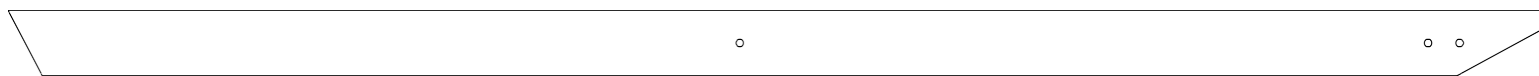

E77 SUPPORT À L'ANGLE - W4L19851
(x2) 1 3/8"x3 3/8"x81" (36x86x2056)

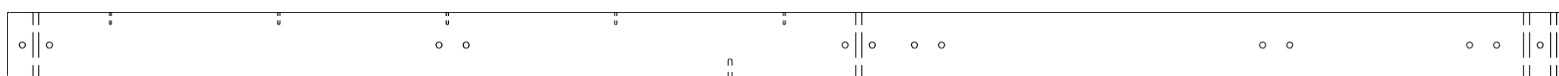

ES01 MONTANT - W4L19854
(x1) 1 1/8"x3 3/8"x81 3/4" (30x86x2076)

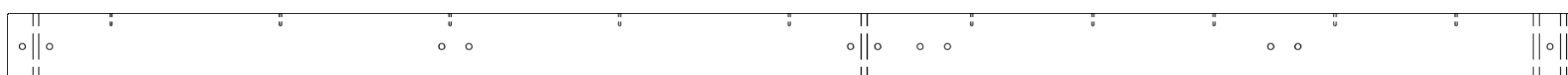

ES02 MONTANT - W4L19855
(x1) 1 1/8"x3 3/8"x81 3/4" (30x86x2076)



ES03 MONTANT - W4L19856
(x1) 1 1/8"x3 3/8"x81 3/4" (30x86x2076)

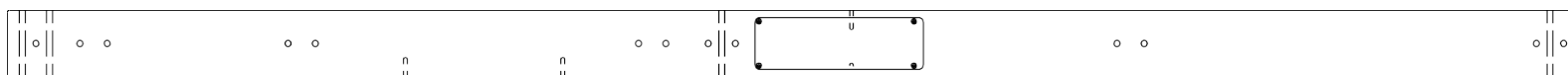

ES04 MONTANT - W2A04227
(x1) 1 1/8"x3 3/8"x81 3/4" (30x86x2076)



ES05 BILLOT À SOL - W4L19907
(x4) 1 1/8"x3 3/8"x3" (30x86x76)



**ES06 RAIL DE POUTRE DE
BALANÇOIRE - W4L19862 1**
1/8"x3"x37 1/2" (30x76x951)

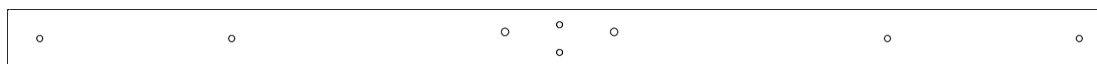

ES07 RAIL MURAL - W4L19858
(x1) 1 1/8"x3"x57 3/8" (30x76x1457)



ES74 MONTANT GAUCHE - W4L19844
(x1) 1 1/8"x3 3/8"x51" (30x86x1297)

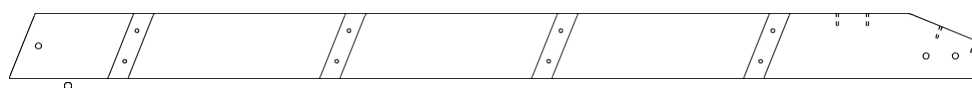

ES75 MONTANT DROIT - W4L19845
(x1) 1 1/8"x3 3/8"x51" (30x86x1297)

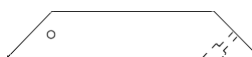

FS01 SUPPORT À L'ANGLE - W4L19857
(x3) 1 1/8"x2 3/8"x13" (30x60x330)

MANUEL DE PROPRIÉTAIRE - IDENTIFICATION DES PIÈCES

PIÈCES EN BOIS (PAS À L'ÉCHELLE)



H01 PLANCHE DE SOL - W4L19890
(x1) 1"x3"x37 1/2" (24x76x951)



H02 PLANCHE DE SOL - W4L19892
(x2) 1"x3"x37 1/2" (24x76x951)



H03 PLANCHE DE SOL - W4L19870
(x1) 1"x3"x69" (24x76x1752)



H04 BARREAU D'ÉCHELLE -
(x4) W4L19848 1"x3 3/8"x17 3/8"
(24x86x442)



H81 PLANCHE D'ATTACHEMENT -
(x1) W4L19846 1"x3 3/8"x19" (24x86x482)



HS03 SOLIVE DE SOL - W4L19860
(x1) 3/4"x3"x37 1/2" (20x76x951)



HS04 RAIL DE TOIT - W4L19859
(x1) 3/4"x3"x57 3/8" (20x76x1457)



HS06 MONTANT DE TOIT -
(x1) W4L19863 3/4"x3"x23 7/8"
(20x76x605)



HS07 PLANCHE DE TOIT - W4L19879
(x2) 3/4"x3"x37 1/2" (20x76x951)



HS08 RAIL DE TOIT - W4L19881
(x2) 3/4"x3"x39 3/8" (20x76x1001)



HS09 (x2) SUPPORT D'ÉTAGÈRE - W4L19866 3/4"x3"x4 1/2" (20x76x114)



HS10 SUPPORT AU SOL - W4L19867
(x1) 3/4"x3"x42 1/2" (20x76x1079)



HS11 MONTANT DE TOIT
(x1) W4L19868 3/4"x3"x55 7/8"

MANUEL DE PROPRIÉTAIRE - IDENTIFICATION DES PIÈCES

PIÈCES EN BOIS (PAS À L'ÉCHELLE)



HS12 RAIL MURAL - W4L19894
(x1) 3/4"x3"x19 5/8" (20x76x499)



HS13 PLANCHE DE SUPPORT -
(x1) **W4L19872 3/4"x3"x40 3/4"**
(20x76x1034)



HS15 PLANCHE MURALE - W4L19884
(x3) 3/4"x3"x37 1/2" (20x76x951)



HS17 PLANCHE MURALE - W4L19883
(x1) 3/4"x3"x37 1/2" (20x76x951)

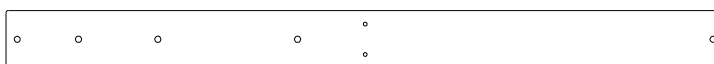

HS18 SUPPORT AU SOL - W4L19897
(x1) 3/4"x3"x37 1/2" (20x76x951)

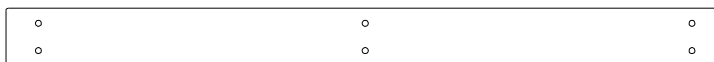

HS20 PLANCHE MURALE - W4L19898
(x2) 3/4"x3"x37 1/2" (20x76x951)



HS21 SUPPORT - W4L19887
(x1) 3/4"x3"x26 1/8" (20x76x662)

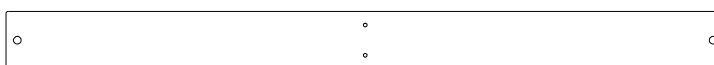

HS22 SUPPORT AU SOL - W4L19885
(x1) 3/4"x3"x37 1/2" (20x76x951)



K05 ÉTAGÈRE DE SERVICE -
(x1) **W4L19874 5/8"x5 1/4"x37 1/2"**
(16x134x951)

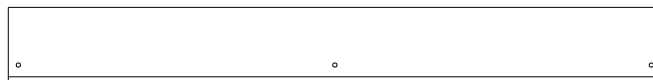

KK01 PLANCHE MURALE - W4L19876
(x7) 1/2"x3 1/2"x30 5/8" (11.9x88.9x778)

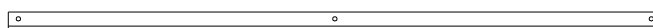

KK02 PLANCHE MURALE - W4L19875
(x1) 1/2"x7/8"x30 5/8" (11.9x22.9x778)

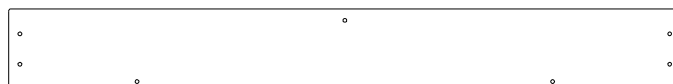

L01 PLANCHER - W4L19906
(x2) 5/8"x4 1/8"x35" (16x106x890)

MANUEL DE PROPRIÉTAIRE - IDENTIFICATION DES PIÈCES

PIÈCES EN BOIS (PAS À L'ÉCHELLE)



M01 SUPPORT ARRIÈRE -
W4L19847 5/8"x3 3/8"x19"
(x1) (16x86x482)

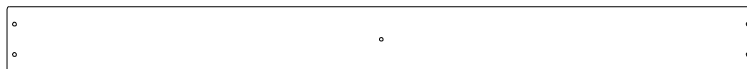

M02 PLANCHER - W4L19843
(x9) 5/8"x3 3/8"x39" (16x86x991)



M07 RAIL SUPÉRIEUR DE TOIT -
(x1) W4L19886 5/8"x3"x37 1/2"
(16x76x951)

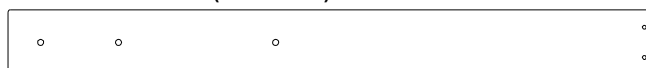

M09 PLANCHE MURALE - W4L19888
(x1) 5/8"x3 3/8"x33 5/8" (16x86x854)



M10 PIQUET - W4L19889
(x2) 5/8"x3 3/8"x32 1/8" (16x86x816)



M14 PIQUET - W4L19893
(x9) 5/8"x3 3/8"x18 1/4" (16x86x463)



M77 SUPPORT À TOBOGGAN-
(x1) W4L12363 5/8"x3 3/8"x14 1/4"
(16x86x362)



M78 SUPPORT À TOBOGGAN DU
(x2) CENTRE- W4L12362 5/8"x3 3/8"x14
1/4" (16x86x362)

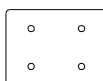

N01 TAQUET - W4L19902
(x3) 5/8"x2 3/8"x3 1/8" (16x60x80)

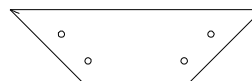

N02 CALE DE PORTE - W4L19896
(x1) 5/8"x2 3/8"x7 7/8" (16x60x200)



N04 PLANCHE MURALE -
(x1) W4L19869 5/8"x2 3/8"x40"
(16x60x1017)



N06 PLANCHE MURALE - W4L19864
(x2) 5/8"x2 3/8"x18 3/4" (16x60x477)



N07 PLANCHE MURALE - W4L19865
(x1) 5/8"x2 3/8"x18 3/4" (16x60x477)

MANUEL DE PROPRIÉTAIRE - IDENTIFICATION DES PIÈCES

PIÈCES EN BOIS (PAS À L'ÉCHELLE)



SB74 POUTRE DE BALANÇOIRE LONG - W4L19849
(x1) 2"x5 1/4"x89 1/2" (50x134x2274)



W71 SUPPORT À POUTRE DE BALANÇOIRE - W4L19853
(x1) 2"x3 3/8"x49 7/8" (50x86x1266)

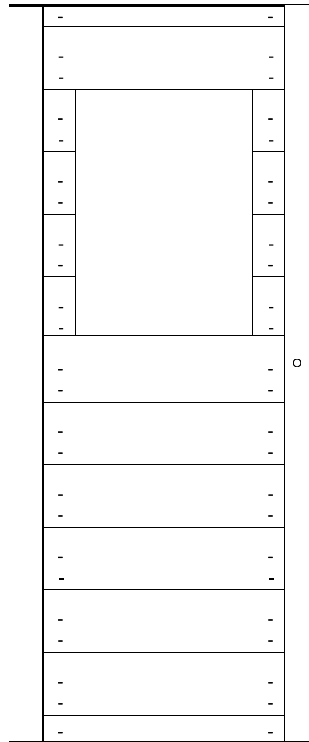

DP01 PANNEAU DE PORTE - W2A04226
(x1) 1"x16"x38 5/8" (24x407x980)

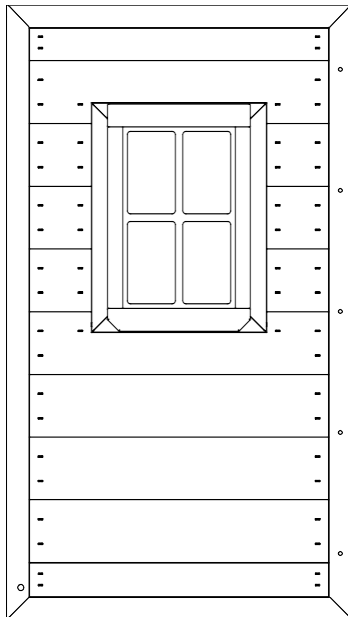

WP01 PANNEAU MURAL - W2A04225
(x1) 1 3/8"x18"x32" (36x455x813)

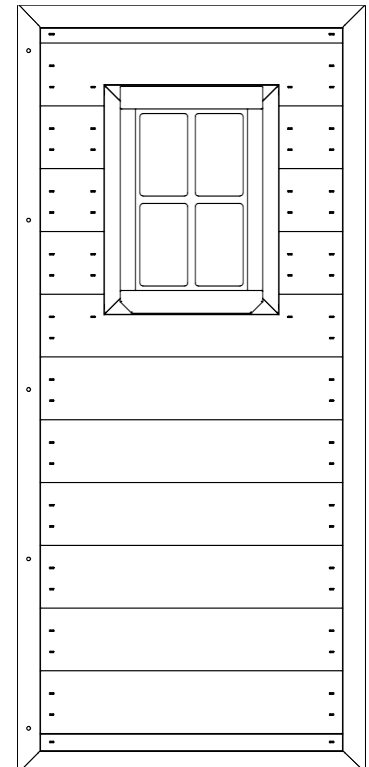

WP02 PANNEAU MURAL - W2A04228
(x1) 1 3/8"x18"x40" (36x460x1017)

MANUEL DE PROPRIÉTAIRE - IDENTIFICATION DES PIÈCES

PIÈCES DE QUINCAILLERIE

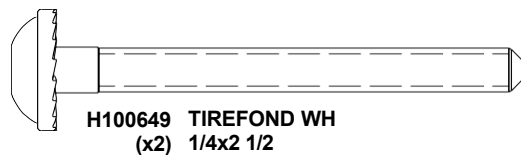
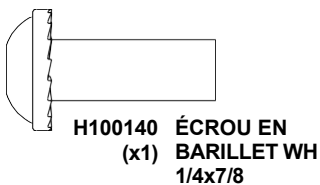
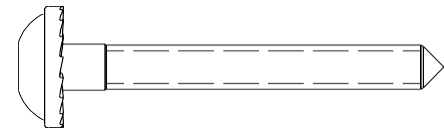
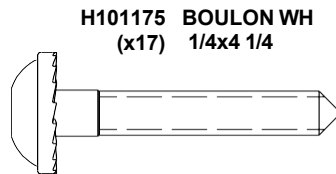
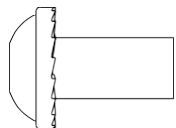
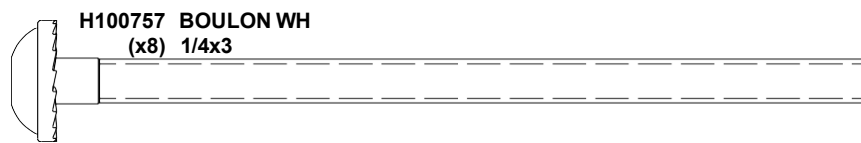
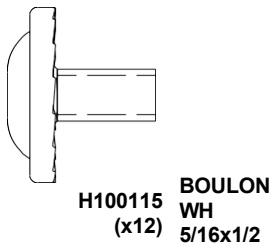
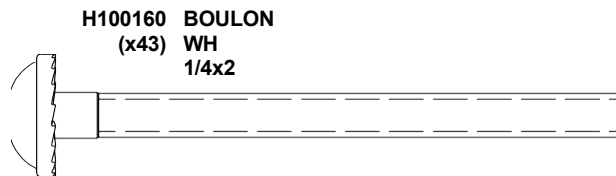
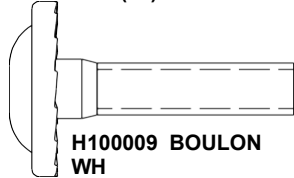
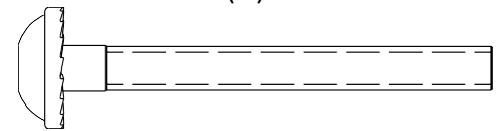
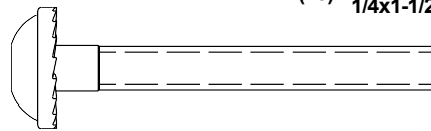
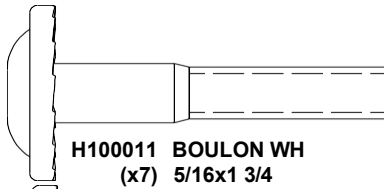
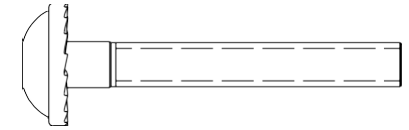
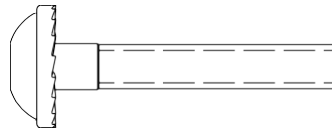
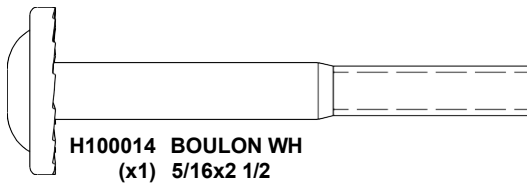
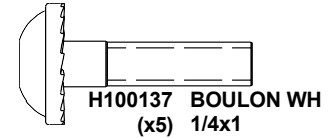
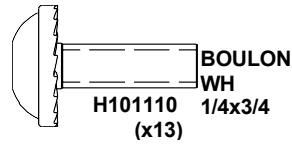
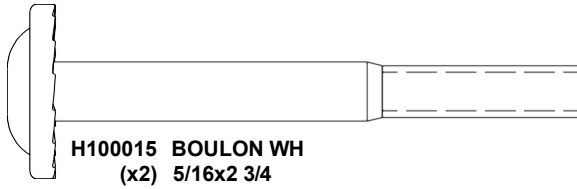
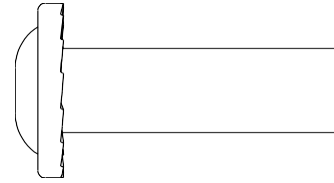
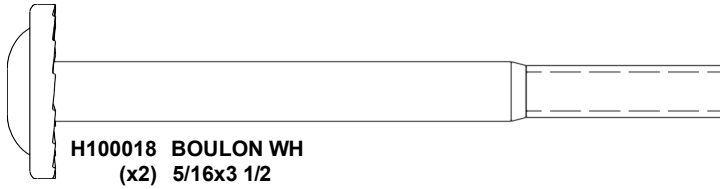
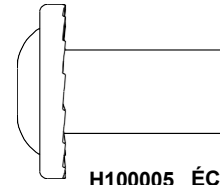
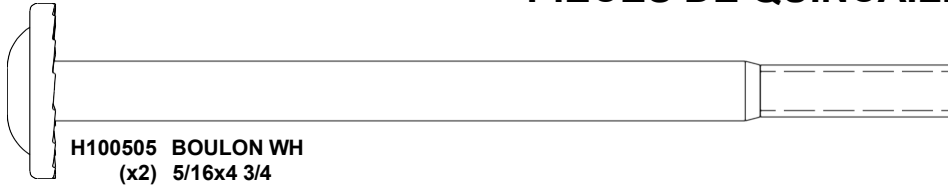

MANUEL DE PROPRIÉTAIRE - IDENTIFICATION DES PIÈCES

PIÈCES DE QUINCAILLERIE

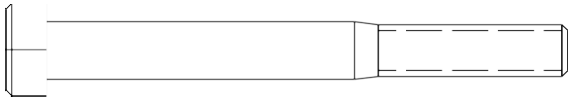

H100047 BOULON
(x2) HEX
5/16x2 3/4

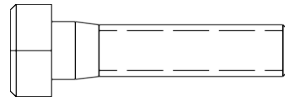

H100042 BOULON HEX
(x4) 5/16x1 1/4

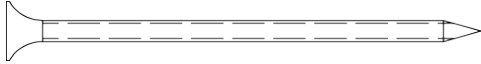

H100090 VIS PFH
(x30) 8x2 1/2"

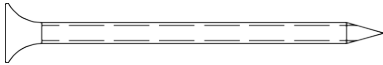

H100111 VIS PFH
(x26) 8x2

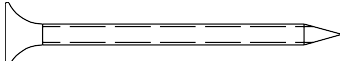

H100089 VIS PFH
(x4) 8x1 3/4



H100086 VIS PFH
(x93) 8x1 1/2

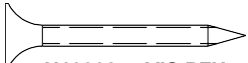

H100087 VIS PFH
(x12) 8x1 1/4



H100088 VIS PFH
(x50) 8x1 1/8

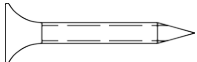

H100085 VIS PFH
8x1

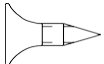

(x24)
H100124 VIS PFH
(x4) 8 x 1/2

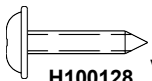

H100128 VIS PWH
(x52) 8x5/8

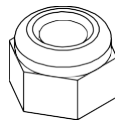

H100110 ÉCROU
(x6) D'ARRÊT
5/16

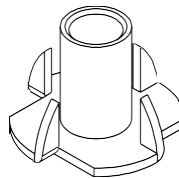

H100074 ÉCRO
(x74) U EN
T 5/16

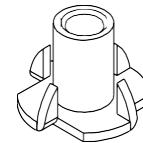

H100072 ÉCROU EN T
(x100)

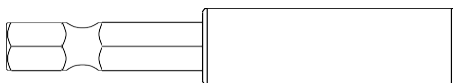

H100110 MANDRIN MAGNÉTIQUE
(x1)

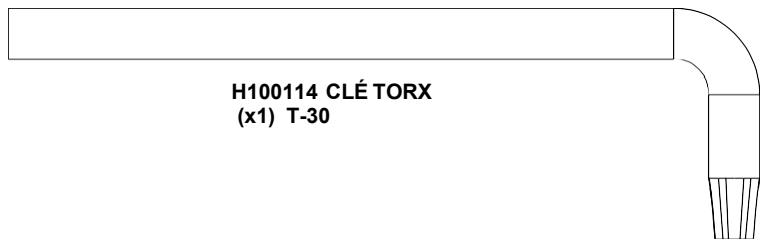

H100114 CLÉ TORX
(x1) T-30

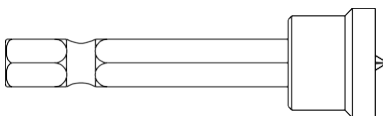

H100764 NIVEAU DE VIS
(x1)



H100147 TORX BIT
(x1) T-30

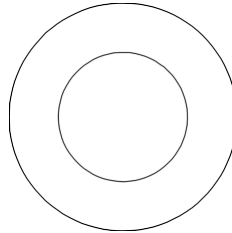

H100103 RONDELLE DE
(x4) SÉCURITÉ 17x30

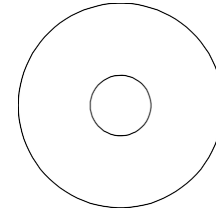

H100105 RONDELLE
(x12) PLATE 8x27

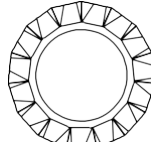

H100031 RONDELLE
(x8) D'ARRÊT EXT 12x19

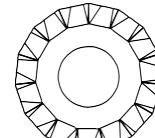

H100030 RONDELLE
(x4) D'ARRÊT EXT 8x19

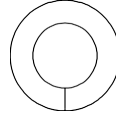

H100095 RONDELLE
(x4) FENDUE 5/16

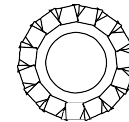

H100138 RONDELLE
(x97) D'ARRÊT EXT 6x15

MANUEL DE PROPRIÉTAIRE - IDENTIFICATION DES PIÈCES

COMPONENTS ACCESSOIRES (PAS À L'ÉCHELLE)

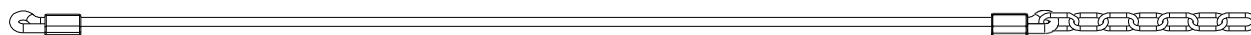

A100087 CHAÎNE À
(x4) CORDE VERT
51.25"

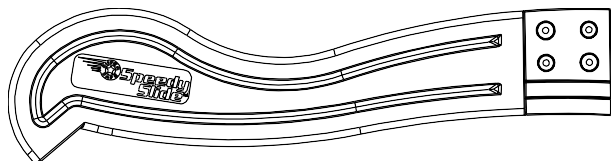

A6P00102 RAIL
(x1) SUPÉRIEUR DU
TOBOGGAN
GAUCHE

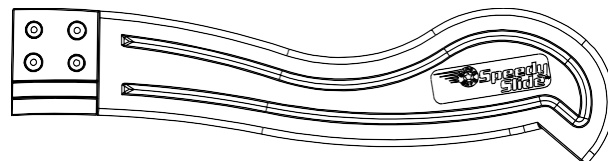

A6P00104 RAIL
(x1) SUPÉRIEUR DU
TOBOGGAN
DROIT



A6P00103 RAIL
(x1) INFÉRIEUR DU
TOBOGGAN
GAUCHE

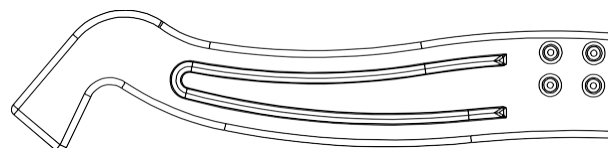

A6P00105 RAIL
(x1) INFÉRIEUR DU
TOBOGGAN
DROIT

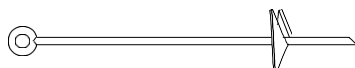

A100178 PIQUET
(x6) FOREUSE



A100164 ÉTIQUETTE
(x1) LOGO BYD
(LARGE)

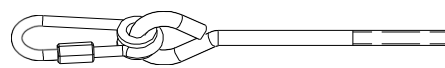

H100099 9 1/2" PORTE- BALANÇOIRE
(x4) QUICK LINK

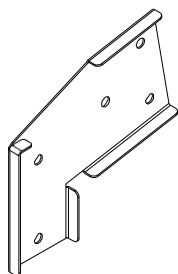

A100325 EXTENSEUR DE
(x1) POUTRE DE
BALANÇOIR-
GAUCHE

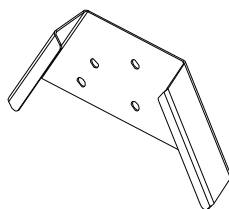

A4M01169 A-FRAME
(x1) SUPPORT

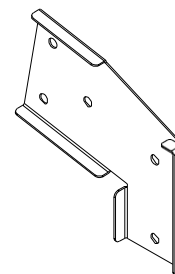

A100326 EXTENSEUR DE
(x1) POUTRE DE
BALANÇOIR-
DROIT

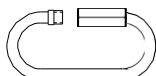

A100069 QUICK LINK
(x4)



A6P00054 SIÈGE À
(x2) BALANÇOIRE
E 22"



A100028 POIGNÉE VERTE
(x2)

MANUEL DE PROPRIÉTAIRE - IDENTIFICATION DES PIÈCES

COMPONENTS ACCESSOIRES (PAS À L'ÉCHELLE)

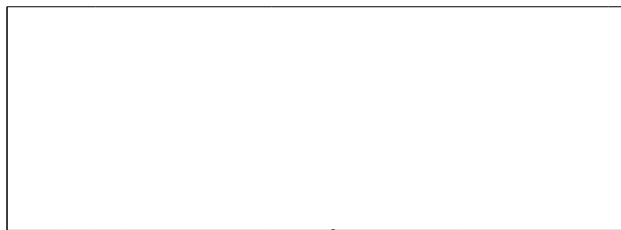

A6P00325 SIÈGE DU TOBOGGAN
(x1) DK.VERTE

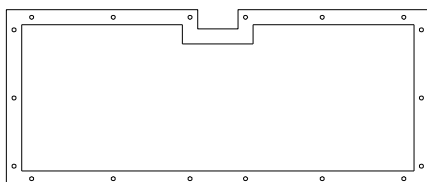

A6P01382 PANNEAU
(x1) EN FILET

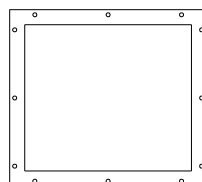

A6P01383 PANNEAU EN FILET
(x2)

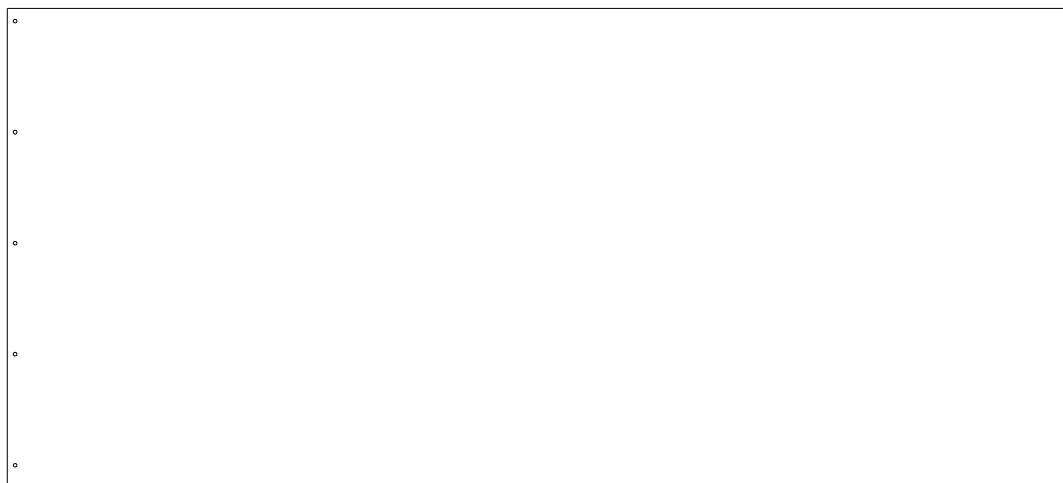

A6P01172 BÂCHE À TOIT
(x1)

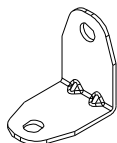

A4M01046 SUPPORT
(x8) EN L
2.5x38x55x55

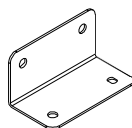

A100140 SUPPORT
(x2) EN L
66x66x127

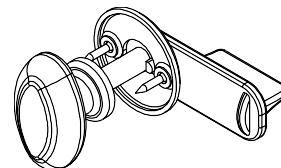

A6P01381 POIGNÉE D'ENCLIQUETAGE
(x1)

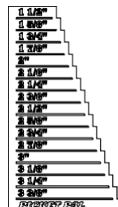

A6P00410 AIDE-PIQUET
(x1)

PRÉ-ASSEMBLAGE ÉTAPE 1 - TRI DES PIÈCES

Il est essentiel pour faciliter l'assemblage que vous preniez le temps de trier et d'organiser les pièces et le matériel.

PIÈCES DE BOIS :

- Organiser les pièces de bois selon le numéro alphanumérique à trois chiffres estampillé sur chaque panneau (p. ex., P01).
- S'il y a plusieurs planches avec le même numéro estampillé, empilez ces pièces ensemble.
- Les timbres se trouvent sur la surface plane des planches ou à l'extrémité des planches.
- Laissez-vous beaucoup de place - les morceaux de bois peuvent prendre beaucoup de place.

REMARQUE : LES CARTONS NE SONT PAS CLASSÉS PAR NUMÉRO DE PIÈCE.

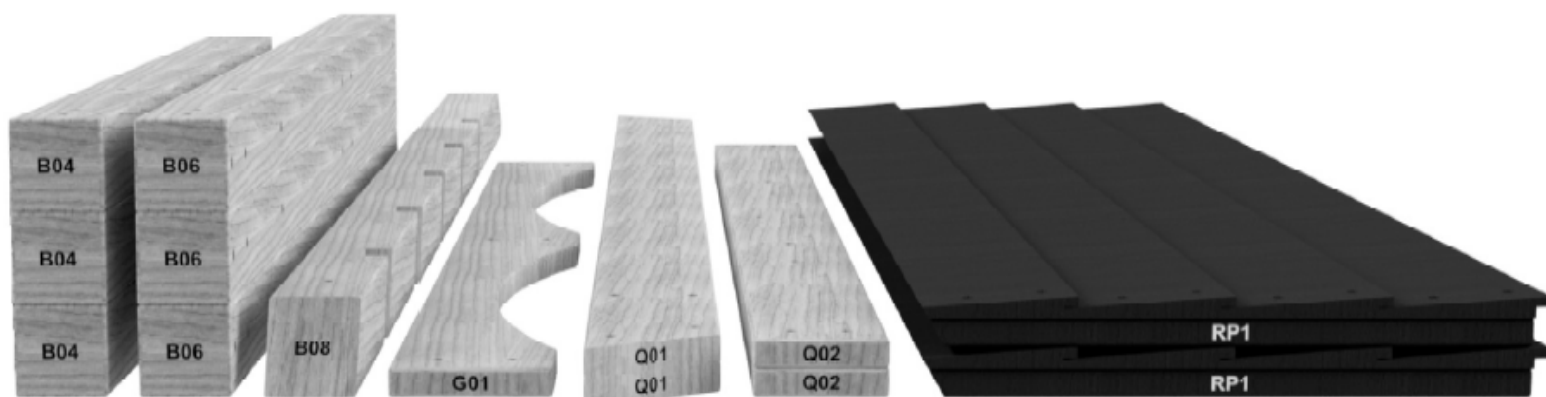

PIÈCES DE QUINCAILLERIE :

- Nous vous recommandons d'avoir un tableau séparé pour organiser le matériel.
- Les sacs de quincaillerie sont imprimés avec un numéro de pièce alphanumérique à sept chiffres.
- Vous pouvez organiser votre matériel par numéro de pièce ou groupe par type de matériel (boulons, écrous, etc.).
- Pendant l'assemblage, il suffit de faire référence aux quatre derniers chiffres du numéro.

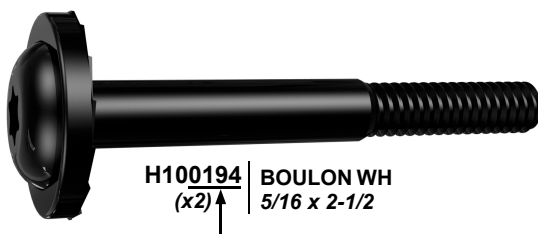

PRÉ-ASSEMBLAGE ÉTAPE 2 - OUTILS NÉCESSAIRES



PERCEUSE SANS
FIL OU
PERCEUSE
ÉLECTRIQUE



ACCESSOIRES DE LA
PERCEUSE : MÈCHE
CRUCIFORME



FORETS DE 1/8 PO, 3/16
PO, 3/8 PO ET 7/16 PO



TOURNEVIS CRUCIFORM

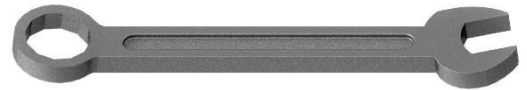

CLÉS OUVERTES DE
1/2 PO ET 9/16 PO



CLÉ À CLIQUET DE 3/8 PO,
DOUILLES STANDARD DE 1/2 PO
ET 7/16 PO, DOUILLES
PROFONDES DE 1/2 PO ET 7/16 PO



MARTEAU À PANNE FENDUE

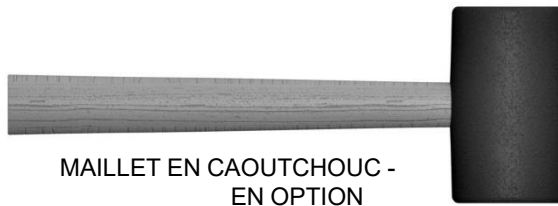

MAILLET EN CAOUTCHOUC -
EN OPTION

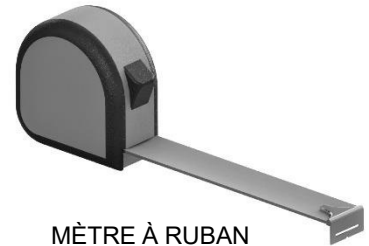

MÈTRE À RUBAN

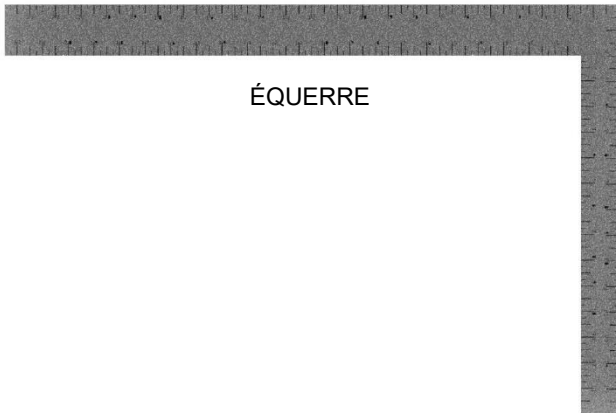

ÉQUERRE



NIVEAU DE 24 PO

PRÉ-ASSEMBLAGE ÉTAPE 3 - CHOISISSEZ VOTRE MÉTHODE D'ASSEMBLAGE

Plusieurs types d'instructions de montage vous sont proposés.

1. Manuel d'assemblage imprimé inclus avec votre produit
2. Application BILT - Instructions interactives en 3D (en Anglais)
3. Combinaison du manuel imprimé et de l'application BILT (remarque : les numéros d'étape peuvent différer entre les deux méthodes)



Scannez pour des instructions 3D faciles

Téléchargez l'application BILT avant de commencer



The image shows a smartphone screen displaying the BILT app interface. The screen features a 3D assembly diagram of a metal frame with a horizontal beam and several hanging components. The interface includes a 'Hardware Needed' button at the top left, a close button (X) at the top right, a menu button (three dots) and a volume icon below it, and navigation buttons (back, play/pause, forward) at the bottom. A page number '17' is visible in the bottom left corner of the app screen.

ÉTAPE 1 - ÉCHELLE

QTÉ	N° DE PIÈCE	DESCRIPTION
8	H100111	VIS PFH 8x2

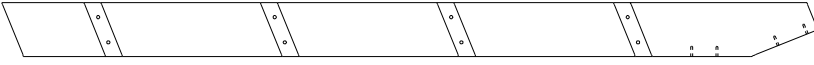

ES74 GAUCHE MONTANT - W4L19844
(x1) 1 1/8"x3 3/8"x51" (30x86x1297)

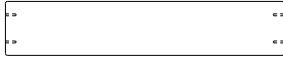

H04 BARREAU D'ÉCHELLE - W4L19848
(x4) 1"x3 3/8"x17 3/8" (24x86x442)

ALIGNEZ LES TROUS PILOTES

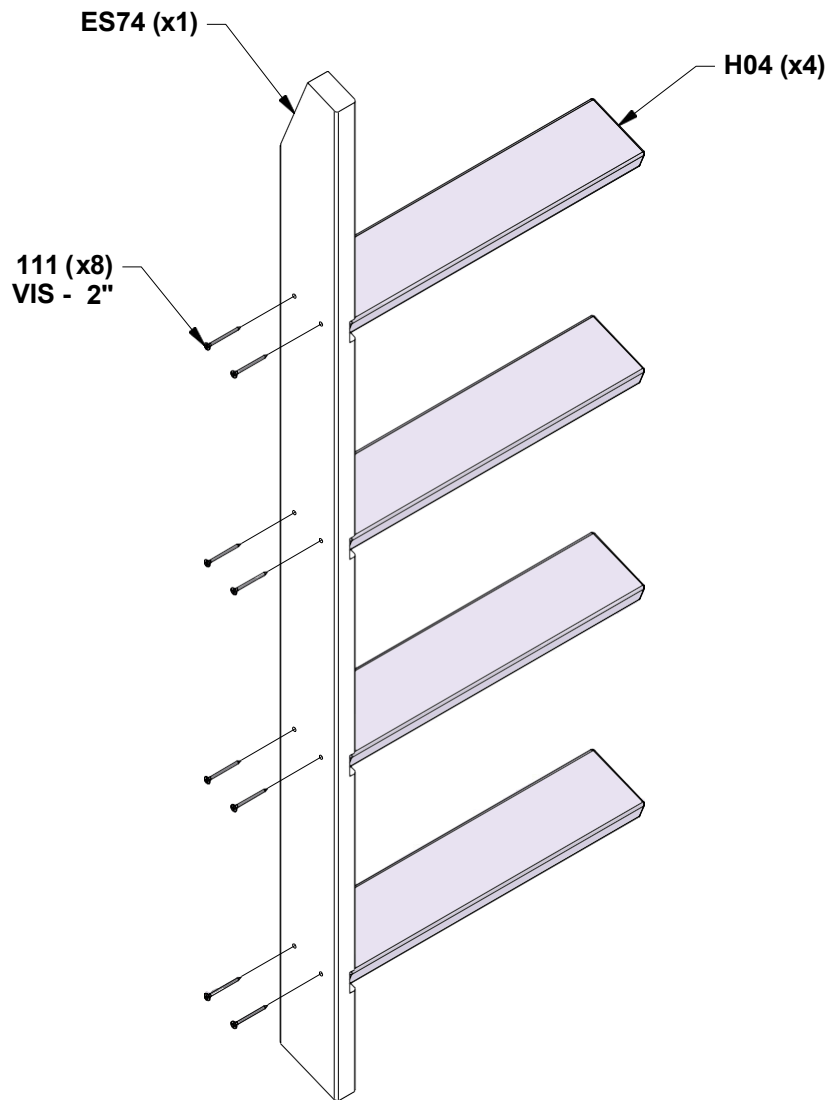

ÉTAPE 2 - ÉCHELLE

QTÉ	N° DE PIÈCE	DESCRIPTION
8	H100111	VIS PFH 8x2



ES75 DROIT MONTANT - W4L19845
(x1) 1 1/8"x3 3/8"x51" (30x86x1297)

**ALIGNER LES TROUS
PILOTES**

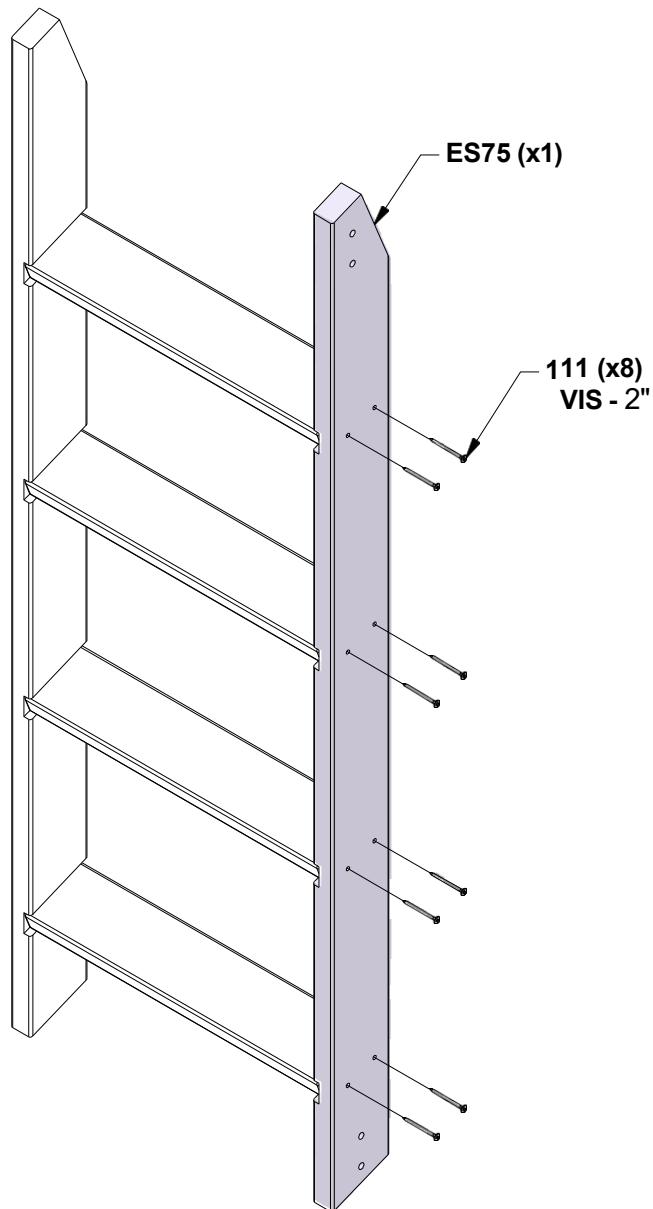

ÉTAPE 3 - ÉCHELLE

QTÉ	N° DE PIÈCE	DESCRIPTION
4	H100086	VIS PFH 8x1-1/2



M01 SUPPORT ARRIÈRE - W4L19847
(x1) 5/8"x3 3/8"x19" (16x86x482)

ALIGNEZ LES TROUS PILOTES

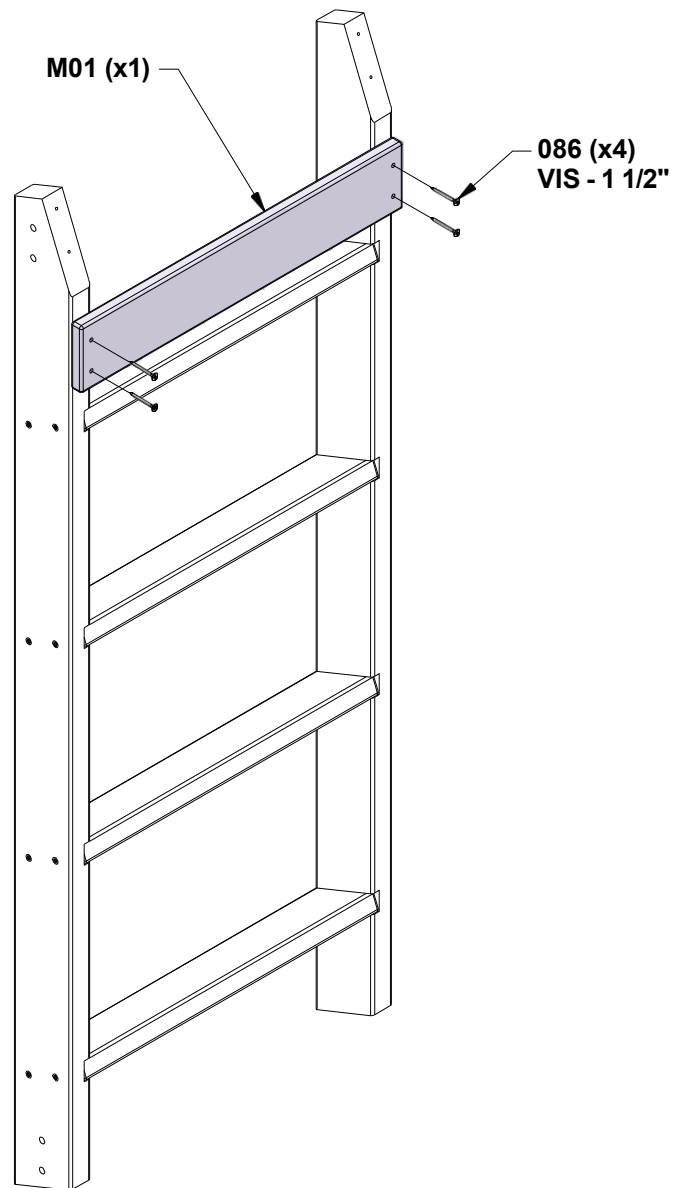

ÉTAPE 4 - ÉCHELLE

QTÉ	N° DE PIÈCE	DESCRIPTION
4	H100089	VIS PFH 8x1-3/4



H81 PLANCHE D'ATTACHEMENT - W4L19846
(x1) 1"x3 3/8"x19" (24x86x482)

ALIGNER LES TROUS PILOTES

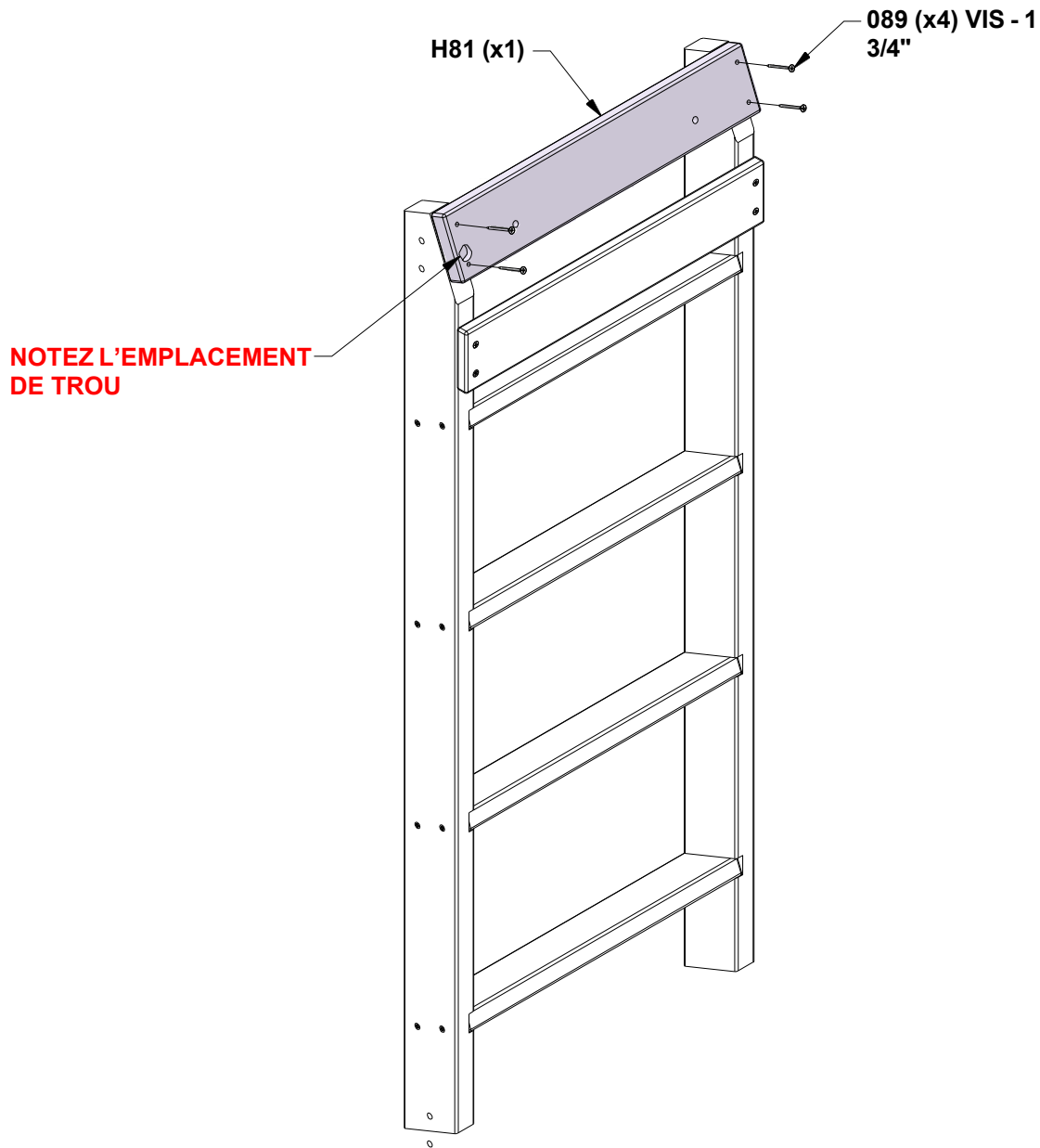

ÉTAPE 1 - POUTRE DE BALANÇOIRE



SB74 POUTRE DE BALANÇOIRE LONG - W4L19849
(x1) 2"x5 1/4"x89 1/2" (50x134x2274)

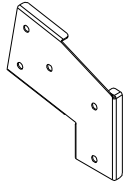

A100325 EXTENSEUR DE POUTRE DE BALANÇOIRE - GAUCHE
(x1)

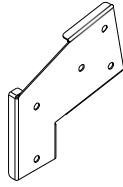

A100326 EXTENSEUR DE POUTRE DE BALANÇOIRE - DROIT
(x1)

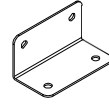

A100140 SUPPORT EN L
(x2) 66x66x127

QTÉ	N° DE PIÈCE	DESCRIPTION
3	H100005	ÉCROU EN BARILLET WH 5/16x7/8
3	H100011	BOULON WH 5/16x1 3/4
2	H100047	BOULON HEX 5/16x2-3/4
4	H100105	RONDELLE PLATE 8x27
2	H100110	ÉCROU D'ARRÊT 5/16

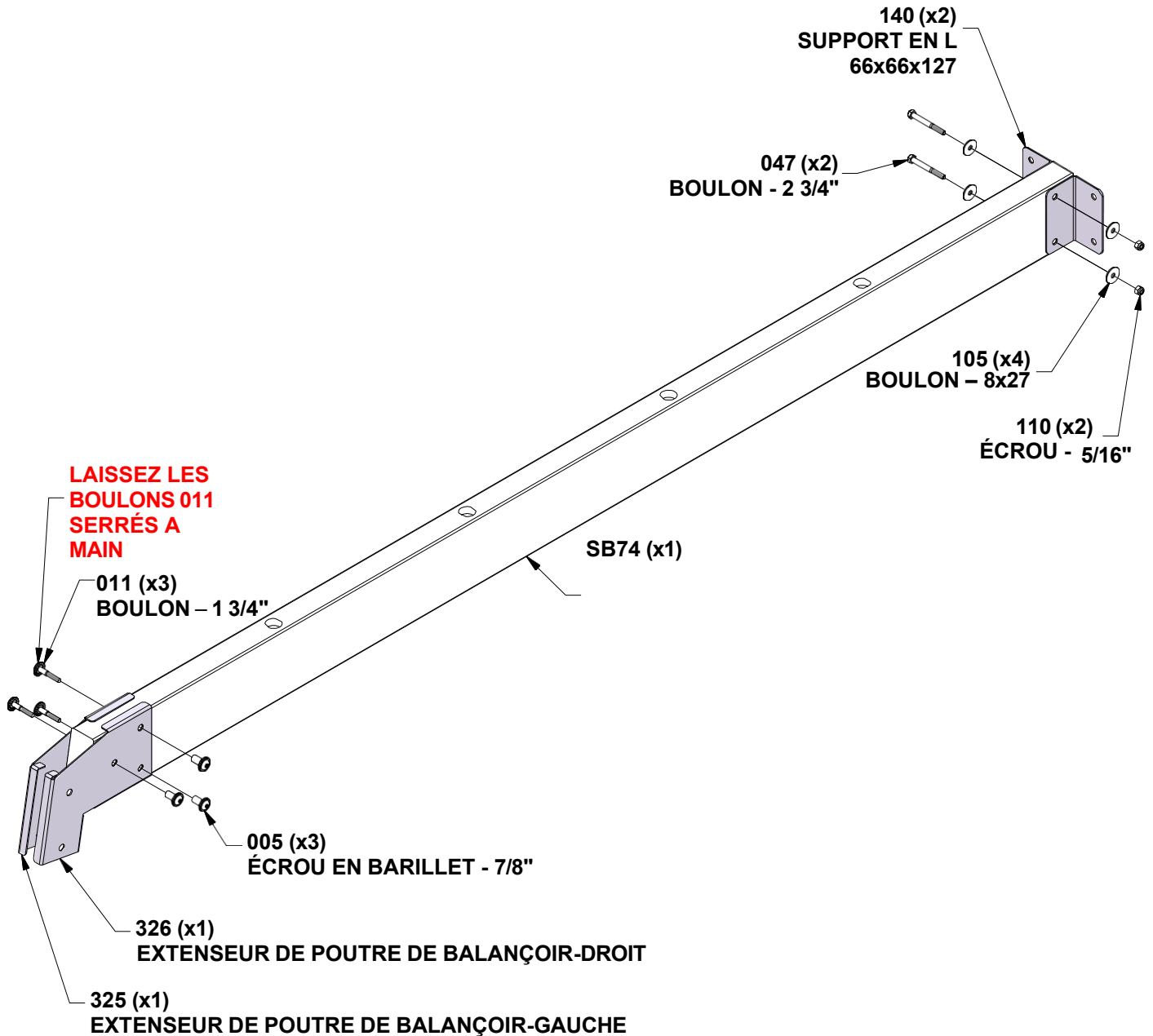

ÉTAPE 2 - POUTRE DE BALANÇOIRE

E77 SUPPORT À L'ANGLE - W4L19851
(x2) 1 3/8"x3 3/8"x81" (36x86x2056)

E50 SUPPORT DU BOUT - W4L19850
(x1) 1 1/2"x3 1/2"x46" (36x86x1168)

W71 POUTRE DE BALANÇOIRE - W4L19853
(x1) 2"x3 3/8"x49 7/8" (50x86x1266)

A4M01169 SUPPORT
(x1) A-FRAME

QTÉ	N° DE PIÈCE	DESCRIPTION
4	H100009	BOULON WH 5/16x1 1/4
2	H100015	BOULON WH 5/16x2 3/4
2	H100018	BOULON WH 5/16x3 1/2
4	H100030	RONDELLE D'ARRÊT EXT 8x19
10	H100074	ÉCROU EN T 5/16
2	H100505	BOULON WH 5/16x4 3/4

INSTALLEZ LES ÉCROUS EN T DANS LE BOIS TOUT D'ABORD

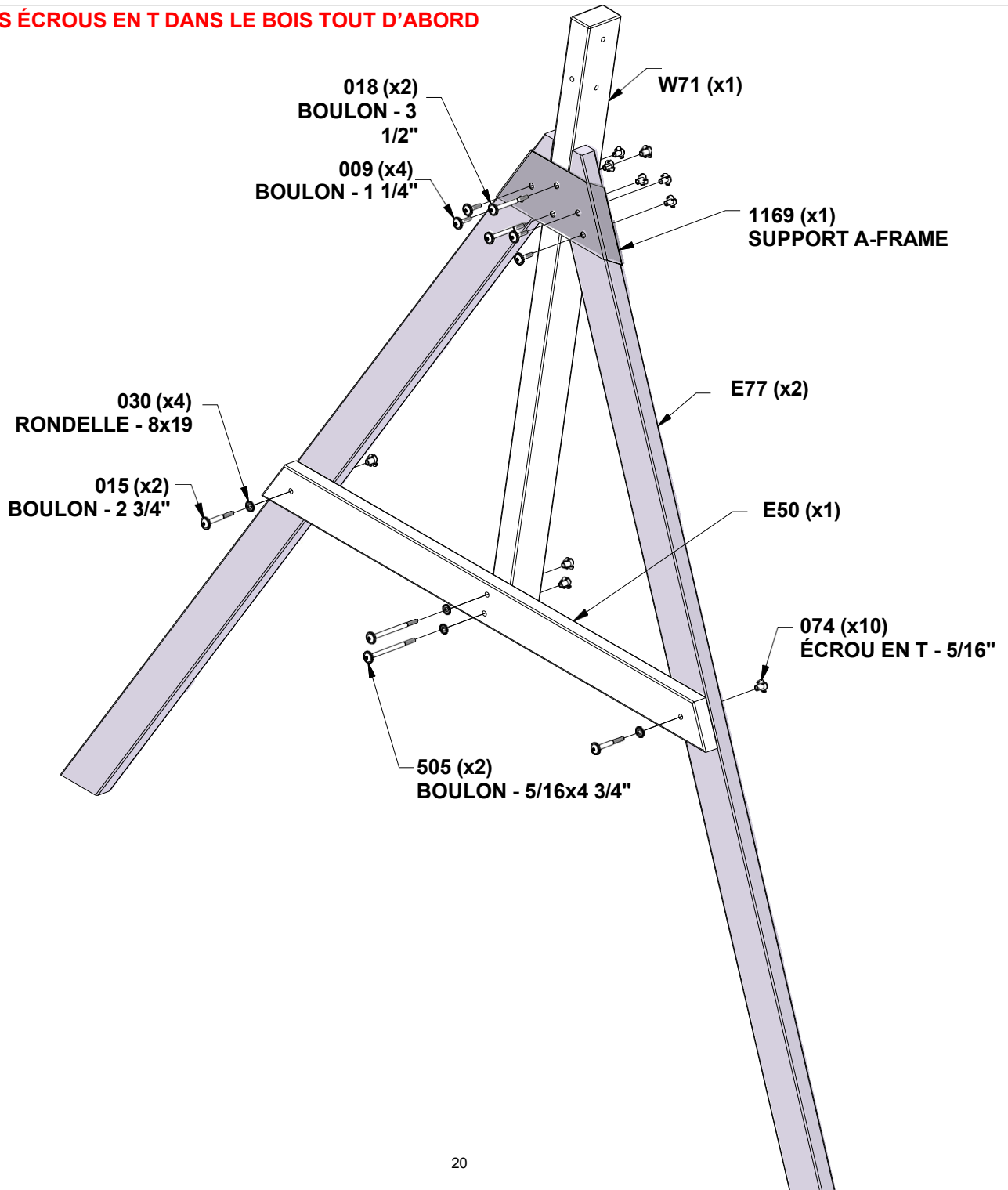

ÉTAPE 3 - POUTRE DE BALANÇOIRE



ASSEMBLAGE DE POUTRE

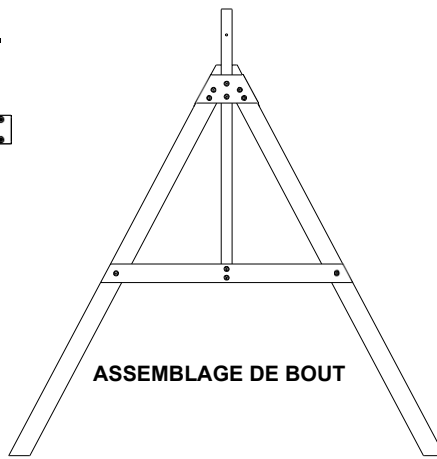

ASSEMBLAGE DE BOUT

QTÉ	N° DE PIÈCE	DESCRIPTION
2	H100005	ÉCROU EN BARILLET WH 5/16x7/8
1	H100006	ÉCROU EN BARILLET WH 5/16x1 1/2
2	H100011	BOULON WH 5/16x1 3/4

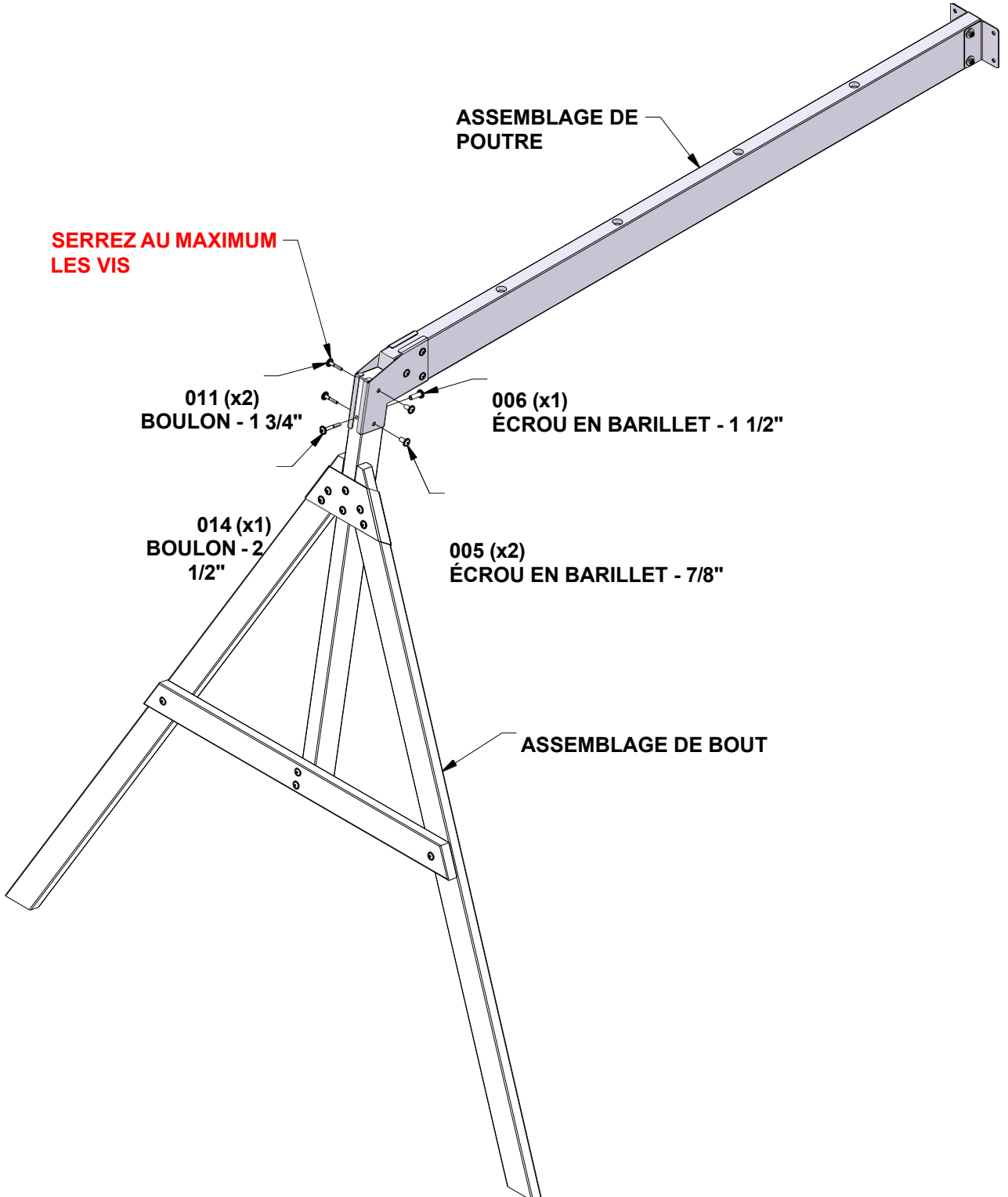

ÉTAPE 4 - POUTRE DE BALANÇOIRE

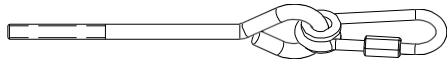

H100099 9 1/2" PORTE-BALANÇOIRE QUICK LINK
(x4)

QTÉ	N° DE PIÈCE	DESCRIPTION
4	H100103	RONDELLE DE SÉCURITÉ 17x30
4	H100105	RONDELLE PLATE 8x27
4	H100110	ÉCROU D'ARRÊT 5/16

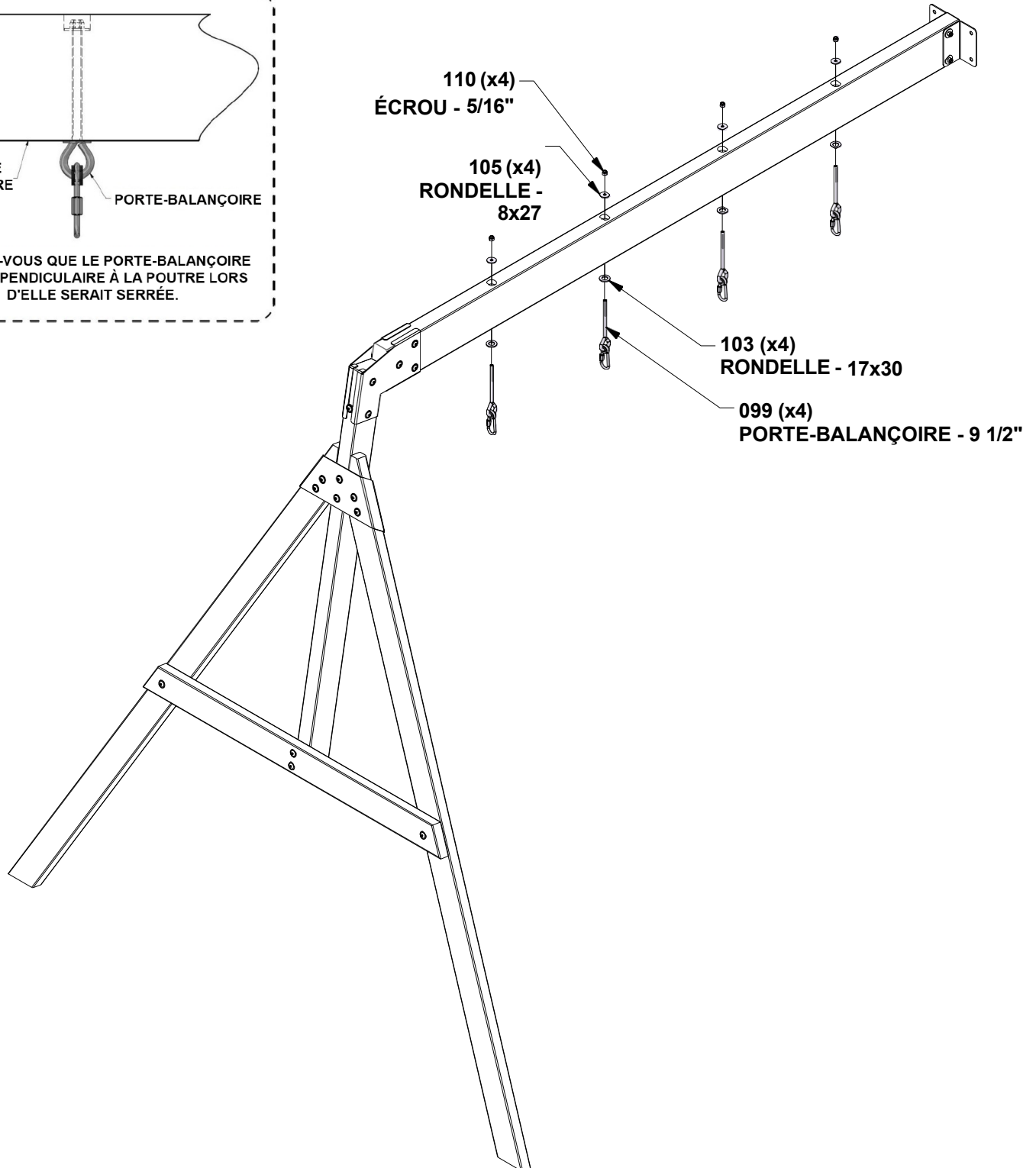
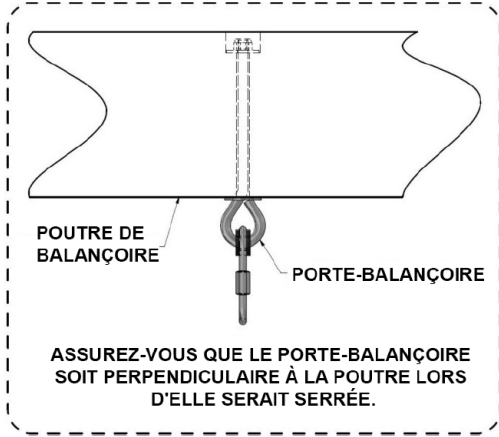

ÉTAPE 1 - ASSEMBLAGE DE TOBOGGAN



A6P00325

(x1) SIÈGE DU TOBOGGAN DK.VERTE



M77 SUPPORT À TOBOGGAN-

(x1) W4L12363 5/8"x3 3/8"x14 1/4"
(16x86x362)

QTÉ	N° DE PIÈCE	DESCRIPTION
2	H100074	ÉCROU EN T 5/16
2	H100115	BOULON WH 5/16x1/2

UTILISEZ LE SUPPORT À TOBOGGANS M77 COMME NIVEAU AFIN DE FORER LES TROUS EN BAS DU SIÈGE DU TOBOGGAN. ASSUREZ-VOUS DE METTRE EN PLACE LE SUPPORT À TOBOGGAN À 1/2" [13 MM] DU BORD INFÉRIEUR DU SIÈGE AVANT DE CALQUER LE MOTIF DES TROUS. UTILISEZ UNE MÈCHE À 3/8" [10 MM] AFIN DE FOREZ LE MOTIF DES

HAUT

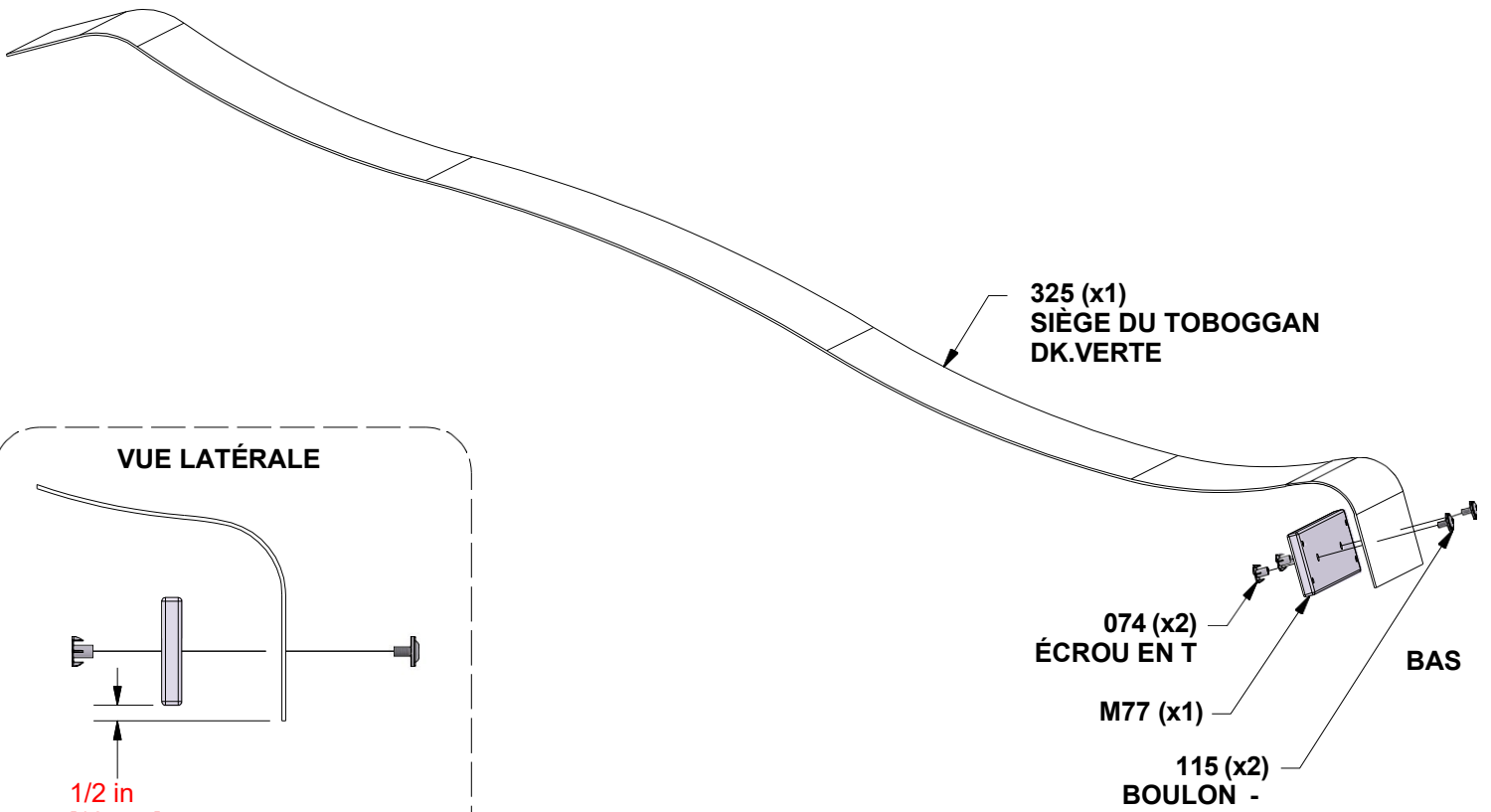

VUE LATÉRALE

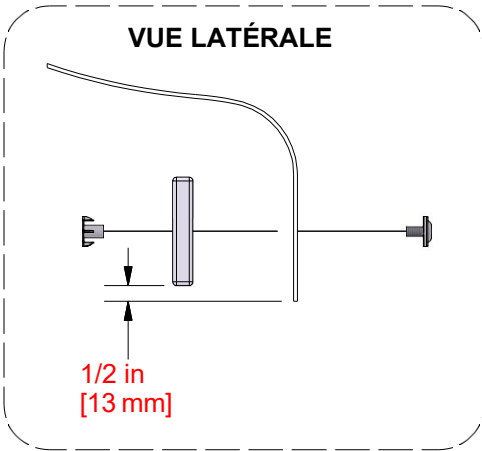

IL EST RECOMMANDÉ DE PRÉPLIER LES BOUTS AFIN DE FACILITER L'ASSEMBLAGE. PLACEZ LE SIEGE AU SOLEI AFIN DE FACILITER LA FLEXION.

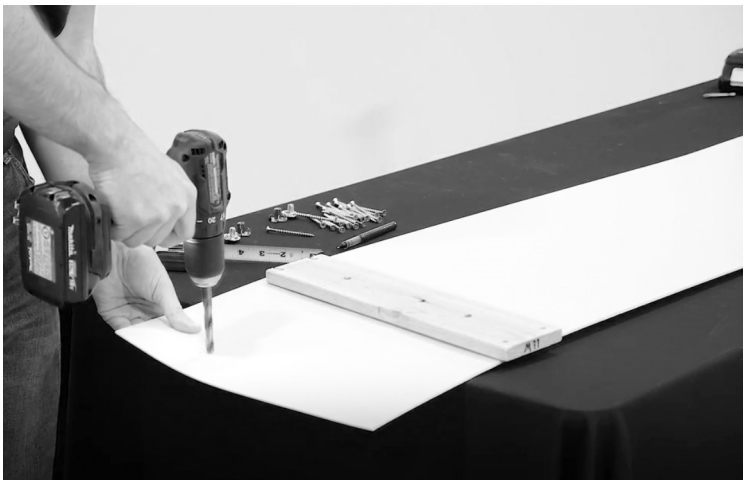

ÉTAPE 2 - ASSEMBLAGE DE TOBOGGAN

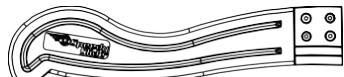

A6P00102 RAIL SUPÉRIEUR DU TOBOGGAN GAUCHE (x1)

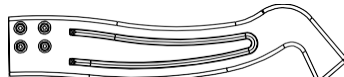

A6P00103 RAIL INFÉRIEUR DU TOBOGGAN GAUCHE (x1)



A6P00105 RAIL INFÉRIEUR DU TOBOGGAN DROIT (x1)

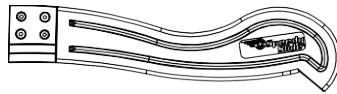

A6P00104 RAIL SUPÉRIEUR DU TOBOGGAN DROIT (x1)

QTÉ	N° DE PIÈCE	DESCRIPTION
8	H100005	ÉCROU EN BARILLET WH 5/16x7/8
8	H100031	RONDELLE D'ARRÊT EXT

RÉPÉTEZ SUR L'AUTRE CÔTÉ EN FAISANT UN ASSEMBLAGE DE GAUCHE ET DROIT.

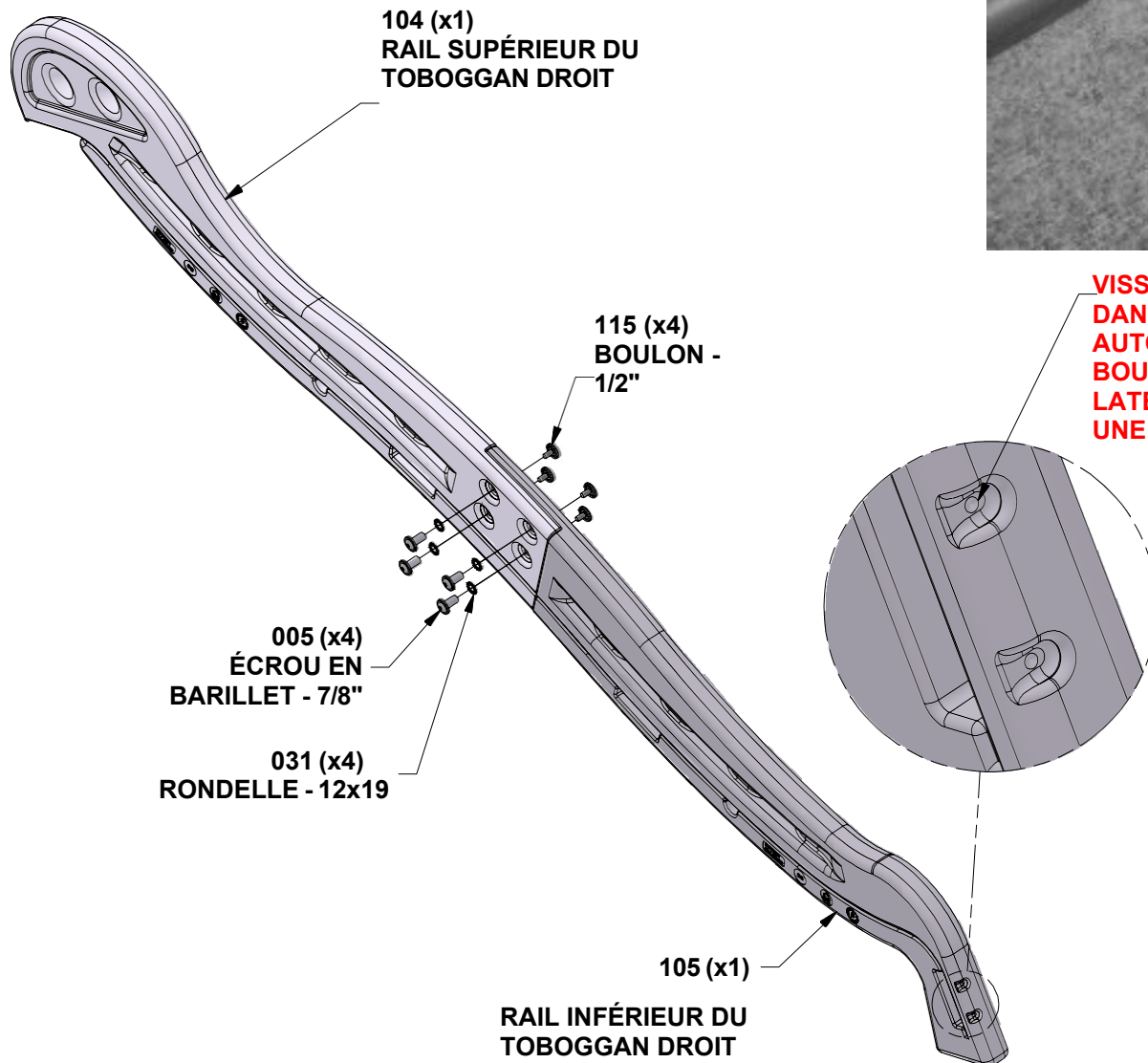

VISSEZ DES TROUS PILOTES DANS TOUS LES RIDES AUTOUR LE BAS ET LES BOUTS DES RAILS LATÉRALES EN UTILISANT UNE MÈCHE À 3MM

ÉTAPE 3 - ASSEMBLAGE DE TOBOGGAN



M78 SUPPORT À TOBOGGAN DU
(x2) CENTRE- W4L12362 5/8"x3 3/8"x14
1/4" (16x86x362)

**METTES UN ASSEMBLAGE DE RAIL SUR UNE SURFACE PLATE ET COMMENCER D'INSÉRER LE SIÈGE DU TOBOGGAN VERS LE BAS DU RAIL.
AYEZ L'AIDE D'UN ADULTE PLIER LE RAIL VERS LE HAUT DU TOBOGGAN ET INSÉRER LE SIÈGE DANS LA CAVITÉ.
ASSUREZ-VOUS QUE LE SIÈGE DU TOBOGGAN EST COMPLÈTEMENT SITUÉ DANS LA CAVITÉ DU TOBOGGAN.
INSTALLEZ LES DEUX M78 SUPPORTS À TOBOGGAN DU CENTRE AUX LIEUX INDICÉS AU-DESSOUS. (FIG 2)**

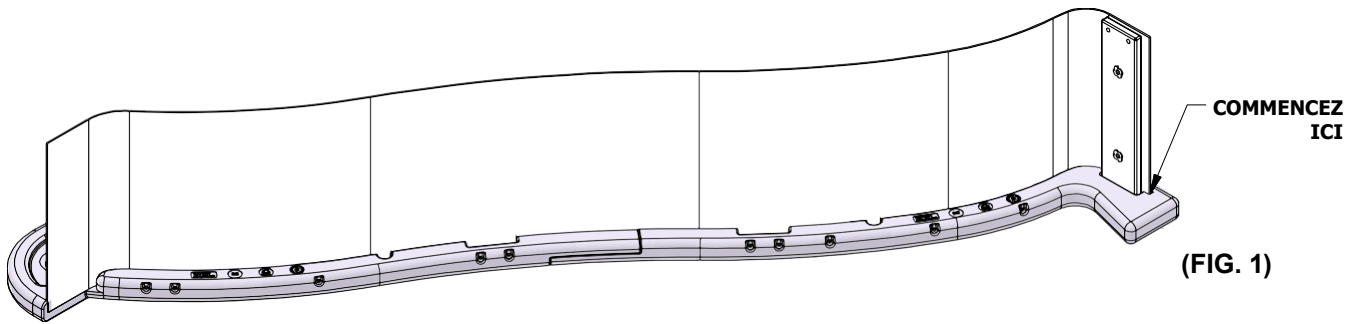

(FIG. 1)

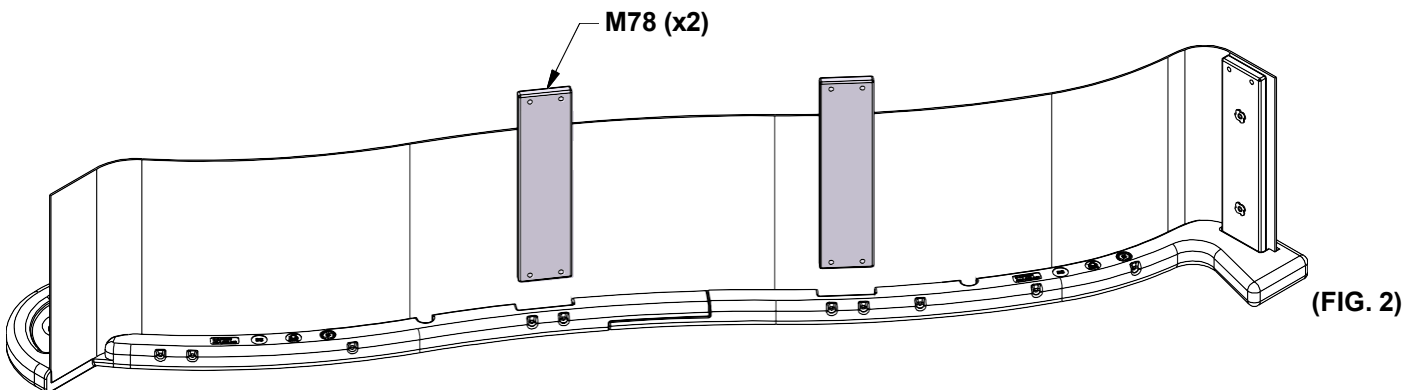

(FIG. 2)



ÉTAPE 4 - ASSEMBLAGE DE TOBOGGAN

QTÉ	N° DE PIÈCE	DESCRIPTION
24	H100090	VIS PFH 8x2 1/2

DÈS QUE LE SIÈGE DU TOBOGGAN, AND PLANCHE DE SONT COMPLÈTEMENT DANS LA CAVITÉ ET POCHE DE SUPPORT, VEUILLEZ SÉCURISER EN UTILISANT UNE VIS À CHAQUE TROU PILOT COMME MONTRÉ. RÉPÉTEZ LE PROCESSUS SUR L'AUTRE CÔTÉ



LE FAIT DE NE PAS INSÉRER CORRECTEMENT LE SIÈGE DU TOBOGGAN PEUT ENTRAÎNER DES BLESSURES OU UNE AMPUTATION. LES BORDS EXPOSÉS DES GLISSIÈRES PEUVENT ÊTRE COUPANTS ET DEVENIR RISQUE DE LACÉRATION SI LA GLISSIÈRE N'EST PAS CORRECTEMENT ASSEMBLÉE

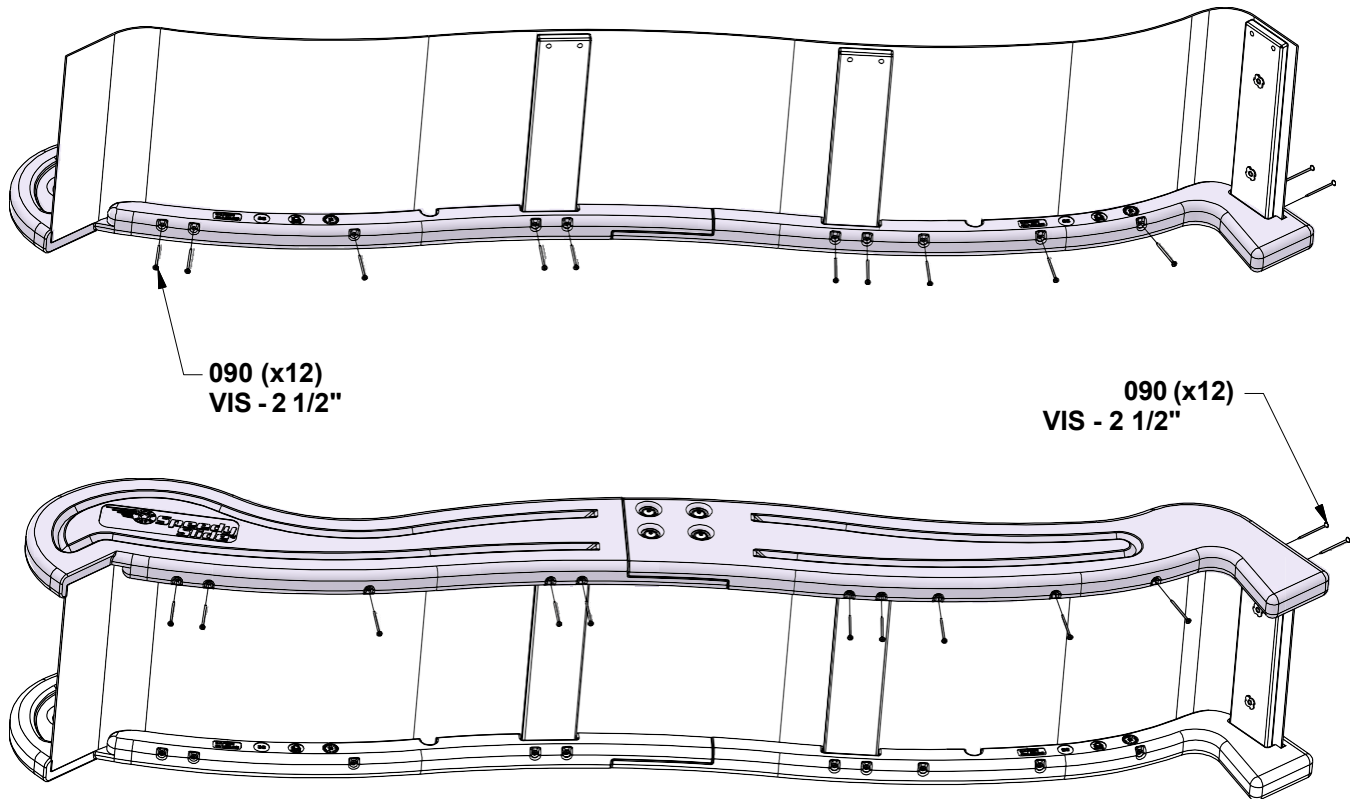

UTILISEZ UN MAILLOT EN CAOUTCHOUC AFIN D'INSÉRER AU FOND DANS LA CAVITÉ DE TOBOGGAN.

ÉTAPE 1 - ASSEMBLAGE DE FORT

QTÉ	N° DE PIÈCE	DESCRIPTION
10	H100072	ÉCROU EN T 1/4
10	H100138	RONDELLE D'ARRÊT EXT 6x15
8	H100160	BOULON WH 1/4x2
2	H100566	BOULON WH 1/4x2-1/4

ES01 MONTANT - W4L19854
(x1) 1 1/8"x3 3/8"x81 3/4" (30x86x2076)

ES04 MONTANT - W2A04227
(x1) 1 1/8"x3 3/8"x81 3/4" (30x86x2076)

ES07 RAIL MURAL - W4L19858
(x1) 1 1/8"x3"x57 3/8" (30x76x1457)

H03 PLANCHE DE SOL -
(x1) W4L19870 1"x3"x69"
(24x76x1752)

HS13 PLANCHE DE SUPPORT -
(x1) W4L19872 3/4"x3"x40 3/4"
(20x76x1034)

**INSTALLEZ LES ÉCROUS EN T DANS
LE BOIS TOUT D'ABORD**

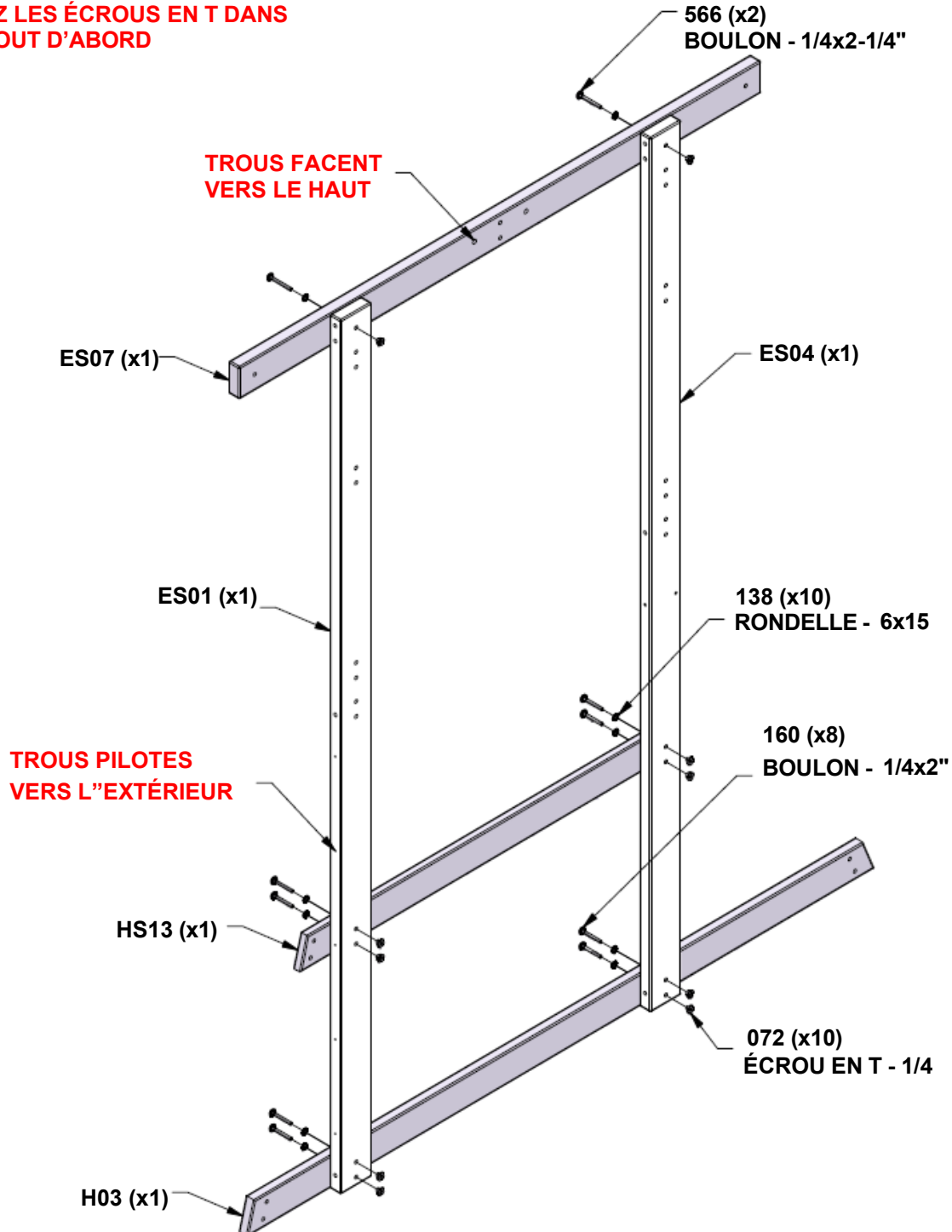

ÉTAPE 2 - FORT



ES05 BILLOT À SOL - W4L19907
(x2) 1 1/8"x3 3/8"x3" (30x86x76)

QTÉ	N° DE PIÈCE	DESCRIPTION
4	H100072	ÉCROU EN T 1/4
4	H100138	RONDELLE D'ARRÊT EXT 6x15
4	H100757	BOULON WH 1/4x3



HS10 SUPPORT AU SOL -
(x1) W4L19867 3/4"x3"x42 1/2"
(20x76x1079)

INSTALLEZ LES ÉCROUS EN T DANS LE BOIS TOUT D'ABORD

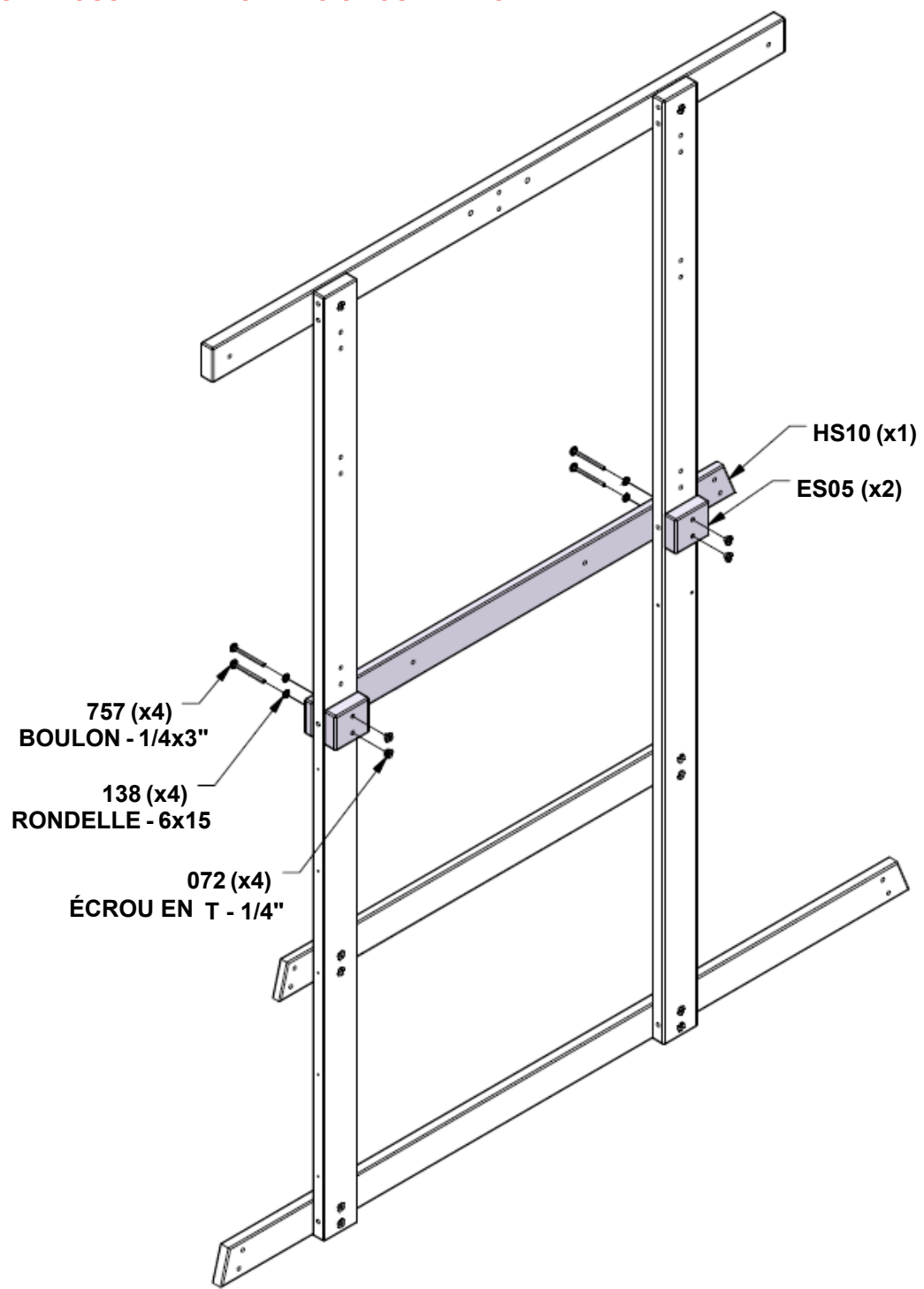

ÉTAPE 3 - FORT

QTÉ	N° DE PIÈCE	DESCRIPTION
8	H100072	ÉCROU EN T 1/4
8	H100138	RONDELLE D'ARRÊT EXT 6x15
4	H100160	BOULON WH 1/4x2

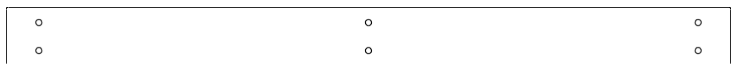

HS20 PLANCHE MURALE -
(x1) W4L19898 3/4"x3"x37 1/2"
(20x76x951)

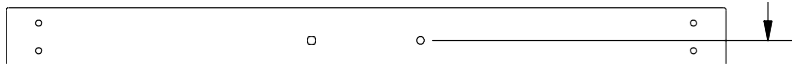

ES06 RAIL DE POUTRE DE
(x1) BALANÇOIRE - W4L19862 1
1/8"x3"x37 1/2" (30x76x951)

1 3/8 in
[34 mm]

INSTALLEZ LES ÉCROUS EN T DANS LE BOIS TOUT D'ABORD

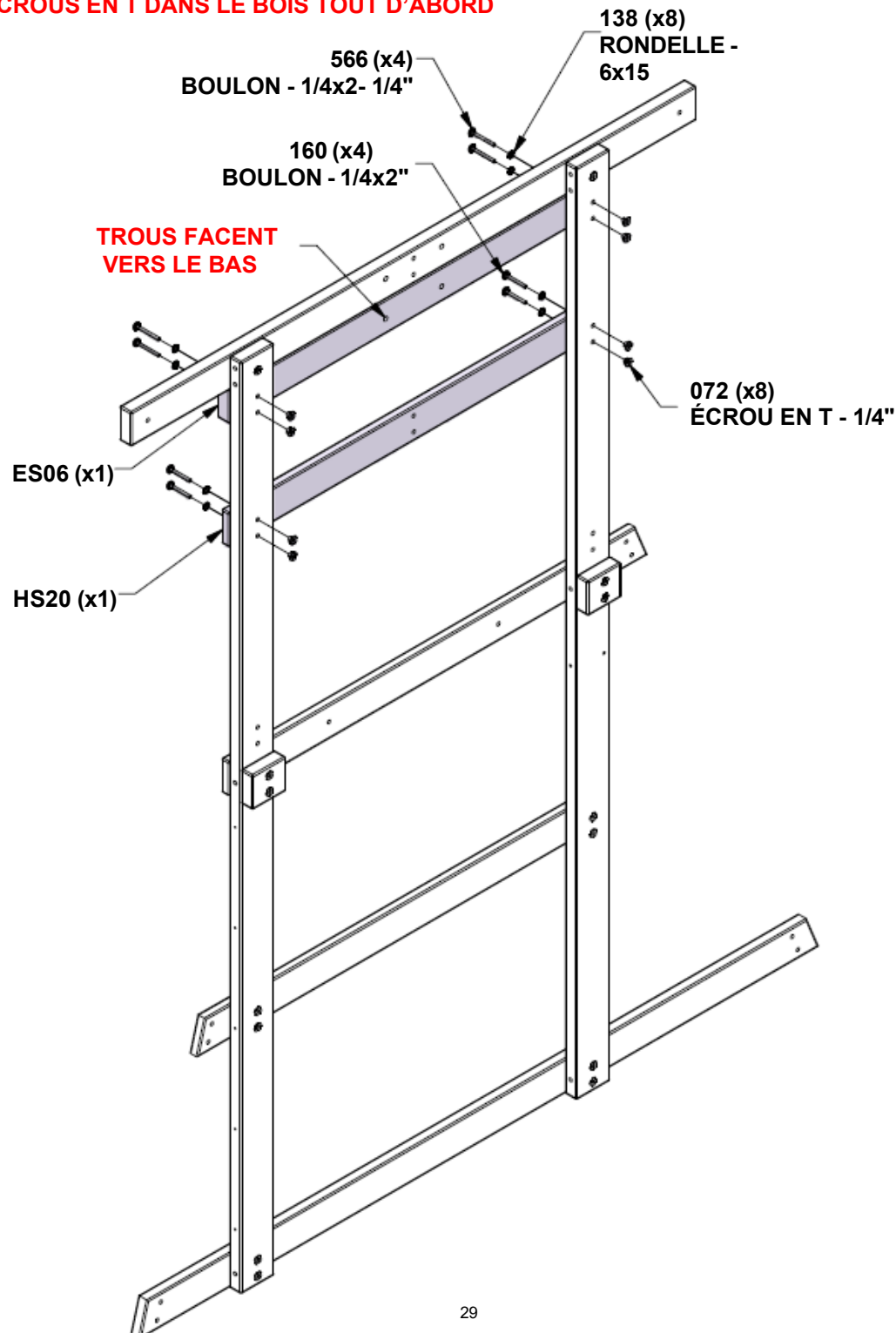

ÉTAPE 4 - FORT

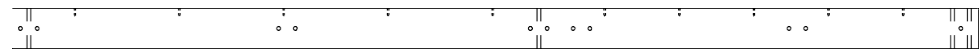

ES02 MONTANT - W4L19855
(x1) 1 1/8"x3 3/8"x81 3/4" (30x86x2076)



ES03 MONTANT - W4L19856
(x1) 1 1/8"x3 3/8"x81 3/4" (30x86x2076)



H01 PLANCHE DE SOL - W4L19890
(x1) 1"x3"x37 1/2" (24x76x951)

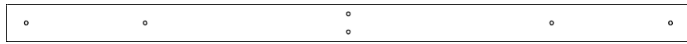

HS04 RAIL DE TOIT - W4L19859
(x1) 3/4"x3"x57 3/8" (20x76x1457)

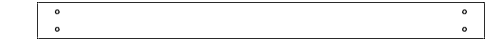

HS15 PLANCHE MURALE - W4L19884
(x1) 3/4"x3"x37 1/2" (20x76x951)

ES05 BILLOT À SOL - W4L19907
(x2) 1 1/8"x3 3/8"x3" (30x86x76)

QTÉ	N° DE PIÈCE	DESCRIPTION
10	H100072	ÉCROU EN T 1/4
10	H100138	RONDELLE D'ARRÊT EXT 6x15
6	H100160	BOULON WH 1/4x2

INSTALLEZ LES ÉCROUS EN T DANS LE BOIS TOUT D'ABORD

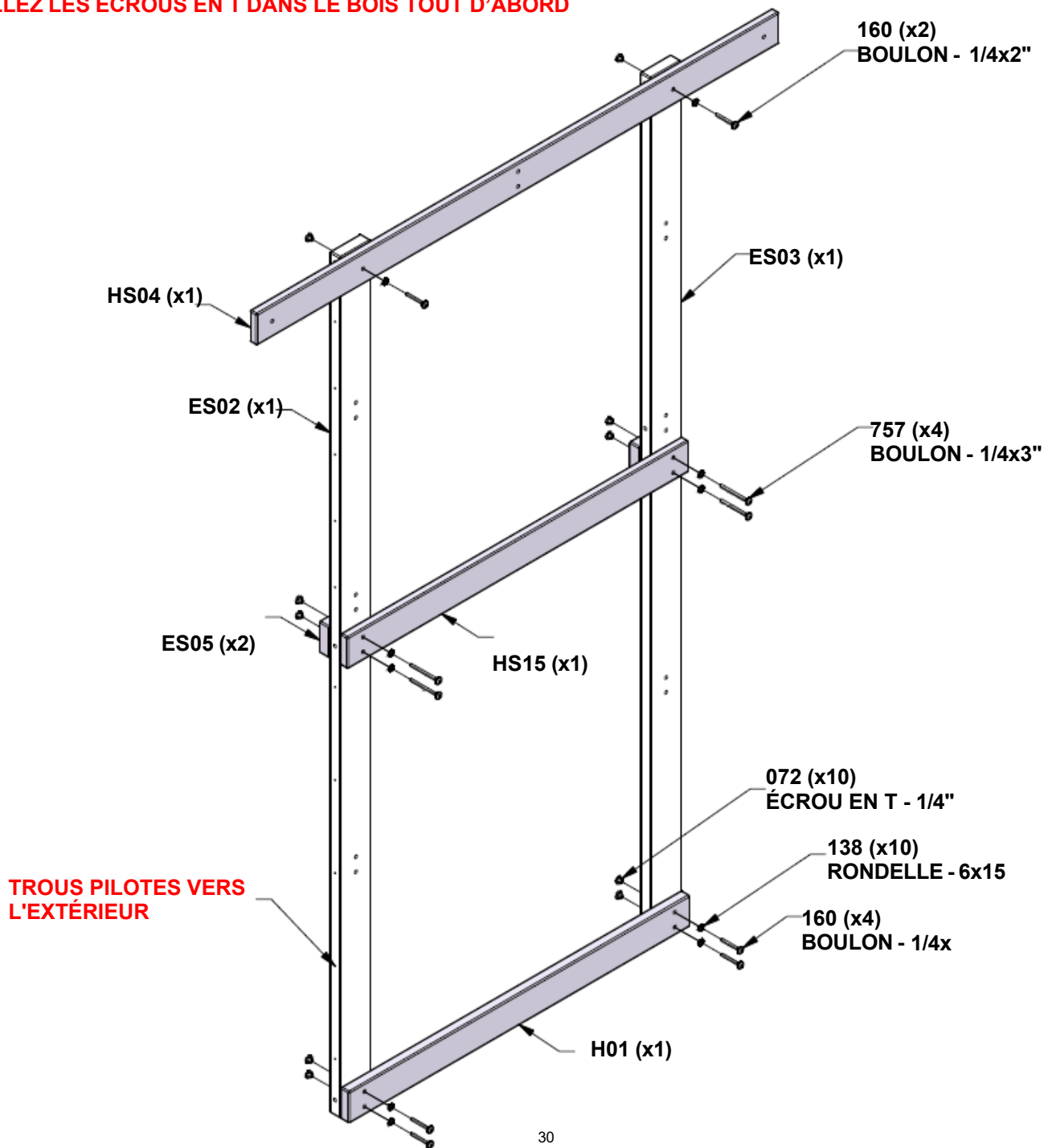

ÉTAPE 5 - FORT

QTÉ	N° DE PIÈCE	DESCRIPTION
8	H100072	ÉCROU EN T 1/4
8	H100138	RONDELLE D'ARRÊT EXT 6x15

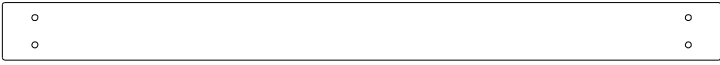

HS15 PLANCHE MURALE - W4L19884
(x1) 3/4"x3"x37 1/2" (20x76x951)



HS17 PLANCHE MURALE - W4L19883
(x1) 3/4"x3"x37 1/2" (20x76x951)

INSTALLEZ LES ÉCROUS EN T DANS LE BOIS TOUT D'ABORD

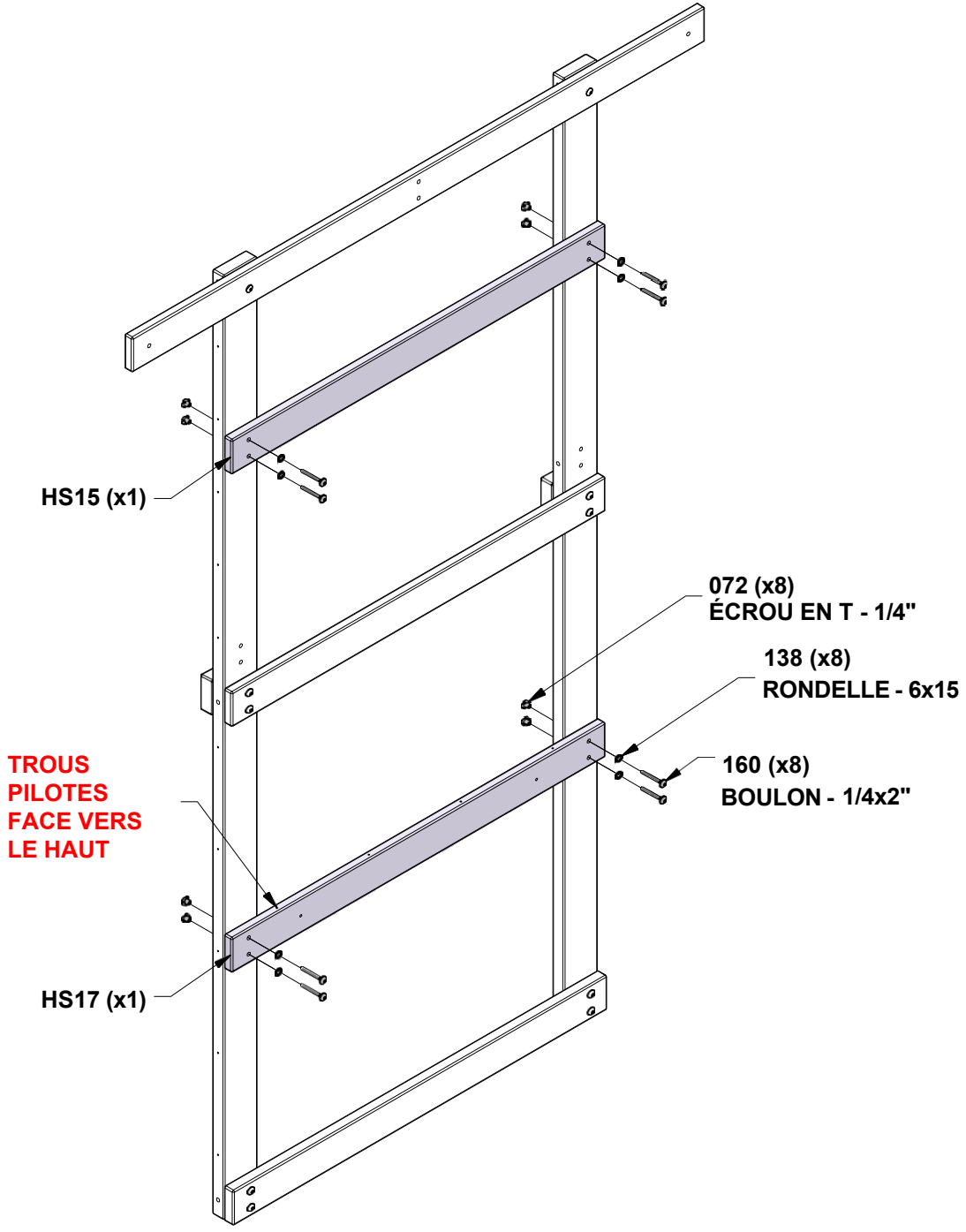

ÉTAPE 6 - FORT



H02 PLANCHE DE SOL - W4L19892
(x2) 1"x3"x37 1/2" (24x76x951)



HS07 PLANCHE DE TOIT - W4L19879
(x2) 3/4"x3"x37 1/2" (20x76x951)

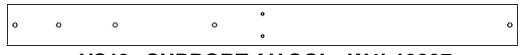

HS18 SUPPORT AU SOL - W4L19897
(x1) 3/4"x3"x37 1/2" (20x76x951)

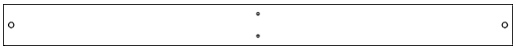

HS22 SUPPORT AU SOL - W4L19885
(x1) 3/4"x3"x37 1/2" (20x76x951)

QTÉ	N° DE PIÈCE	DESCRIPTION
16	H100072	ÉCROU EN T 1/4
16	H100138	RONDELLE D'ARRÊT EXT 6x15

INSTALLEZ LES ÉCROUS EN T DANS LE BOIS TOUT D'ABORD

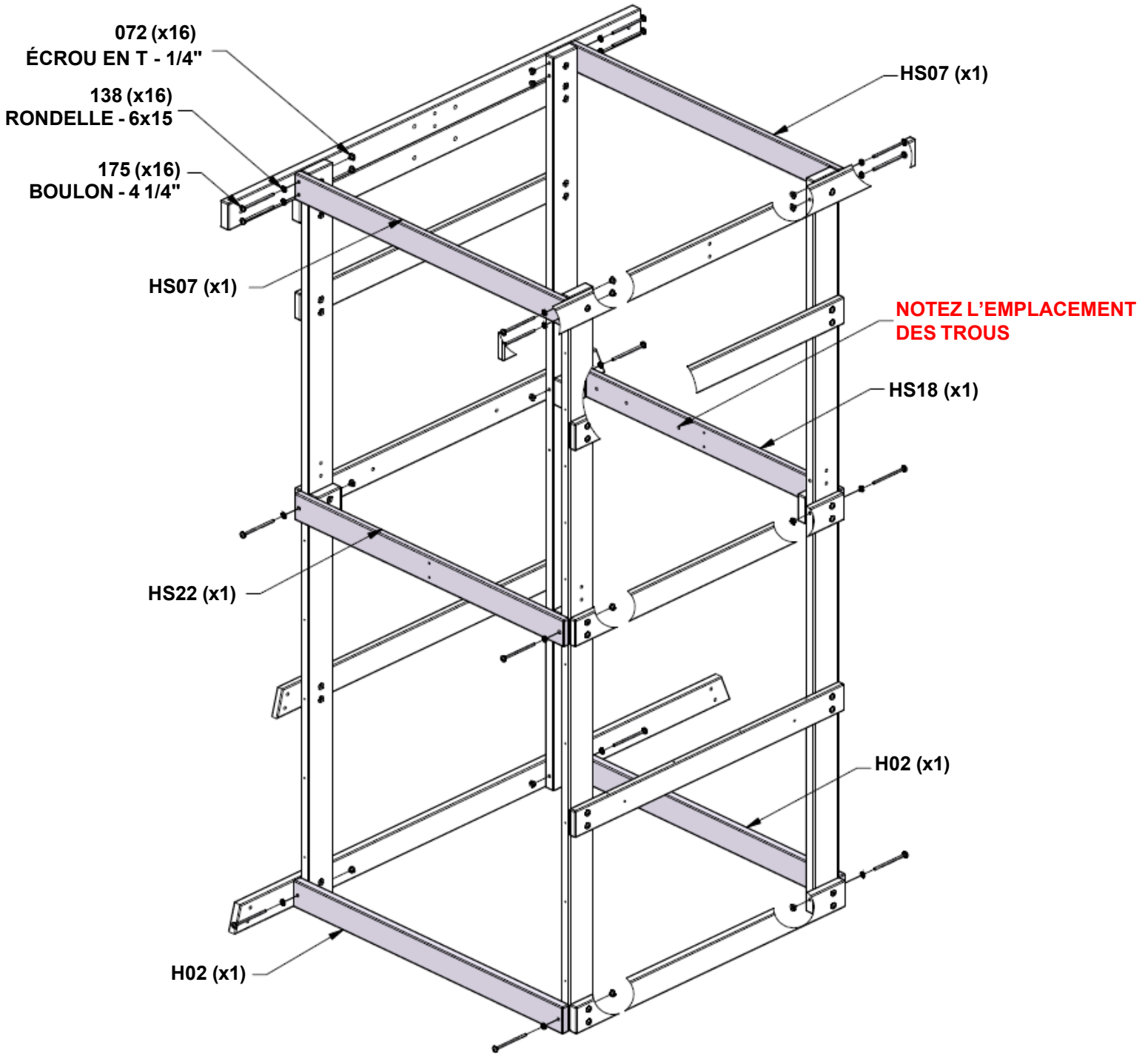

ÉTAPE 7 - FORT



FS01 SUPPORT À L'ANGLE - W4L19857
(x3) 1 1/8"x2 3/8"x13" (30x60x330)



HS03 SOLIVE DE SOL - W4L19860
(x1) 3/4"x3"x37 1/2" (20x76x951)

QTÉ	N° DE PIÈCE	DESCRIPTION
3	H100072	ÉCROU EN T 1/4
4	H100090	VIS PFH 8x2 1/2
6	H100138	RONDELLE D'ARRÊT EXT 6x15
1	H100146	TIREFOND WH 1/4x2
3	H100160	BOULON WH 1/4x2

**INSTALLEZ LES ÉCROUS EN T
DANS LE BOIS TOUT
D'ABORD ALIGNEZ LES
TROUS PILOTES**

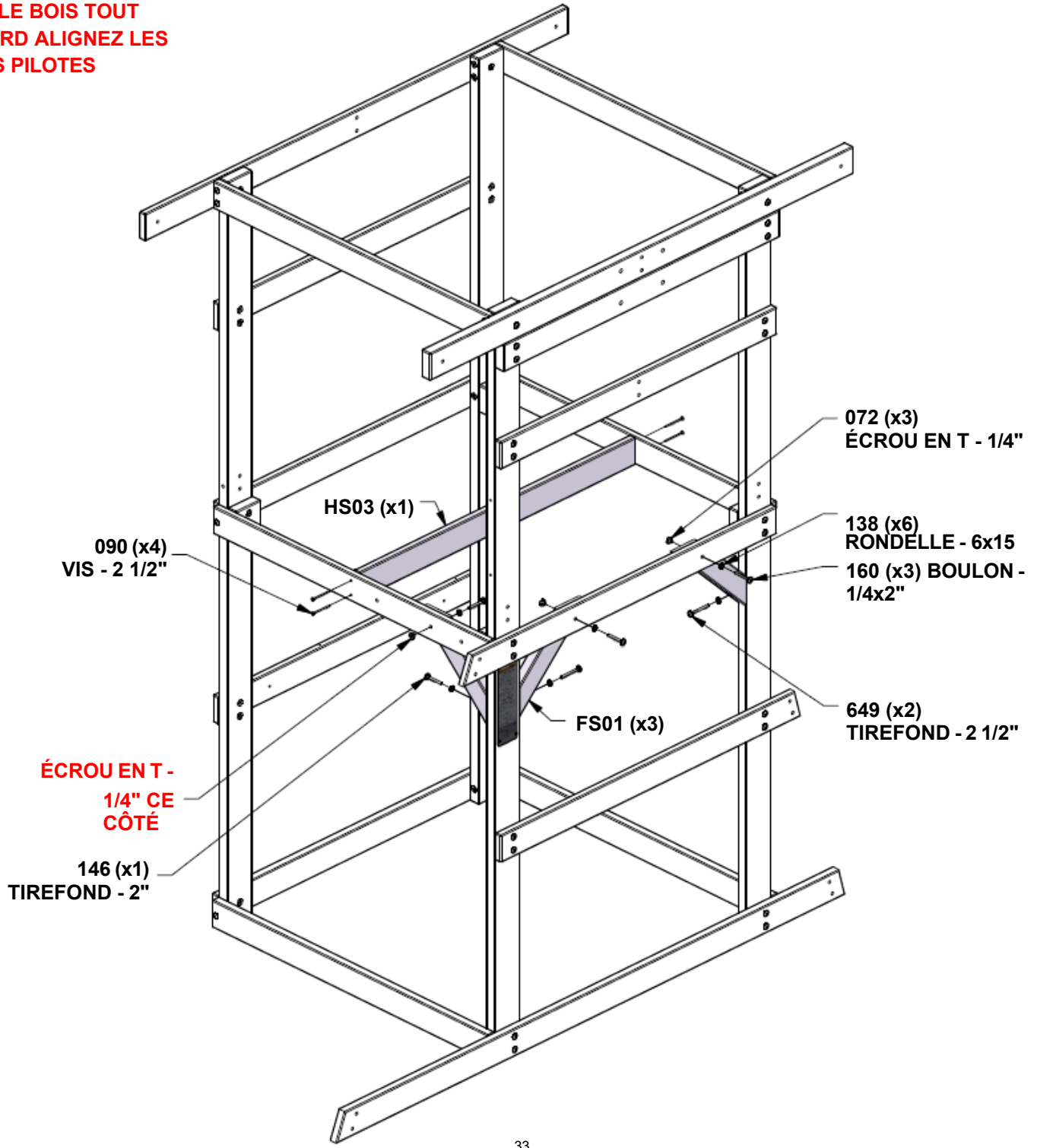

ÉTAPE 8 - FORT

QTÉ	N° DE PIÈCE	DESCRIPTION
59	H100086	VIS PFH 8x1-1/2

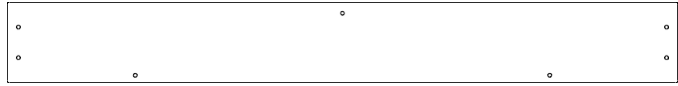

L01 PLANCHER - W4L19906
(x2) 5/8"x4 1/8"x35" (16x106x890)

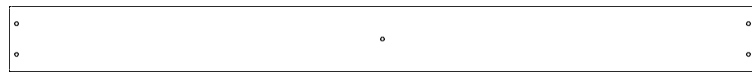

M02 PLANCHER - W4L19843
(x9) 5/8"x3 3/8"x39" (16x86x991)

ESPACEZ LES PLANCHERS UNIFORMÉMENT

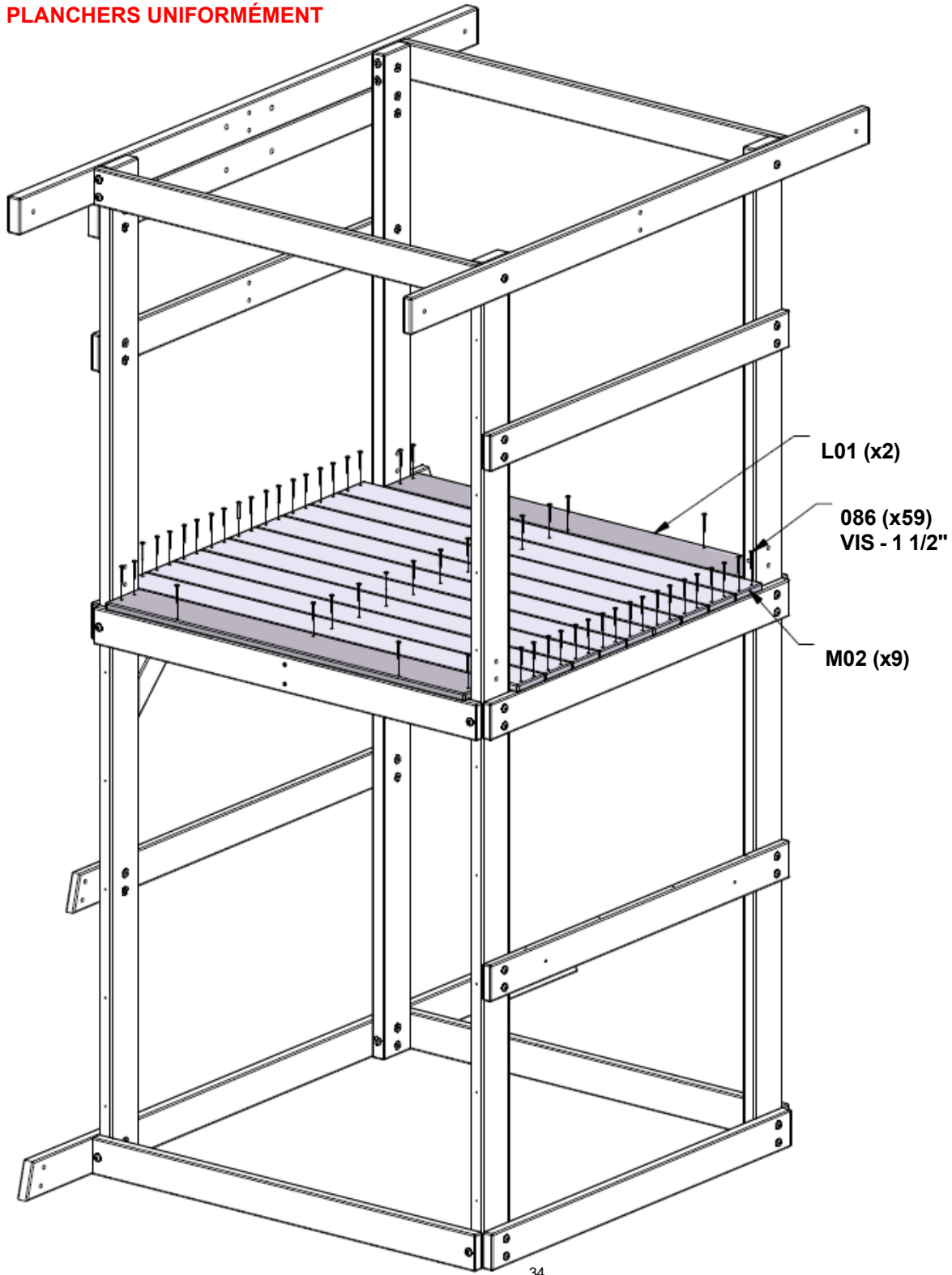

ÉTAPE 9 - FORT

QTÉ	N° DE PIÈCE	DESCRIPTION
8	H100086	VIS PFH 8x1-1/2



N06 PLANCHE MURALE - W4L19864
(x2) 5/8"x2 3/8"x18 3/4" (16x60x477)

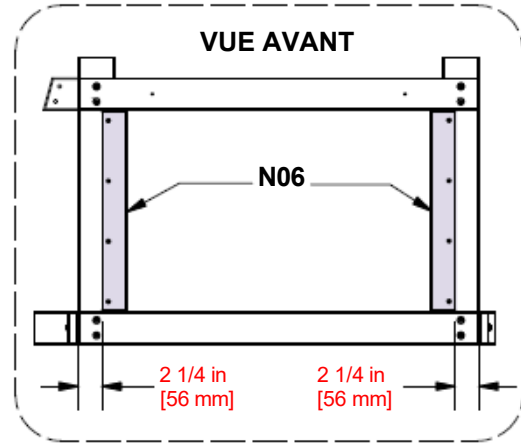
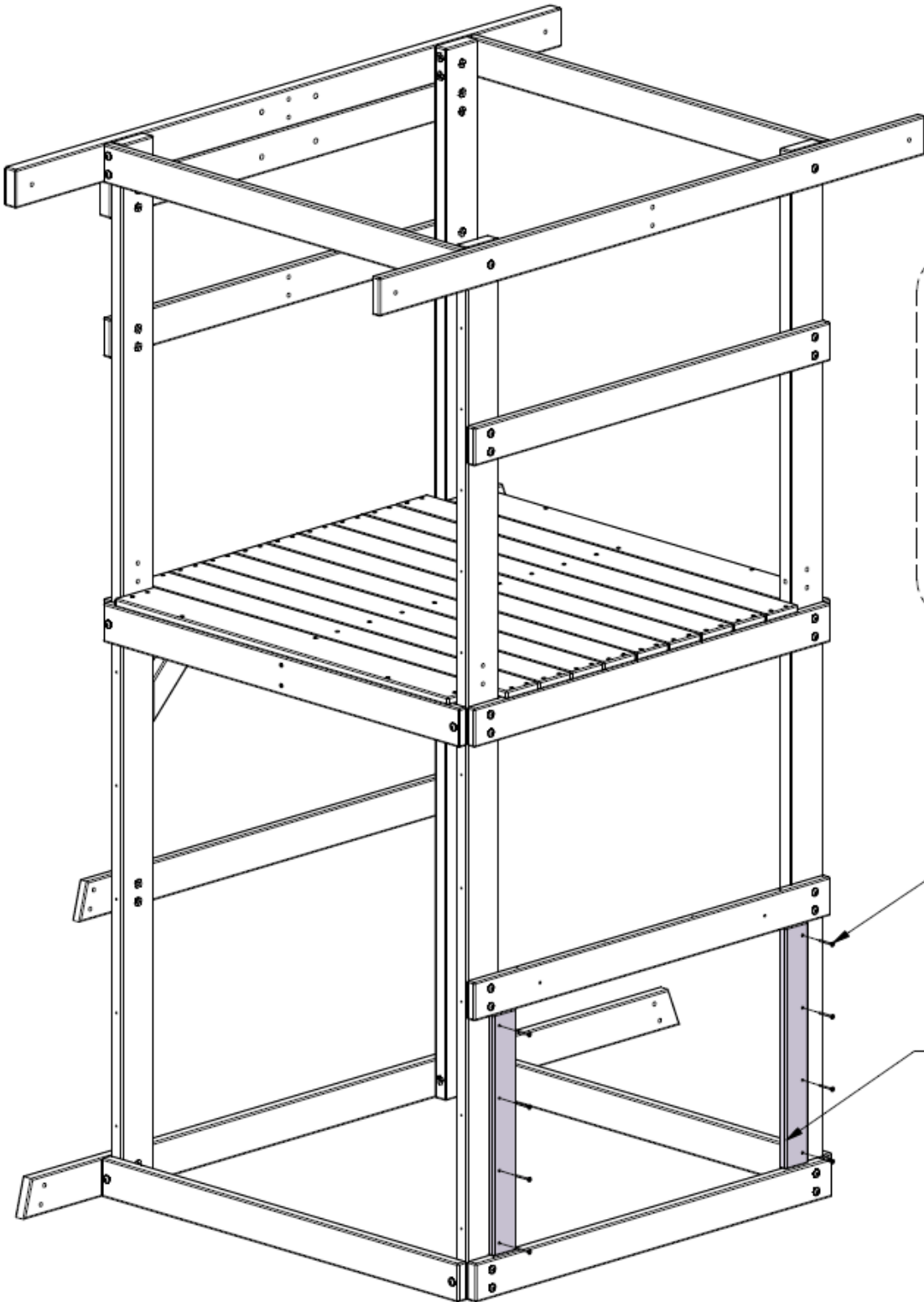

086 (x8)
VIS - 1 1/2"

N06 (x2)

ÉTAPE 10 - FORT

QTÉ	N° DE PIÈCE	DESCRIPTION
2	H100090	VIS PFH 8x2 1/2

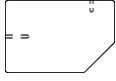

HS09 SUPPORT D'ÉTAGÈRE - W4L19866
(x2) 3/4"x3"x4 1/2" (20x76x114)

ALIGNER LES TROUS PILOTES

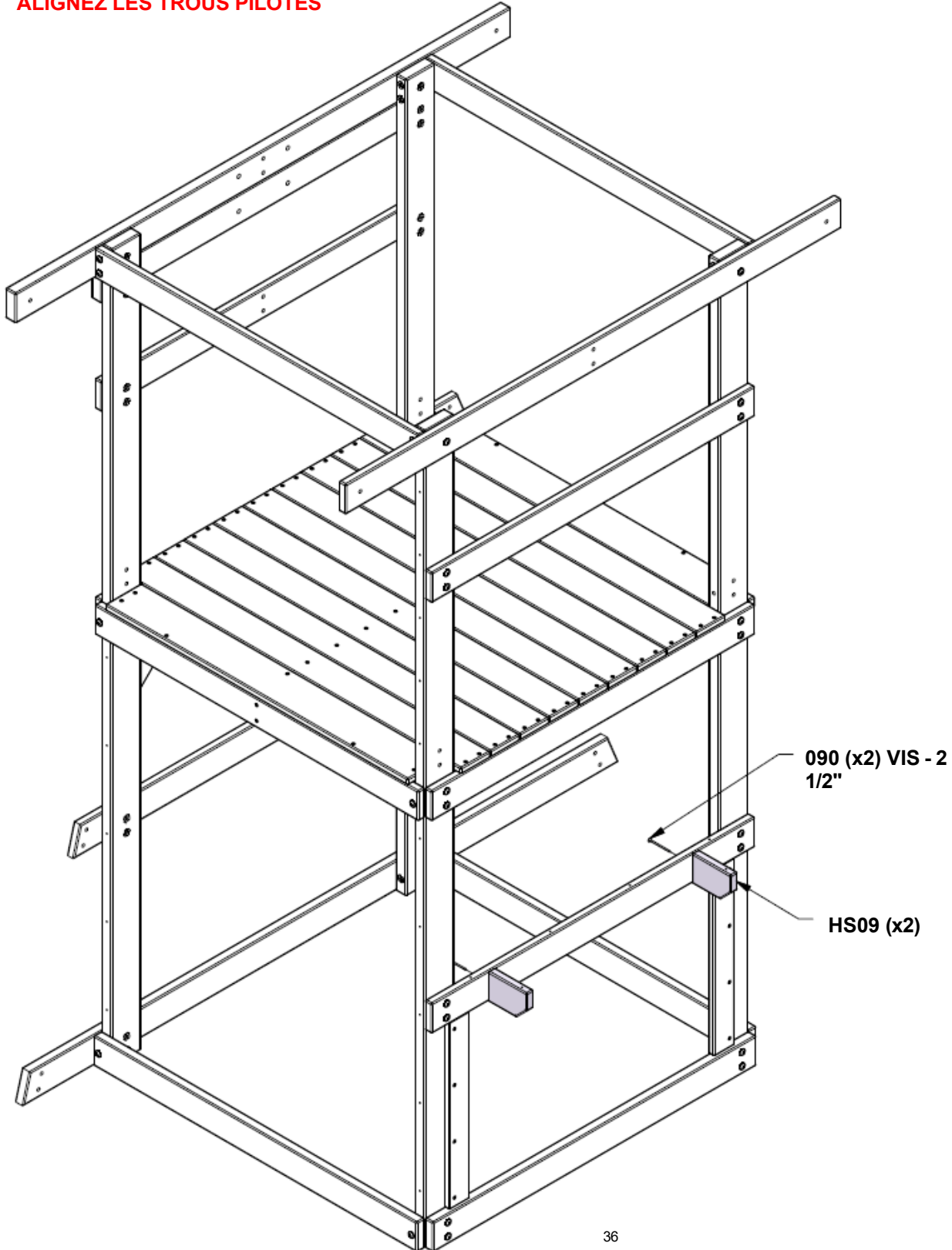

ÉTAPE 11 - FORT

QTÉ	N° DE PIÈCE	DESCRIPTION
17	H100085	VIS PFH 8x1



KK01 PLANCHE MURALE - W4L19876
(x7) 1/2"x3 1/2"x30 5/8" (11.9x88.9x778)

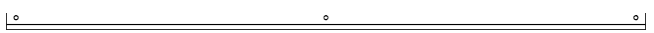

KK02 PLANCHE MURALE - W4L19875
(x1) 1/2"x7/8"x30 5/8" (11.9x22.9x778)

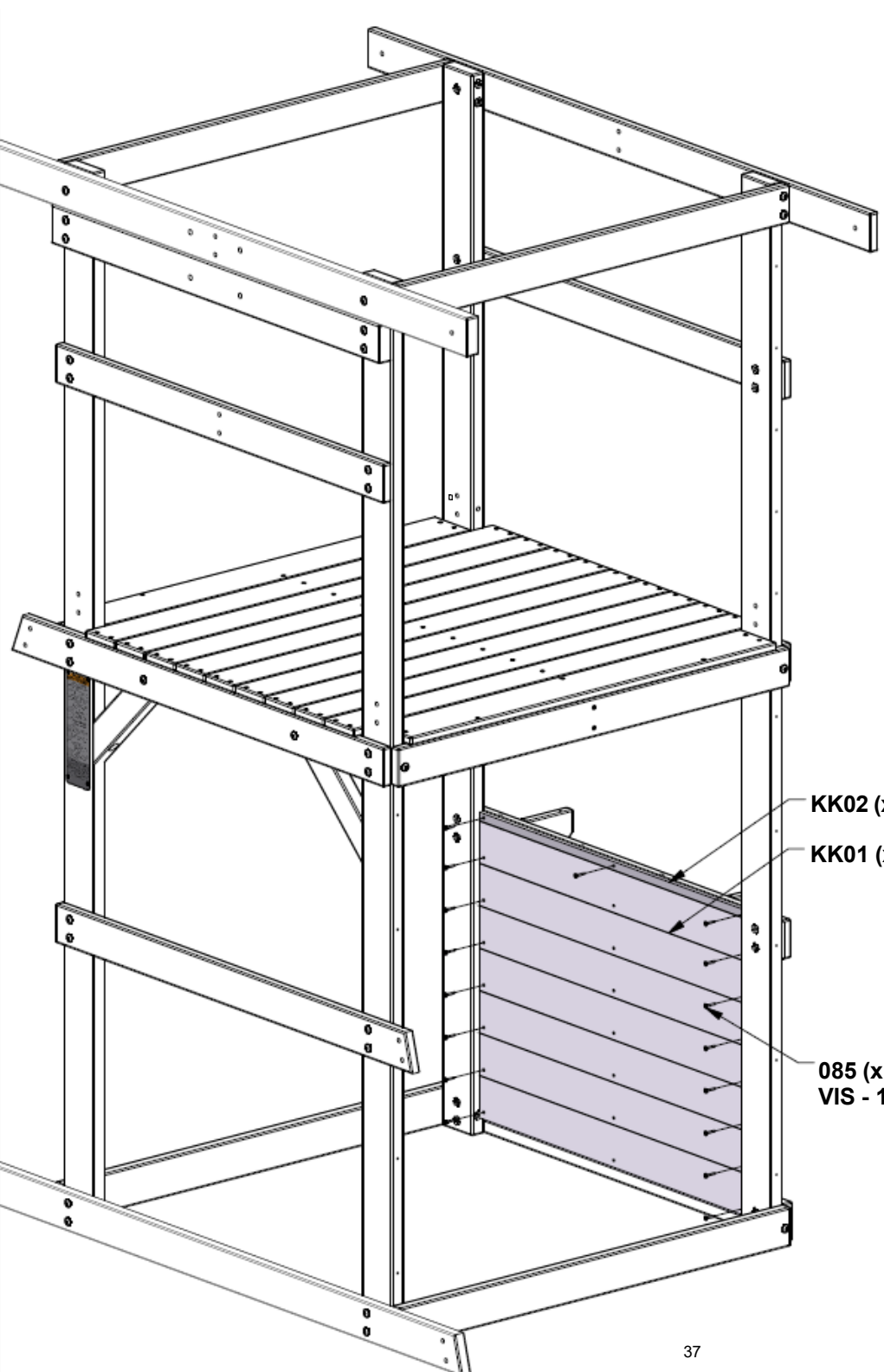

- KK02 (x1)
- KK01 (x7)
- 085 (x17)
VIS - 1"

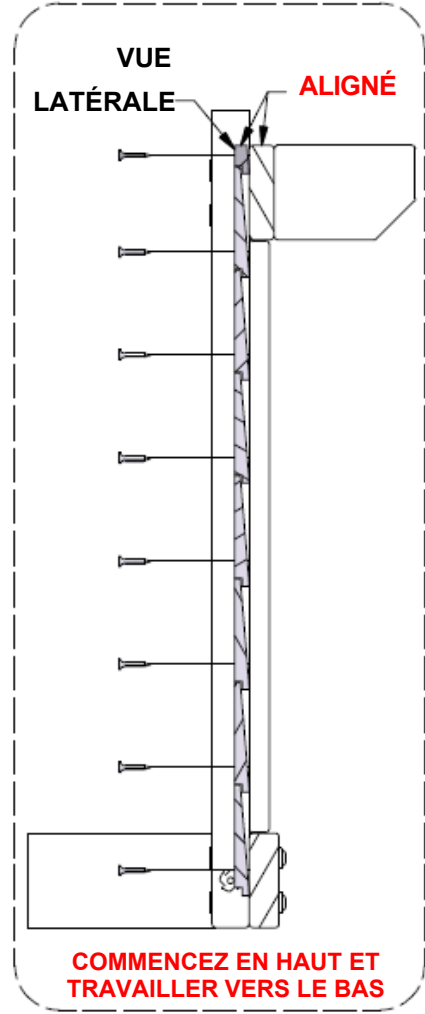

ÉTAPE 12 - FORT

QTÉ	N° DE PIÈCE	DESCRIPTION
7	H100085	VIS PFH 8x1

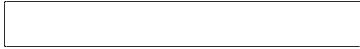

N07 PLANCHE MURALE - W4L19865
(x1) 5/8"x2 3/8"x18 3/4" (16x60x477)

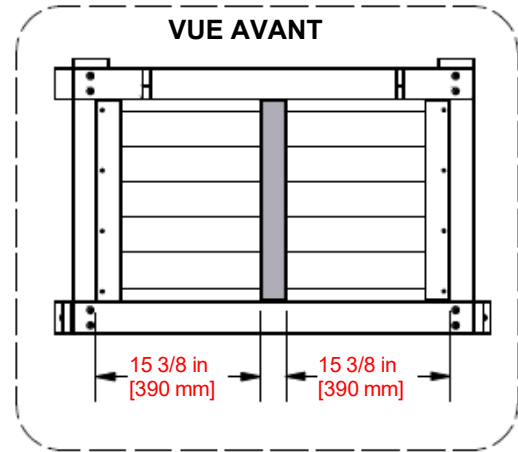
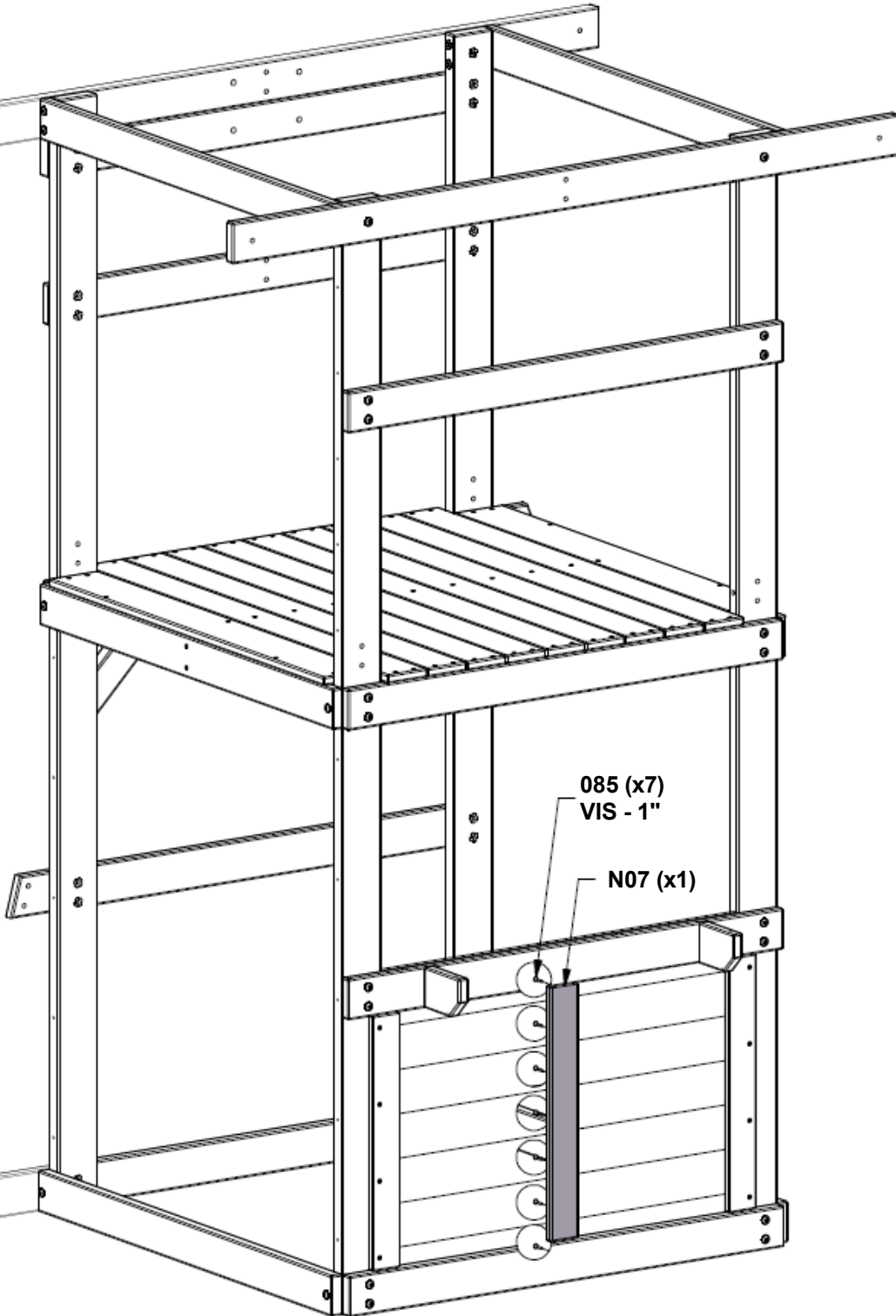

ÉTAPE 13 - FORT

QTÉ	N° DE PIÈCE	DESCRIPTION
6	H100086	VIS PFH 8x1-1/2



K05 ÉTAGÈRE DE SERVICE - W4L19874
(x1) 5/8"x5 1/4"x37 1/2" (16x134x951)

ALIGNEZ LES TROUS PILOTES

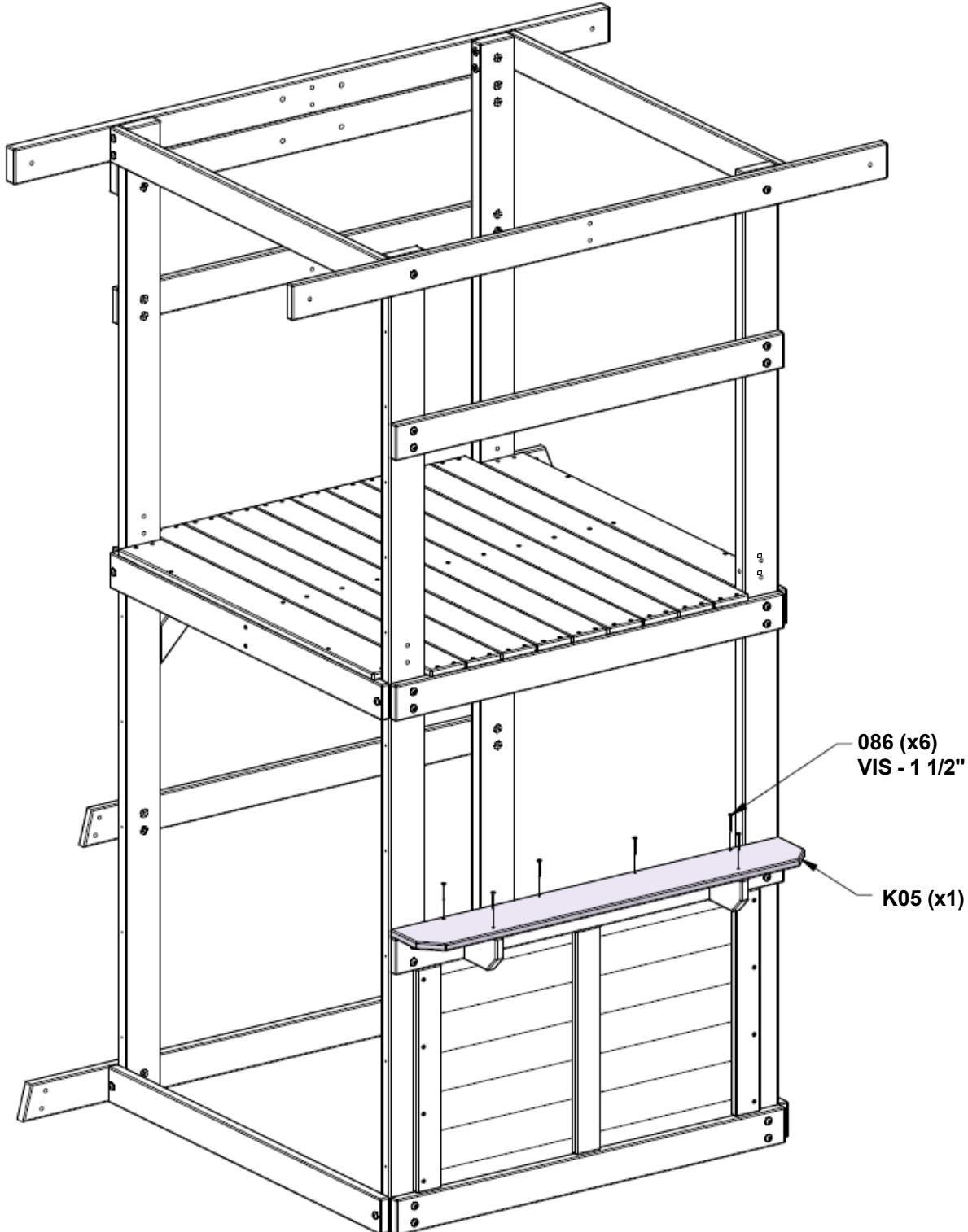

ÉTAPE 14 - FORT

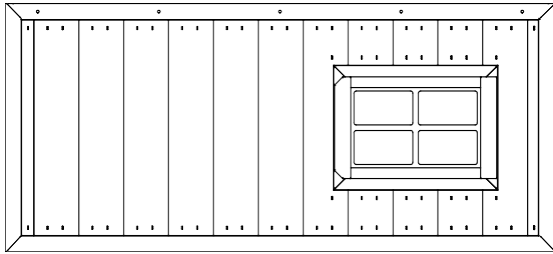

WP02 PANNEAU MURAL - W2A04228
(x1) 1 3/8"x18"x40" (36x460x1017)

QTÉ	N° DE PIÈCE	DESCRIPTION
8	H100087	VIS PFH 8x1-1/4
5	H100111	VIS PFH 8x2

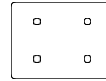

N01 TAQUET - W4L19902
(x2) 5/8"x2 3/8"x3 1/8" (16x60x80)

**ALIGNEZ LES
TROUS PILOTES**

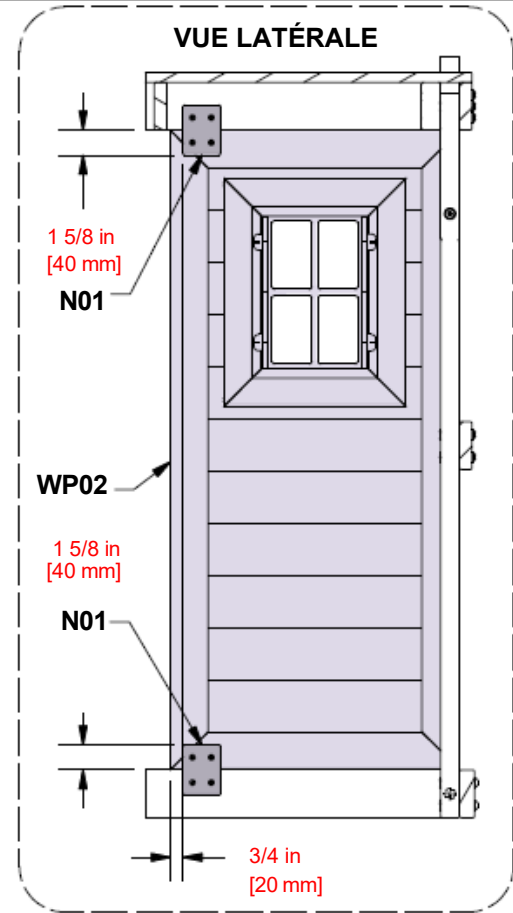
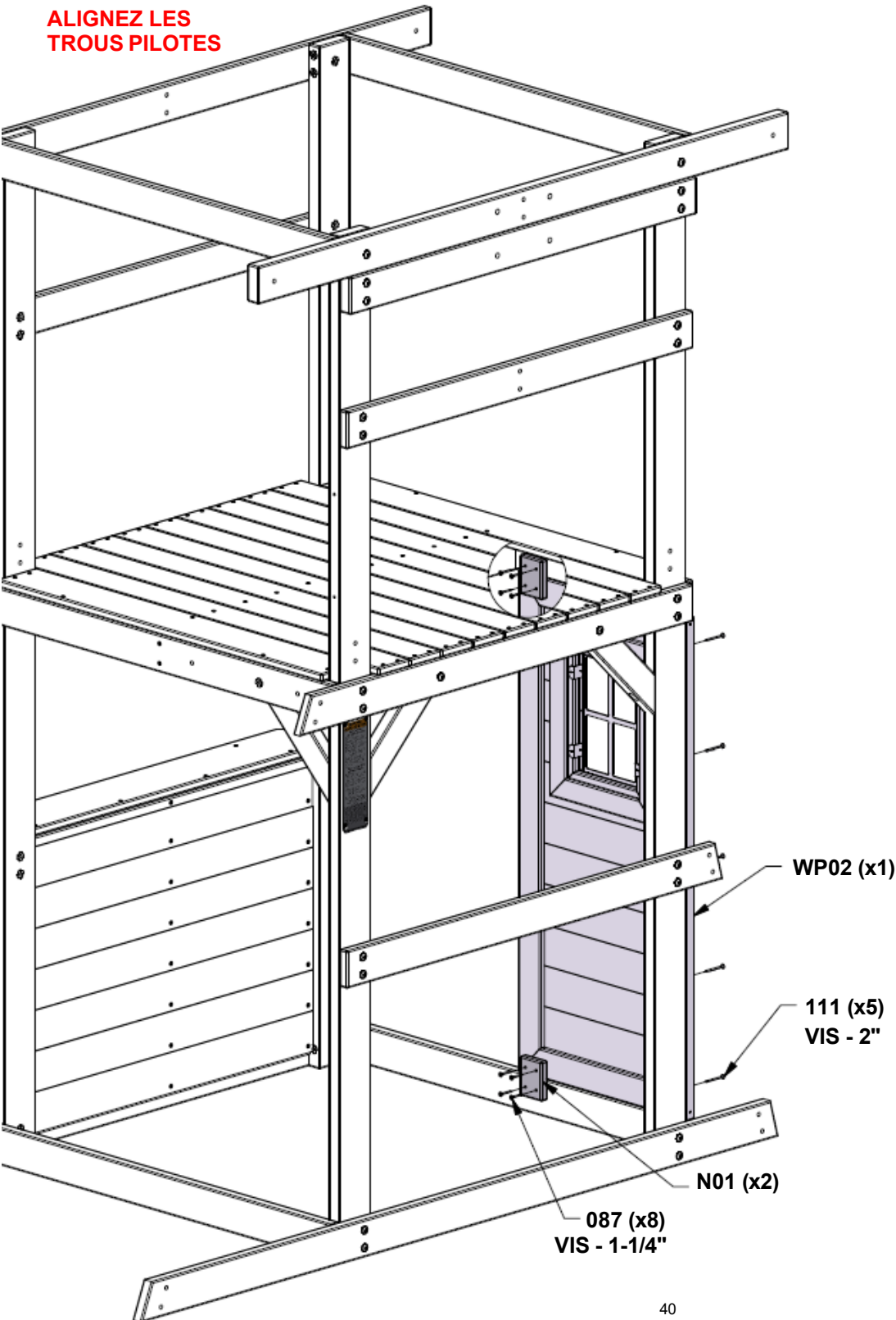

ÉTAPE 15 - FORT

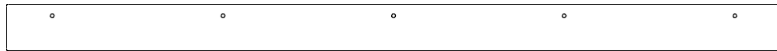

N04 PLANCHE MURALE - W4L19869
(x1) 5/8"x2 3/8"x40" (16x60x1017)

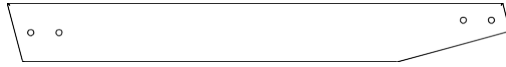

HS21 SUPPORT - W4L19887
(x1) 3/4"x3"x26 1/8" (20x76x662)

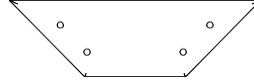

N02 CALE DE PORTE - W4L19896
(x1) 5/8"x2 3/8"x7 7/8" (16x60x200)

QTÉ	N° DE PIÈCE	DESCRIPTION
4	H100072	ÉCROU EN T 1/4"
5	H100086	VIS PFH 8x1-1/2"
4	H100088	VIS PFH 8x1-1/8"
4	H100138	RONDELLE D'ARRÊT EXT 6x15
2	H100143	BOULON WH 1/4x1-1/2"
2	H101027	BOULON WH 1/4x1-3/4"

INSTALLEZ LES ÉCROUS EN T DANS LE BOIS TOUT D'ABORD
ALIGNEZ LES TROUS PILOTES

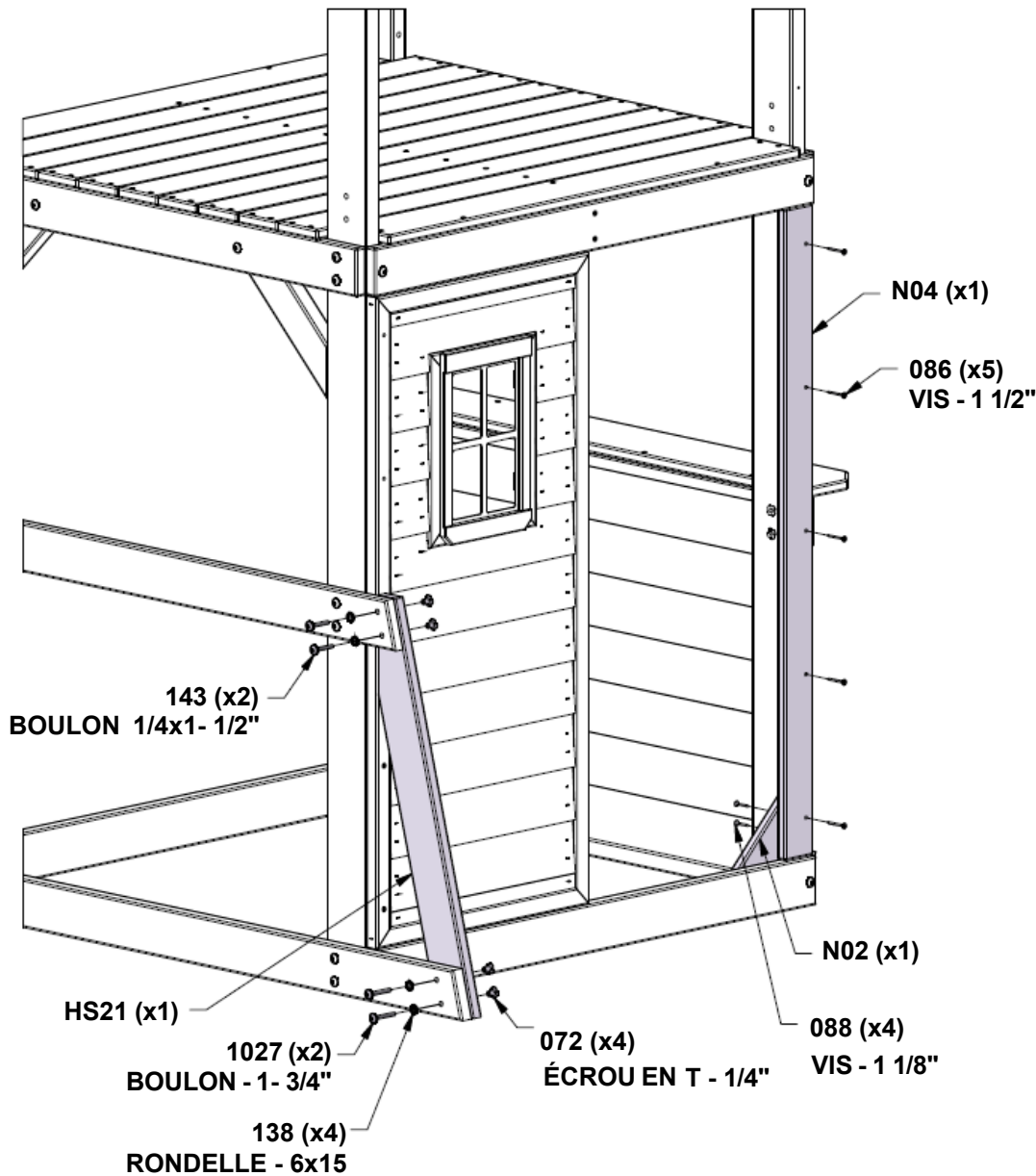

ÉTAPE 16 - FORT

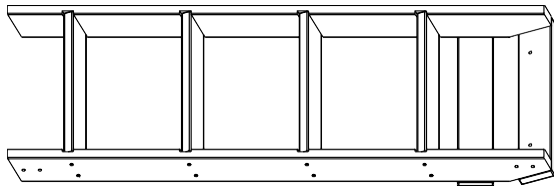

ASSEMBLAGE D'ÉCHELLE

QTÉ	N° DE PIÈCE	DESCRIPTION
6	H100072	ÉCROU EN T 1/4
6	H100138	RONDELLE D'ARRÊT EXT 6x15
4	H100160	BOULON WH 1/4x2
2	H101027	BOULON WH 1/4x1-3/4

INSTALLEZ LES ÉCROUS EN T DANS LE BOIS TOUT D'ABORD

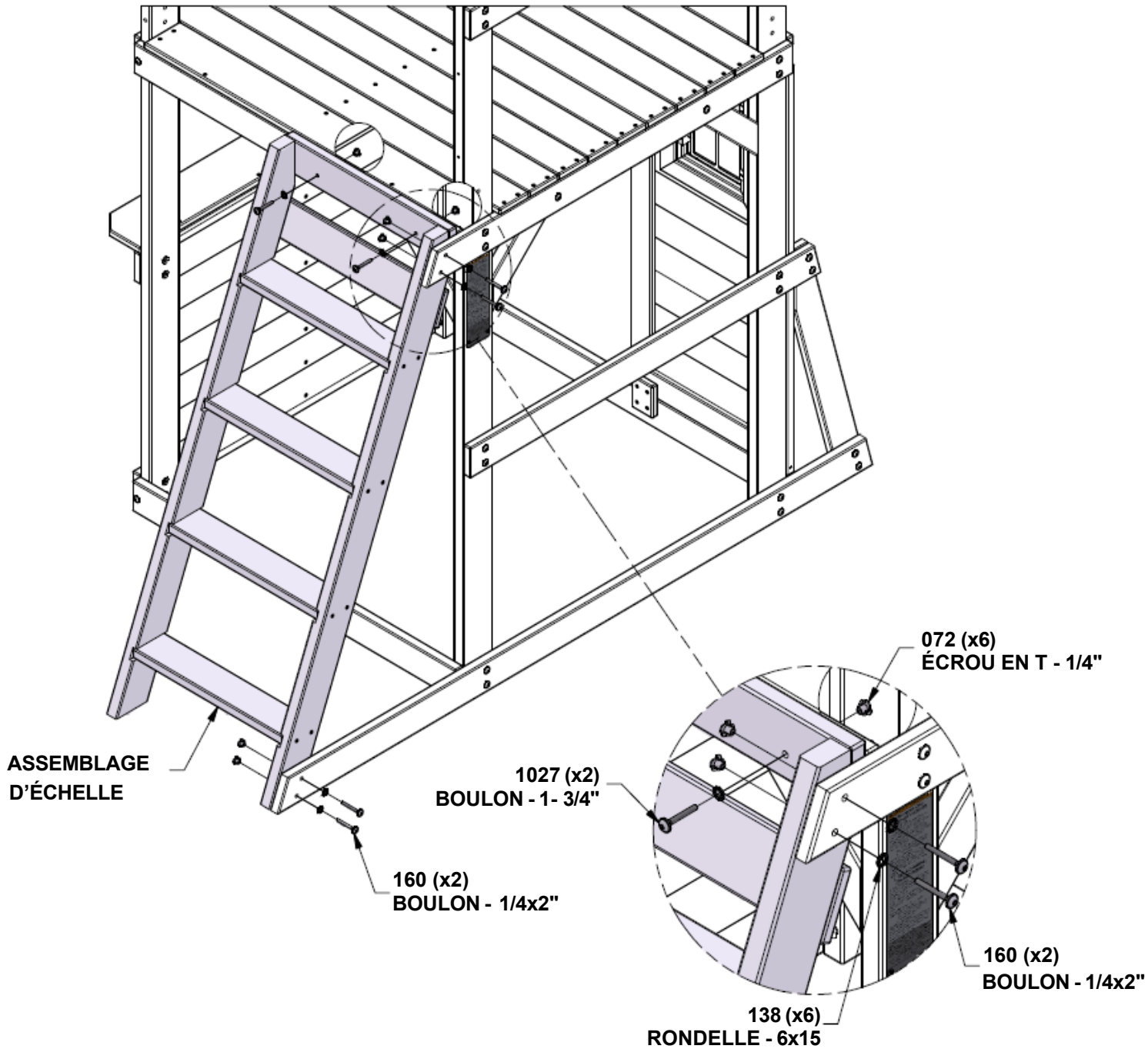

ÉTAPE 17 - FORT



HS15 PLANCHE MURALE - W4L19884
(x1) 3/4"x3"x37 1/2" (20x76x951)

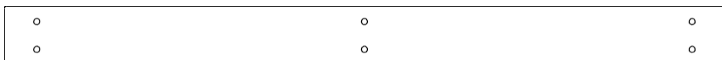

HS20 PLANCHE MURALE - W4L19898
(x1) 3/4"x3"x37 1/2" (20x76x951)

QTÉ	N° DE PIÈCE	DESCRIPTION
8	H100072	ÉCROU EN T 1/4"
8	H100138	RONDELLE D'ARRÊT EXT 6x15
8	H100160	BOULON WH 1/4x2

INSTALLEZ LES ÉCROUS EN T DANS LE BOIS TOUT D'ABORD

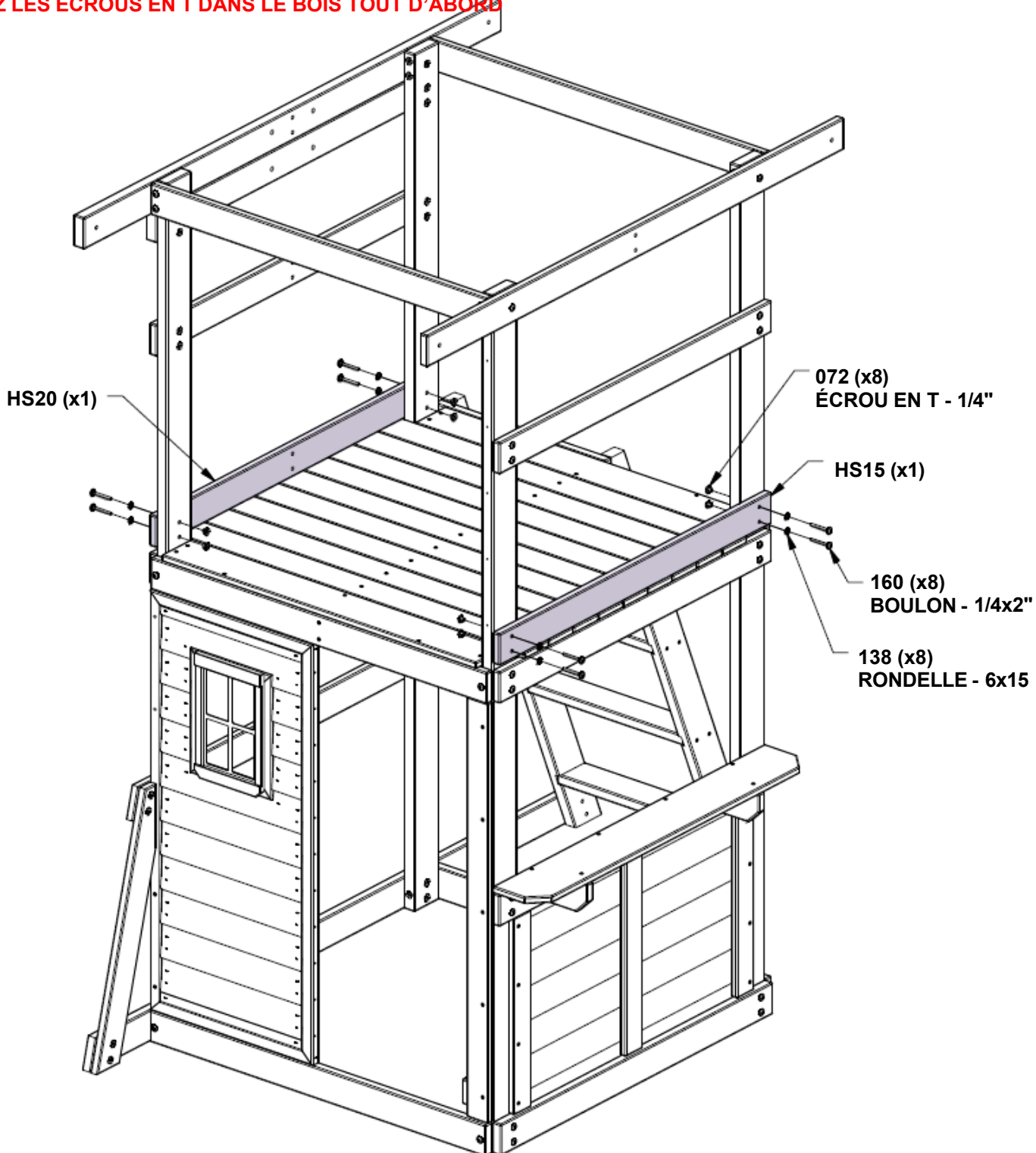

ÉTAPE 18 - FORT

QTÉ	N° DE PIÈCE	DESCRIPTION
1	H100072	ÉCROU EN T 1/4
1	H100138	RONDELLE D'ARRÊT EXT 6x15
1	H101175	BOULON WH 1/4x4 1/4

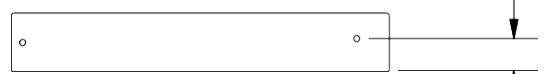

HS12 RAIL MURAL - W4L19894
(x1) 3/4"x3"x19 5/8" (20x76x499)

1 3/4 in
[43 mm]
VERS LE BAS LORS DE
L'INSTALLATION

INSTALLEZ LES ÉCROUS EN T DANS LE BOIS TOUT D'ABORD

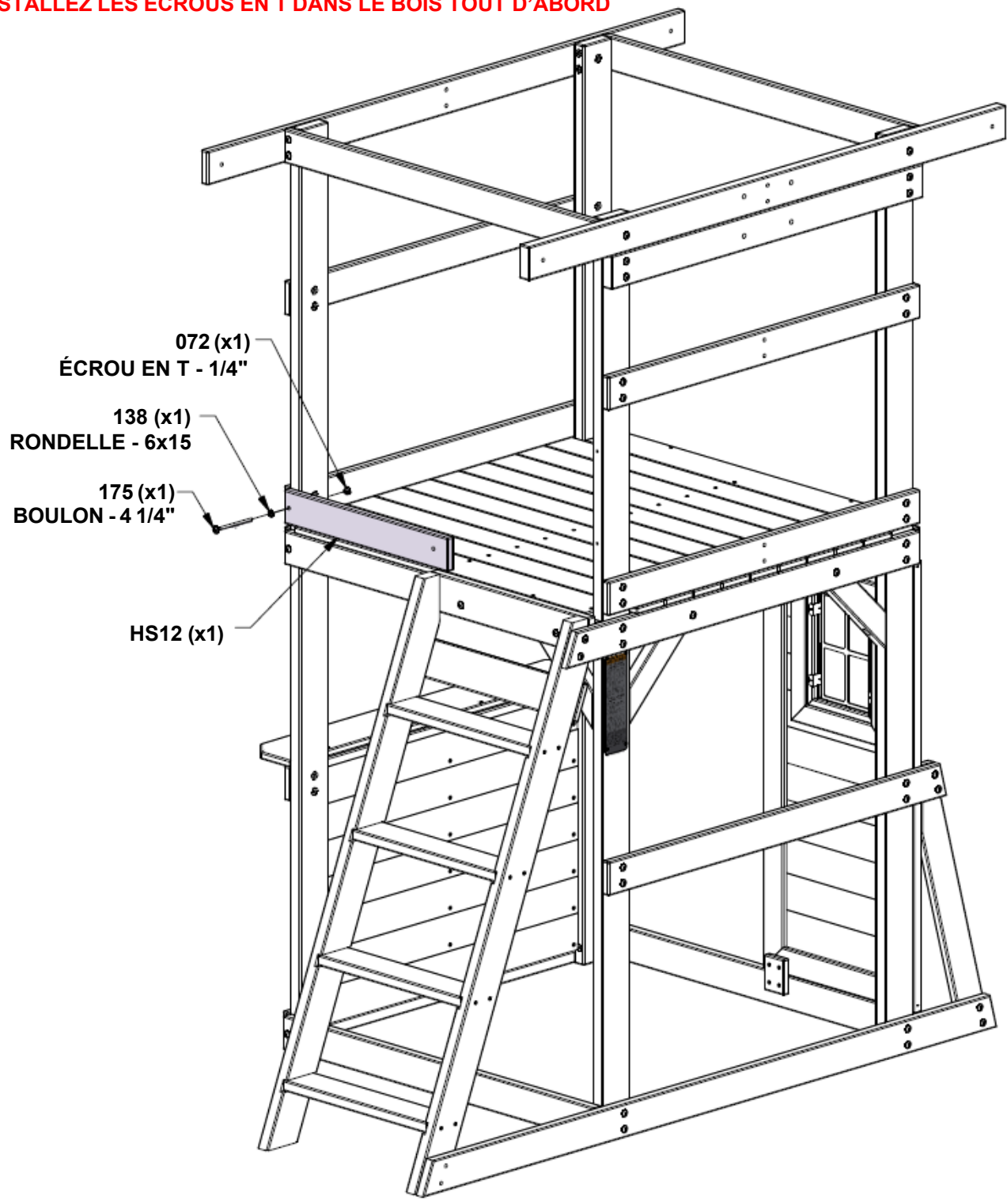

ÉTAPE 19 - FORT

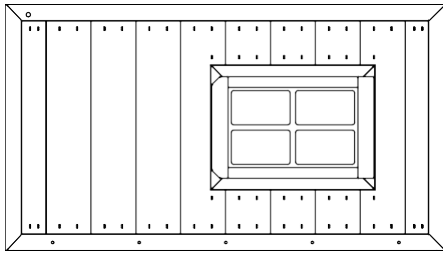

WP01 PANNEAU MURAL - W2A04225
(x1) 1 3/8"x18"x32" (36x455x813)

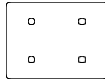

N01 TAQUET - W4L19902
(x1) 5/8"x2 3/8"x3 1/8" (16x60x80)

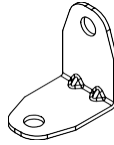

A4M01046 SUPPORT EN
(x1) 2.5x38x55x55

QTÉ	N° DE PIÈCE	DESCRIPTION
1	H100072	ÉCROU EN T 1/4"
4	H100087	VIS PFH 8x1-1/4"
5	H100111	VIS PFH 8x2"
1	H100136	ÉCROU EN BARILLET WH 1/4x5/8"
1	H100138	RONDELLE D'ARRÊT EXT 6x15"
2	H101110	BOULON WH 1/4x3/4"

ALIGNEZ LES TROUS PILOTES

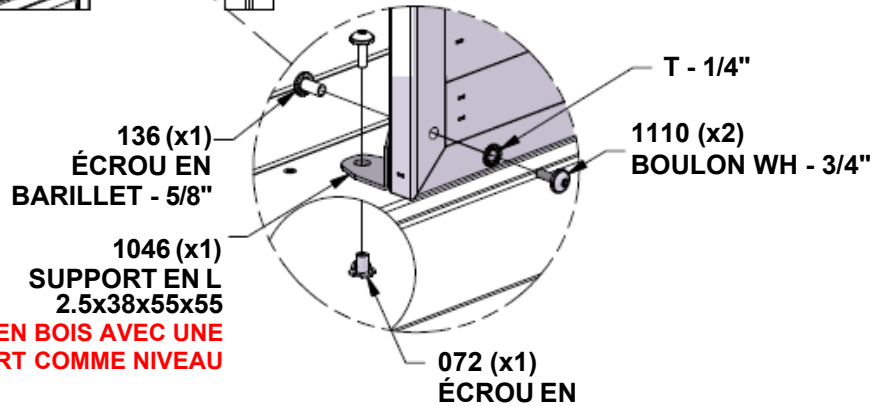
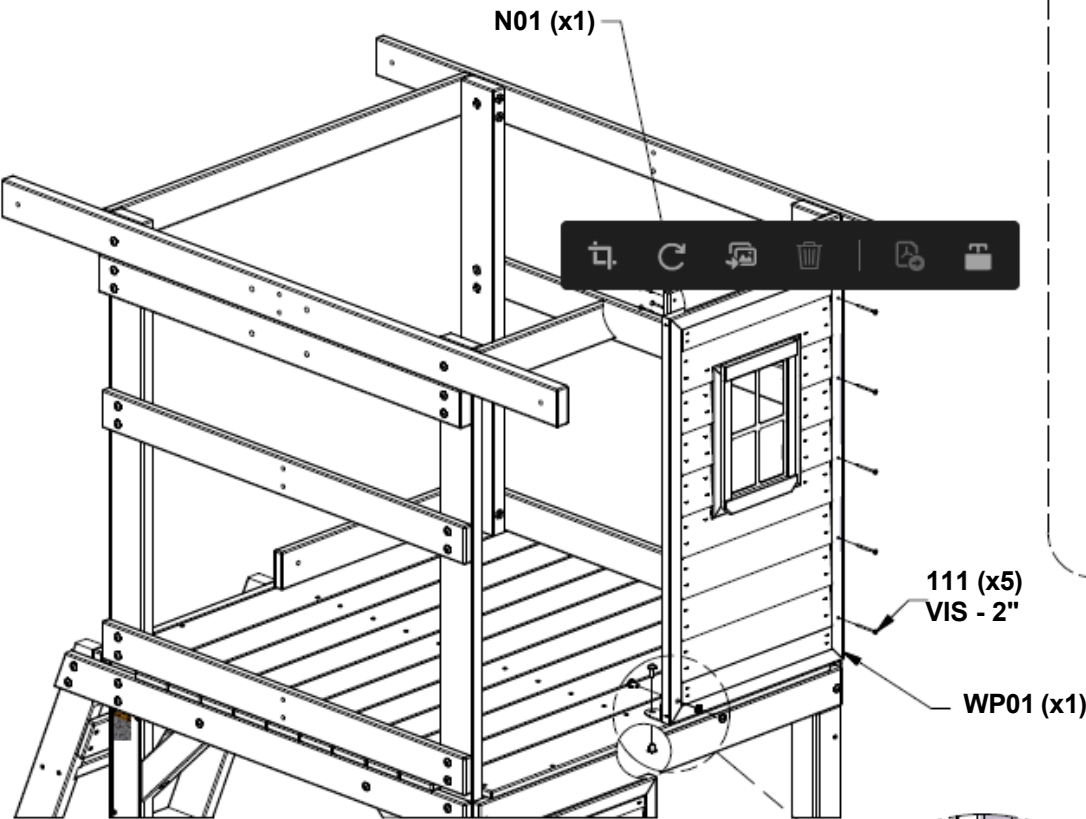
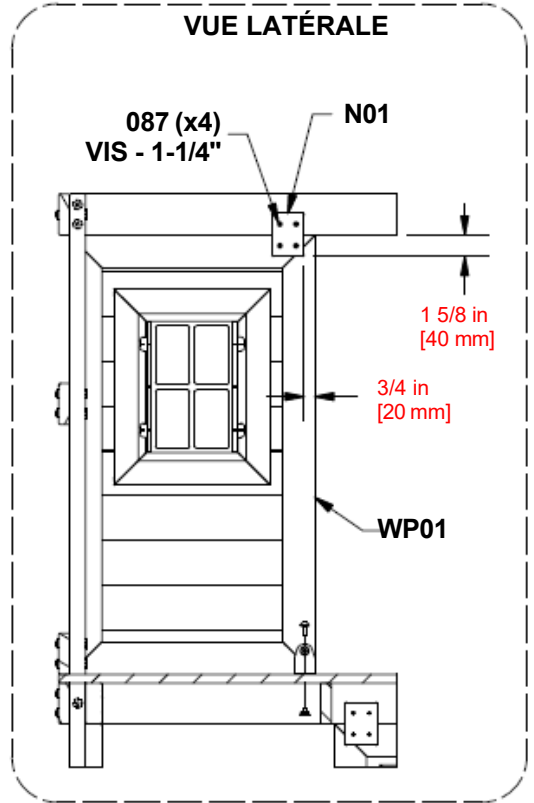

FOREZ DES TROUS À TRAVERS LE TERRASSE EN BOIS AVEC UNE MÈCHE À 5/16" (8MM) EN UTILISANT LE SUPPORT COMME NIVEAU

ÉTAPE 20 - FORT

QTÉ	N° DE PIÈCE	DESCRIPTION
36	H100088	VIS PFH 8x1-1/8



M14 PIQUET - W4L19893
(x9) 5/8"x3 3/8"x18 1/4" (16x86x463)

UTILISEZ L'AIDE-PIQUET A6P00410 POUR L'ESPACEMENT

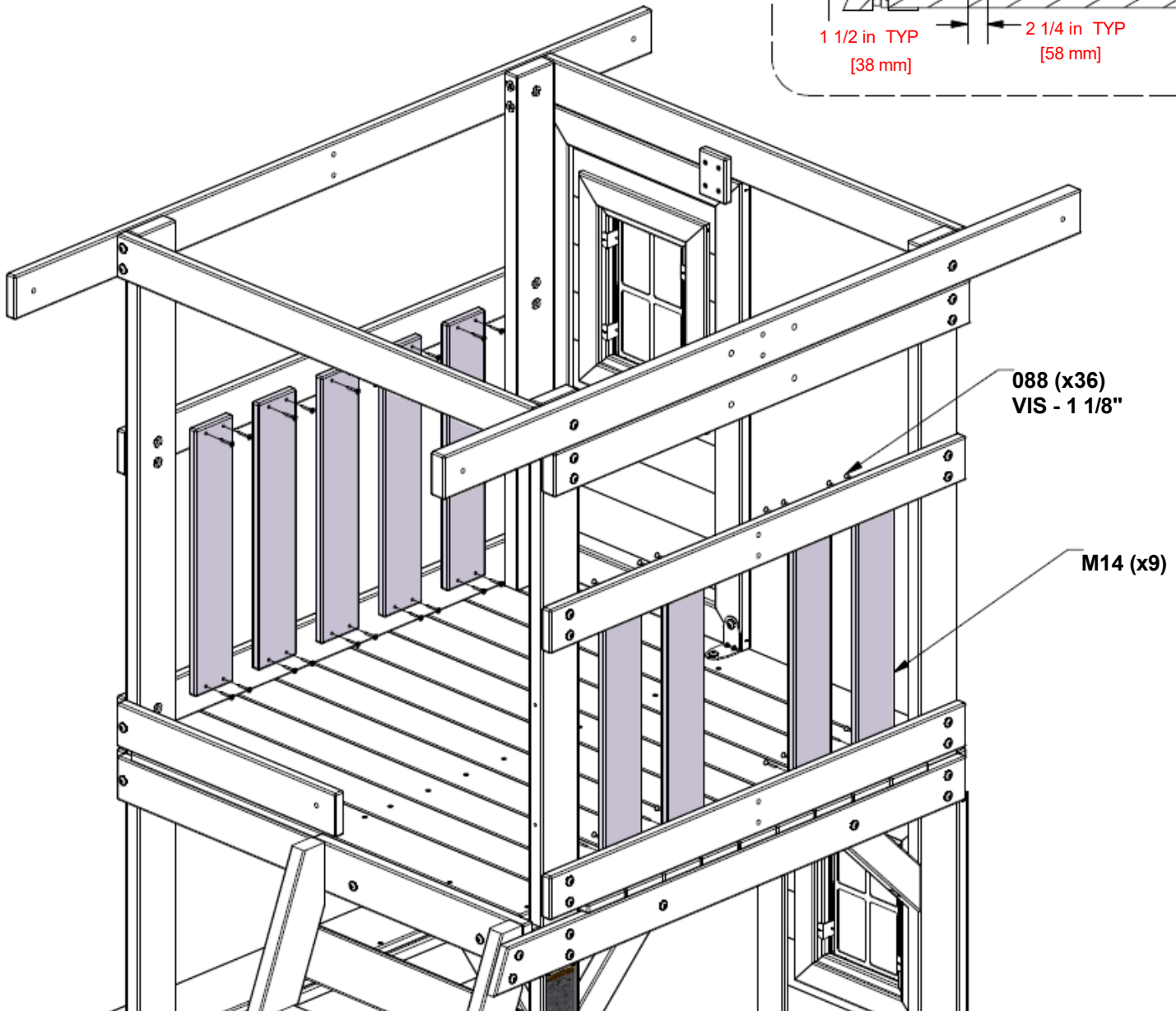
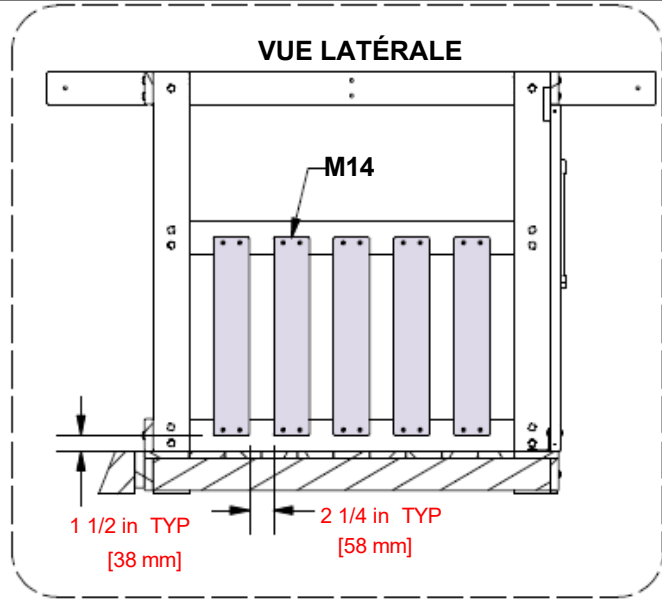

ÉTAPE 21 - FORT



M09 PLANCHE MURALE - W4L19888
(x1) 5/8"x3 3/8"x33 5/8" (16x86x854)



M10 PIQUET - W4L19889
(x2) 5/8"x3 3/8"x32 1/8" (16x86x816)

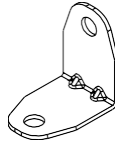

A4M01046 SUPPORT EN L
(x1) 2.5x38x55x55

QTÉ	N° DE PIÈCE	DESCRIPTION
1	H100072	ÉCROU EN T 1/4
10	H100088	VIS PFH 8x1-1/8
1	H100137	BOULON WH 1/4x1
1	H100138	RONDELLE D'ARRÊT EXT 6x15
1	H100140	ÉCROU EN BARILLET WH 1/4x7/8
1	H101110	BOULON WH 1/4x3/4

**UTILISEZ A6P00410
AIDE-PIQUET FOR
SPACING**

**NOTEZ L'EMPLACEMENT
DE TROUS**

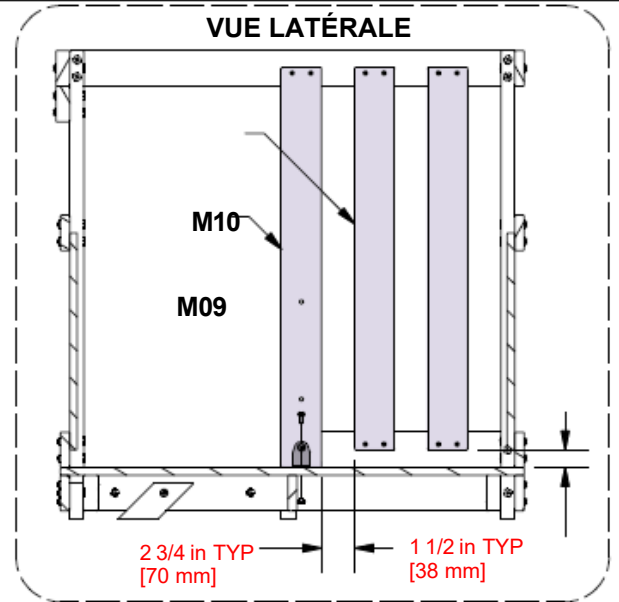
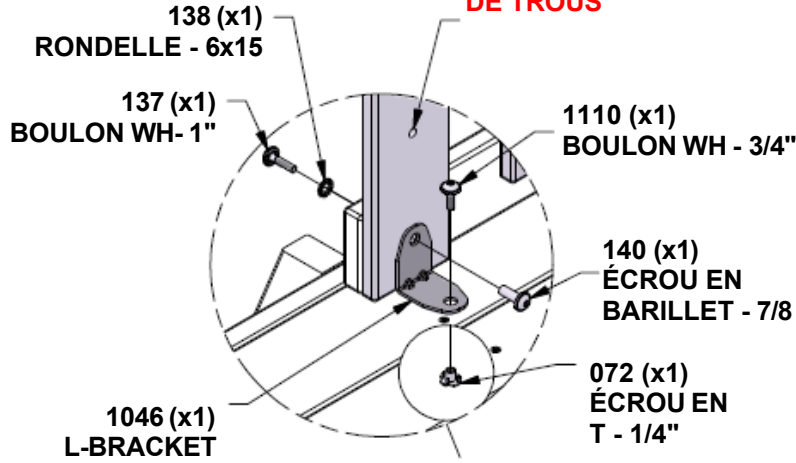

**FOREZ DES TROUS À TRAVERS
LE TERRASSE EN BOIS AVEC
UNE MÈCHE À 5/16" (8MM) EN
UTILISANT LE SUPPORT
COMME NIVEAU**

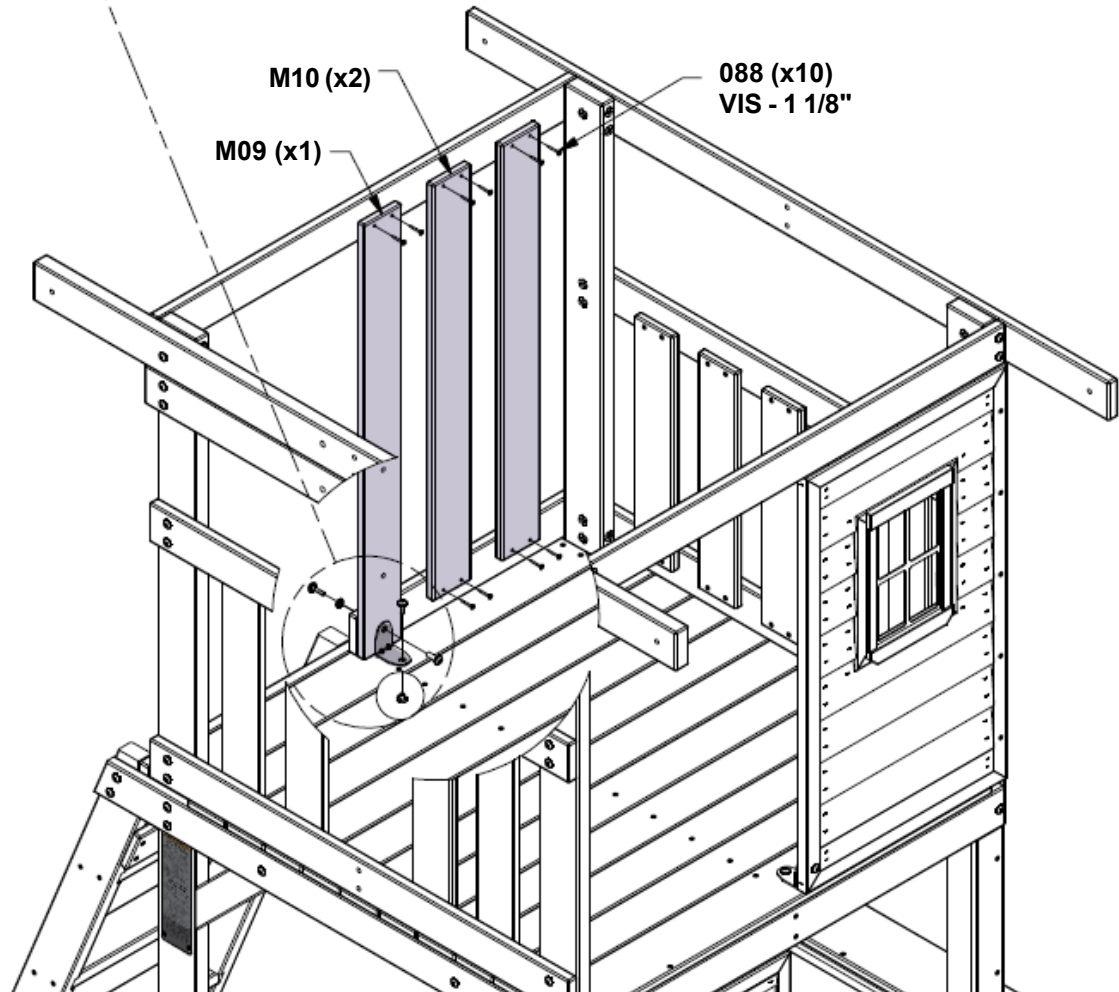

ÉTAPE 22 - FORT

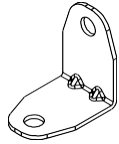

A4M01046 SUPPORT EN L
(x4) 2.5x38x55x55

QTÉ	N° DE PIÈCE	DESCRIPTION
6	H100072	ÉCROU EN T 1/4
2	H100136	ÉCROU EN BARILLET WH 1/4x5/8
2	H100137	BOULON WH 1/4x1
2	H100138	RONDELLE D'ARRÊT EXT 6x15
6	H101110	BOULON WH 1/4x3/4



INSTALLEZ LES ÉCROUS EN T TOUT D'ABORD

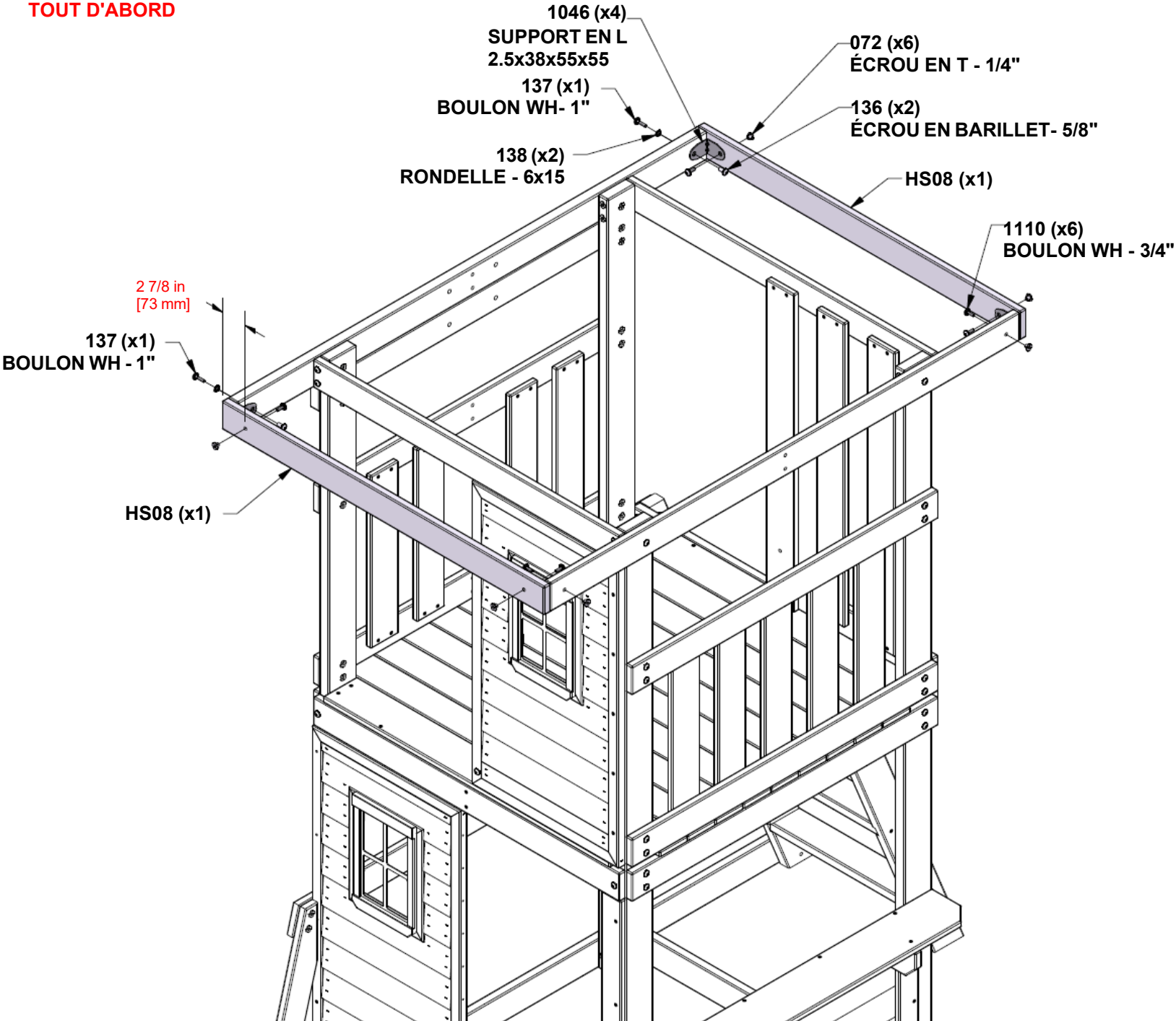

ÉTAPE 23 - FORT



HS11 MONTANT DE TOIT - W4L19868
(x1) 3/4"x3"x55 7/8" (20x76x1419)



M07 HAUT RAIL DE TOIT - W4L19886
(x1) 5/8"x3"x37 1/2" (16x76x951)



HS06 MONTANT DE TOIT - W4L19863
(x1) 3/4"x3"x23 7/8" (20x76x605)

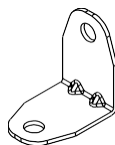

A4M01046 SUPPORT EN L
(x2) 2.5x38x55x55

QTÉ	N° DE PIÈCE	DESCRIPTION
12	H100072	ÉCROU EN T 1/4
8	H100138	RONDELLE D'ARRÊT EXT 6x15
6	H100143	BOULON WH 1/4x1-1/2
2	H100160	BOULON WH 1/4x2
4	H101110	BOULON WH 1/4x3/4

INSTALLEZ LES ÉCROUS EN T DANS LE BOIS TOUT D'ABORD

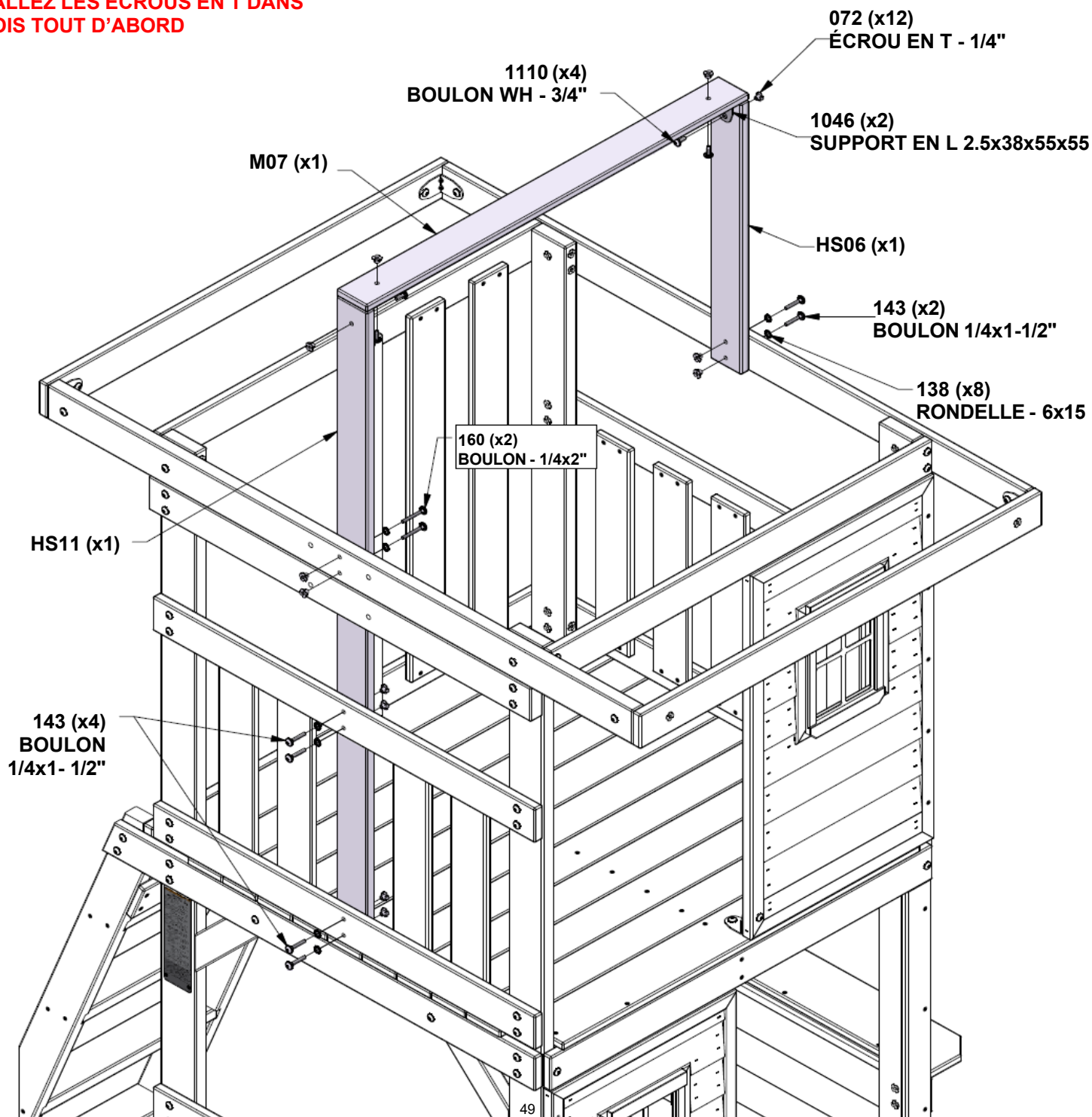

ÉTAPE 24 - FORT

QTÉ	N° DE PIÈCE	DESCRIPTION
4	H100074	ÉCROU EN T 5/16
42	H100128	VIS PWH 8x5/8

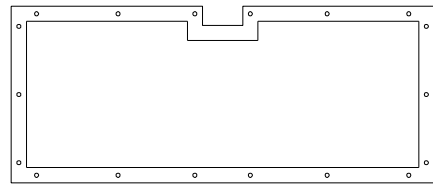

A6P01382 PANNEAU EN FILET (x1)

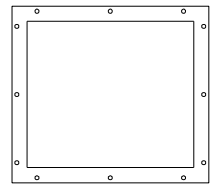

A6P01383 PANNEAU EN FILET (x2)

INSTALLEZ LES ÉCROUS EN T DANS LE BOIS TOUT D'ABORD

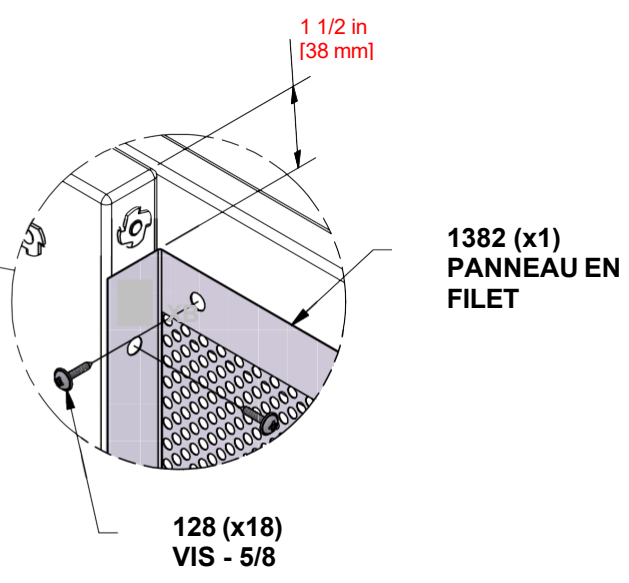
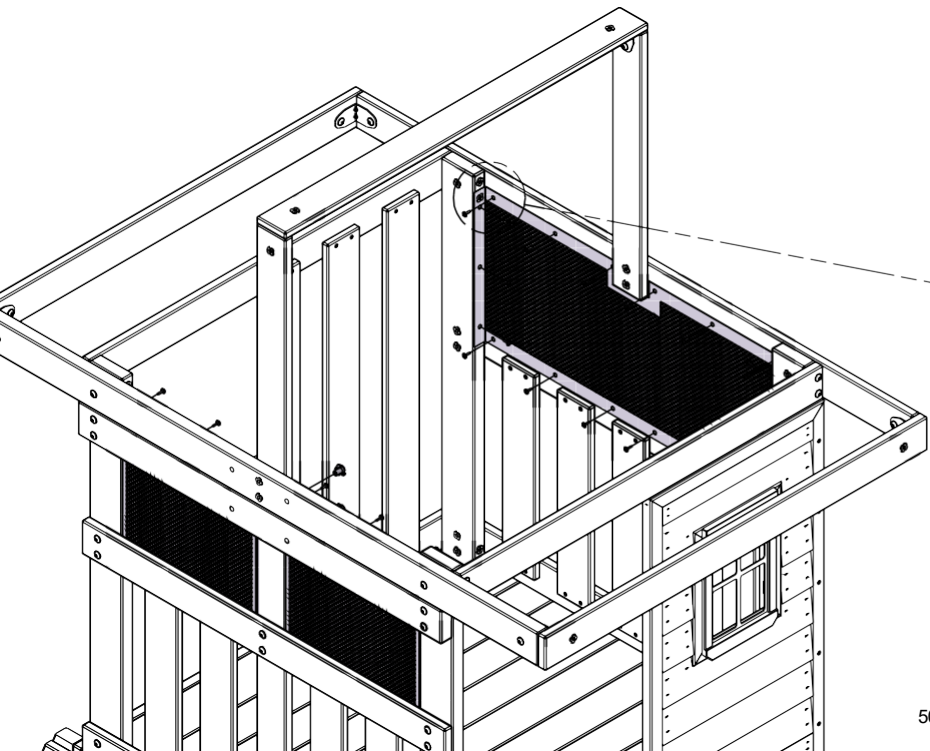
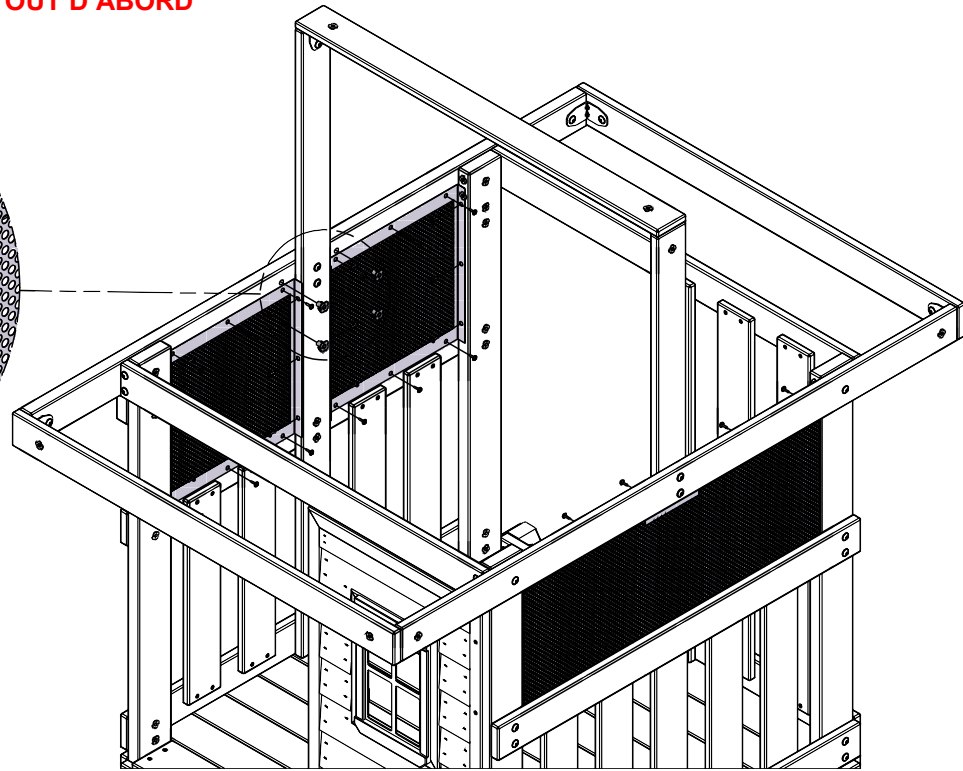
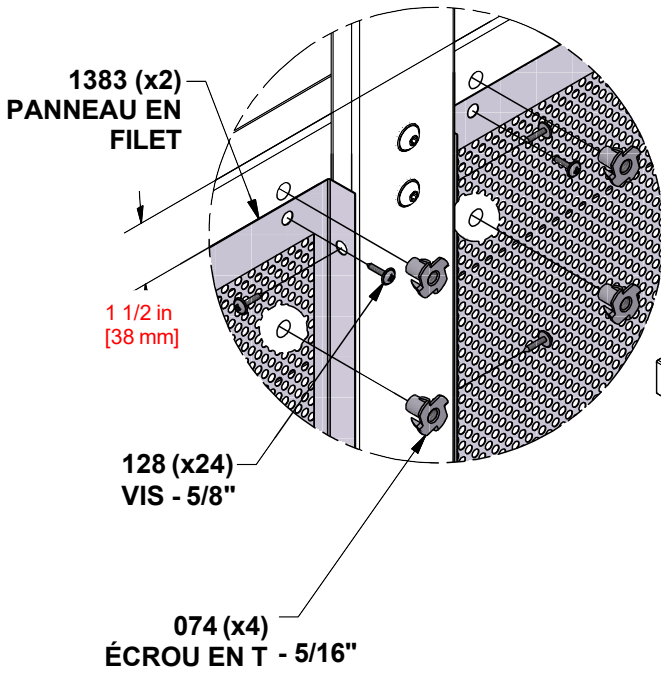

ÉTAPE 25 - FORT

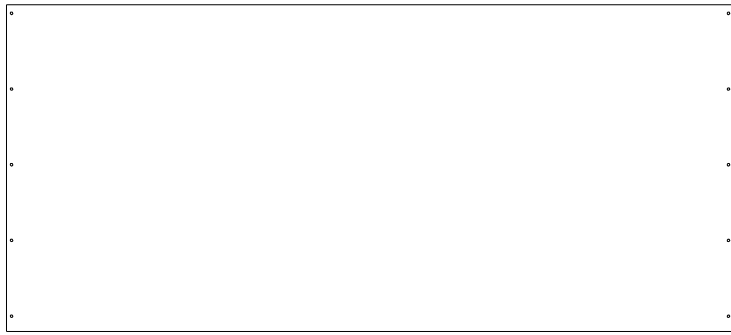

QTÉ	N° DE PIÈCE	DESCRIPTION
10	H100128	VIS PWH 8x5/8

A6P01172 BÂCHE À TOIT
(x1)

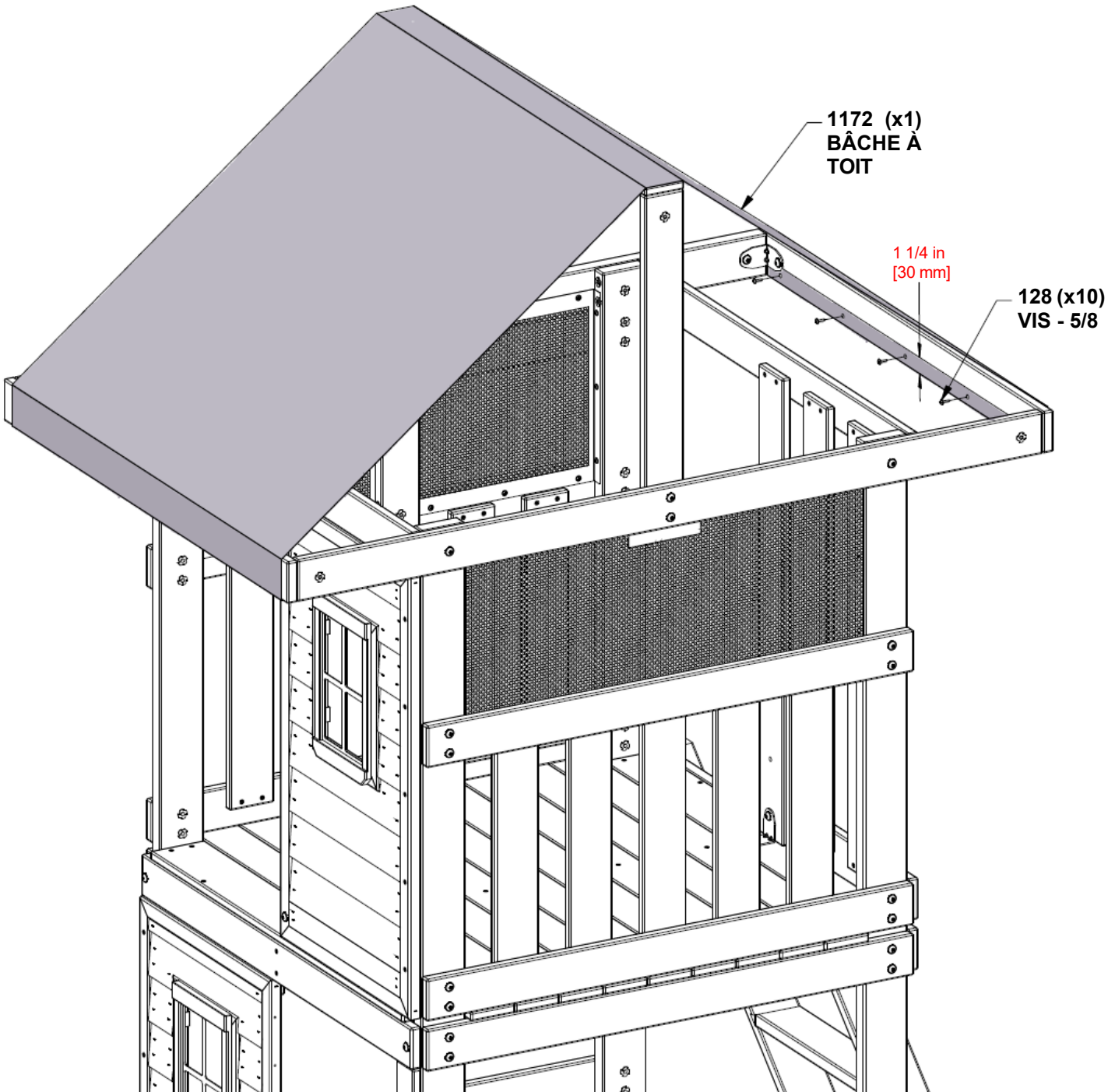

ÉTAPE 26 - FORT

QTÉ	N° DE PIÈCE	DESCRIPTION
2	H100072	ÉCROU EN T 1/4
2	H100137	BOULON WH 1/4x1
4	H100138	RONDELLE D'ARRÊT EXT 6x15
2	H100145	TIREFOND WH 1/4x1-1/2

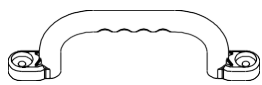

A100028 POIGNÉE VERTE
(x2)

**INSTALLEZ LES ÉCROUS EN T DANS LE BOIS TOUT D'ABORD
ALIGNÉZ LES TROUS PILOTES**

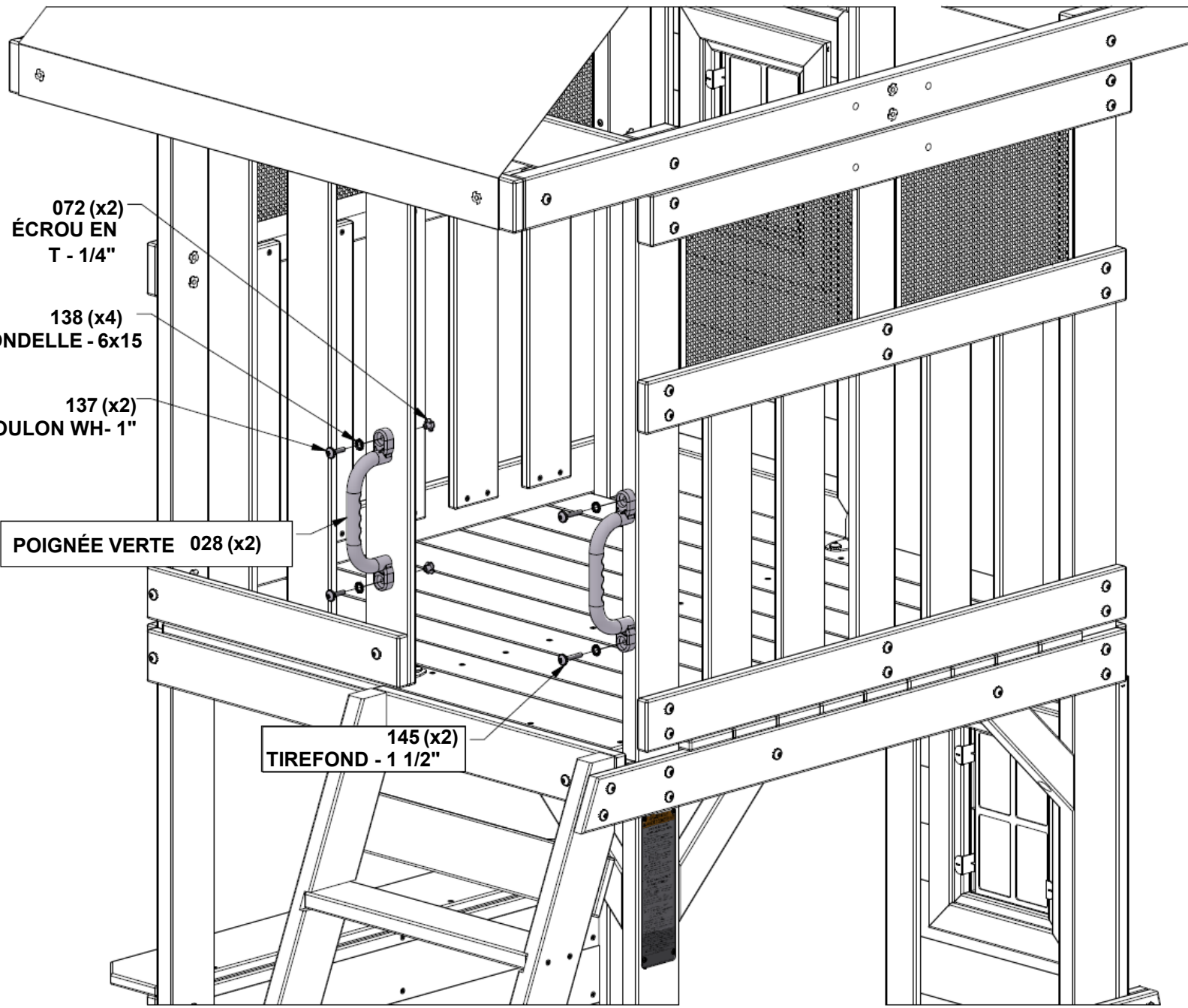

ÉTAPE 27 - FORT

QTÉ	N° DE PIÈCE	DESCRIPTION
11	H100086	VIS PFH 8x1-1/2

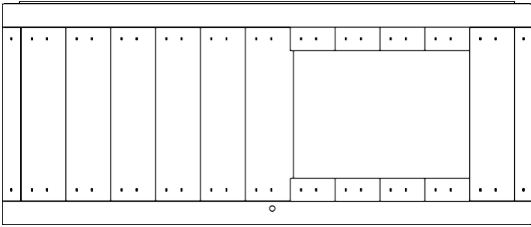

DP01 PANNEAU DE PORTE - W2A04226
(x1) 1"x16"x38 5/8" (24x407x980)

ALIGNER LES TROUS PIOTES

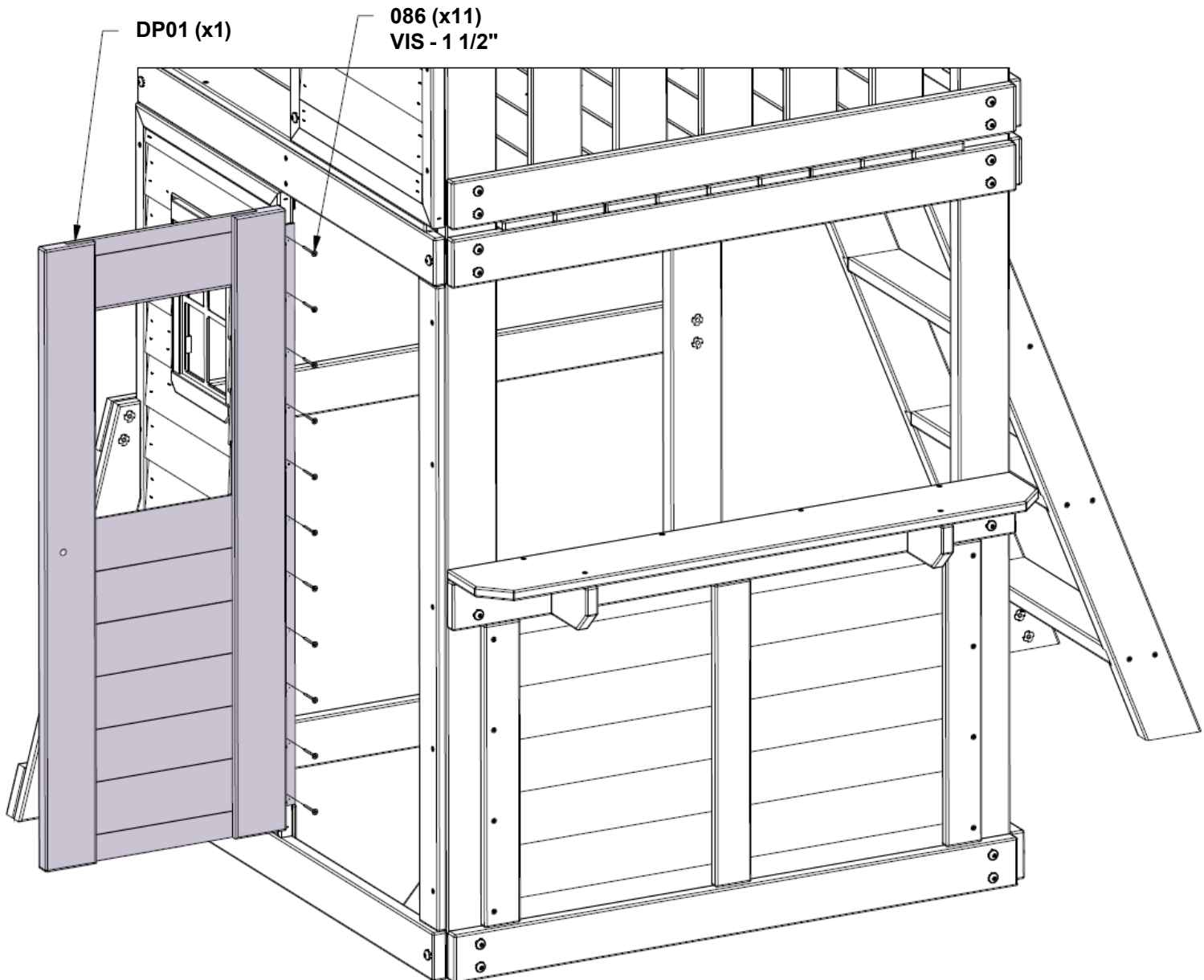

ÉTAPE 28 - FORT

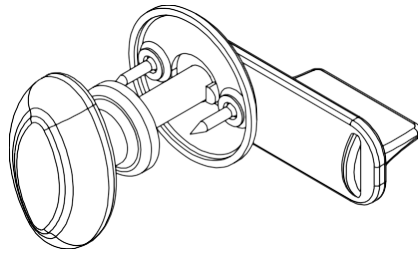

A6P01381 POIGNÉE D'ENCLIQUETAGE
(x1)

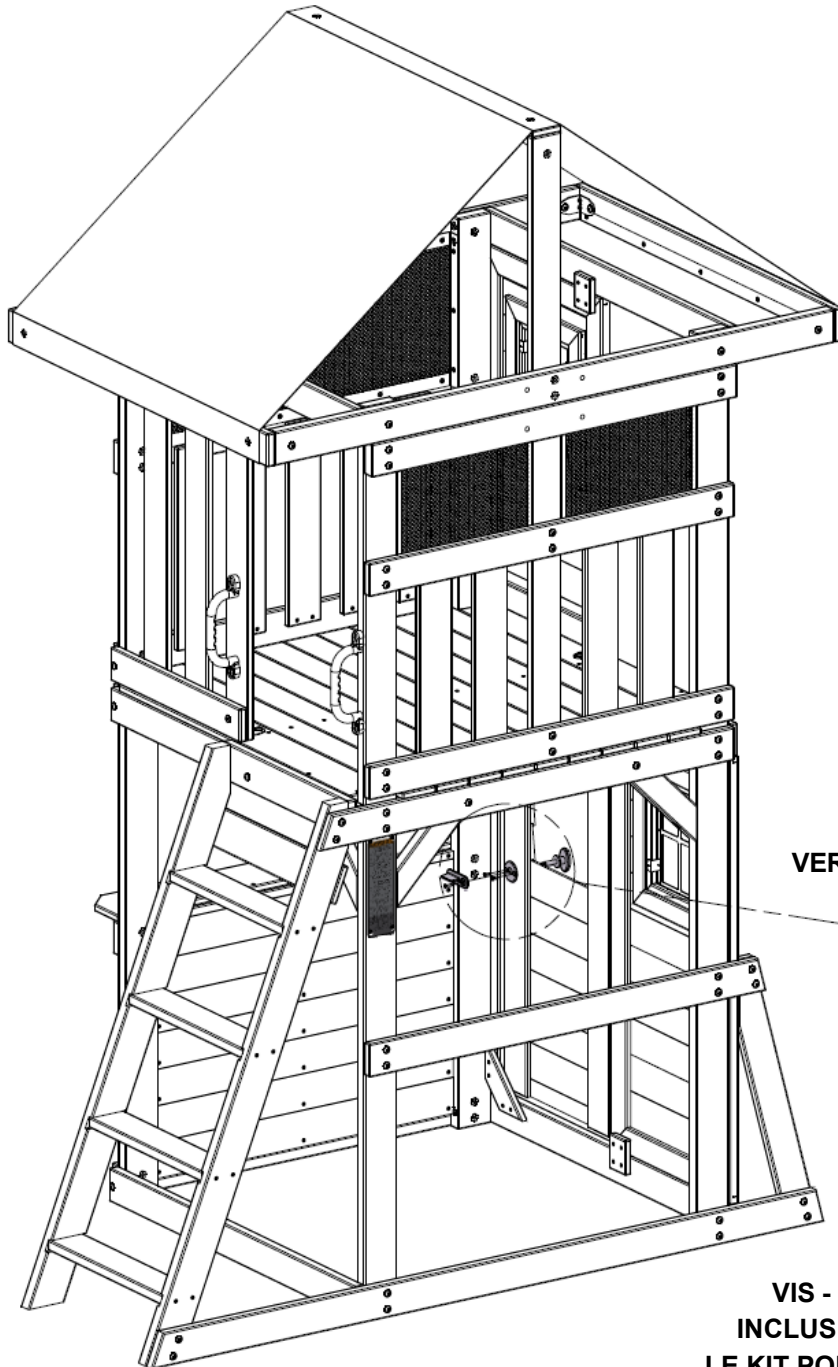

**ARCHEZ VERS LE HAUT
LORS DE L'INSTALLATION**

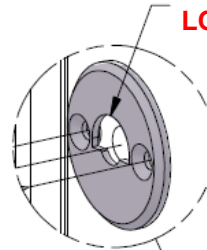

PLAQUE

POIGNÉE

VERROU

VIS - 1" (x1)
INCLUS AVEC
LE KIT POIGNÉE

VIS - 3/4" (x2) INCLUS
AVEC LE KIT POIGNÉE

ÉTAPE 29 - FORT

QTÉ	N° DE PIÈCE	DESCRIPTION
4	H100042	BOULON HEX 5/16x1 1/4
4	H100095	RONDELLE FENDUE 5/16
4	H100105	RONDELLE PLATE 8x27

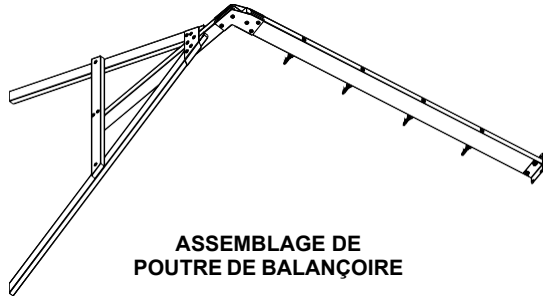

INSTALLEZ LES ÉCROUS EN T DANS LE BOIS TOUT D'ABORD

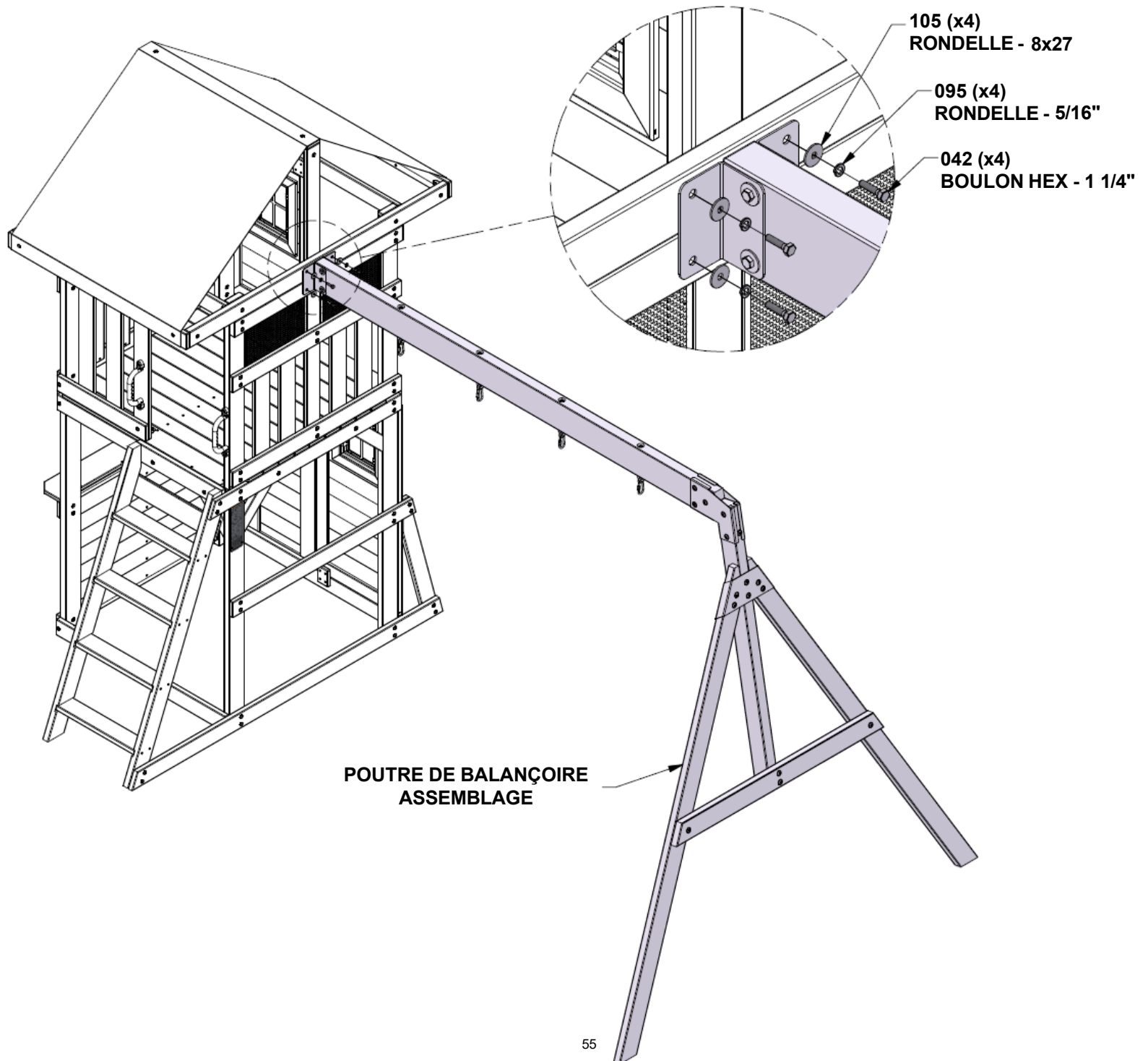

ÉTAPE 30 - FORT

QTÉ	N° DE PIÈCE	DESCRIPTION
4	H100124	VIS PFH 8x1/2



A100164 ÉTIQUETTE
(x1) LOGO BYD
(LARGE)

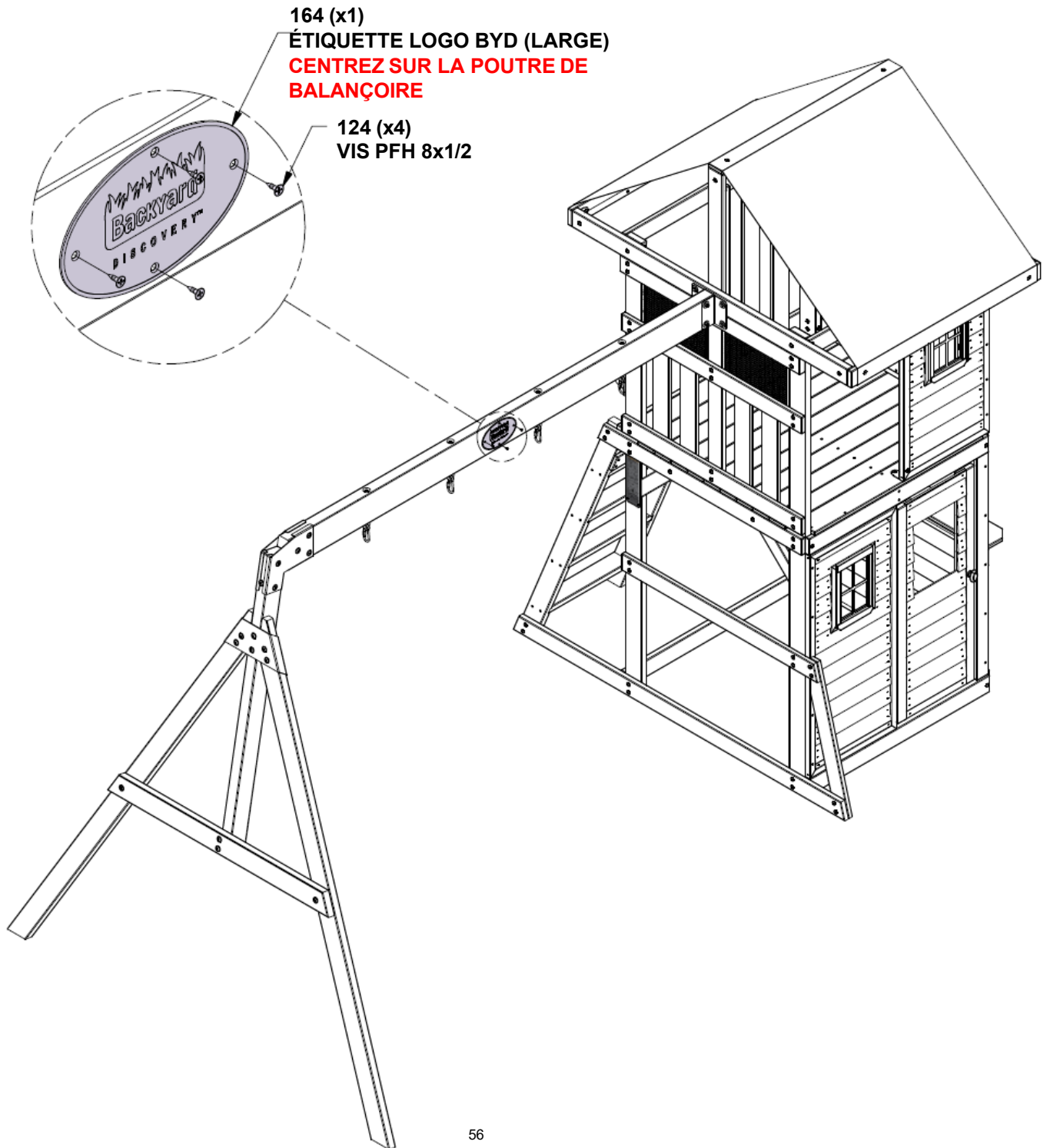

ÉTAPE 31 - FORT



A100087 CHAÎNE À
(x4) CORDE VERT
51.25"

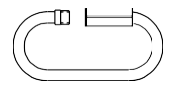

A100069 QUICK LINK
(x4)



A6P00054 SIÈGE À
(x2) BALANÇOIRE 22"

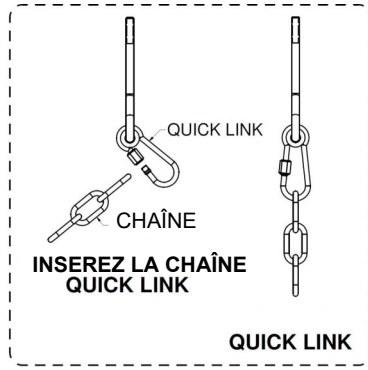

LORS DE L'INSTALLATION DES BALANÇOIRES, IL EST EXIGÉ DE COUPER AUTOUR DE LA BOUCLE DE CHAÎNE QUI PERMETTENT L'INFÉRIEUR DU SIÈGE DE BALANÇOIRE (LORS D'UNE PERSONNE SOIT ASSIS) D'ÊTRE NE PLUS QU'À 35CM DU SOL.

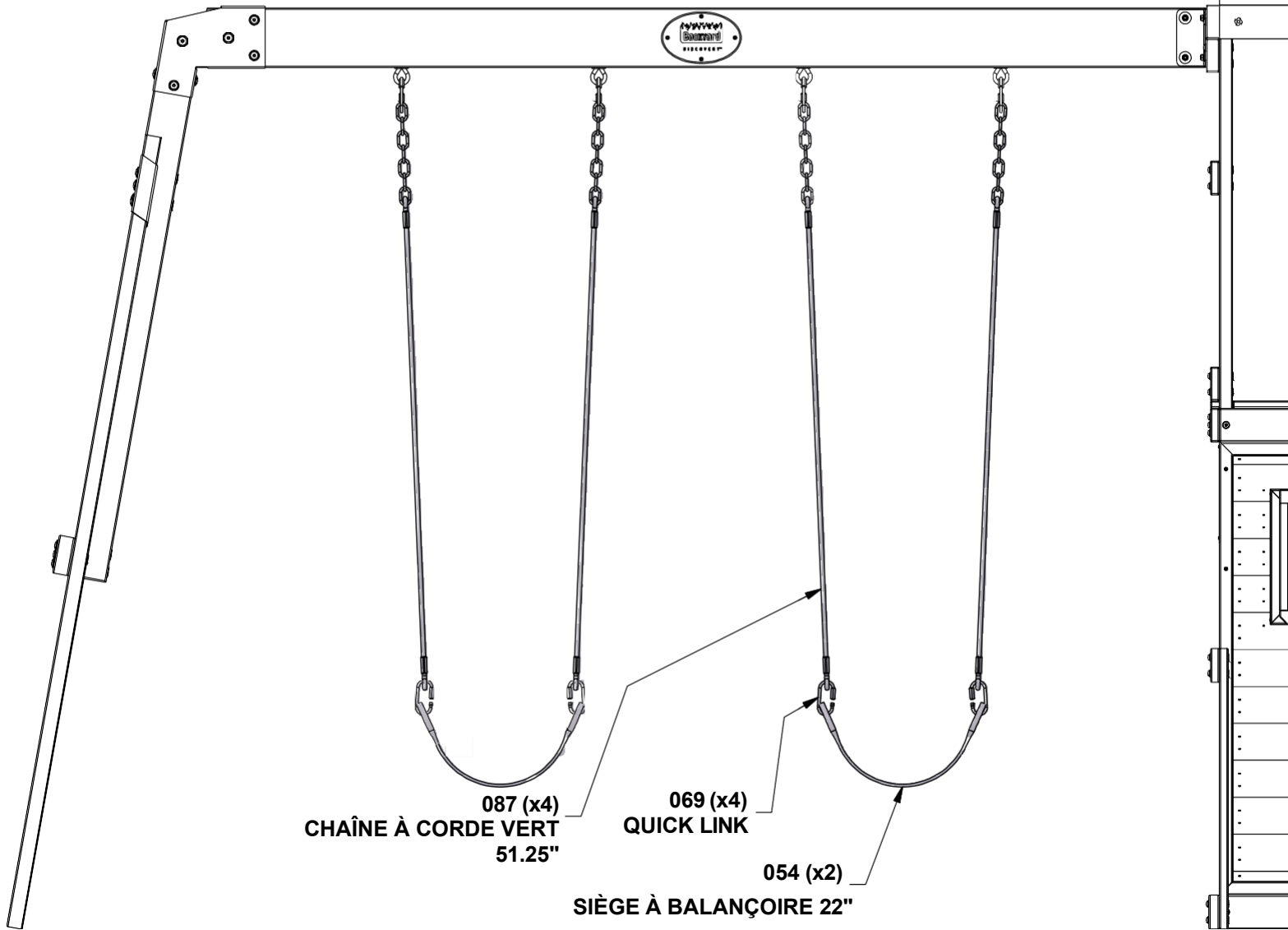

ÉTAPE 32 - FORT

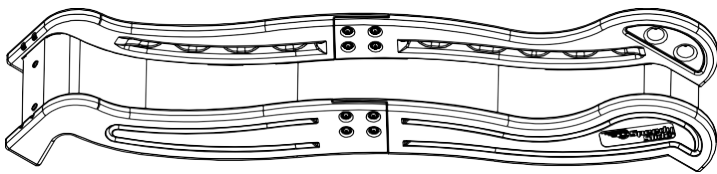

ASSEMBLAGE DE TOBOGGAN

QTÉ	N° DE PIÈCE	DESCRIPTION
2	H100074	ÉCROU EN T 5/16
2	H100115	BOULON WH 5/16x1/2

CENTREZ LE TOBOGGAN AU CENTRE DE L'OUVERTURE EN UTILISANT LES MESURES INDICUÉES AU-DESSOUS. FOREZ DES TROUS À TRAVERS LE SIÈGE DU TOBOGGAN ET LE TERRASSE EN BOIS POUR LA QUINCAILLERIE

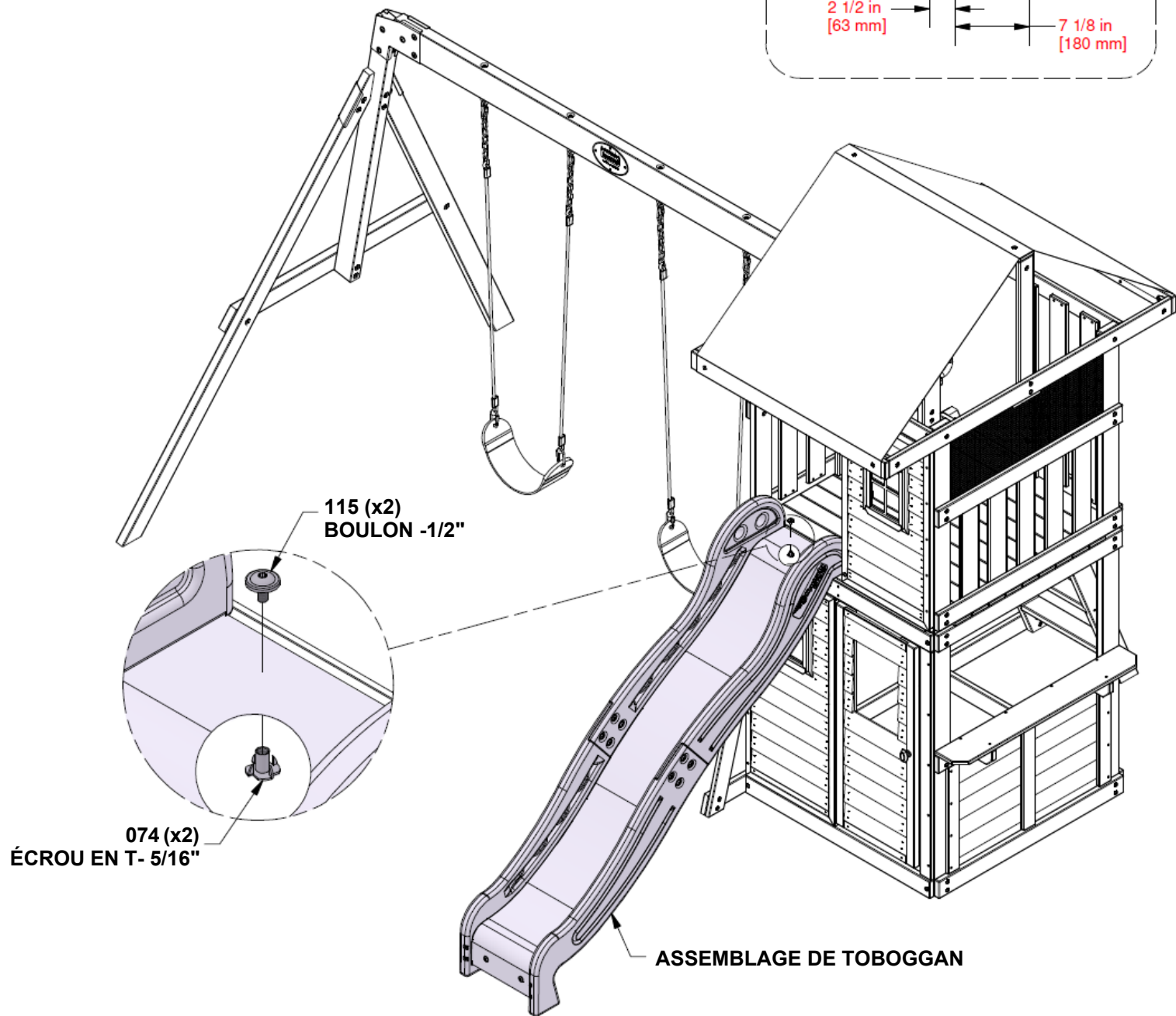
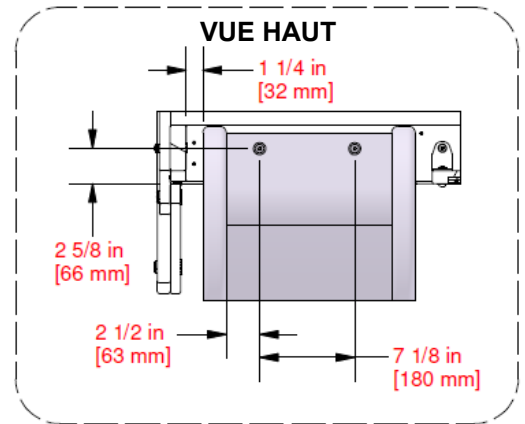

ÉTAPE 33 - FORT



A100178 PIQUET
(x6) FOREUSE

QTÉ	N° DE PIÈCE	DESCRIPTION
4	H100009	BOULON WH 5/16x1 1/4
2	H100011	BOULON WH 5/16x1 3/4
6	H100074	ÉCROU EN T 5/16

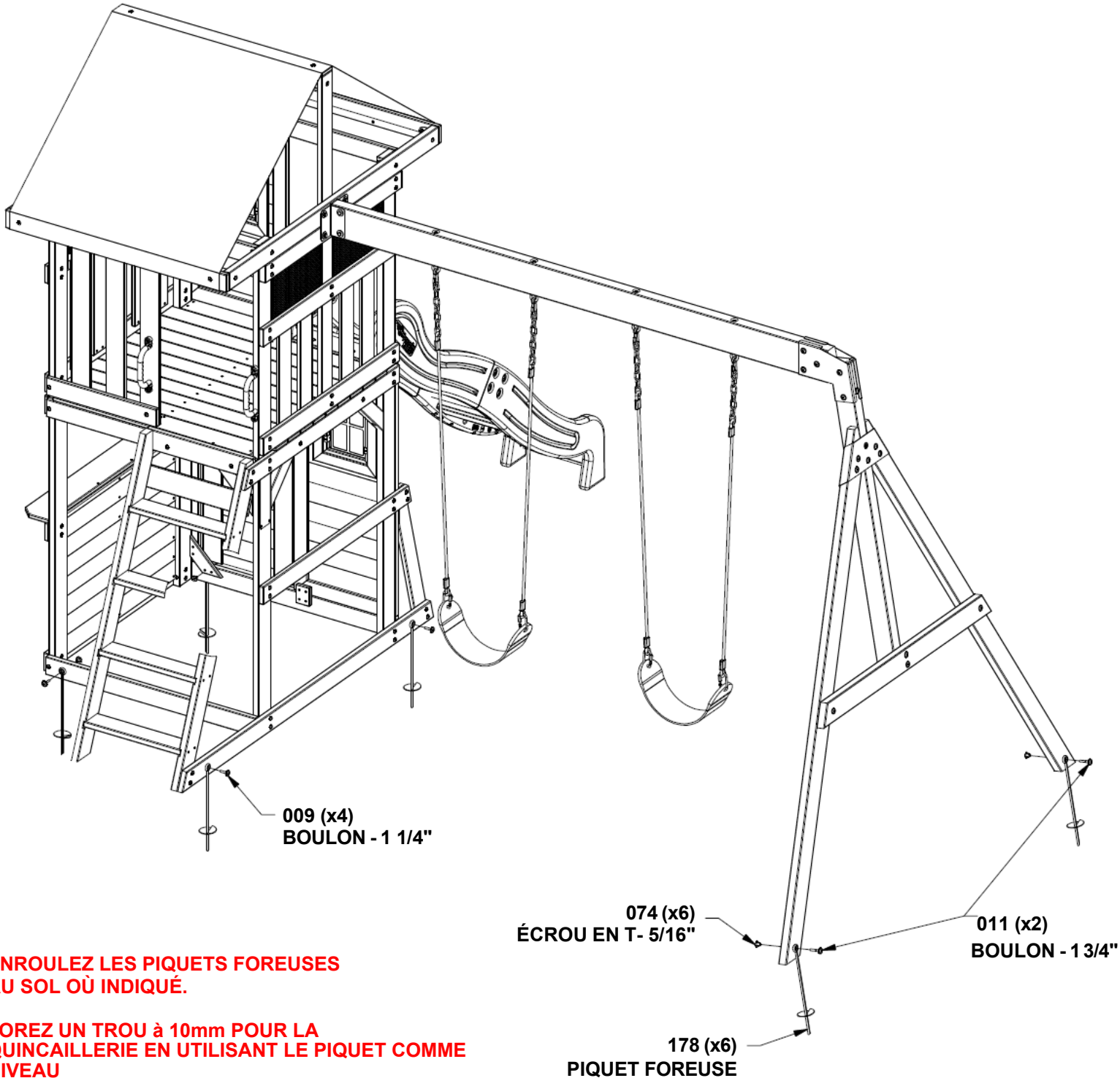

**ENROULEZ LES PIQUETS FOREUSES
AU SOL OÙ INDIQUÉ.**

**FOREZ UN TROU à 10mm POUR LA
QUINCAILLERIE EN UTILISANT LE PIQUET COMME
NIVEAU**

074 (x6)
ÉCROU EN T - 5/16"

011 (x2)
BOULON - 1 3/4"

178 (x6)
PIQUET FOREUSE