

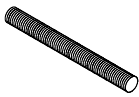







HEKMAN®

A HOWARD MILLER COMPANY

23340 WELLINGTON HALL CAPTAIN DESK

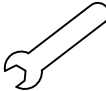
HARDWARE LIST							
A	B	C	D	E	F	G	H
BOLT M8 x 100 2 PCS.	HALFMOON WASHER M8 2 PCS.	HEXAGON NUTS M8 (2 PCS.)	ALLEN BOLT M8 X 40 (12 PCS)	FLAT W. M8 12 PCS.	SPRING W. M8 12 PCS.	ALLEN KEY L5 (FOR ALLEN BOLT) 1 PC.	WRENCH (FOR HEXA BOLT) 1 PC.
							

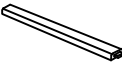

PART INSIDE		
1	2	3
TOP ASSEMBLY (1 Pc)	PEDESTAL (2 Pcs)	STRETCHER (1 Pc)
		

Assembly Instruction

STEP 1:

INSERT CONNECTING BOLT (A) INTO INSERT IN LEG ASSEMBLIES. PLACE STRETCHER IN POSITION AND LOCK WITH HALFMOON WASHER (B), HEXAGON NUTS (C) USING WRENCH (H) PROVIDED.

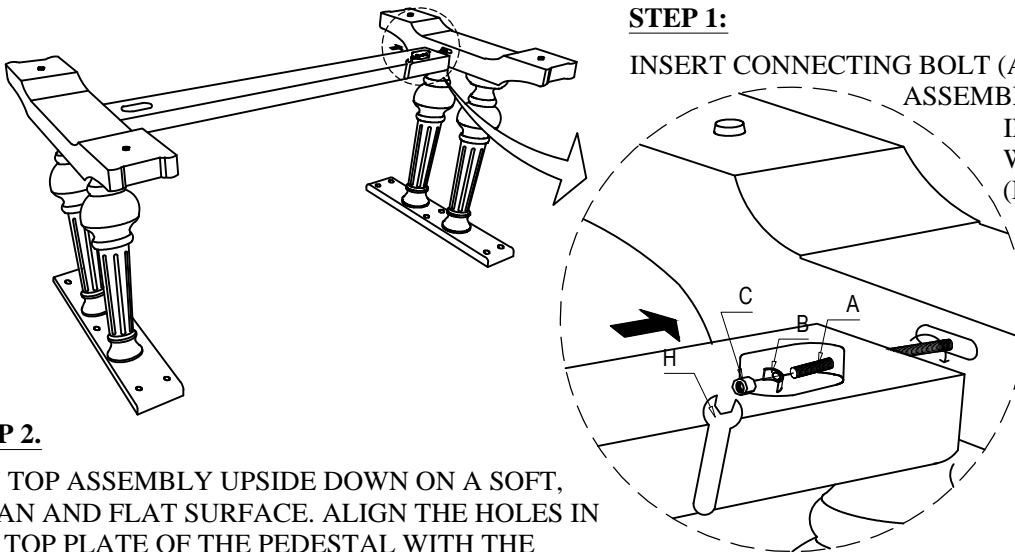

STEP 2.

LAY TOP ASSEMBLY UPSIDE DOWN ON A SOFT, CLEAN AND FLAT SURFACE. ALIGN THE HOLES IN THE TOP PLATE OF THE PEDESTAL WITH THE INSERTS IN THE BOTTOM PANEL OF THE TOP ASSEMBLY. CONNECT USING FLAT WASHER (E), SPRING WASHER (F), ALLEN BOLT (D) AND ALLEN KEY (G) PROVIDED.

