

Sereno Trim Series

Sereno Trim Series with TA-10 Flow Control Spindle & T-12A Cap Assembly
Installation & Operation Instructions

Model Numbers

TRIM ONLY

4300-TRM
Shower Valve Trim

4301-TRM
Shower Trim

4303-TRM
Hand Shower Trim

4305-TRM
Shower/Hand Shower Trim

4306-TRM
Tub/Shower/Hand Shower Trim

TRIM, TA-10, T-12A

4300TRMTC
Shower Valve Trim

4301TRMTC
Shower Trim

4303TRMTC
Hand Shower Trim

4305TRMTC
Shower/Hand Shower Trim

4306TRMTC
Tub/Shower/Hand Shower Trim

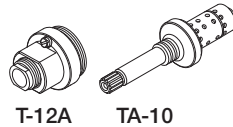

T-12A

TA-10

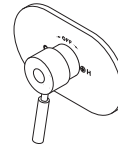

4300-TRM
4300TRMTC

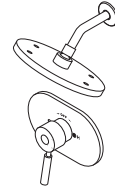

4301-TRM
4301TRMTC

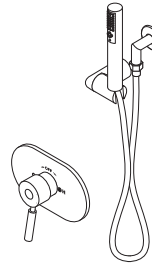

4303-TRM
4303TRMTC

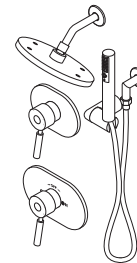

4305-TRM
4305TRMTC

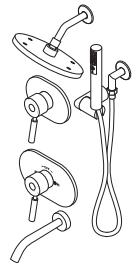

4306-TRM
4306TRMTC

Compliance

- ASME A112.18.1/CSA B125.1



Warranty

Limited Lifetime - to the original end purchaser in consumer/residential installations.

5 Years - for industrial/commercial installations.

Refer to www.symmons.com/warranty for complete warranty information.

Go to www.symmons.com/register to register your Symmons product.

1. Recommended Tools

FIGURE 1



2. Dimensions

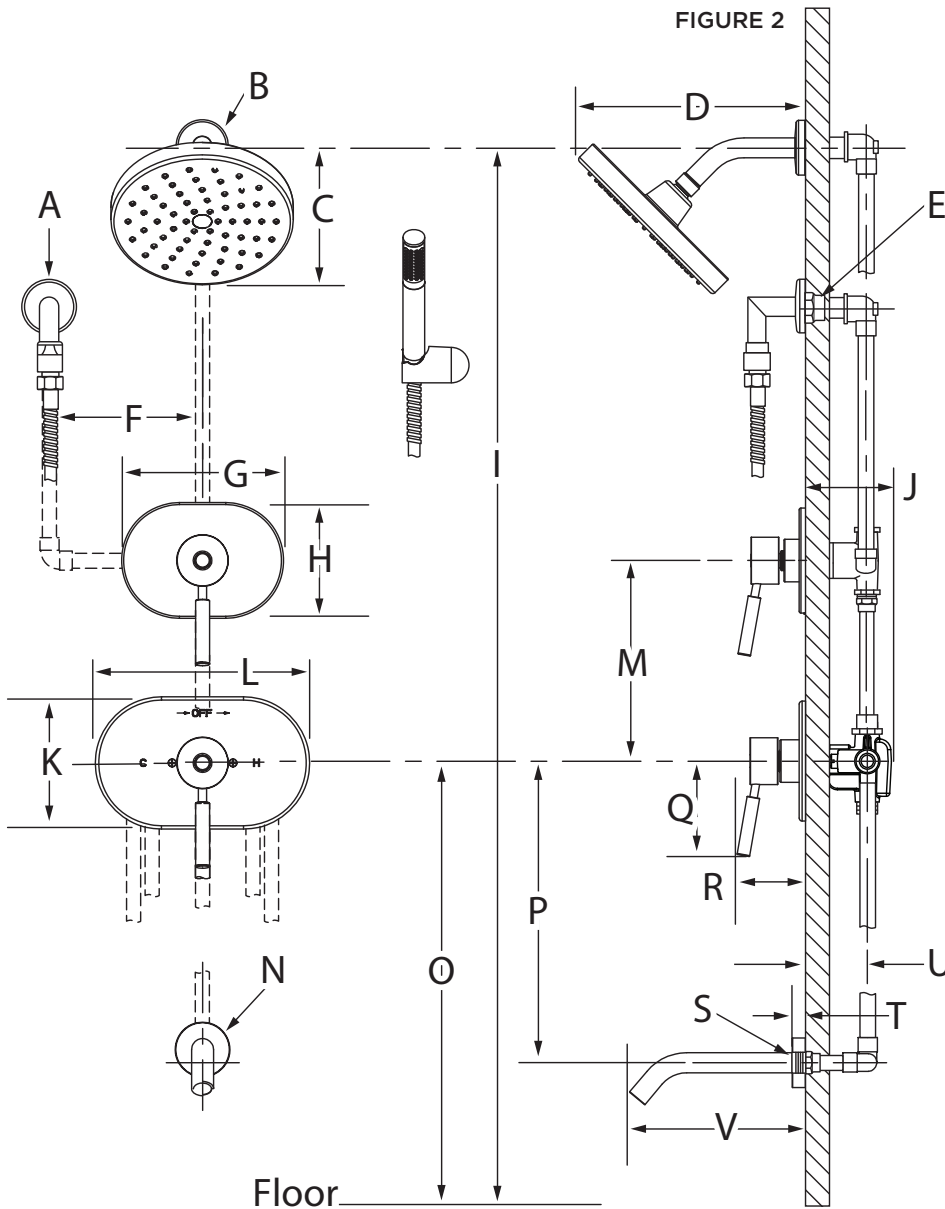

Measurements	
A	Ø 2-1/4", 57 mm
B	Ø 2-1/4", 57 mm
C	6", 152 mm
D	9-1/4", 235 mm
E	Female 1/2" IPS thread must be recessed 7/8" from finished wall
F	6", 152 mm right or left
G	7", 178 mm
H	5", 127 mm
I	77", 1956 mm
J	4-3/4", 121 mm
K	5-3/4", 146 mm
L	9-1/4", 235 mm
M	10", 254 mm
N	Ø 2-3/8", 60 mm
O	4300, 4301, 4303, 4305: Ref. 42", 1067 mm 4306: Ref. 32", 813 mm
P	12", 305 mm
Q	4-1/2", 114 mm
R	3-1/4", 83 mm
S	1/2" NPT
T	1/2", 13 mm
U	(Rough in) 2-3/8" ± 1/2", 60 mm ± 13 mm
V	8-1/2", 216 mm

Notes:

- 1) Valve body and piping not included and shown as reference only.
- 2) Plaster shield (p/n T-176) for dry wall, plaster or other type walls 1/2" or greater.
- 3) All dimensions measured from nominal rough-in (see U as reference).
- 4) Dimensions subject to change without notice.

3. Parts Breakdown (Model Numbers Ending in TRMTC)

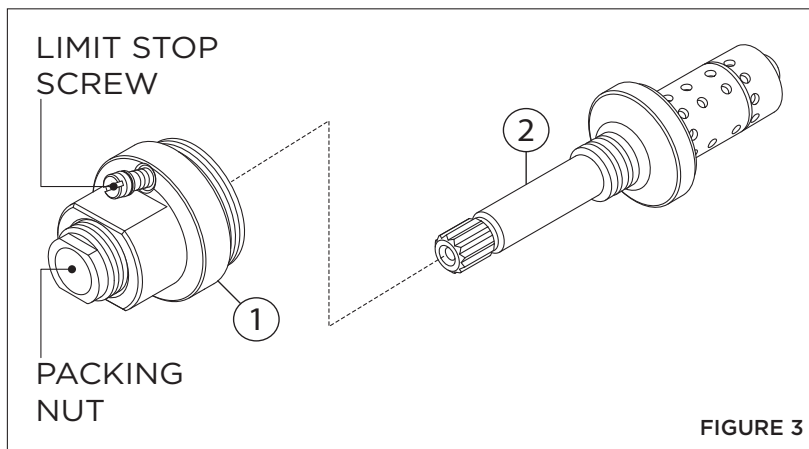

FIGURE 3

Replacement Parts		
Item	Description	Part Number
1	Cap Assy.	T-12A
2	Flow Control Spindle	TA-10

IMPORTANT: Model numbers ending in **TRMTC** coordinate with Temptrol pressure balancing valves ordered with Test Cap. The Test Cap is used to allow pressurization of system. **Do not** remove test cap from valve during wall construction, installation of valve or pressurization of system.

⚠ WARNINGS:

1. Do not expose valve with test cap to heat for longer than 2 minutes when soldering copper tubing. Doing so may damage the internal components of the valve and will void the product warranty.
2. Ensure test cap is **tightened securely** after soldering valve body.

4. Installation - Remove Test Cap (Model Numbers Ending in TRMTC)

Flow control spindle (TA-10) and cap assembly (T-12A) will come factory assembled for all model numbers ending in **TRMTC**. When ready to remove Test Cap and install trim, follow the instructions below:

- 1) Check for leaks around the valve assembly and all pipe fittings.
- 2) Remove test cap from valve (FIGURE 4.1).
- 3) If system is dirty, flush valve.
- 4) Thread flow control spindle and cap assembly into valve body. Turn clockwise to secure to valve (FIGURE 4.2).

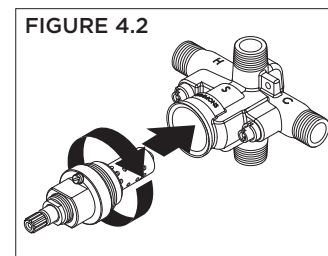
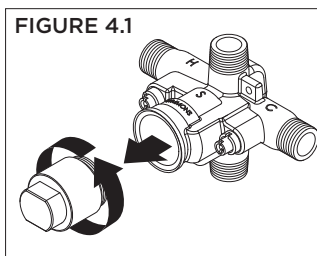

5. Installation - Adjust Packing Nut (Model Numbers Ending in TRMTC)

- 1) Turn hot and cold supplies on. Valve will not operate unless both hot and cold water supply pressures are on.
- 2) Place handle over flow control spindle.
- 3) Tighten packing nut for positive frictional resistance as handle is rotated from shut-off position across adjustment range.

6. Installation - Setting Limit Stop Screw (Model Numbers Ending in TRMTC)

The temperature limit stop screw limits valve handle from being turned to maximum position resulting in excessive hot water discharge temperatures.

⚠ WARNING: Failure to adjust limit stop screw properly may result in serious scalding.

- 1) Turn hot and cold supplies on. Valve will not operate unless both hot and cold water supply pressures are on.
- 2) Place handle on flow control spindle and open valve to maximum desired temperature.
- 3) Turn limit stop screw clockwise until it seats.

7. Parts Breakdown

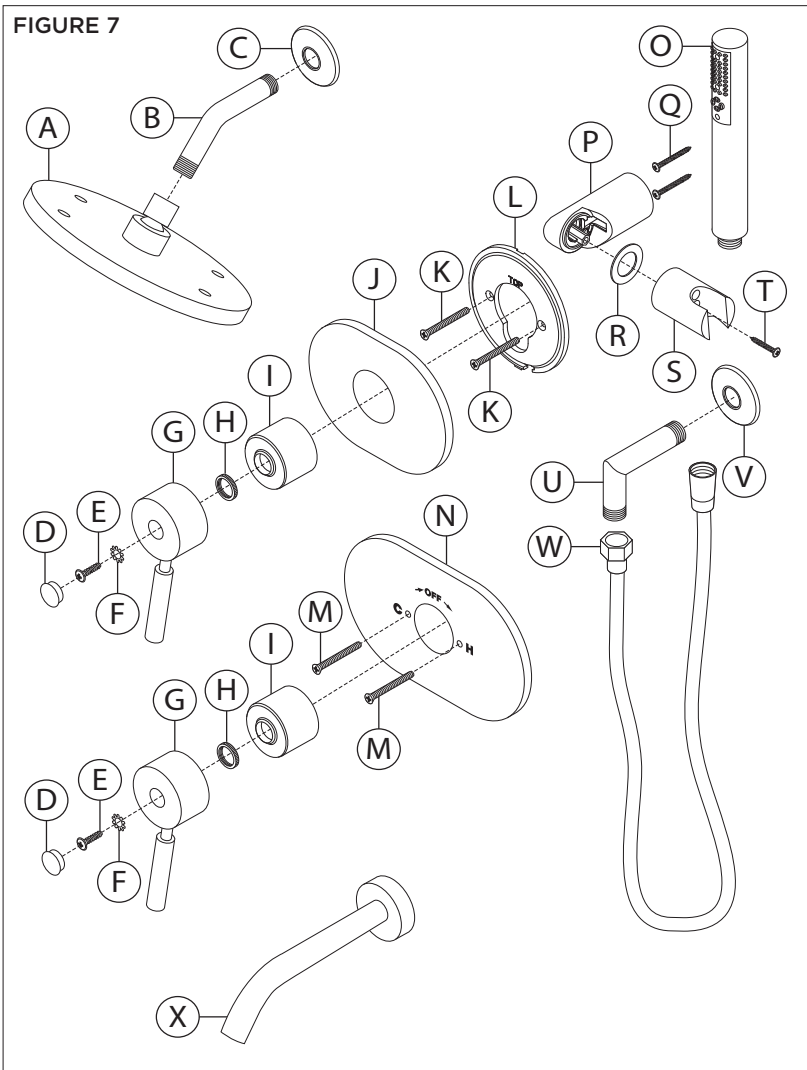

*Order in-line vacuum breaker (EF-109) for hand shower systems without dual checks.

Replacement Parts		
Item	Description	Part Number
A	Showerhead	432SH
B	Shower Arm	
C	Flange	300
D	Plug Button	
E	Screw	T-251
F	Star Washer	
G	Handle	
H	Lock Nut	T-19/20-PL
I	Dome Cover	
J	Diverter Escutcheon	
K	Screws	T-529
L	Mounting Plate	
M	Shower Escutcheon	
N	Screws	T-249
O	Hand Shower	432W
P	Cradle Mount	
Q	Cradle Mount Screws	
R	Washer	T-545
S	Cradle Arm	
T	Set Screw	
U	Wall Elbow	
V	Flange	T-444-KIT
W	60" Hose	RTS-045
X	Tub Spout	432TS

Notes:

- 1) Append appropriate suffix for premium finish.
- 2) Append appropriate flow rate to showerhead or hand shower for low flow.
- 3) Apply a bead of silicone around the perimeter of all shower trim installed flush to the finished wall. Leave opening on bottom of escutcheons for weep hole.
- 4) Apply plumber tape to threaded connections as necessary. DO NOT use plumber tape on fittings with face seal washers or o-rings.
- 5) DO NOT OVERTIGHTEN fittings with face seal washers or o-rings.

8. Installation - Shower Valve Trim

- 1) Secure large shower escutcheon to Temptrol pressure balancing valve using mounting screws (FIGURE 8.1).
- 2) Install dome cover and lock nut to valve by turning clockwise (FIGURE 8.2).
- 3) Install handle to shower valve. Secure with star washer, set screw and plug button (FIGURE 8.3).

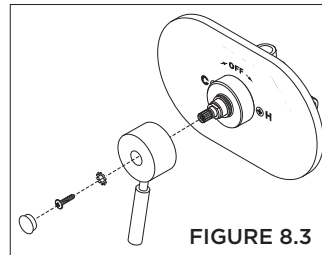
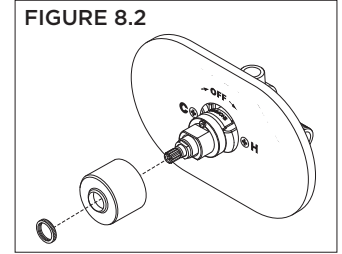
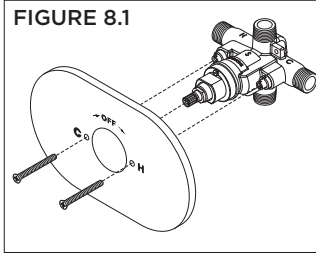

9. Installation - Diverter Valve Trim

- 1) Secure small mounting plate to Symmons diverter valve using mounting screws (FIGURE 9.1).
- 2) Secure small diverter escutcheon to mounting plate. Tabs should snap in place (FIGURE 9.2).
- 3) Install dome cover and lock nut to valve by turning clockwise (FIGURE 9.3).
- 4) Install handle to diverter valve. Secure with star washer, set screw and plug button (FIGURE 9.4).

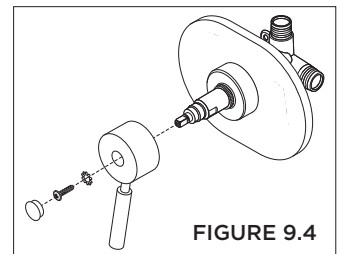
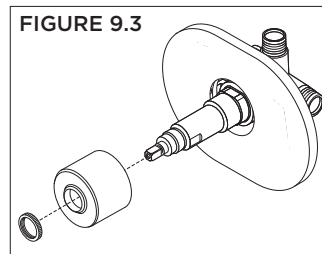
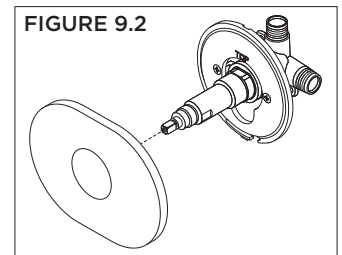
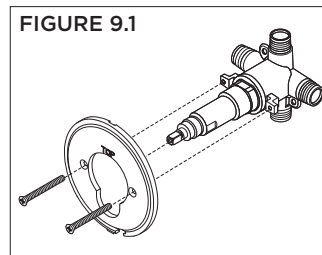

10. Installation - Showerhead & Tub Spout

- 1) Attach shower arm and flange to shower pipe. Turn clockwise to tighten (FIGURE 10.1).
- 2) Install showerhead to shower arm. Turn clockwise to tighten (FIGURE 10.2).
- 3) Install tub spout to stub out pipe. Turn clockwise to tighten (FIGURE 10.3).

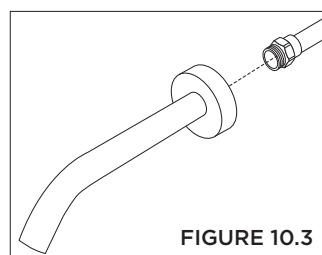
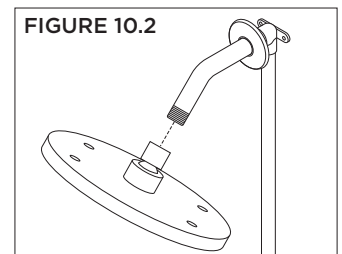
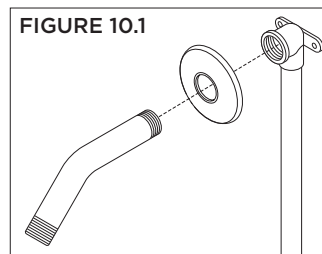

11. Installation - Slide Bar Assembly

- 1) Press tab to remove mounting plate from cradle mount cover (FIGURE 11.1).
Note: Mounting plate center tabs must be horizontal for removal.
- 2) Place mounting plate in position, mark and drill 3/16" holes into drywall. Install anchors (FIGURE 11.2).
Stud Option: Place mounting plate in position, mark and drill 1/8" pilot holes into stud.
- 3) Install mounting plate. Secure with two screws. Replace cradle mount cover (FIGURE 11.3).
Note: Mounting plate center tabs must be horizontal for installation.
- 4) Attach cradle arm and washer to cradle mount. Secure with set screw (FIGURE 11.4).
- 5) Install wall elbow and flange to recessed pipe fitting. Turn elbow clockwise to tighten (FIGURE 11.5).
- 6) Attach small end of hand shower hose to wall elbow. Turn clockwise to tighten (FIGURE 11.6).
- 7) Attach large end of hand shower hose to hand shower wand. Turn clockwise to tighten (FIGURE 11.7).

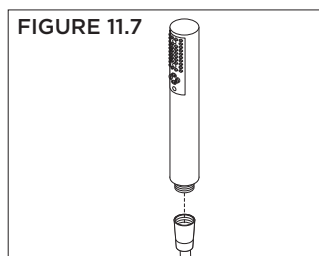
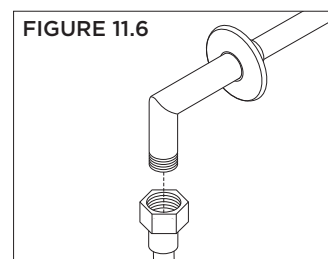
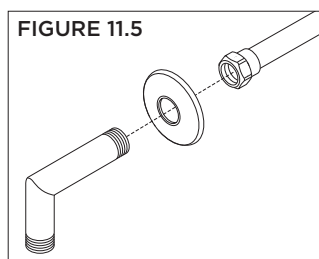
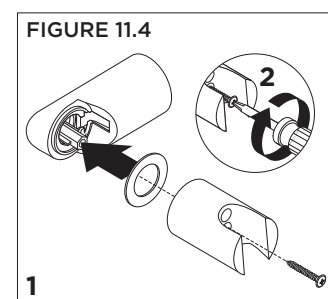
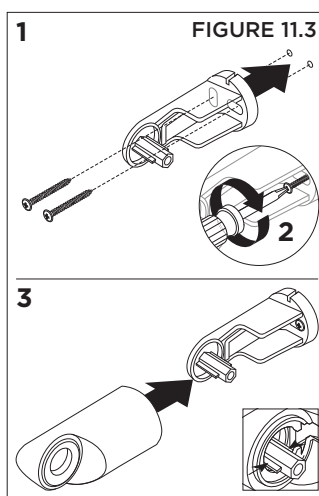
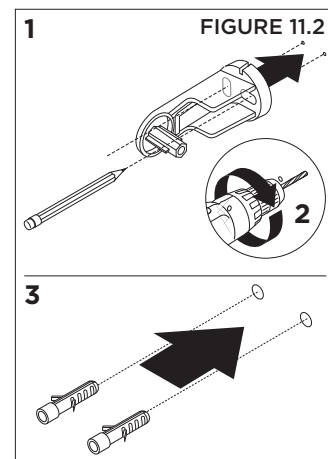
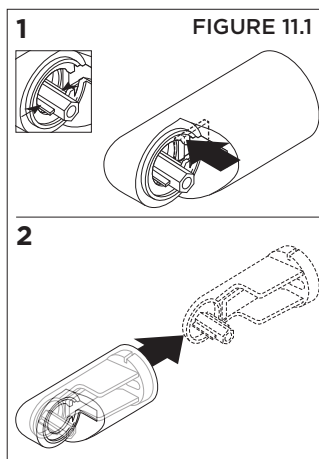

12. Operation (Temperature Control)

- 1) Turn shower handle counter-clockwise approximately 1/4 turn to put valve in cold position (FIGURE 12.1).
- 2) Turn shower handle counter-clockwise approximately 1/2 turn to put valve in warm position (FIGURE 12.2).
- 3) Turn shower handle counter-clockwise approximately 3/4 turn to put valve in hot position (FIGURE 12.3).

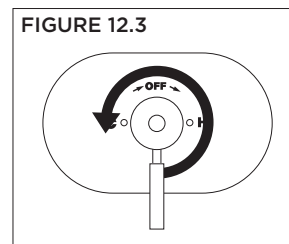
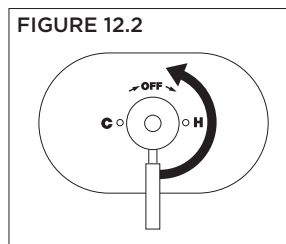
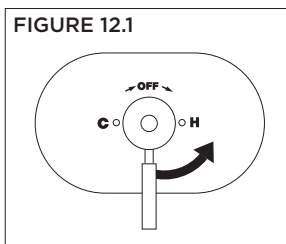

13. Operation (Dual Outlet Diverter Control)

Note: Additional handle positions for same output are illustrated.

- 1) Cartridge is factory set to divert to function 1 (FIGURE 13.1).
- 2) Turn handle to position 2 to divert to function 2 (FIGURE 13.2).
- 3) Turn handle to position 3 to share functions 1 and 2 (FIGURE 13.3).

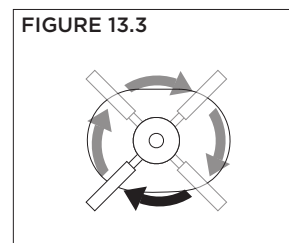
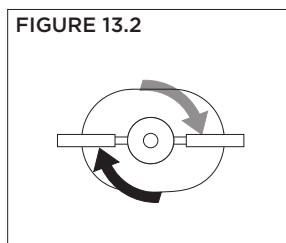
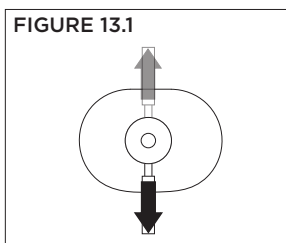

14. Operation (Triple Outlet Diverter Control)

- 1) Cartridge is factory set to divert to function 1 (FIGURE 14.1).
- 2) Turn handle to position 2 to divert to function 2 (FIGURE 14.2).
- 3) Turn handle to position 3 to divert to function 3 (FIGURE 14.3).
- 4) Turn handle to position 4 to share functions 2 and 3 (FIGURE 14.4).
- 5) Turn handle to position 5 to share functions 1 and 3 (FIGURE 14.5).
- 6) Turn handle to position 6 to share functions 1 and 2 (FIGURE 14.6).

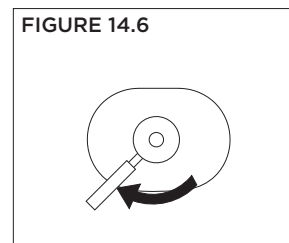
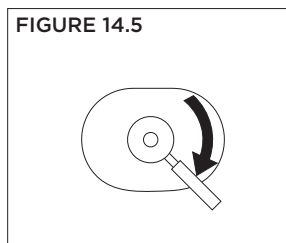
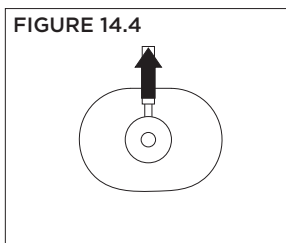
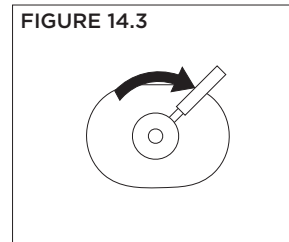
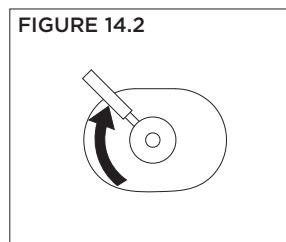
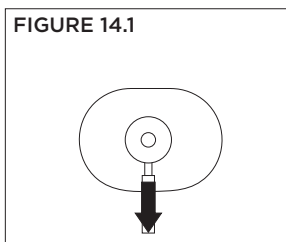

15. Troubleshooting Chart

Problem	Cause	Solution
Finish is spotting.	Elements in water supply may cause water staining on finish.	Clean finished trim area with a soft cloth using mild soap and water or a non-abrasive cleaner and then quickly rinse with water.

 **WARNING:** This product can expose you to chemicals including lead, which is known to the state of California to cause cancer, birth defects, or other reproductive harm. For more information, go to www.P65Warnings.ca.gov.