





Specification:

1. Material: MDF + Plywood + Birch
2. Finish: See Table
3. Hardware: See Table
4. Slides: USE58-300-18 + USCLIP2ND-4W( 2 Set )
5. Hinge: 700.0536.25 + 600.1234.05 ( 2 Set )
6. The tolerance is +/- 1/8"

Item number	Finish	Deco Hardware	
		Item number	Qty
VN2KAT-30-BK-NT	Black	845-160PC	3
VN2KAT-30-BL-NT	Blue	845-160SBZ	3
VN2KAT-30-BS-NT	Blue Steel	845-160BG	3
VN2KAT-30-GN-NT	Green	845-160SBZ	3
VN2KAT-30-GR-NT	Grey	845-160MB	3
VN2KAT-30-WH-NT	White	845-160MB	3

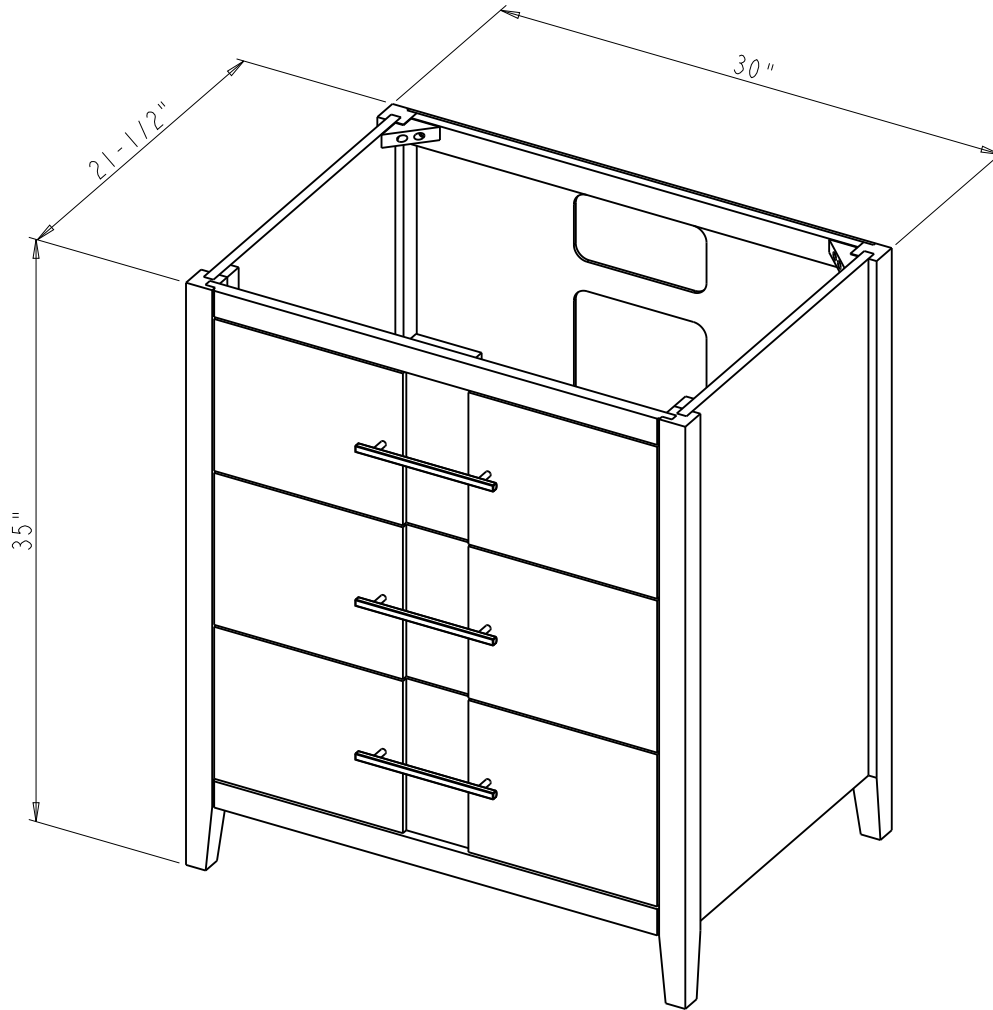
 <p><b>PROPRIETARY AND CONFIDENTIAL</b></p> <p>THE INFORMATION CONTAINED IN THIS DRAWING IS THE SOLE PROPERTY OF HARDWARE RESOURCES INC. ANY REPRODUCTION IN PART OR AS A WHOLE WITHOUT THE WRITTEN PERMISSION OF HARDWARE RESOURCES INC. IS PROHIBITED.</p> <p>DO NOT SCALE DRAWING</p>	ITEM#: VN2KAT-30	MATERIAL:	
	FINISH:	WEIGHT: 9	
	TOLERANCE UNLESS OTHERWISE SPECIFIED: X ±0.20 X.X ±0.10 X.XX ±0.05 ANGULAR: ±0.5°	UNITS: DRAWN BY: <b>Tony.Huang</b>	DATE: Nov-22-21
	SHEET:	APPROVED BY:	DATE:
	RELEASE LEVEL:	REVISION:	



 <p><b>PROPRIETARY AND CONFIDENTIAL</b></p> <p>THE INFORMATION CONTAINED IN THIS DRAWING IS THE SOLE PROPERTY OF HARDWARE RESOURCES INC. ANY REPRODUCTION IN PART OR AS A WHOLE WITHOUT THE WRITTEN PERMISSION OF HARDWARE RESOURCES INC. IS PROHIBITED.</p>	ITEM#: VN2KAT - 30		MATERIAL:	
	FINISH:		WEIGHT: 9	
	TOLERANCE UNLESS OTHERWISE SPECIFIED: X ±0.20 X.X ±0.10 X.XX ±0.05 ANGULAR: ±0.5°		UNITS:	
DO NOT SCALE DRAWING		SIZE:	DRAWN BY: <i>Hugo.cai</i>	DATE: Nov-16-23
		SHEET:	APPROVED BY:	DATE:
		RELEASE LEVEL:	REVISION:	

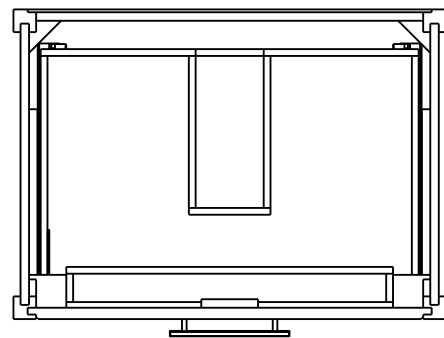
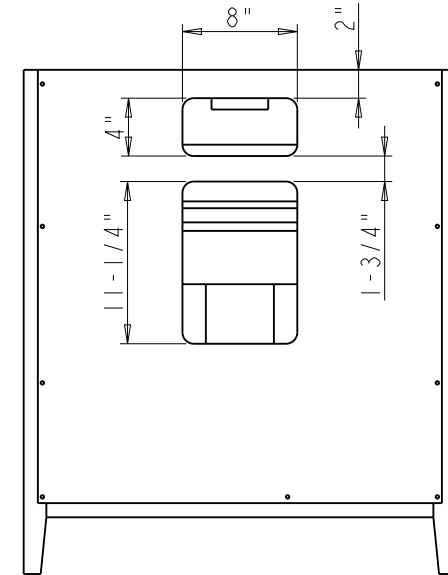
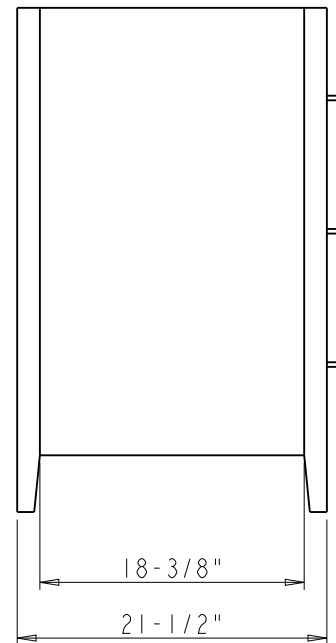
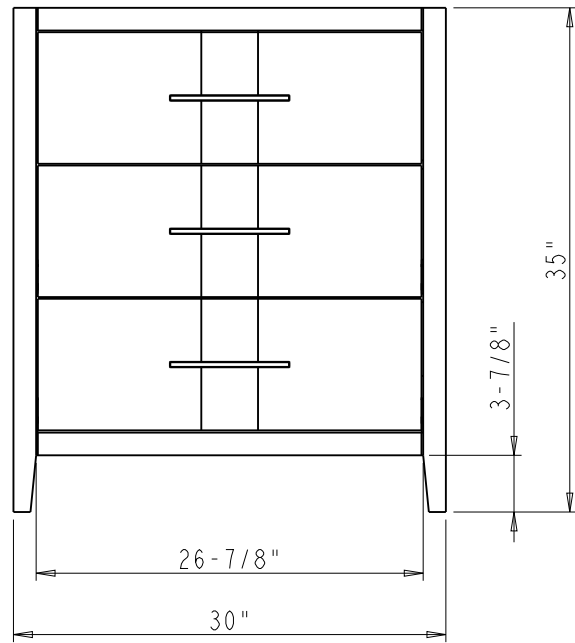

 <p><b>PROPRIETARY AND CONFIDENTIAL</b></p> <p>THE INFORMATION CONTAINED IN THIS DRAWING IS THE SOLE PROPERTY OF HARDWARE RESOURCES INC. ANY REPRODUCTION IN PART OR AS A WHOLE WITHOUT THE WRITTEN PERMISSION OF HARDWARE RESOURCES INC. IS PROHIBITED.</p> <p>DO NOT SCALE DRAWING</p>	ITEM:	VN2KAT - 30	MATERIAL:	
	FINISH:		WEIGHT:	
	TOLERANCE UNLESS OTHERWISE SPECIFIED:	UNITS:	DRAWN BY:	DATE:
	SIZE:	APPROVED BY:	DATE:	
	SHEET:	RELEASE LEVEL:	REVISION:	



*Hugo.cai* Nov-16-23