

# TABLE ASSEMBLY INSTRUCTIONS

LEG  
(4 PIECES)

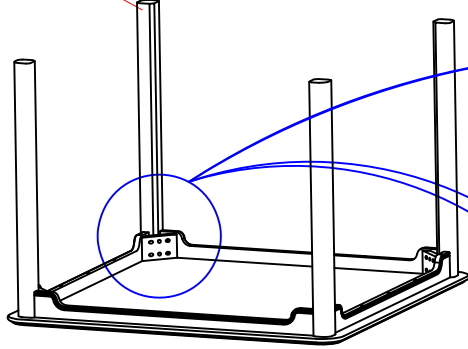

TABLE  
TOP

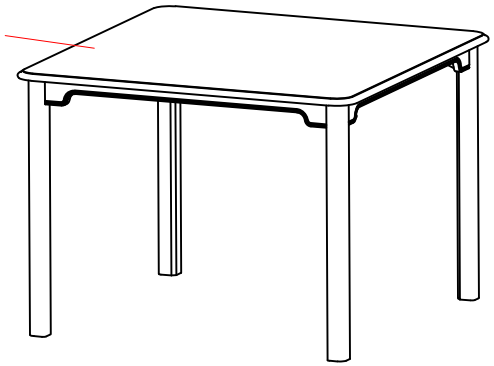
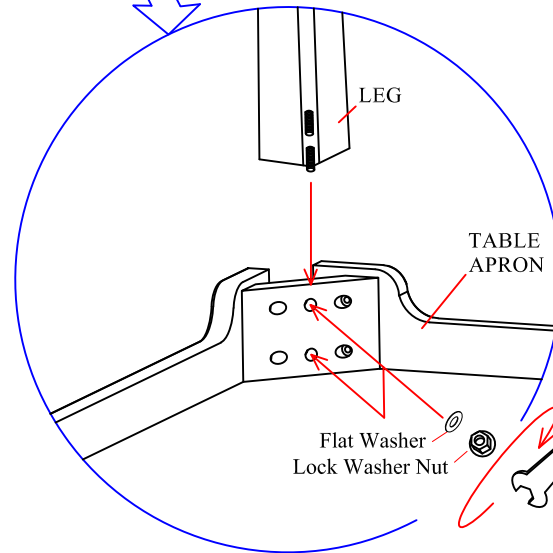
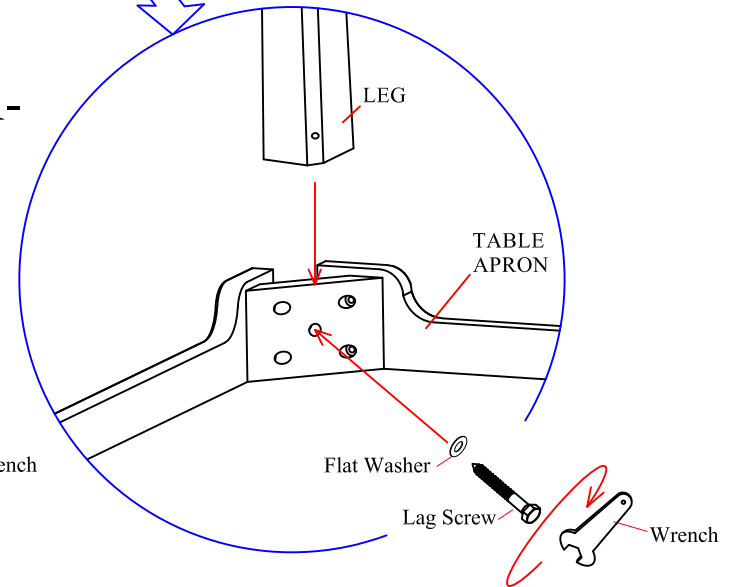



Table Top and Legs shown for assembly purposes only and may not exactly match your style of table.



-OR-





**PARTS LIST (INCLUDED)**

	Lock Washer Nut	8 pieces
	Flat Washer	8 pieces

WRENCH REQUIRED FOR ASSEMBLY (NOT INCLUDED)

**PARTS LIST (INCLUDED)**

	Lag Screw	4 pieces
	Flat Washer	4 pieces

WRENCH REQUIRED FOR ASSEMBLY (NOT INCLUDED)

- Place the Table Top face down on a soft clean surface.
- Attach the Legs to the Table Apron at the corners as shown.
- Position the table upright.
- Periodically check that all the connections are tight and secure.