

# 0.5X4 LED SKYLIGHT FLAT PANEL FIXTURE WITH SELECTABLE COLOR TEMPERATURES

---

## IMPORTANT SAFETY INSTRUCTIONS AND INSTALLATION GUIDE

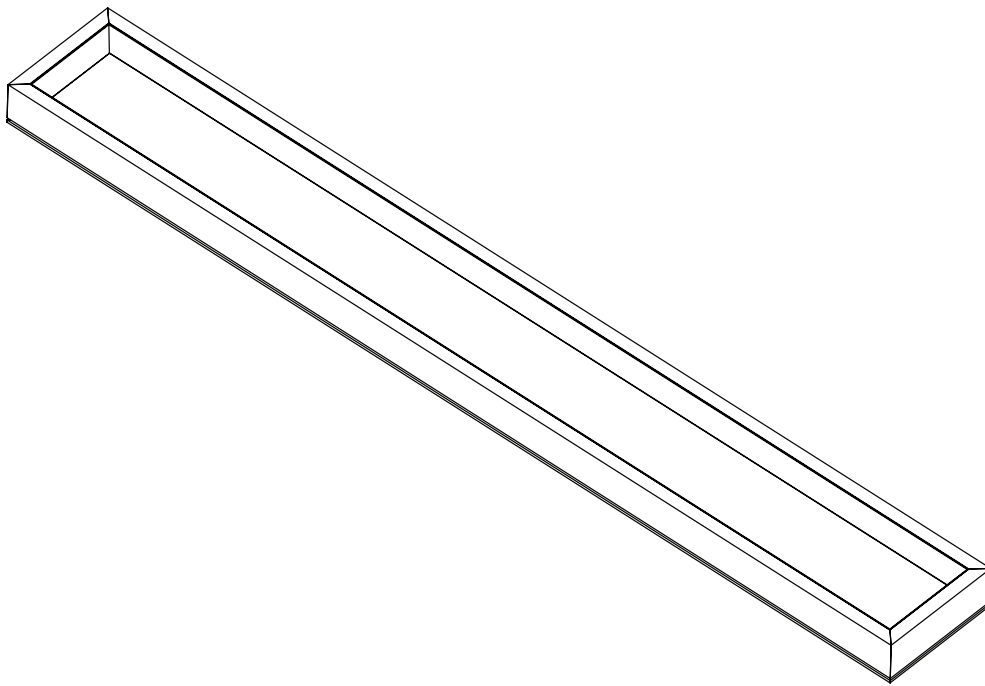

**READ BEFORE INSTALLATION**  
**SAVE THESE INSTRUCTIONS**



# Table of Contents

Safety Information .....	2
FCC Statement .....	2
Warranty .....	2
Pre-Assembly .....	3
Option 1: Junction Box Installation .....	4-5
Option 2: Canless Installation .....	6
Operating the Fixture .....	7
Changing the Color Settings .....	7

## Safety Information

For your safety, always remember to:

- Turn off the power supply at the fuse or circuit breaker box before you install the fixture.
- Ground the fixture to avoid potential electric shock and to ensure reliable starting.
- Double-check all connections to be sure they are tight and correct.
- Wear rubber soled shoes and work on a sturdy wooden ladder.
- Account for small parts and destroy packing material, as these may be hazardous to children.

This fixture is designed for use in a circuit protected by a fuse or circuit breaker. It is also designed to be installed in accordance with local electrical codes. If you are unsure about your wiring, consult a qualified electrician or local electrical inspector, and check your local electrical code.

**NOTICE:** All electrical connections must be in accordance with local and National Electrical Code (N.E.C.) standards. If you are unfamiliar with proper electrical wiring connections obtain the services of a qualified electrician.

Remove the fixture and the mounting package from the box and make sure that no parts are missing by referencing the illustrations on the installation instructions.

### Product Specifications:

- 120VAC, 40W, 60Hz
- Wall Dimmable
- Suitable for Damp Location
- Intended to be mounted on the ceiling or wall surface



**WARNING: RISK OF SHOCK.** House electric current can cause painful shock or serious injury unless handled properly.



**CAUTION:** Turn off the main power at the circuit breaker before installing the fixture, in order to prevent possible shock.



**WARNING: RISK OF FIRE.** Before installing your lighting fixture, thoroughly review this installation manual. If you do not have sufficient electrical wiring experience have your fixture installed by a certified electrician. All electrical connections must be in accordance with Local and National Electrical Code (NEC) Standards. Reliable operating temperature is -13°F to 113°F / -25°C to 45°C. Suitable for Damp Locations. For more information including dimmer compatibility visit [www.feit.com](http://www.feit.com).

**SUITABLE FOR OPERATION IN AMBIENT NOT EXCEEDING 45°C**

## FCC STATEMENT

**Supplier's Declaration of Conformity:**  
47 CFR § 2.1077 Compliance Information  
**Responsible Party:** Feit Electric Company  
4901 Gregg Road, Pico Rivera, CA 90660, USA  
[www.feit.com](http://www.feit.com)  
**Unique Identifier:** FP0.5X4/SKY/5CCT/WH

This device complies with part 15 of the FCC Rules. Operation is subject to the following two conditions: (1) This device may not cause harmful interference, and (2) this device must accept any interference received, including interference that may cause undesired operation. Note: This equipment has been tested and found to comply with the limits for a Class B digital device, pursuant to part 15 of the FCC Rules. These limits are designed to provide reasonable protection against harmful interference in a residential installation. This equipment generates, uses and can radiate radio frequency energy and, if not installed and used in accordance with the instructions, may cause harmful interference to radio communications. However, there is no guarantee that interference will not occur in a particular installation. If this equipment does cause harmful interference to radio or television reception, which can be determined by turning the equipment off and on, the user is encouraged to try to correct the interference by one or more of the following measures: Reorient or relocate the receiving antenna. Increase the separation between the equipment and receiver. Connect the equipment into an outlet on a circuit different from that to which the receiver is connected. Consult the dealer or an experienced radio/TV technician for help. Any changes or modifications not expressly approved by the manufacturer could void the user's authority to operate the equipment.

## Limited Warranty

This product is warrantied to be free from defects in workmanship and materials for up to 3 years from date of purchase. If the product fails within the warranty period, please contact Feit Electric at [info@feit.com](mailto:info@feit.com) or visit [feit.com/contact-us](http://feit.com/contact-us) for instructions on replacement or refund. REPLACEMENT OR REFUND IS YOUR SOLE REMEDY. EXCEPT TO THE EXTENT PROHIBITED BY APPLICABLE LAW, ANY IMPLIED WARRANTIES ARE LIMITED IN DURATION TO THE DURATION OF THIS WARRANTY. LIABILITY FOR INCIDENTAL OR CONSEQUENTIAL DAMAGES IS HEREBY EXPRESSLY EXCLUDED. Some states and provinces do not allow the exclusion of incidental or consequential damages, so the above limitation or exclusion may not apply to you. This warranty gives you specific legal rights, and you may also have other rights which vary from state to state or province to province.

## TOOLS REQUIRED (NOT INCLUDED)

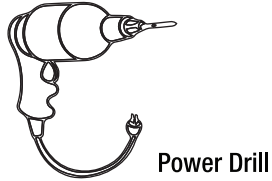
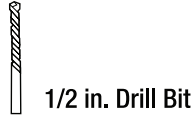
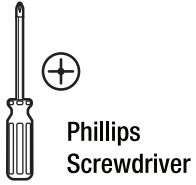

## HARDWARE INCLUDED



NOTE: Hardware not shown to actual size.

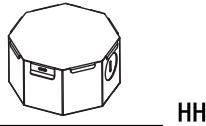
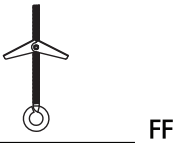
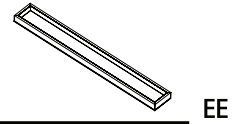
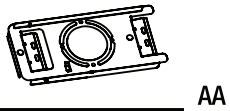

Part	Description	Quantity
AA	Mounting Plate (8.03 in. x 3.74 in. x 0.49 in.)	1
BB	3/16 in. Bolts	2
CC	Wire Nuts	3
DD	Screws #8-32 x 1 in.	2
EE	LED Flat Panel	1
FF	3/16 in. Eye Bolts with Wing Nuts	1
GG	Spring Clips	4
HH	Junction Box	1
II	Screws #0.12 x 0.12 in.	2
JJ	Screws #0.16 x 0.22 in.	8

# Option 1: Junction Box Installation

## 1 Turning off the Power

- Turn the power OFF at the switch, fusebox, or the circuit breaker.

## 2 Identifying the Wires

Black - Hot/Live  
White - Neutral  
Green or Bare Copper - Ground

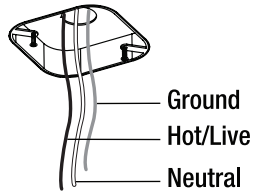

## 3 Removing the Mounting Plate

- Slide the mounting plate (AA) in the opposite direction of the arrow shown on the fixture label.
- Unattach the swing arms from the mounting plate (AA).

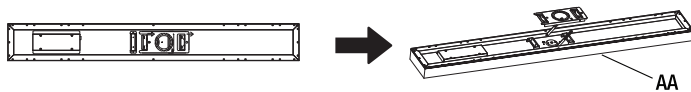

## 4 Positioning the Toggle Bolts

- Align the mounting plate (AA) center opening over the junction box in the direction you want the fixture (EE) to be aligned.
- Once the direction is established, use the mounting plate (AA) as a guide, and mark the position of the holes where the toggle bolts will be placed.

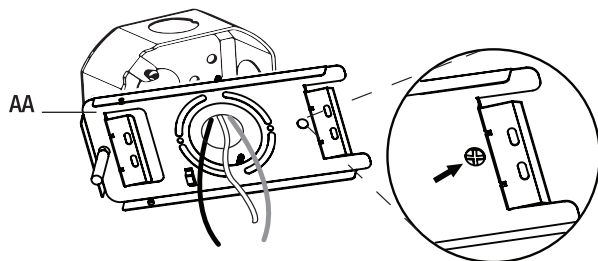

**NOTE:** Once the toggle bolts are installed, you cannot change the orientation.

## 5 Securing the Toggle Bolts

- Drill the marked locations using a 1/2 in. drill bit.
- Remove the wings from the 3/16 in. toggle bolts (BB).
- Insert the toggle bolt (BB) through the front of the mounting plate (AA) and reattach the wing to the toggle bolt (BB). Repeat for all toggle bolts.

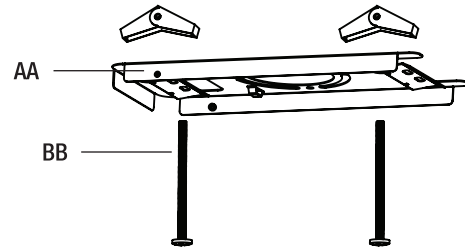

## 6 Re-attaching the Mounting Plate

- Feed the junction box wires through the center of the mounting plate (AA) hole.
- Re-attach the mounting plate (AA) by inserting the toggle bolts (BB) into the drilled holes.
- Once the wings (BB) are through and expanded, pull the toggle bolts (BB) downward to engage and tighten.

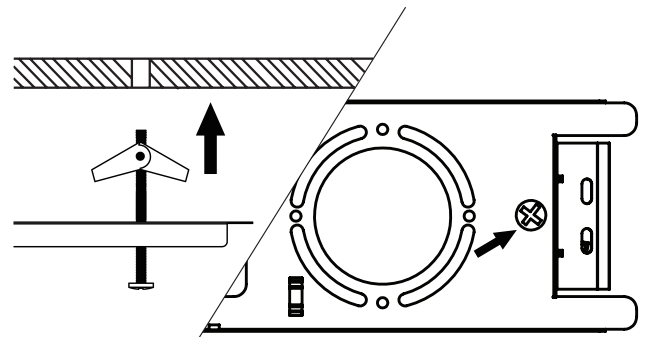

## 7 Connecting the Fixture

- Hook the support wire from the fixture (EE) on the mounting plate (AA).

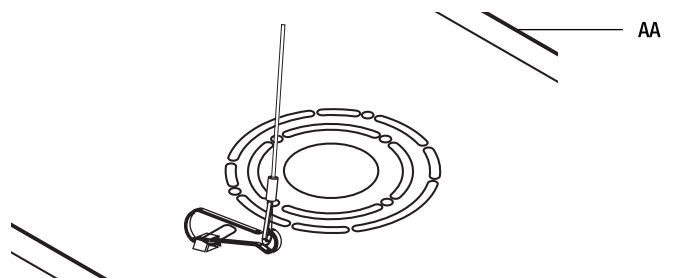

## 8 Installing the Fixture

- Connect the three wires coming from the fixture (EE) to the junction box wires (black - line voltage, white - neutral and green - ground).

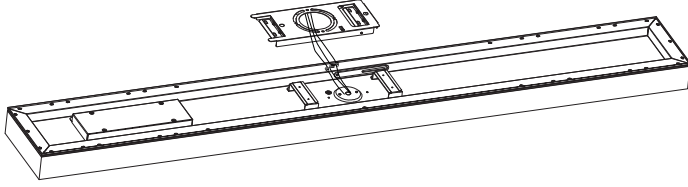

**NOTE:** Before attaching the fixture, select the preferred color temperature on the back of the fixture. See “Changing Color Settings” for details.

## Connecting the Swing Arms

- ### 9
- Insert the swing arm’s key hole slot into the mounting plate’s hanging screw.

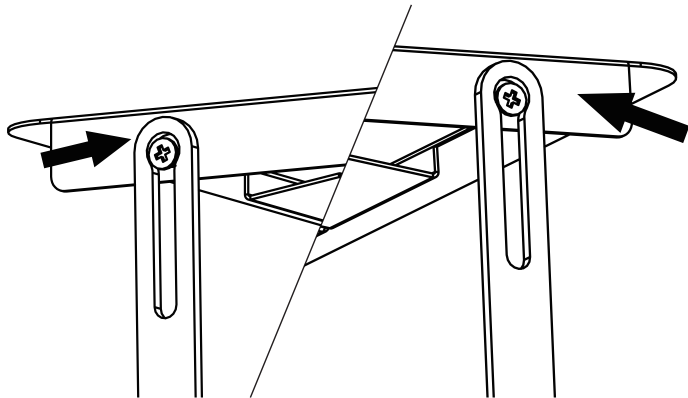

## 10 Attaching the Fixture

- Feed the junction box and fixture (EE) wires through the mounting plate’s center hole.
- Raise the fixture (EE) to the direction of the arrow on the swing arm.

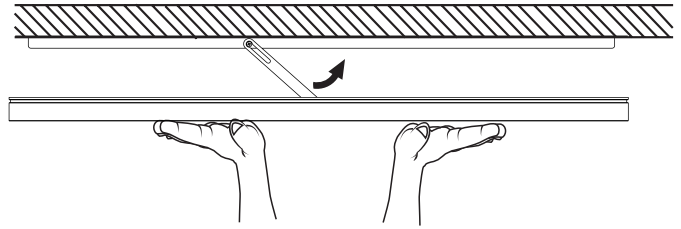

## 11 Securing the Fixture

- Once the fixture (EE) has been raised and is flush to the ceiling, lock the fixture (EE) by moving it towards the opposite direction it was raised (as shown on the fixture label).

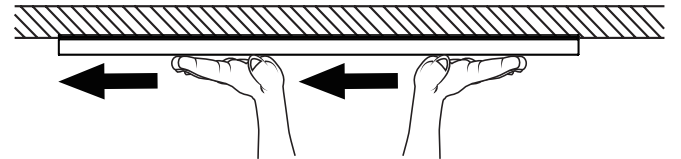

## 12 Turning on the Power

- Turn on the fusebox or circuit breaker and the power at the wall switch.

# Option 2: Canless Installation

## 1 Cutting Ceiling Openings for Fixture Installation

- Carefully measure where each fixture (EE) will be installed. Use the provided cutout template to mark your hole locations.
- Cut a 4 in. hole and a 5/8 in. hole in the ceiling as round as possible using a recessed lighting hole saw.
- Cut 4 rectangular holes in the ceiling as accurate as possible using a drywall saw and the provided cutout template.



**NOTE:** Use a stud finder before cutting to ensure that the hole does not impinge on joists, pipe work, cable or other building services.



**NOTE:** If the hole does not conflict with joists, use the cutouts labeled "1" for the rectangular holes. If the hole does conflict with joists, use the cutouts labeled "2" for the rectangular holes.

## 2 Removing the Mounting Plate

- Slide the mounting plate (AA) in the opposite direction of the arrow shown on the fixture label.
- Unattach the swing arms from the mounting plate (AA).



## 3 Installing the Spring Clips and Junction Box

- Attach the spring clips (GG) on back of the fixture (EE), aligning to the slots where you cut out the rectangular holes.
- Securely screw the Junction Box (HH) onto the back of the fixture (EE).
- Gently extract the knockout from the junction box (HH) using a screwdriver or punch driver.

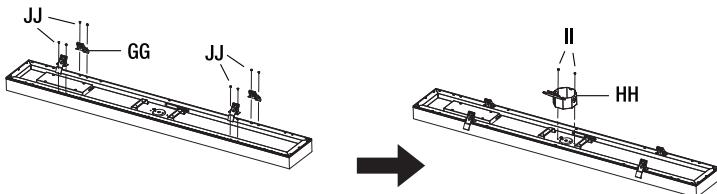

## 4 Connecting the Fixture

- Insert the eye bolt screw with the wing nut (FF) through the 5/8 in. hole. Once the wing is through and expanded, pull the eye hook downward to engage and tighten.
- Hook the safety cable from the fixture (EE) onto the eye hook (FF).

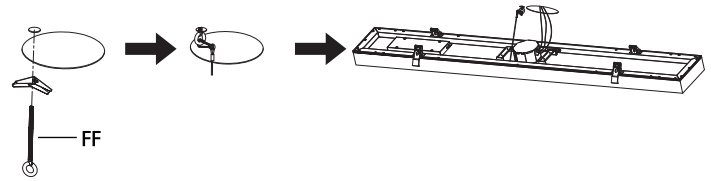

## 5 Installing the Fixture

- Open the junction box (HH) cover. Feed the supply wires into the knockout.
- Using the wire nuts (CC), connect the three wires coming from the fixture to the supply wires (black - line voltage, white - neutral and green/bare copper - ground).

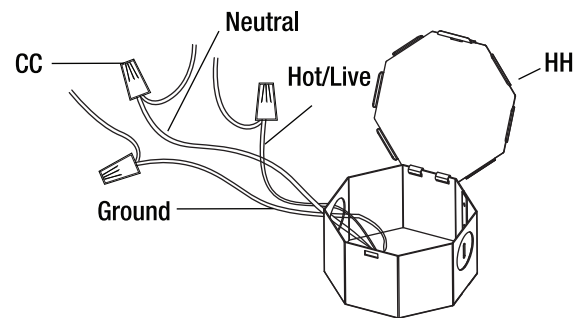

## 6 Attaching the Fixture

- Hold the spring clips against the fixture (EE) and gently guide into the ceiling until the clips snap into place. The fixture (EE) should be flush with the ceiling.

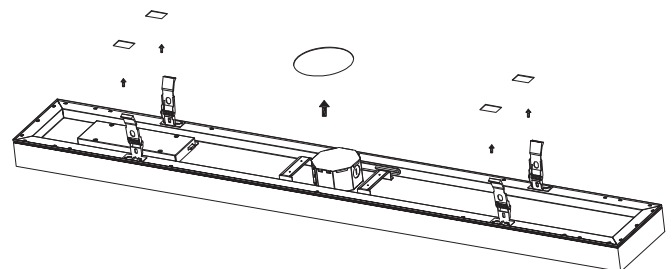

## 7 Turning on the Power

- Turn on the fusebox or circuit breaker and the power at the wall switch.

## Operating the Fixture

- Flip the wall switch ON after Installation to enter Mode 1: Skylight.
- Flip the wall switch OFF and back ON in less than 3 seconds to enter the Mode 2: White light.
  - The color temperature of the white light in Mode 2 can be selected with the switch on the back of fixture. This will affect the color temperature of the white light only in Mode 2. See "Changing the Color Settings" section.
- Flip the wall switch OFF and back ON again in less than 3 seconds to enter Mode 3: Blue light.



**NOTE:** If the unit is turned off for more than 10 seconds, the mode will automatically revert to the default mode of Mode 1 (Skylight).

## Changing the Color Settings

- Must be in Mode 2 (White light) to select the desired color temperature.

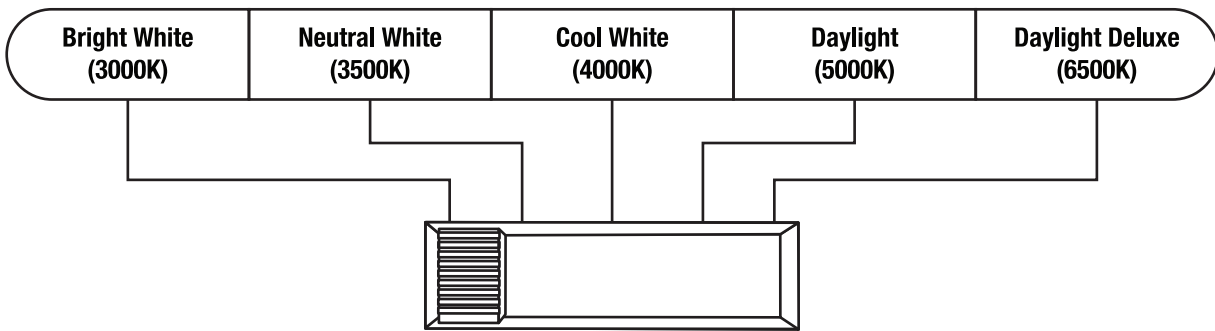

When the slide switch is set to 3000K, the color temperature is set to Bright White.

When the slide switch is set to 3500K, the color temperature is set to Neutral White.

When the slide switch is set to 4000K, the color temperature is set to Cool White.

When the slide switch is set to 5000K, the color temperature is set to Daylight.

When the slide switch is set to 6500K, the color temperature is set to Daylight Deluxe.



**NOTE:** The color temperature is pre-set to 4000K.



## Need Help?

Thank you for your purchase.  
Questions, comments or feedback?  
We'd love to hear from you.

Visit [feit.com/help](https://feit.com/help) for support or connect with us:



@FeitElectric



@FeitElectricInc



feitelectriclighting