



MWHHM
UHF 100 Frequency
Wireless Handheld Microphone



1601 Jack McKay Blvd. • Ennis, Texas 75119 U.S.A.
Telephone: 800.876.3333 • Fax: 800.765.3435

Description

The AtlasIED MWHHM wireless handheld microphone is the ideal choice for a variety of applications ranging from classrooms and conference rooms to lecture halls and live presentations. The MWHHM features a dynamic/condenser type microphone element in a sturdy enclosure that is lightweight and ergonomically designed for comfort. The unit is powered by either standard AA batteries or with NiMH rechargeable batteries (sold separately) allowing for up to 16 hours of usage. The unit operates on the UHF band and syncs to the wireless receiver, AtlasIED model MWRCVR, for connection to local amplification. The integrated LCD displays critical information regarding channel, frequency, and battery level. An optional charger is available when used with NiMH rechargeable batteries, AtlasIED model MWCHGR.

Features

- Multi-function LCD display for channel / frequency, battery level indicator, Alkaline / NiMH battery selection
- Patented technology for 2-way data transfer between transmitter and receiver
- Hidden antenna
- Detachable microphone capsule design
- Rugged metal housing design
- Requires 2 AA batteries to operate
- Up to 16 hours operating time
- Matching battery charger: MWCHGR

Applications

- Classrooms
- Conference Rooms
- Lecture Halls
- Live Presentation



1601 Jack McKay Blvd. • Ennis, Texas 75119 U.S.A.
Telephone: 800.876.3333 • Fax: 800.765.3435

Parts and Functions

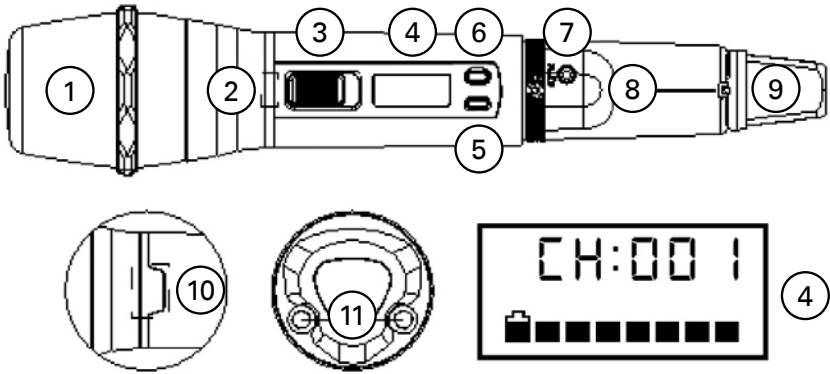

1. Cartridge
2. Battery Power LED
3. Power Switch
4. LCD Display
5. Menu Button
6. Setting Button
7. Synchronizing Button
8. Battery Compartment
9. Color Cap
10. Sensor Area
11. Charging Contacts



1601 Jack McKay Blvd. • Ennis, Texas 75119 U.S.A.
Telephone: 800.876.3333 • Fax: 800.765.3435

Battery Indicator & Installation

The MWHHM handheld microphone requires two (2) AA batteries to operate. Open the battery cover and insert the batteries into the battery compartment.

Note: Batteries contain a corrosive acid that may leak and damage the microphone when stored for a long period. Batteries should be removed from the microphone before storing for more than four weeks.

When the microphone is switched ON, the battery power LED (blue) will blink once to denote the batteries installed are in good condition. If the LED remains illuminated the batteries require replacement.

Important: Use only NiMH rechargeable batteries when using non-alkaline type batteries. Lithium Ion or other rechargeable batteries are not compatible with the MWBPT. NiMH must be selected when using rechargeable batteries. Never select AKLN (alkaline) when using rechargeable batteries. Incorrect battery selection will cause inaccurate battery information to be displayed.



1601 Jack McKay Blvd. • Ennis, Texas 75119 U.S.A.
Telephone: 800.876.3333 • Fax: 800.765.3435

Synchronizing Channels on the Receiver and Transmitter

Align infrared areas of the receiver and transmitter within 12" (30cm).

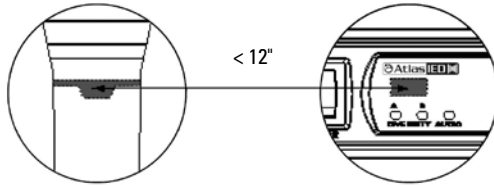

Figure 2

A. Changing the receiver's channel

1. Press the synchronizing button on the microphone (Fig 3).
2. The microphone's LED will illuminate, indicating the frequency is being transmitted to the receiver and that the receiver is synchronizing channels with the microphone (Fig 4).

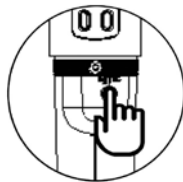

Figure 3



Figure 4

B. Changing the microphone's channel

1. Press the synchronizing button on the receiver (Fig 5).
2. The receiver's LED will illuminate, indicating the frequency is being transmitted to the microphone and that the microphone is synchronizing channels with the receiver (Fig 6).

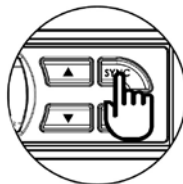

Figure 5



Figure 6

If this does not synchronize the channels, ensure the IR sensor panels are properly aligned and are located within 12" (30cm) of each other and try synchronizing again.



1601 Jack McKay Blvd. • Ennis, Texas 75119 U.S.A.
Telephone: 800.876.3333 • Fax: 800.765.3435

Channel Setting

1. Use MENU button to go to the CHANNEL | FREQUENCY page (Fig 7).
2. Press and hold the SET button for 3 seconds, then the upper-right channel number will flash to allow changes to be made (Fig 8).
3. Press SET / MENU buttons to change the channel number. The frequency will change accordingly (Fig 9).
4. After 3 seconds of selecting a channel, it will be automatically saved (Fig 10).

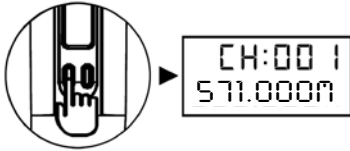

Figure 7

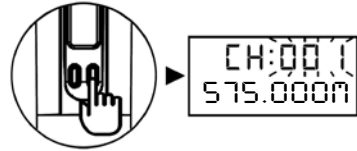

Figure 8

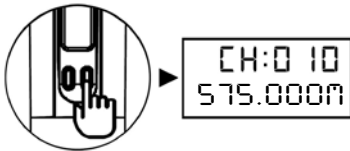

Figure 9



Figure 10

Battery Type Setting

1. Use MENU button to go to the BATTERY TYPE page (Fig 11).
2. Press and hold the SET button for 3 seconds, then the arrow cursor will flash to allow changes to be made (Fig 12).
3. Press SET button to select either NiMH (rechargeable battery) or AKLN (alkaline battery) (Fig 13).
4. After 3 seconds of selecting a battery type, it will be automatically saved (Fig 14).

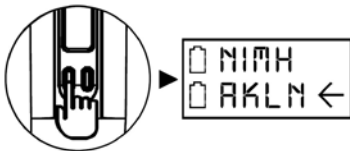

Figure 11

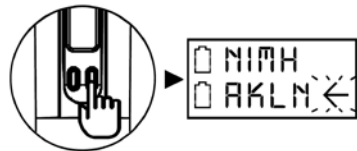

Figure 12

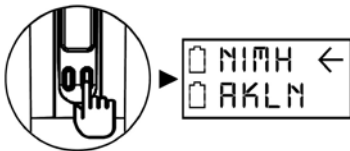

Figure 13



Figure 14

System	
Frequency Range	UHF 566 - 585.8MHz
Switching Bandwidth	25MHz
Switchable Frequency	100
2-way Synchronization	Yes
RF Power Output	< 10mW
Spurious Emission	> 60 dB Below Carrier
Dynamic Range	> 110 dB
Display Screen	LCD
T.H.D.	< 0.5%
Peak Deviation	±40KHz
Antenna	Built In
Battery Type	AA, Qty 2
Operating Life (Alkaline)	16 Hours
Charging Function	Yes
Battery Charger	MWCHGR
Microphone Capsule	Dynamic / Condenser Type
Mechanicals	
Dimensions	2.09" x 10.08" (53mm x 256mm)
Weight	0.66 lbs / 0.289 kg

This device complies with Part 15 of the FCC Rules. Operation is subject to the following two conditions:

(1) This device may not cause harmful interference, and (2) This device must accept any interference received, including interference that may cause undesired operation.

THIS DEVICE COMPLIES WITH PART 15C OF THE FCC RULES. This equipment complies with FCC RF radiation exposure limits set forth for an uncontrolled environment.



1601 Jack McKay Blvd. • Ennis, Texas 75119 U.S.A.
Telephone: 800.876.3333 • Fax: 800.765.3435

Limited Warranty

All products manufactured by AtlasIED are warranted to the original dealer/installer, industrial or commercial purchaser to be free from defects in material and workmanship and to be in compliance with our published specifications, if any. This warranty shall extend from the date of purchase for a period of three years on all AtlasIED products, including SOUNDOLIER brand, INNOVATIVE ELECTRONIC DESIGNS brand, and AtlasIED brand products except as follows: one year on electronics and control systems; one year on replacement parts; and one year on Musician Series stands and related accessories. Additionally, fuses and lamps carry no warranty. AtlasIED will solely at its discretion, replace at no charge or repair free of charge defective parts or products when the product has been applied and used in accordance with our published operation and installation instructions. We will not be responsible for defects caused by improper storage, misuse (including failure to provide reasonable and necessary maintenance), accident, abnormal atmospheres, water immersion, lightning discharge, or malfunctions when products have been modified or operated in excess of rated power, altered, serviced or installed in other than a workman like manner. The original sales invoice should be retained as evidence of purchase under the terms of this warranty. All warranty returns must comply with our returns policy set forth below. When products returned to AtlasIED do not qualify for repair or replacement under our warranty, repairs may be performed at prevailing costs for material and labor unless there is included with the returned product(s) a written request for an estimate of repair costs before any nonwarranty work is performed. In the event of replacement or upon completion of repairs, return shipment will be made with the transportation charges collect.

EXCEPT TO THE EXTENT THAT APPLICABLE LAW PREVENTS THE LIMITATION OF CONSEQUENTIAL DAMAGES FOR PERSONAL INJURY, ATLASIED SHALL NOT BE LIABLE IN TORT OR CONTRACT FOR ANY DIRECT, CONSEQUENTIAL OR INCIDENTAL LOSS OR DAMAGE ARISING OUT OF THE INSTALLATION, USE OR INABILITY TO USE THE PRODUCTS. THE ABOVE WARRANTY IS IN LIEU OF ALL OTHER WARRANTIES INCLUDING BUT NOT LIMITED TO WARRANTIES OF MERCHANTABILITY AND FITNESS FOR A PARTICULAR PURPOSE.

AtlasIED does not assume, or does it authorize any other person to assume or extend on its behalf, any other warranty, obligation, or liability. This warranty gives you specific legal rights and you may have other rights which vary from state to state.

Service

Should your MWHHM require service, please contact the AtlasIED warranty department at 1-877-689-8055, ext. 277 or www.atlasied.com/support to obtain an RA number.

AtlasIED Tech Support can be reached at 1-800-876-3333 or www.atlasied.com/support

Visit our website at www.AtlasIED.com to see other AtlasIED products.

©2018 AtlasIED. The Atlas "Circle A", Soundolier, and Atlas Sound are trademarks of Atlas Sound L.P. IED is a registered trademark of Innovative Electronic Designs LLC. All Rights Reserved. All other trademarks are the property of their respective owners. All specs are subject to change without notice. AT5005698 RevA 1/18



1601 Jack McKay Blvd. • Ennis, Texas 75119 U.S.A.
Telephone: 800.876.3333 • Fax: 800.765.3435