

Invacare® CS600 Bed Half Rails

CS600HALFRAILH, CS600HALFRAILF, CS600HALFRAILHEXP,
CS600HALFRAILFEXP

en

Long-Term Care Bed Accessory

Instruction Sheet

For more information regarding bed rail safety, refer to the
Bed Rail Entrapment Risk Notification Guide at
www.invacare.com



This manual **MUST** be given to the user of the product.
BEFORE using this product, this manual **MUST** be read and saved for
future reference.

Contents

1 Symbols	2
1.1 Symbols Used on the CS600 Bed	2
2 Label Locations	4
3 General Guidelines	7
3.1 Operation	8
3.2 Replacement Parts/Accessories	9
4 Installing the Half Rails	11
5 Limited Warranty	15

1 Symbols

Signal words are used in this manual and apply to hazards or unsafe practices which could result in personal injury or property damage. Refer to the table below for definitions of the signal words.







 **DANGER!**
-Danger indicates an imminently hazardous situation which, if not avoided, will result in death or serious injury.





 **WARNING!**
-Warning indicates a potentially hazardous situation which, if not avoided, could result in death or serious injury.

 **CAUTION!**
-Caution indicates a potentially hazardous situation which, if not avoided, may result in property damage.

 Gives useful tips, recommendations and information for efficient, trouble-free use.

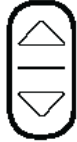
1.1 Symbols Used on the CS600 Bed

Symbol	Description
	Warning – Safe Working Load The Maximum allowable load on equipment if the instructions for installation and use are followed.
IP54	International Protection Code 54 denotes protection against dust and water spray from any direction.
CLASS I	Class I equipment classification in terms of protection against electrical shock.
	Battery status: <ul style="list-style-type: none"> • Yellow–Charging • Green–Fully charged
	Recycle this product. Refer to <i>1.1 Disposal, page 1</i> .
	Initiate action to the entire mattress support platform (HILO).
	Initiate action to head section of mattress support platform
	Toggle switch for one-touch head and knee-foot raise operation.

Symbol	Description
	<p>Initiate action to the knee-foot section of the mattress support platform</p>
	<p>Up Control – Raise the corresponding section of the mattress support platform. Down Control – Lower the corresponding section of the mattress support platform.</p>
	<p>General warning symbol (ISO 3864).</p>
	<p>Crush hazard symbol (based on ANSI Z535).</p>
	<p>Crush hazard symbol (based on ANSI Z535)</p>

2 Label Locations

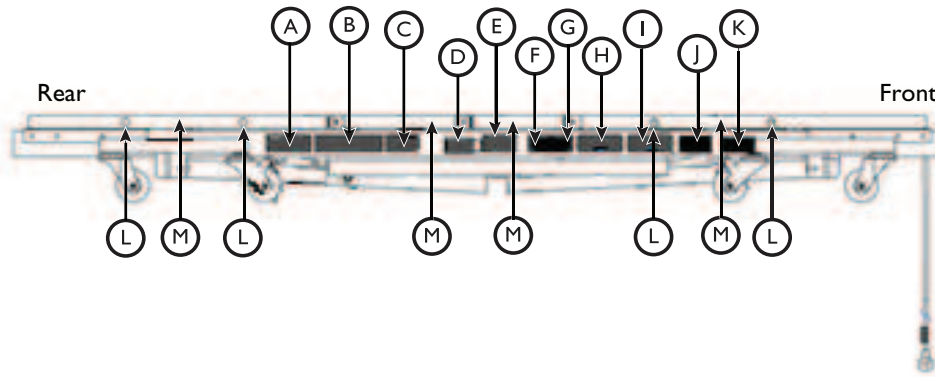
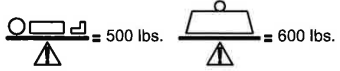

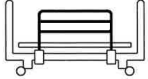









Fig. 2-1

Symbol	Label		
<p style="text-align: center;">Ⓐ</p>	<div style="border: 1px solid black; padding: 5px;"> <p>⚠ CAUTION: Unplug bed during service or cleaning. Bed is always electrified when connected to a power source. Disconnect power cord to de-energize bed.</p> <p>⚠ AVERTISSEMENT: Débranchez le lit pendant le nettoyage ou l'entretien. Ce lit est toujours électrifié quand branché au courant électrique. Débranchez le cordon avant de servir ou de nettoyer le lit.</p> <p style="text-align: right;">60136127-A</p> </div>		
<p style="text-align: center;">Ⓑ</p>	<div style="border: 1px solid black; padding: 5px;"> <p>⚠ CAUTION: Possible fire hazard when used with oxygen-administering equipment of other than the nasal, mask or 1/2 bed length tent type. Oxygen tent should not extend below mattress support level. Lock control at foot of bed when using oxygen-administering equipment.</p> <p>⚠ AVERTISSEMENT: Danger de feu quand utilisé avec de l'équipement qui se sert de l'oxygène, sauf pour l'équipement, nasal, masque, ou tente type demi-lit. La tente d'oxygène ne devrait pas étendre sous le niveau de soutien de matelas. Fermez à clé le contrôle à main au pied du lit lorsqu'on utilise en même temps ce produit avec de l'équipement à l'oxygène.</p> <p>⚠ DANGER: EXPLOSION HAZARD - Do not use in the presence of flammable anesthetics.</p> <p>⚠ DANGER: RISQUE D'EXPLOSION - Ne pas utiliser en présence des anesthésiques inflammables.</p> <p style="text-align: right;">60136131-A</p> </div>		
<p style="text-align: center;">Ⓒ</p>	<div style="border: 1px solid black; padding: 5px;"> <p>⚠ WARNING: Powered bed mechanisms can cause serious injury. Never permit anyone under the bed at any time. Disassembly of bed mechanism may cause bed to collapse. Prior to performing any work on mechanism, turn bed on its side.</p> <p>⚠ AVERTISSEMENT: Le mécanisme actionné mécaniquement du lit causer des blessures graves. Ne permettez personne sous le lit. Le désassemblage du mécanisme peut causer l'écroulement du lit. Avant de se mettre au travail sur ce lit, faut le mettre de côté.</p> <p style="text-align: right;">60136128-A</p> </div>		
<p style="text-align: center;">Ⓓ</p>	<div style="border: 1px solid black; padding: 5px; text-align: center;"> <p style="text-align: right;">60136136-A</p> </div> <p style="text-align: center;">Minimum user weight, height, and Body Mass Index (BMI)</p>		
<p style="text-align: center;">Ⓔ</p>	<div style="border: 1px solid black; padding: 5px;"> <table style="width: 100%; border-collapse: collapse;"> <tr> <td style="width: 50%; border-right: 1px solid black; padding: 5px;"> <p>⚠ AVERTISSEMENT</p> <p>Risque d'écrasement dû à la basse distance à la terre. Garder loin du fond du lit. Ne pas permettre les enfants et les animaux domestique sous le lit. Garder loin des pièces mobiles, et LES POINTS DE PINCEMENT au-dessous de la plateforme de matelas et à côté des attachements fixes.</p> </td> <td style="width: 50%; padding: 5px;"> <p>⚠ WARNING</p> <p>Crush Hazard due to LOW BED CLEARANCE. Stay clear of frame and ensure children and pets are not under or near the frame before lowering the bed. Beware of PINCH POINTS below deck panels, next to fixed attachments and between moving parts.</p> <p style="text-align: right;">60136129-A</p> </td> </tr> </table> </div>	<p>⚠ AVERTISSEMENT</p> <p>Risque d'écrasement dû à la basse distance à la terre. Garder loin du fond du lit. Ne pas permettre les enfants et les animaux domestique sous le lit. Garder loin des pièces mobiles, et LES POINTS DE PINCEMENT au-dessous de la plateforme de matelas et à côté des attachements fixes.</p>	<p>⚠ WARNING</p> <p>Crush Hazard due to LOW BED CLEARANCE. Stay clear of frame and ensure children and pets are not under or near the frame before lowering the bed. Beware of PINCH POINTS below deck panels, next to fixed attachments and between moving parts.</p> <p style="text-align: right;">60136129-A</p>
<p>⚠ AVERTISSEMENT</p> <p>Risque d'écrasement dû à la basse distance à la terre. Garder loin du fond du lit. Ne pas permettre les enfants et les animaux domestique sous le lit. Garder loin des pièces mobiles, et LES POINTS DE PINCEMENT au-dessous de la plateforme de matelas et à côté des attachements fixes.</p>	<p>⚠ WARNING</p> <p>Crush Hazard due to LOW BED CLEARANCE. Stay clear of frame and ensure children and pets are not under or near the frame before lowering the bed. Beware of PINCH POINTS below deck panels, next to fixed attachments and between moving parts.</p> <p style="text-align: right;">60136129-A</p>		

Symbol	Label
<p>Ⓕ</p>	<div data-bbox="867 233 1227 411" style="border: 1px solid black; padding: 5px; text-align: center;">  <p>Max patient weight may be less than stated if more than 100 lbs of accessories (mattress, assists, width kits, end panels, bedding, etc.) are placed on the bed frame.</p> <p>60136132-A</p> </div> <ul style="list-style-type: none"> • Maximum user weight (500 lb) • Maximum weight limit including the user and accessories (600 lb)
<p>Ⓖ</p>	<div data-bbox="782 562 1308 758" style="border: 1px solid black; padding: 10px;"> <p>⚠ WARNING - RISK OF ENTRAPMENT OR FALLS Incompatible SIDE RAILS can create HAZARDS. Read instructions for use.</p> <p>⚠ AVERTISSEMENT - RISQUE DE PIÉGEAGE OU DE CHUTE Les BARRIÈRES LATÉRALES incompatibles peuvent créer les DANGERS. Lire les instructions d'utilisation.</p> <p style="text-align: right;">60136133-A</p> </div>
<p>Ⓗ</p>	<div data-bbox="867 800 1227 940" style="border: 1px solid black; padding: 5px; text-align: center;">   <p>DETACHABLE SIDE RAILS</p> <p>60136134-A</p> </div>
<p>Ⓘ</p>	<div data-bbox="792 982 1302 1171" style="border: 1px solid black; padding: 10px;"> <p>⚠ WARNING - RISK OF ENTRAPMENT Incompatible mattresses can create HAZARDS. Read instructions for use.</p> <p>⚠ AVERTISSEMENT - RISQUE DE PIÉGEAGE Les matelas incompatibles peuvent créer les DANGERS. Lire les instructions d'utilisation.</p> <p style="text-align: right;">60136135-A</p> </div>
<p>Ⓙ (tag attached to deck and frame)</p>	<div data-bbox="847 1213 1247 1465" style="border: 1px solid black; padding: 10px;"> <p>⚠ WARNING</p> <p>Do not cut red cable ties with the bed in the vertical position. The cable ties hold the deck in place for shipping.</p> <ul style="list-style-type: none"> • The deck could free fall and could result in injury if the red ties are cut. <p>Lower the bed into the horizontal position resting on its casters before cutting the red cable ties.</p> <p style="text-align: right;">60136130-A</p> </div>
<p>Ⓚ</p>	<div style="display: flex; justify-content: space-between;"> <div data-bbox="578 1503 1036 1724" style="border: 1px solid black; padding: 5px;"> <p>CS600 Bed, Standard width 36" W by 80" L CS600 Le lit, Largeur standard 36" W by 80" L</p> <p>Model CS600-36 Modèle CS600-36</p> <p style="font-size: small;">Made in China / Fabriqué en Chine</p>  <p>(01)XXXXXXXX(21)23FKM000001 Manufactured for Invacare Corporation</p> <p style="text-align: right;">INVACARE Yes, you can.</p> <p>Invacare Corporation One Invacare Way Elyria, Ohio USA 44035 800-333-6900</p> </div> <div data-bbox="1052 1503 1516 1724" style="border: 1px solid black; padding: 5px;"> <p>CS600 Bed, Expandable width 36", 39" and 42" W by 80" L CS600 Le lit, Largeur extensible 36", 39" and 42" W by 80" L</p> <p>Model CS600-EXP Modèle CS600-EXP</p> <p style="font-size: small;">Made in China / Fabriqué en Chine</p>  <p>(01)XXXXXXXX(21)23FKM000001 Manufactured for Invacare Corporation</p> <p style="text-align: right;">INVACARE Yes, you can.</p> <p>Invacare Corporation One Invacare Way Elyria, Ohio USA 44035 800-333-6900</p> </div> </div>
<p>Ⓛ</p>	<div style="text-align: center;">  <p>(green circle)</p> <p>Side rail alignment indicators.</p> </div>

Symbol	Label
	<div style="display: flex; justify-content: space-around; align-items: center;"> <div style="border: 1px solid black; padding: 5px; text-align: center;"> CAUTION! PINCH POINTS Attention! Point de pincement <small>60136137-A</small>  </div> <div style="border: 1px solid black; padding: 5px; text-align: center;"> CAUTION! PINCH POINTS Attention! Point de pincement <small>60136139-A</small>  </div> </div> <p style="text-align: center;">Pinch-point warnings in different sizes based on location.</p>
<p>not shown</p>	<div style="text-align: center; margin-bottom: 10px;"> 80 " 84 " </div> <p>Length Extension</p> <ul style="list-style-type: none"> 80 inches 84 inches
<p>not shown</p>	<div style="text-align: center; margin-bottom: 10px;"> 42 " <input type="radio"/> 39 " <input type="radio"/> 36 " <input type="radio"/> / 36 " <input type="radio"/> 39 " <input type="radio"/> 42 " <input type="radio"/> </div> <p style="text-align: center;">Left/Right</p> <p>Width Extension (CS600-EXP only):</p> <ul style="list-style-type: none"> 42 inches 39 inches 36 inches <p>Refer to <i>Expanding the Deck</i> in the CS600 Bed User Manual (P/N 60131107).</p>
<p>not shown (on caster support)</p>	<div style="text-align: center; margin-bottom: 10px;">  </div> <p>No stepping</p>
<p>not shown (on deck corners)</p>	<div style="text-align: center; border: 1px solid black; padding: 10px; background-color: #f0f0f0;"> <p>⚠ WARNING</p> <p>MATTRESS KEEPERS MUST BE INSTALLED</p> <p style="text-align: right; font-size: small;">60133760-A</p> </div>
<p>not shown (on side rails)</p>	<div style="border: 1px solid gray; padding: 10px;"> <div style="display: flex; justify-content: space-between; align-items: center; border-bottom: 1px solid gray; margin-bottom: 5px;"> <div style="text-align: center;"> <p><small>● HEAD END PIN HOLE</small></p> <div style="display: flex; align-items: center;"> <div style="border: 1px solid gray; padding: 2px; text-align: center; font-size: x-small;"> YES NO <input type="checkbox"/> <input type="checkbox"/> NO NO </div> <div style="font-size: 2em; margin: 0 10px;">A</div> <div style="flex-grow: 1; border-bottom: 2px solid black; position: relative;"> <div style="position: absolute; right: -10px; top: -5px;">➔</div> </div> <div style="text-align: right;"> <p><small>● HEAD END PIN HOLE</small></p> <p>CENTER OF BED</p> </div> </div> </div> <div style="display: flex; justify-content: space-between; align-items: center; border-bottom: 1px solid gray; margin-bottom: 5px;"> <div style="text-align: center;"> <p><small>● HEAD END PIN HOLE</small></p> <p>CENTER OF BED</p> </div> <div style="flex-grow: 1; border-bottom: 2px solid black; position: relative;"> <div style="position: absolute; left: -10px; top: -5px;">➔</div> </div> <div style="text-align: right;"> <p><small>● HEAD END PIN HOLE</small></p> <p>CENTER OF BED</p> </div> </div> </div> <div style="display: flex; justify-content: space-between; align-items: center; border-bottom: 1px solid gray; margin-bottom: 5px;"> <div style="text-align: center;"> <p><small>● FOOT END PIN HOLE</small></p> <p>CENTER OF BED</p> </div> <div style="flex-grow: 1; border-bottom: 2px solid black; position: relative;"> <div style="position: absolute; left: -10px; top: -5px;">➔</div> </div> <div style="text-align: right;"> <p><small>● FOOT END PIN HOLE</small></p> <p>CENTER OF BED</p> </div> </div> <div style="display: flex; justify-content: space-between; align-items: center;"> <div style="text-align: center;"> <p><small>● FOOT END PIN HOLE</small></p> <p>CENTER OF BED</p> </div> <div style="flex-grow: 1; border-bottom: 2px solid black; position: relative;"> <div style="position: absolute; right: -10px; top: -5px;">➔</div> </div> <div style="text-align: right;"> <p><small>● FOOT END PIN HOLE</small></p> <p>CENTER OF BED</p> </div> </div> </div> <p>Side rail installation aids.</p>

3 General Guidelines



DANGER!

Risk of Death, Injury, or Damage

Improper use of this product may cause injury or damage.

- If you are unable to understand the warnings, cautions, or instructions, contact a healthcare professional, dealer or technical personnel before attempting to use this equipment.
 - Do not use this product or any available optional equipment without first completely reading and understanding these instructions and any additional instructional material such as user manuals, service manuals or instruction sheets supplied with this product or optional equipment.
- Continued use of the product with damaged parts could lead to the product malfunctioning, causing injury to the user and/or caregiver.
- Check ALL product components and carton for damage, and test components before use. DO NOT use product if components are damaged or if product is not working properly. Contact a qualified technician or Invacare for repair.



DANGER!

Risk of Death, Injury, or Damage

To avoid injury or product damage:

- Setup and assembly instructions MUST be performed by qualified technicians only. "Qualified Technician Only" sections are marked accordingly.

 THE INFORMATION CONTAINED IN THIS DOCUMENT IS SUBJECT TO CHANGE WITHOUT NOTICE.



DANGER!

Risk of Death, Injury, or Damage

Lighted cigarettes can cause a fire or other related hazards resulting in death, injury, or damage.

- Do not smoke while using this product.
- Do not allow others to smoke near this product.



DANGER!

Risk of Death, Injury, or Damage

Bed accessories designed by other manufacturers have NOT been tested by Invacare. Use of NON-Invacare bed accessories may result in injury or death.

- Use ONLY Invacare rails, mattresses, bed extenders, and other accessories with Invacare bed products.



DANGER!

Risk of Death, Injury or Damage

Improper assembly may cause injury or damage.

- Use of incorrect or improper parts, including replacement (service) parts, may cause injury or damage.
- Replacement parts MUST match original Invacare parts.



DANGER!

Risk of Injury or Death

To reduce the risk of electrical shock:

- Always unplug the product from the electrical outlet before cleaning.



DANGER!

Risk of Death, Injury, or Damage

To reduce the risk of shock:

- Unplug from the outlet before servicing.
- Close supervision is necessary when the product is used by, or near children and/or disabled persons.
- Use this product only for its intended use as described in these instructions. DO NOT use attachments not recommended by the manufacturer.
- If liquid is spilled in or around the product, unplug before cleaning. Clean up the spill and allow the product or the area around the product to dry thoroughly before using the controls again.



DANGER!

Risk of Death, Injury, or Damage

To avoid shock, product damage and personal injury:

- DO NOT use outdoors.
- Connect this product to a properly grounded outlet only. Refer to *1 Operation, page 1*.
- DO NOT place video equipment such as televisions or computer monitors on the product.

3.1 Operation



DANGER!

Risk of Death, Injury, or Damage

To avoid injury or damage when operating the product:

- After any adjustments, repair or service and before use, make sure all attaching hardware is tightened securely.
- Close supervision is necessary when the product is used near children or pets OR when this product is operated by or near people with physical/mental disabilities. Physically challenged individuals who cannot prevent themselves from rolling/climbing out of the product may require alternative safe means of restraint.
- The product is not designed to be used as a user transport. When transporting a user, use an approved user transport. Otherwise, injury or damage may result.



DANGER!

Risk of Injury or Damage

To avoid injury or damage when operating or moving the bed:

- ALWAYS ensure the individual utilizing the bed is positioned properly within the confines of the bed. DO NOT let any extremities protrude over the side or between the bed rails when performing these functions.
- Be aware of potential pinch points when operating bed, rails, or other accessories.
- Make sure head and foot springs/sections are connected securely to the bed ends before use.
- Note the bed is equipped with locking casters. Before using the bed, test the wheel locks to ensure casters lock correctly. When transferring into or out of the bed, ALWAYS lock the casters. Even with casters properly locked, some flooring surfaces (such as tile or wood,) will allow the bed to move under some conditions. Using the bed on these types of surfaces MUST be evaluated by the care provider. DO NOT transfer the occupant if the bed is not stable. Otherwise, injury and/or damage may occur.
- DO NOT move the product with the locking casters in the LOCKED position.



DANGER!

Risk of Injury or Damage

Swivel and wheel rotation will allow bed motion with little or no resistance if the casters are not locked, which can result in loss of balance, falls, and personal injury.

- Note the one-touch locking mechanism can be used for most situations where locking casters are needed. However, movement near the head section of the bed may still result if force is applied. The bed will be most secure if the head casters are locked along with the one-touch lock.



DANGER!

Risk of Death, Injury, or Damage

To avoid pinch, crush, and collapse hazards from bed deck contact with objects under the bed:

- DO NOT place any objects or let any individual underneath the bed or in between the raised bed frame components at any time.
- To avoid the risk of death or injury from choking or ingestion of small parts or materials:
- Closely supervise children, pets, or individuals with physical/mental disabilities.



Refer to the **Bed Rail Entrapment Risk Notification Guide** at www.invacare.com for additional safety information.

**DANGER!****Risk of Death, Injury, or Damage**

User entrapment from the use of bed side rails may cause injury or death. To avoid user entrapment:

- Note the Invacare mattress MUST fit firmly against the bed frame AND bed side rails to prevent user entrapment. Follow the manufacturer's instructions. Monitor user frequently. Read and understand the User Manual prior to using the Invacare bed and bed rails. User manuals are available at www.invacare.com or your dealer.
- After any adjustments, repair or service and before use, make sure all attaching hardware is tightened securely.

**DANGER!****Risk of Death, Injury, or Damage**

Conditions such as restlessness, mental deterioration and dementia or seizure disorders (uncontrolled body movement), sleeping problems, and incontinence can significantly impact a user's risk of entrapment. Pediatric users or users with small body size may also have an increased risk of entrapment.

- Monitor users with these conditions frequently.
- Place the mattress deck in the flat position when left unattended.

**WARNING!****Risk of Injury or Adverse Health Consequences**

Fall hazard exists due to bed height.

- Always leave bed in lowest height when unattended.

**DANGER!****Risk of Death, Injury, or Damage**

To avoid product damage and/or personal injury from fall or entrapment:

- Invacare recommends the use of mattress keepers.

3.2 Replacement Parts/Accessories

**DANGER!****Risk of Death, Injury, or Damage**

To avoid fire hazards and tubing entanglement:

- Use masked- or nasal-type oxygen administering equipment only in conjunction with the manual/electric bed. The use of any other type of oxygen administering equipment can result in a fire hazard.
- When using nasal- or masked-type oxygen administering equipment, the oxygen or air tubing MUST be routed and secured properly to ensure the tubing does not become entangled and/or severed during normal operation of manual/electric bed.
- Do not use this bed in Active Treatment "Ether Environments."

**DANGER!****Risk of Death, Injury, or Damage**

To avoid fire hazards, injury, or damage:

- DO NOT use the product with flammable gases. Explosion may occur.

**WARNING!****Risk of Injury or Damage**

To avoid injury or damage from misuse or entrapment:

- Read and understand the instructions or label provided with mattress.
- If you do not understand the instructions or if instructions are missing, contact the mattress manufacturer.

**DANGER!****Risk of Death, Injury, or Damage**

To avoid entrapment, product damage, and/or personal injury:

- Invacare recommends the mattress be centered on the bed frame. Otherwise, individuals may become trapped between the bed rail and the bed frame.
- ALWAYS test to make sure the side rails are properly and securely in place before using. Otherwise, injury or damage may occur.



DANGER!

Risk of Injury or Adverse Health Consequences

Fall hazards exist due to the incorrect installation of bed rails.

-To avoid injury, ensure the Invacare bed rails are installed correctly and are securely attached to the bed while entering or exiting.

Fall hazards exist due to the use of non-Invacare bed rails. Non-Invacare bed rails are potentially incompatible with Invacare beds.

-To avoid injury, ensure only Invacare bed rails are used with Invacare beds at all times.

Fall hazards exist due to the use of non-Invacare mattresses. Non-Invacare mattresses are potentially incompatible with Invacare beds.

-To avoid injury, ensure only Invacare mattresses are used with Invacare beds at all times.



DANGER!

Risk of Death or Injury

An increased risk of user entrapment may occur over time due to mattress compression.

-Periodically monitor gaps between the bed, mattress, and/or bed rail. Where gaps occur, user entrapment is possible and the mattress should be replaced.



DANGER!

Risk of Death, Injury, or Damage

To avoid entrapment, product damage, and/or personal injury:

-When used with a bed, the bed rails DO NOT fall under any weight limitations. Bed rails can be deformed or broken if excessive side pressure is exerted on the bed rails. These bed rails are used for the purpose of preventing an individual from inadvertently rolling out of bed. The bed rails are not intended and are not to be used for restraint purposes. If an individual is capable of injuring himself/herself, a physician or a healthcare professional should be consulted for alternative means of safe restraint.

-After raising/lowering the head/foot end of the electric bed, check the distance between the bottom of the bed rail and the mattress. If there is excessive distance between the bottom of the bed rail and the mattress in which individuals may become entangled, adjust the height of the bed rail (if applicable), or provide alternative means of user protection.

-DO NOT use the side rails as push handles for moving the bed.

-Replacement mattresses and bed side rails with dimensions different from the original equipment supplied or specified by the bed frame manufacturer are not interchangeable. Variations in bed side rail design, width and thickness or firmness of the mattress could cause/contribute to entrapment.



DANGER!

Risk of Death, Injury, or Damage

To avoid injury or damage from misuse or entrapment:

-Proper user assessment and monitoring, and proper maintenance and use of equipment is required to reduce the risk of entrapment. Variations in bed rail dimensions and mattress thickness, size or density could increase the risk of entrapment. Visit the FDA website at <http://www.fda.gov> to learn about the risks of entrapment, including "A Guide to Bed Safety". Use the links located under each bed rail product at <http://www.invacare.com> to access the Bed Rail Entrapment Risk Notification Guide and other product safety information and instructions.

-Refer to the user manuals for beds and rails for additional product and safety information.

-User entrapment from the use of bed side rails may cause injury or death. The Invacare mattress MUST fit firmly against the bed frame AND bed side rails to prevent user entrapment. Follow the manufacturer's instructions. Monitor user frequently. Read and understand the User Manual prior to using this equipment. Invacare manuals are available at www.invacare.com or your dealer.

-An increased risk of user entrapment may occur over time due to mattress compression. Periodically monitor gaps between the bed, mattress, and/or bed rail. Where gaps occur, user entrapment is possible and the mattress should be replaced.

4 Installing the Half Rails

The CS600-36 assist rail kit includes:

- Two half rails (A)
- Four mounting rods (B)
 - ⓘ Mounting rods differ between the CS600 and CS600-EXP beds.
- Four bolts (C)
- Clips (D)
 - Eight for CS600
 - Twelve for CS600-EXP

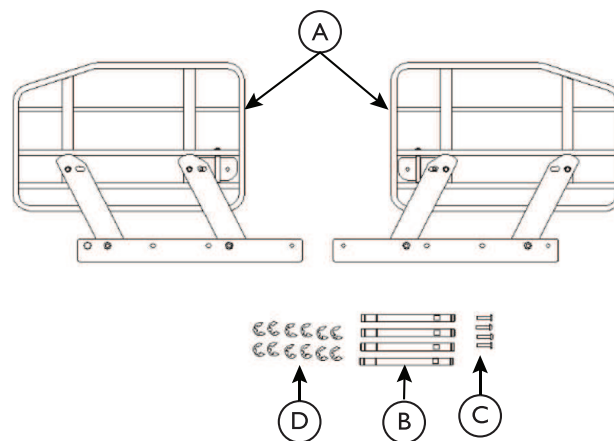

Fig. 4-1 Half Rail Kit (CS600-EXP Kit shown)

To install the half rails:

1. Do one of the following:

- For CS600 beds, insert the mounting rods **B** into mounting holes 1 and 3 on the left side of the head end frame.

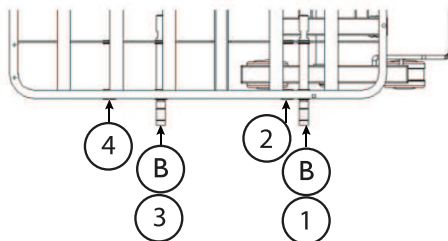

Fig. 4-2

- For CS600-EXP beds, insert the mounting rods **B** into the mounting holes on the left side of the head end frame.

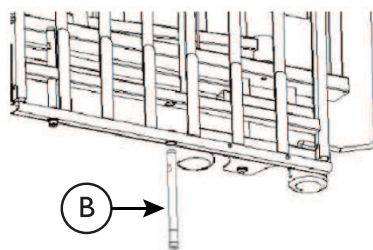

Fig. 4-3

2. Attach the fix clips as follows:

- On the CS600-EXP bed, attach the fix clips **D** on the three grooves on each mounting rod.

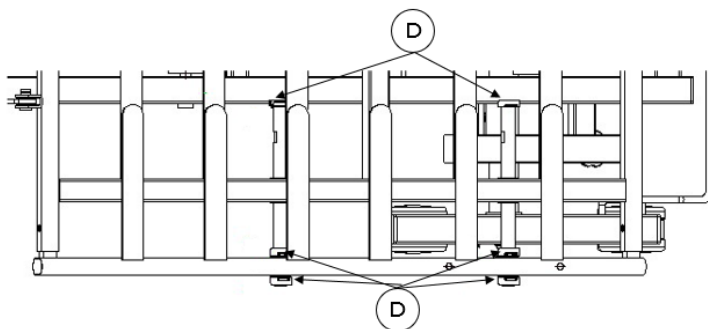
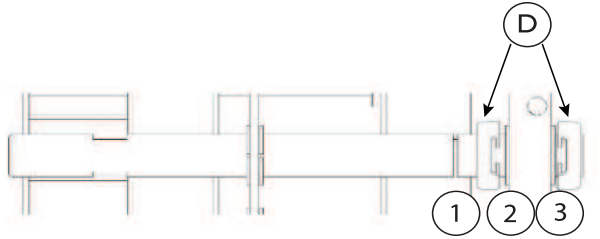
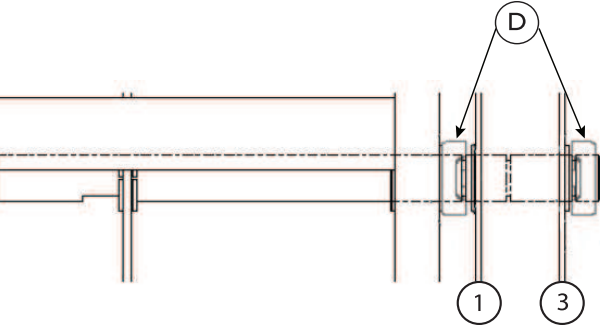
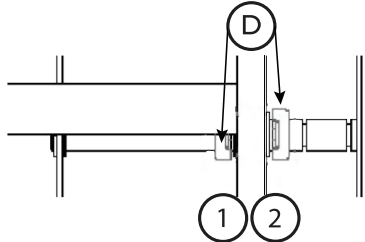

Fig. 4-4

- On the CS600 bed, attach the fix clips ④ on each mounting rod groove as listed in the following table.

Bed Width (inches)	Grooves	Image
36	2 and 3	
39	1 and 3	
42	1 and 2	

- Place two bolts ③ into the holes in the rail ④.

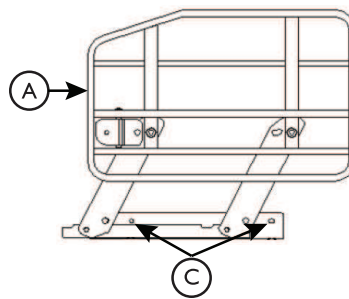

Fig. 4-5

- Align the rail **A** with the mounting rods, and use the provided Allen key to tighten the bolts **C**.

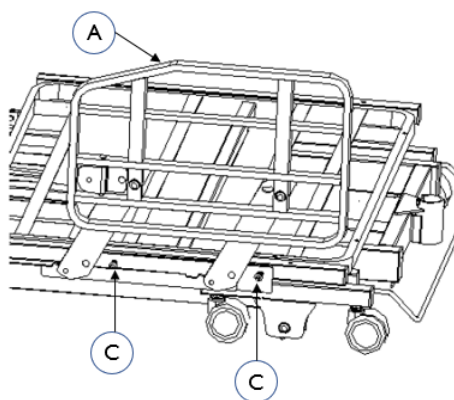

Fig. 4-6

- Repeat the previous steps 1-4 to install the other half rail.
- To lower the rail, press the release button **E** and pull down the half rail **A**.

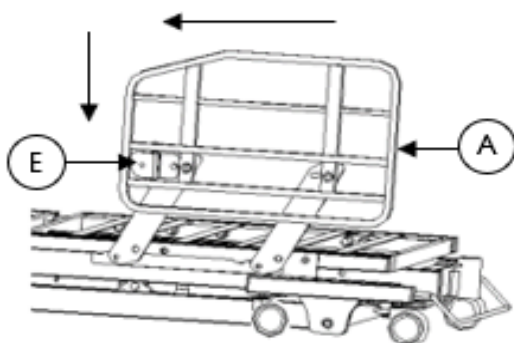

Fig. 4-7

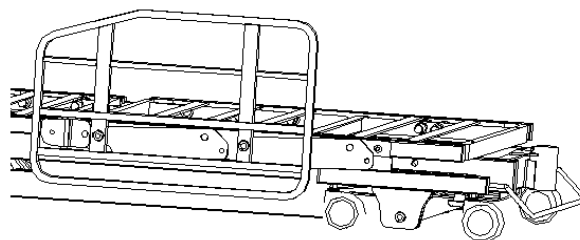

Fig. 4-8

- To raise the rail, pull up the assist handle **A**. The rail audibly clicks when it is properly positioned.

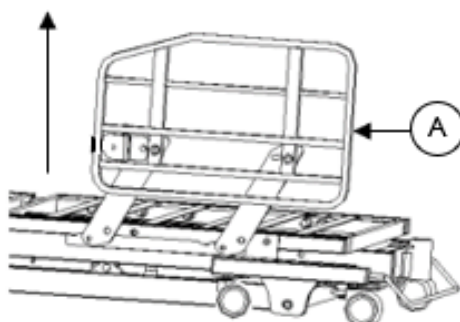

Fig. 4-9

5 Limited Warranty

PLEASE NOTE: THE WARRANTY BELOW HAS BEEN DRAFTED TO COMPLY WITH FEDERAL LAW APPLICABLE TO PRODUCTS MANUFACTURED AFTER JULY 4, 1975.

This warranty is extended only to the original purchaser who purchases this product when new and unused from Invacare or a dealer. This warranty is not extended to any other person or entity and is not transferable or assignable to any subsequent purchaser or owner. Coverage under this warranty will end upon any such subsequent sale or other transfer of title to any other person.

This warranty gives you specific legal rights and you may also have other legal rights which vary from state to state. Invacare warrants the mechanical and electrical components of this product when purchased new and unused to be free from defects in materials and workmanship for a period of one or two years from date of purchase from Invacare or a dealer, with a copy of the seller's invoice required for coverage under this warranty. The components warranty periods are listed in the following table:

Component	Warranty Period (Years)
Actuator	2
Control box	1
Hand pendant	1
Frame	2

Invacare warrants all welds of this product when purchased new and unused to be free from defects in materials and workmanship for a period of five years from date of purchase from Invacare or a dealer, with a copy of the seller's invoice required for coverage under this warranty. If within such warranty periods any such product shall be proven to be defective, such product shall be repaired or replaced, at Invacare's option. This warranty does not include any labor or shipping charges incurred in replacement part installation or repair of any such product. Invacare's sole obligation and your exclusive remedy under this warranty shall be limited to such repair and/or replacement.

For warranty service, please contact the dealer from whom you purchased your Invacare product. In the event you do not receive satisfactory warranty service, please write directly to Invacare at the address on the back cover, provide dealer's name, address, and the date of purchase, indicate nature of the defect and, if the product is serialized, indicate the serial number. Do not return products to our factory without our prior consent.

LIMITATIONS AND EXCLUSIONS: THE FOREGOING WARRANTY SHALL NOT APPLY TO SERIAL NUMBERED PRODUCTS IF THE SERIAL NUMBER HAS BEEN REMOVED OR DEFACED, PRODUCTS SUBJECTED TO NEGLIGENCE, ACCIDENT, IMPROPER OPERATION, MAINTENANCE OR STORAGE, PRODUCTS MODIFIED WITHOUT INVACARE'S EXPRESS WRITTEN CONSENT (INCLUDING, BUT NOT LIMITED TO, MODIFICATION THROUGH THE USE OF UNAUTHORIZED PARTS OR ATTACHMENTS; PRODUCTS DAMAGED BY REASON OF REPAIRS MADE TO ANY COMPONENT WITHOUT THE SPECIFIC CONSENT OF INVACARE, OR TO A PRODUCT DAMAGED BY CIRCUMSTANCES BEYOND INVACARE'S CONTROL, AND SUCH EVALUATION WILL BE SOLELY DETERMINED BY INVACARE. THE WARRANTY SHALL NOT APPLY TO MISUSE, NEGLIGENCE. OR NORMAL WEAR AND TEAR OR FAILURE TO ADHERE TO THE PRODUCT INSTRUCTIONS.

THE WARRANTY DOES NOT EXTEND TO NON-DURABLE COMPONENTS, SUCH AS RUBBER ACCESSORIES AND CASTERS, WHICH ARE SUBJECT TO NORMAL WEAR AND REQUIRE PERIODIC REPLACEMENT.

THE FOREGOING EXPRESS WARRANTY IS EXCLUSIVE AND IN LIEU OF ANY OTHER WARRANTIES WHATSOEVER, WHETHER EXPRESS OR IMPLIED, INCLUDING THE IMPLIED WARRANTIES OF MERCHANTABILITY AND FITNESS FOR A PARTICULAR PURPOSE, AND THE SOLE REMEDY FOR VIOLATIONS OF ANY WARRANTY WHATSOEVER, SHALL BE LIMITED TO REPAIR OR REPLACEMENT OF THE DEFECTIVE PRODUCT PURSUANT TO THE TERMS CONTAINED HEREIN. THE APPLICATION OF ANY IMPLIED WARRANTY WHATSOEVER SHALL NOT EXTEND BEYOND THE DURATION OF THE EXPRESS WARRANTY PROVIDED HEREIN. INVACARE SHALL NOT BE LIABLE FOR ANY CONSEQUENTIAL OR INCIDENTAL DAMAGES WHATSOEVER.

Some states do not allow the exclusion or limitation of incidental or consequential damage, or limitation of how long an implied warranty lasts, so the above exclusion and limitation may not be applicable.

THIS WARRANTY SHALL BE EXTENDED TO COMPLY WITH STATE/PROVINCIAL LAWS AND REQUIREMENTS.

Contact Information



United States

Invacare Corporation • One Invacare Way, Elyria, Ohio 44035
• Tel: 800-333-6900 • www.invacare.com

Canada

Invacare Canada LP • 84 Citation Drive #14, Concord, Ontario
L4K 3C1 • Tel: 800-668-5324 • pro.invacare.ca

60136144-A
2023-09-22



Making Life's Experiences Possible®



Yes, you can.