

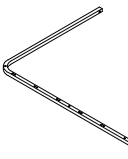









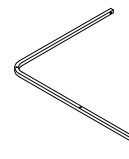
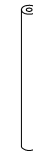

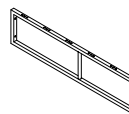
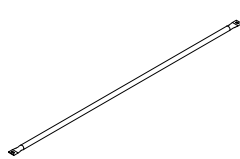

# ASSEMBLY INSTRUCTION

## METAL FULL BED FRAME / METAL QUEEN BED FRAME

<b>A</b> Rail Left Section  2PCS	<b>B</b> Rail Right Section  2PCS	<b>C</b> Rail Down Section  4PCS	<b>D</b> Rail Support Bar  8PCS
<b>E</b> Rail Side Connector Bar  2PCS	<b>F</b> Rail End Connector Bar  2PCS	<b>G</b> Center Support Rail  2PCS	<b>H</b> Slat  24PCS
<b>I</b> Slat Connector  20PCS	<b>J</b> Slat Connector - Middle  10PCS	<b>K</b> Bolt 1/4"*35mm  20PCS	<b>L</b> Bolt 1/4"*50mm  2PCS
<b>M</b> Bolt 1/4"*16mm  16PCS	<b>N</b> Bolt 3/16"*16mm  6PCS	<b>O</b> Nut 1/4"  2PCS	<b>P</b> Ratchet Tool 4mm  1PC
<b>Q</b> Wrench 1/4"  1PC			

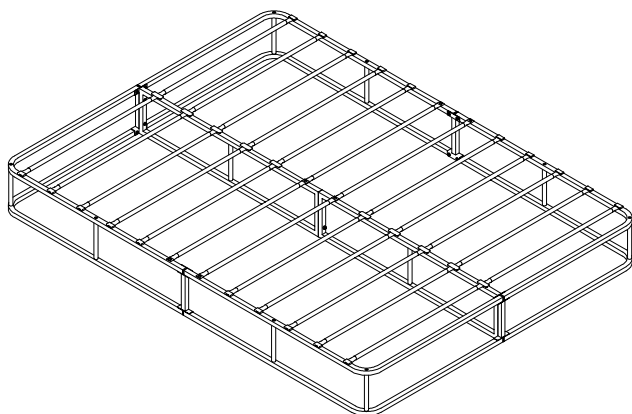

This page lists all the contents included in the box. Please take the time to identify the hardware as well as the individual components to this product. As you unpack and prepare for assembly, place the contents on a carpeted or padded area to protect them from damage.

# How to Use the Ratchet Tool (P)

1. Before assembling the furniture, please adjust the lock as needed.

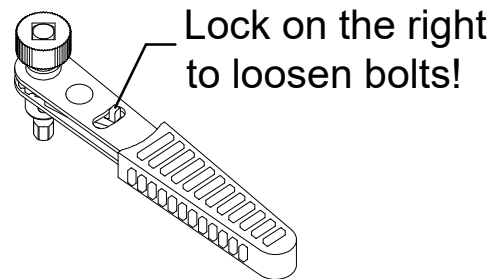
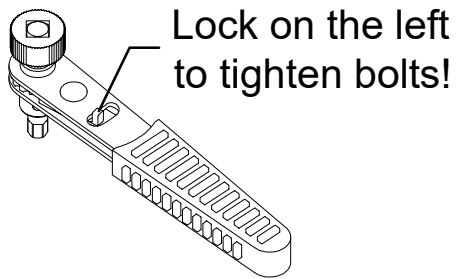

2. Tighten or loosen bolts.

- **Tighten bolts:** Locate the turncap and rotate it clockwise to screw the bolt quickly until it cannot be rotated any more. Then start rotating the handle clockwise to finalize tightening the bolt.

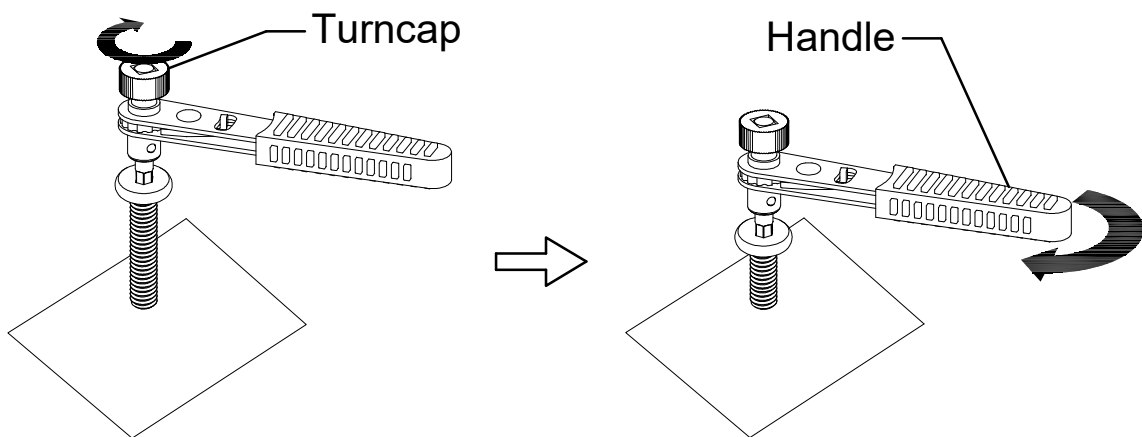

- **Loosen bolts:** Rotate the handle counterclockwise to loosen the bolt. Then continue rotating the turncap in the same direction to remove the bolt completely.

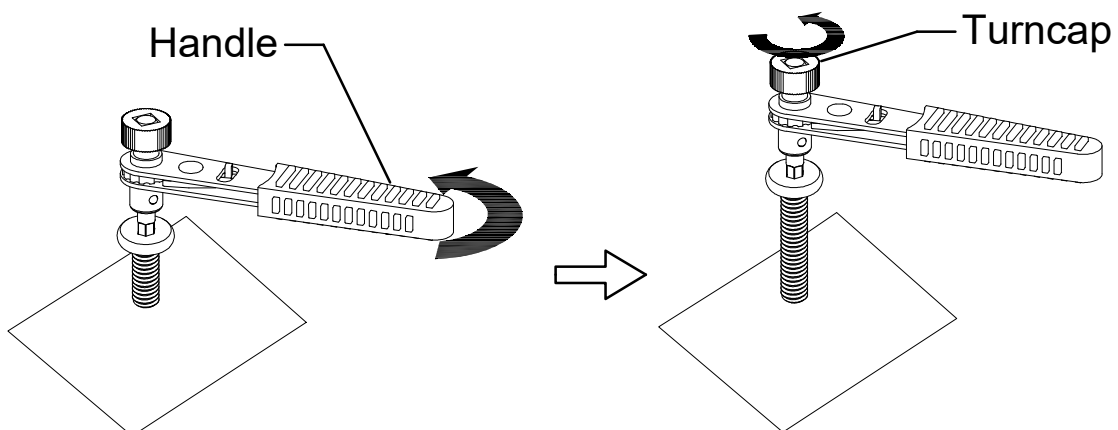

**1**

Attach Rail Support Bar (D) to Rail Sections (A) & (C), insert the Bolt (K), turn the Ratchet Tool (P) to tighten them. Attach Rail Support Bar (D) to Rail Sections (B) & (C), insert the Bolt (K), turn the Ratchet Tool (P) to tighten them.

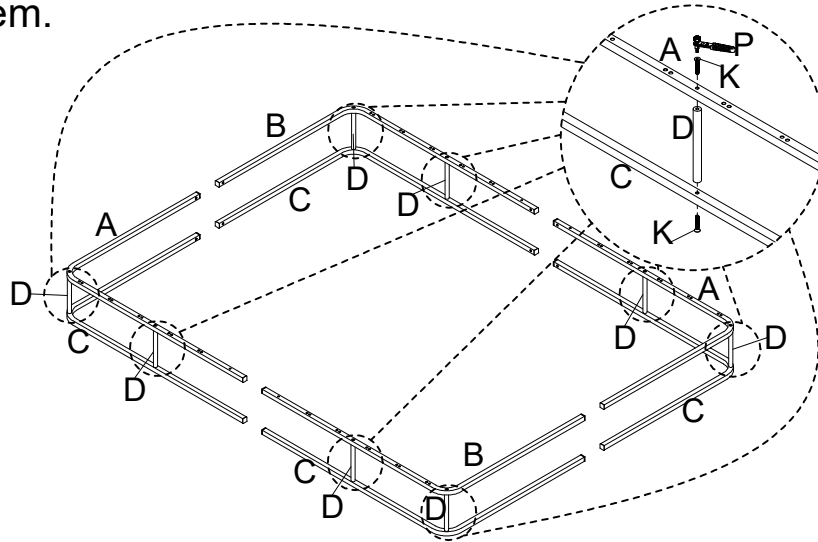
**2**

Attach the Rail End Connector Bar (F) to the assembled rails, insert the Bolt (M), turn the Ratchet Tool (P) to tighten them.

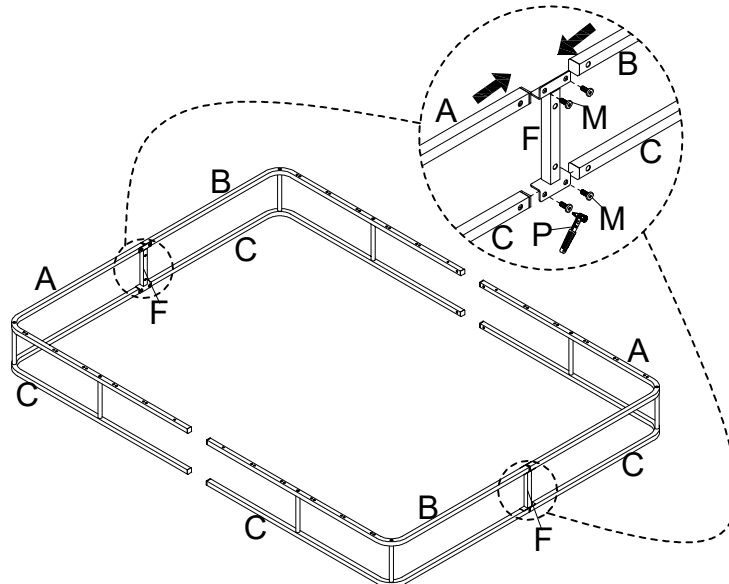
**3**

Attach the Center Support Rail (G) to the Rail End Connector Bar (F), insert the Bolt (K), turn the Ratchet Tool (P) to tighten them.  
NOTE: The side of the Center Support Rail (G) with a upward hole must be oriented toward the middle as indicated.

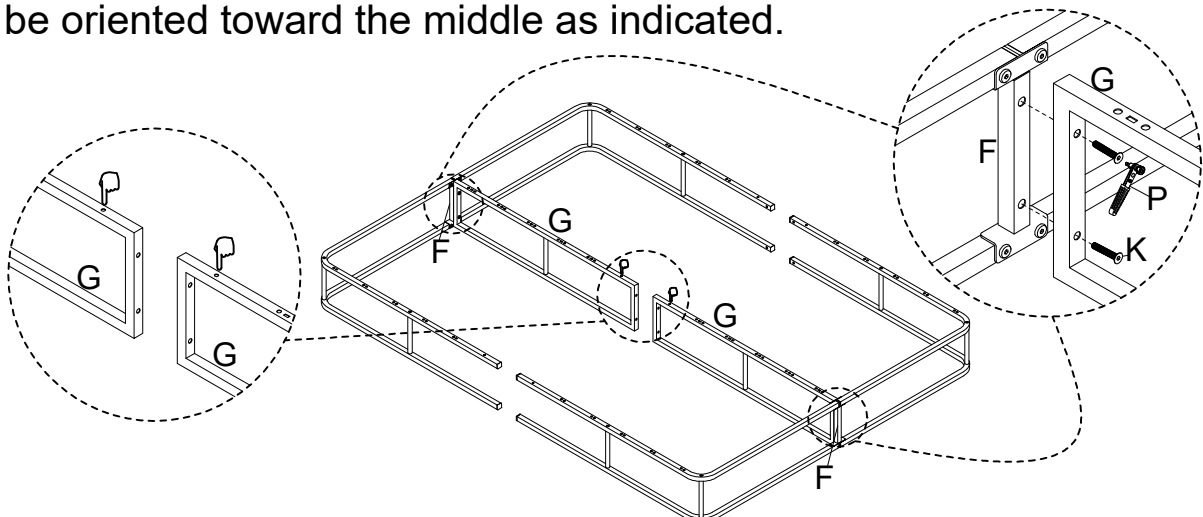

**4** Attach the Slat (H) to the Center Support Rail (G) and Rail Sections (A) & (B), insert the Bolt (N), turn the Ratchet Tool (P) to tighten them.

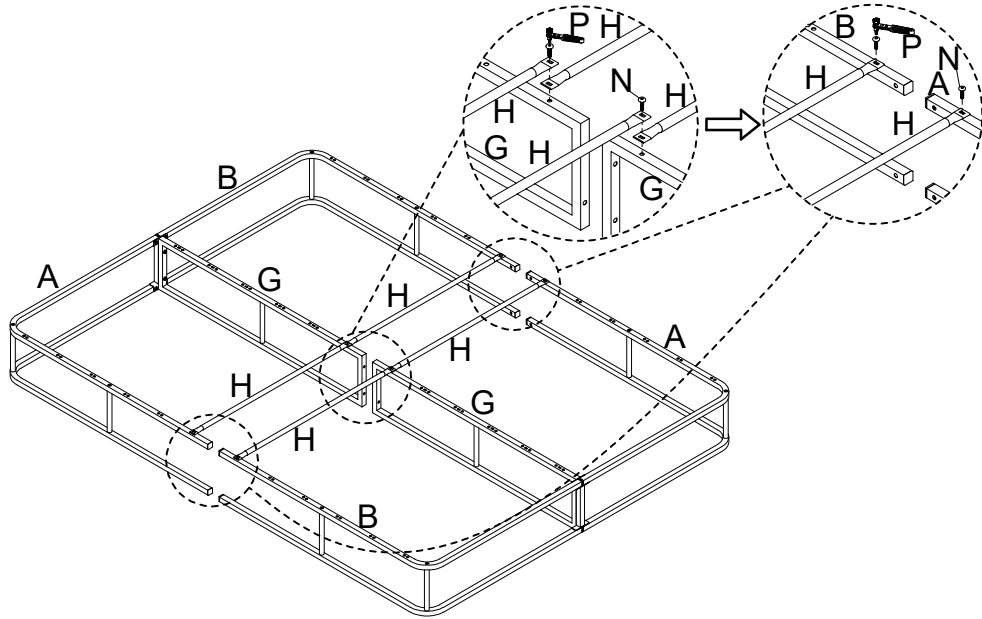

**5** Attach two Center Support Rail (G) together, insert the Bolt (L) and Nut (O), turn the Ratchet Tool (P) and Wrench (Q) to tighten them. Attach the Rail Side Connector Bar (E) to the assembled rails, insert the Bolt (M), turn the Ratchet Tool (P) to tighten them.

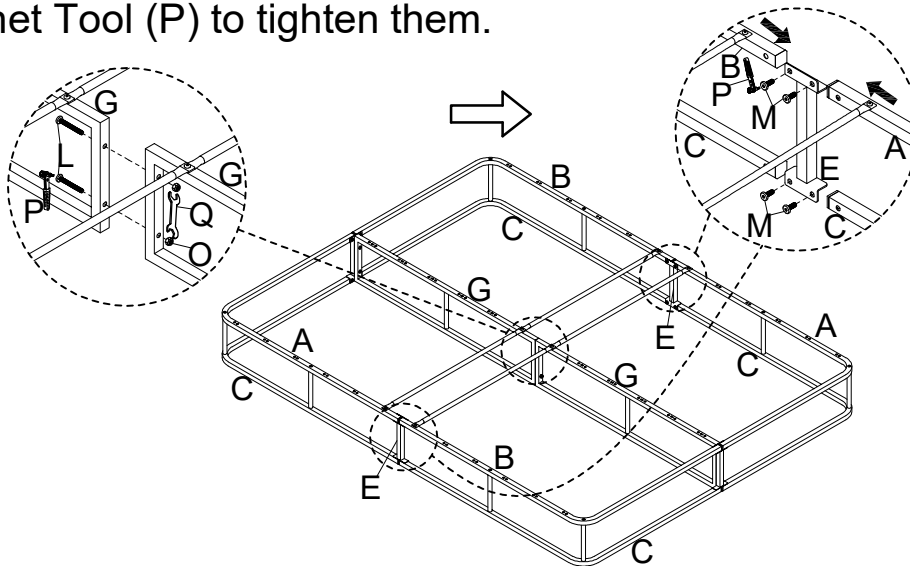

**6** Insert the Slat Connector (I) to one side of Slat (H), press the Slat (H) into the correct place.

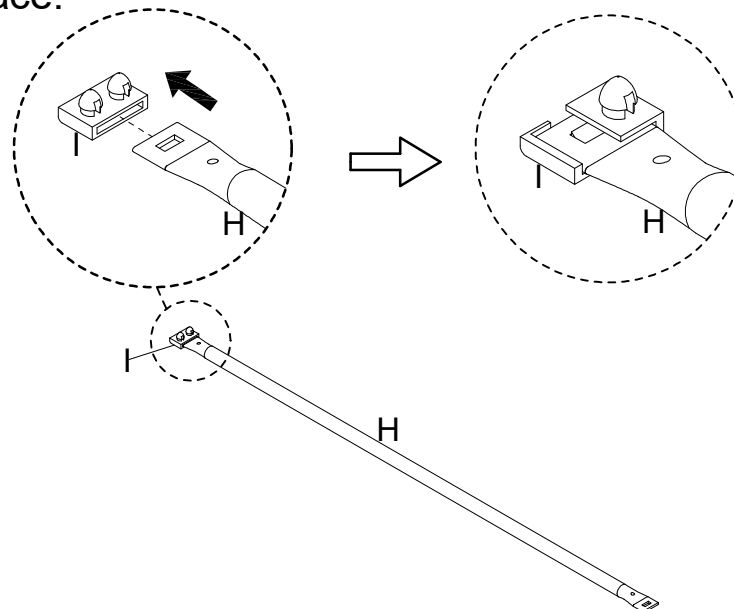

**7** Attach the Slat (H) to assembled rails, put the Slat Connectors (J) & (I) into the correct places and press them down.

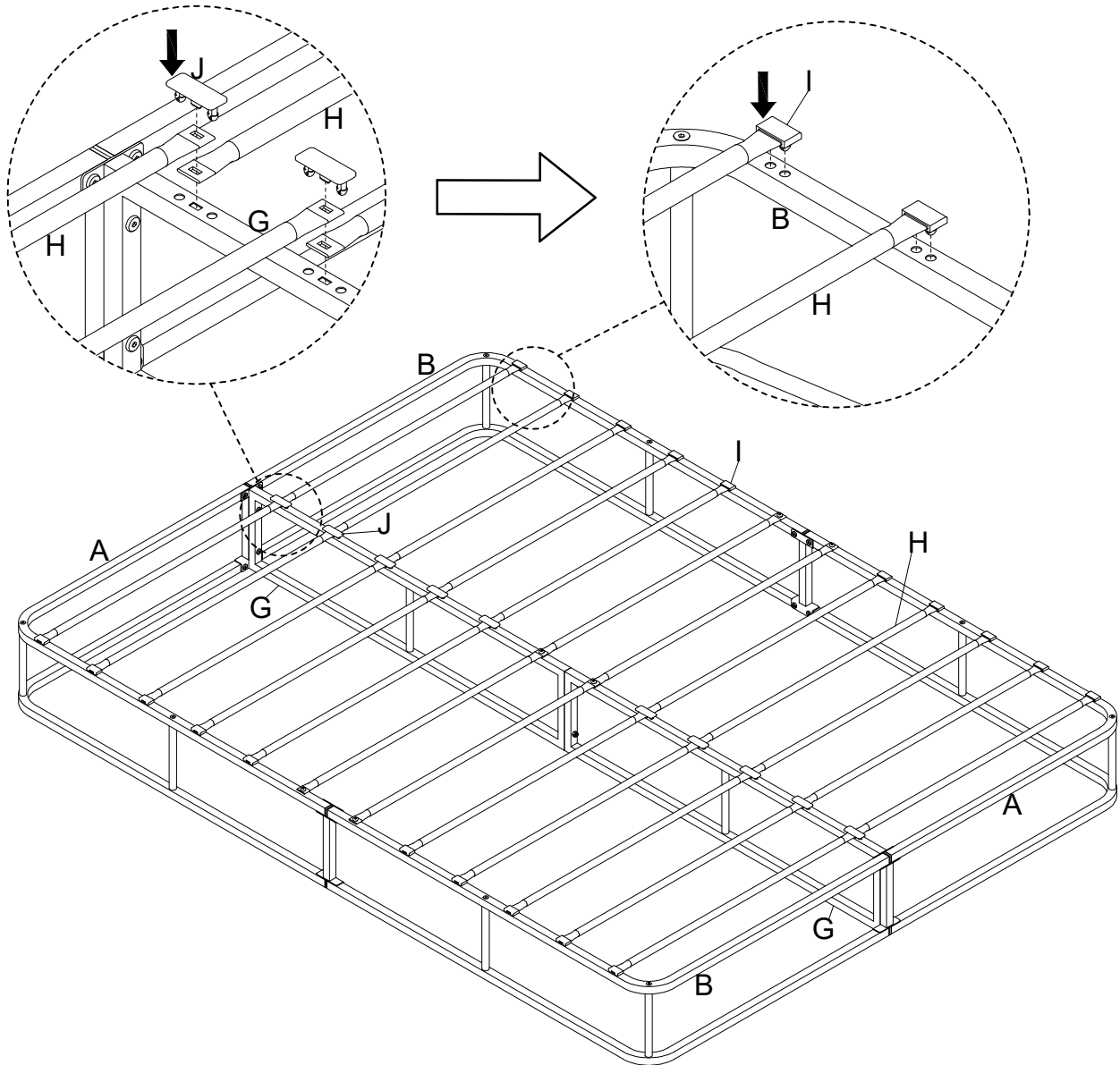

## Cleaning & Care

Treat surface with care. Surface is resistant to scratches but is not scratch resistant. Clean surfaces with a dry or damp soft cloth. Do not use abrasive cleaners. Hardware may loosen over time. Periodically check that all connections are tight.