

Kräus®

www.kraususa.com

Model No. KBU14/ KBU14E

Undermount Template

Pro Hotline: 516.801.8955

Customer Service: 800.775.0703

NOTE: Cutout template is provided as a guide **ONLY** and must be checked against actual sink to verify correct fit.

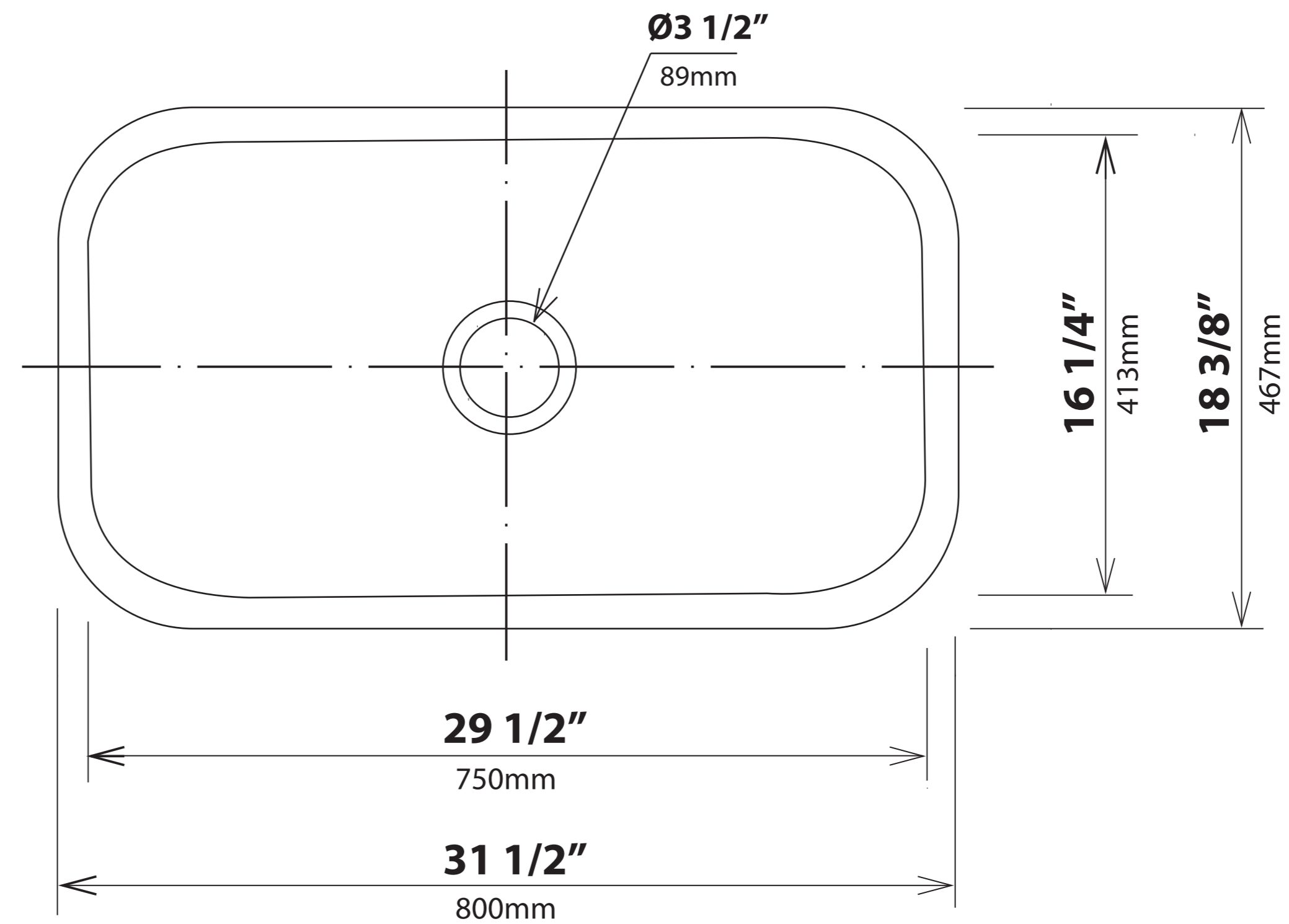

SPECIFICATION C: 3/8" POSITIVE REVEAL

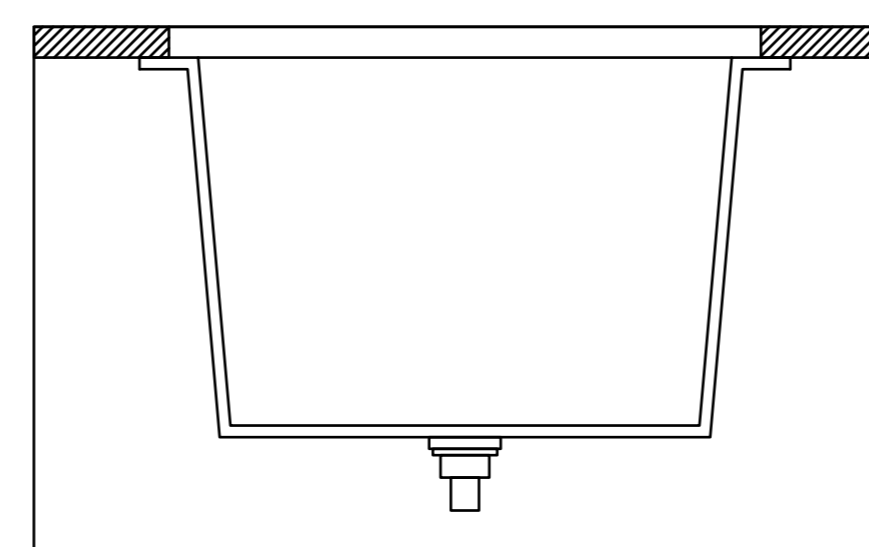

SPECIFICATION A: ZERO / FLUSH REVEAL

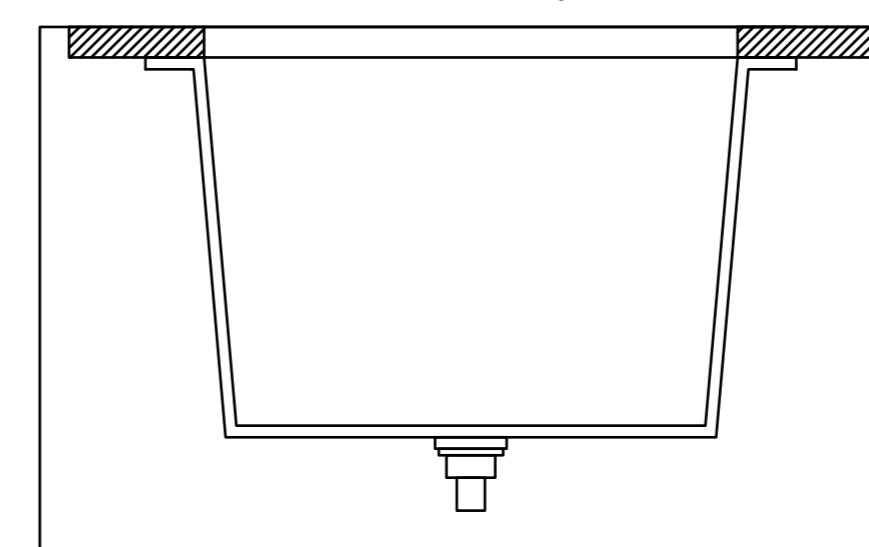

SPECIFICATION B: 1/8" NEGATIVE REVEAL

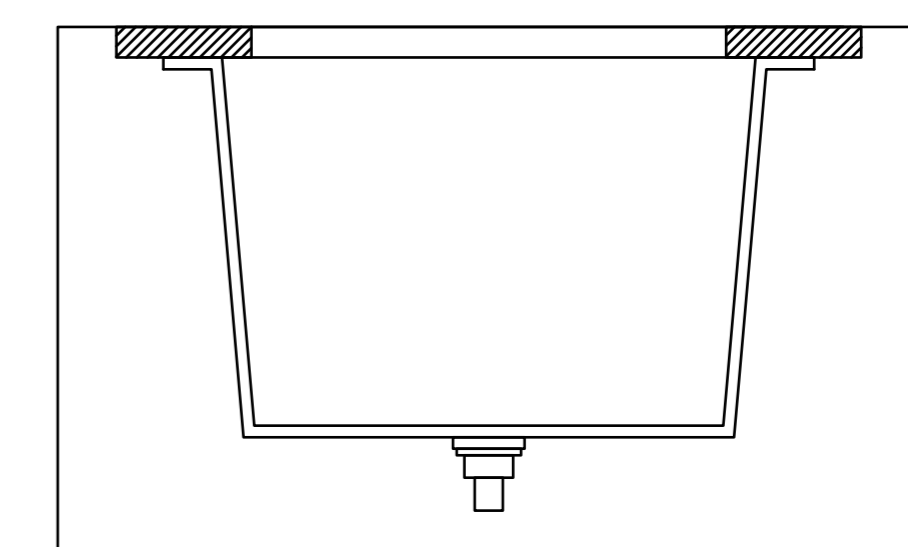

Please cut along inner solid line for negative reveal 1/8"

Please tear perforated edge for zero / flushed reveal

Please use outer edge for positive reveal 3/8"